

Oracle® Database Appliance

X5-2 Deployment and User's Guide



Release 19.10 for Linux x86-64

F37654-01

March 2021

The Oracle logo, consisting of a solid red square with the word "ORACLE" in white, uppercase, sans-serif font centered within it.

ORACLE®

Copyright © 2018, 2021, Oracle and/or its affiliates.

Primary Author: Aparna Kamath

This software and related documentation are provided under a license agreement containing restrictions on use and disclosure and are protected by intellectual property laws. Except as expressly permitted in your license agreement or allowed by law, you may not use, copy, reproduce, translate, broadcast, modify, license, transmit, distribute, exhibit, perform, publish, or display any part, in any form, or by any means. Reverse engineering, disassembly, or decompilation of this software, unless required by law for interoperability, is prohibited.

The information contained herein is subject to change without notice and is not warranted to be error-free. If you find any errors, please report them to us in writing.

If this is software or related documentation that is delivered to the U.S. Government or anyone licensing it on behalf of the U.S. Government, then the following notice is applicable:

U.S. GOVERNMENT END USERS: Oracle programs (including any operating system, integrated software, any programs embedded, installed or activated on delivered hardware, and modifications of such programs) and Oracle computer documentation or other Oracle data delivered to or accessed by U.S. Government end users are "commercial computer software" or "commercial computer software documentation" pursuant to the applicable Federal Acquisition Regulation and agency-specific supplemental regulations. As such, the use, reproduction, duplication, release, display, disclosure, modification, preparation of derivative works, and/or adaptation of i) Oracle programs (including any operating system, integrated software, any programs embedded, installed or activated on delivered hardware, and modifications of such programs), ii) Oracle computer documentation and/or iii) other Oracle data, is subject to the rights and limitations specified in the license contained in the applicable contract. The terms governing the U.S. Government's use of Oracle cloud services are defined by the applicable contract for such services. No other rights are granted to the U.S. Government.

This software or hardware is developed for general use in a variety of information management applications. It is not developed or intended for use in any inherently dangerous applications, including applications that may create a risk of personal injury. If you use this software or hardware in dangerous applications, then you shall be responsible to take all appropriate fail-safe, backup, redundancy, and other measures to ensure its safe use. Oracle Corporation and its affiliates disclaim any liability for any damages caused by use of this software or hardware in dangerous applications.

Oracle and Java are registered trademarks of Oracle and/or its affiliates. Other names may be trademarks of their respective owners.

Intel and Intel Inside are trademarks or registered trademarks of Intel Corporation. All SPARC trademarks are used under license and are trademarks or registered trademarks of SPARC International, Inc. AMD, Epyc, and the AMD logo are trademarks or registered trademarks of Advanced Micro Devices. UNIX is a registered trademark of The Open Group.

This software or hardware and documentation may provide access to or information about content, products, and services from third parties. Oracle Corporation and its affiliates are not responsible for and expressly disclaim all warranties of any kind with respect to third-party content, products, and services unless otherwise set forth in an applicable agreement between you and Oracle. Oracle Corporation and its affiliates will not be responsible for any loss, costs, or damages incurred due to your access to or use of third-party content, products, or services, except as set forth in an applicable agreement between you and Oracle.

Contents

Preface

Audience	xvii
Documentation Accessibility	xvii
Related Documents	xviii
Conventions	xviii

1 Introduction to Oracle Database Appliance

About Oracle Database Appliance	1-1
Oracle Database Appliance Software Terminology	1-3
About the Browser User Interface	1-5

2 Preparing for Oracle Database Appliance Installation and Deployment

Registering Your Support Identifier on My Oracle Support	2-1
Planning Oracle Database Appliance Configuration Options	2-1
Selecting Database Deployment Options for Oracle Database Appliance	2-2
Selecting Database Shapes for Oracle Database Appliance	2-3
Calculating Required Cores	2-4
Selecting Operating System Groups and Users	2-4
Gathering System Requirement Information	2-6
List of Information You Need Before Deployment	2-7
Checklist for System Details	2-10
Checklist for Custom Network Address Configuration	2-11

3 Readyng Oracle Database Appliance for Deployment

About Interconnect Cabling	3-1
Attaching Supplied Cables for Oracle Database Appliance	3-2
Attaching Cables for Oracle Database Appliance X5-2	3-2
Attaching Cables for Oracle Database Appliance Models X4-2	3-3

Cabling Oracle Database Appliance to Connect to Fiber Public Networks (Optional)	3-5
Attaching a Storage Expansion Shelf to Oracle Database Appliance	3-6
About Attaching and Cabling Storage Shelves	3-7
Installing and Cabling a Storage Expansion Shelf	3-7
Attaching Peripheral Devices	3-10
Attaching Power Cords and Initializing Components	3-11
Powering On Oracle Database Appliance the First Time	3-11
Defining Your Public Network Interface Type	3-13
Configuring Oracle Integrated Lights Out Manager	3-14

4 Provisioning Oracle Database Appliance Bare Metal System

Plumbing the Network	4-1
Verifying Cabling and Network Connections	4-4
Downloading Oracle Database Appliance Software	4-6
Installing Oracle Database Appliance Software	4-7
Creating the Appliance	4-8

5 Oracle Database Appliance Postinstallation Tasks

Configuring CPU Core Count	5-1
Securing Oracle ILOM Service Processors	5-1
Changing Oracle Database Appliance Passwords	5-2

6 Patching Oracle Database Appliance

About Patching Oracle Database Appliance	6-1
About Patching Pre-Checks	6-3
Patching Oracle Database Appliance Bare Metal Systems Using the Command-Line	6-5
Patching Oracle Database Appliance Bare Metal Systems Using the Browser User Interface	6-9
Updating Oracle Database Appliance Repository with Database Clone Files For Bare Metal Systems	6-11
Patching Existing Database Homes on Bare Metal Systems Using the Browser User Interface	6-12
Applying Additional Patches and Updates on Bare Metal Systems	6-13
Enabling Kernel Updates	6-13
Applying Out-of-Cycle Database Patches	6-14
Cleaning Up the Patch Repository	6-17
About Upgrading to a Different Database Home	6-18

7 Re-imaging Oracle Database Appliance

Uninstalling Oracle Database Appliance Components	7-1
Restoring an Oracle Database Appliance Baremetal System	7-4
Performing Secure Erase of Data on Storage Disks	7-5

8 Managing Oracle Databases

About Administrative Groups and Users on Oracle Database Appliance	8-1
About Data Migration Options for Oracle Database Appliance	8-2
About Standard Edition High Availability for Oracle Database Appliance	8-3
About Transparent Database Encryption (TDE) in Oracle Database Appliance	8-4
Working with Databases	8-5
Viewing Databases	8-6
Creating a Database Using the Browser User Interface	8-7
Creating a Database Using ODA CLI Commands	8-10
Cloning a Database from Backup	8-11
Cloning an Oracle ACFS Database Using the Browser User Interface	8-13
Cloning an Oracle ACFS Database Using Command Line Interface	8-14
Modifying a Database	8-15
Moving a Database from One Oracle Home to Another	8-16
Upgrading a Database	8-17
Deleting a Database	8-17
Working with Database Homes	8-18
About Managing Multiple Oracle Homes on Oracle Database Appliance	8-18
Viewing Database Homes	8-19
Creating a Database Home	8-19
Deleting a Database Home	8-20
Migrating Databases	8-20
About Migrating Databases	8-20
Configuring a Static Listener	8-21
Migrating a Database	8-22
Registering a Database	8-24
About Managing Multiple Database Instances Using Instance Caging	8-25
Oracle EM Express and DB Console	8-26

9 Managing Storage

About Managing Storage	9-1
Preparing for Storage Expansion	9-2

10 Backup, Restore and Recover Databases

About Database Backup and Recovery Options	10-2
Creating a Mount Point for NFS Backup Location	10-9
Configuring Agent Proxy Settings for Object Store Access	10-10
Creating a Database Backup Policy	10-11
Updating a Database with a Backup Policy	10-12
Updating a Database Backup Policy	10-13
Backing Up a Database Using the Browser User Interface	10-13
Viewing Backup Reports	10-14
Recovering a Database Using the Browser User Interface	10-14
Deleting a Backup Using the Browser User Interface	10-14
Deleting a Backup Policy	10-15
Using the CLI to Backup, Restore, and Recover	10-15
Preparing for Database Backup to Disk	10-16
Preparing for Database Backup to NFS Location	10-17
Preparing for Database Backup to Oracle Cloud	10-18
Backing Up a Database with the CLI	10-19
Recovering a Database with the CLI	10-20
Restoring a Database with the CLI	10-22
Restoring Archivelog with the CLI	10-25
Deleting Backups with the CLI	10-25

11 Using Oracle Data Guard for Disaster Management and Recovery on Oracle Database Appliance

About Oracle Data Guard on Oracle Database Appliance	11-1
Configuring Oracle Data Guard on Oracle Database Appliance	11-2
Viewing Oracle Data Guard Status on Oracle Database Appliance	11-12
Performing Oracle Data Guard Operations	11-13
Creating an Oracle Data Guard Network	11-14
Migrating an Oracle Data Guard Database from One System to Another	11-15
Patching Oracle Data Guard Databases on Oracle Database Appliance	11-20
Upgrading Oracle Data Guard Databases on Oracle Database Appliance	11-21
Enabling Oracle Active Data Guard on Existing Configurations	11-22
Deconfiguring Oracle Data Guard on Oracle Database Appliance	11-23

12 Managing CPU Pools on Oracle Database Appliance Bare Metal and KVM Deployments

About CPU Pools	12-1
Creating a CPU Pool in a Bare Metal or KVM Deployment	12-3

Viewing CPU Pools in a Bare Metal or KVM Deployment	12-4
Modifying a CPU Pool in a Bare Metal or KVM Deployment	12-4
Deleting a CPU Pool in a Bare Metal or KVM Deployment	12-5
Viewing CPU Pool Audit Records in a Bare Metal or KVM Deployment	12-6
About Over-Subscribed CPU Pools	12-6

13 Managing an Oracle Database Appliance KVM Deployment

About Oracle Database Appliance KVM Deployment	13-2
About Oracle Database Appliance KVM Virtualization Architecture	13-3
About Virtual Machines and Oracle Database Appliance KVM Deployments	13-3
About KVM Database Systems on Oracle Database Appliance	13-6
Managing Database Systems in KVM Deployment	13-7
Creating a Database System in a KVM Deployment	13-8
Listing Database Systems in a KVM Deployment	13-12
Describing a Database System in a KVM Deployment	13-13
Starting a Database System in a KVM Deployment	13-13
Stopping a Database System in a KVM Deployment	13-14
Deleting a Database System in a KVM Deployment	13-15
Setting Up and Configuring a KVM Deployment for Applications	13-16
Managing VM Storage in KVM Deployment	13-16
Creating a VM Storage in a KVM Deployment	13-17
Viewing VM Storage in a KVM Deployment	13-18
Modifying a Virtual Storage in a KVM Deployment	13-18
Deleting a VM Storage in a KVM Deployment	13-19
Managing Virtual Networks in KVM Deployment	13-19
Creating a Virtual Network in a KVM Deployment	13-20
Viewing Virtual Networks in a KVM Deployment	13-21
Starting and Stopping Virtual Networks in a KVM Deployment	13-22
Modifying a Virtual Network in a KVM Deployment	13-22
Deleting a Virtual Network in a KVM Deployment	13-23
Managing Virtual Disks in KVM Deployment	13-23
Creating a Virtual Disk in a KVM Deployment	13-24
Viewing Virtual Disks in a KVM Deployment	13-25
Cloning a Virtual Disk in a KVM Deployment	13-25
Modifying a Virtual Disk in a KVM Deployment	13-26
Deleting a Virtual Disk in a KVM Deployment	13-27
Managing Virtual Machines in KVM Deployment	13-27
Creating a Virtual Machine in a KVM Deployment	13-28
Cloning a Virtual Machine in a KVM Deployment	13-30
Modifying a Virtual Machine in a KVM Deployment	13-31

Viewing Virtual Machines in a KVM Deployment	13-32
Starting and Stopping Virtual Machines in a KVM Deployment	13-32
Deleting a Virtual Machine in a KVM Deployment	13-33
Example JSON File to Create a Single-Node DB System	13-34
Example JSON File to Create a High-Availability DB System	13-36

14 Oracle Database Appliance Command-Line Interface

About Oracle Database Appliance Command-Line Interface	14-2
Managing ODACLI Privileges and Security with SUDO	14-5
odacli Network Commands	14-7
odacli configure-firstnet	14-8
odacli create-network	14-10
odacli delete-network	14-11
odacli delete-networkinterface	14-13
odacli describe-network	14-14
odacli describe-networkinterface	14-15
odacli list-networks	14-16
odacli list-networkinterfaces	14-17
odacli update-network	14-18
odacli Apply Patch and Update Commands	14-19
odacli cleanup-patchrepo	14-20
odacli create-prepatchreport	14-22
odacli delete-agentconfig-parameters	14-23
odacli delete-prepatchreport	14-24
odacli describe-component	14-25
odacli describe-latestpatch	14-29
odacli describe-prepatchreport	14-31
odacli list-agentconfig-parameters	14-34
odacli list-availablepatches	14-35
odacli list-prepatchreports	14-36
odacli update-agentconfig-parameters	14-37
odacli update-dbhome	14-39
odacli update-dcsadmin	14-39
odacli update-dcsagent	14-40
odacli update-dcscomponents	14-41
odacli update-registry	14-42
odacli update-repository	14-44
odacli update-server	14-45
odacli update-storage	14-46
odaadmcli orachk	14-47

odacli Appliance Commands	14-48
odacli set-credential	14-48
odacli create-appliance	14-49
odacli describe-system	14-50
odacli list-featuretracking	14-53
odacli Backup and Recovery Commands	14-55
odacli create-backup	14-57
odacli create-backupconfig	14-59
odacli create-objectstoreswift	14-60
odacli delete-backup	14-61
odacli delete-backupconfig	14-62
odacli describe-backupreport	14-63
odacli delete-objectstoreswift	14-64
odacli describe-schedule	14-65
odacli irestore-database	14-65
odacli list-backupconfigs	14-69
odacli list-backupreports	14-70
odacli list-objectstoreswifts	14-70
odacli list-schedules	14-71
odacli list-tdebackupreports	14-72
odacli recover-database	14-73
odacli restore-archivelog	14-75
odacli restore-tdewallet	14-75
odacli update-backupconfig	14-76
odacli update-objectstoreswift	14-78
odacli update-schedule	14-79
Oracle Data Guard odacli Commands	14-79
odacli configure-dataguard	14-80
odacli deconfigure-dataguard	14-85
odacli describe-dataguardstatus	14-86
odacli failover-dataguard	14-87
odacli list-dataguardstatus	14-88
odacli reinstate-dataguard	14-88
odacli switchover-dataguard	14-89
odacli CPU Core Commands	14-90
odacli list-cpucores	14-90
odacli describe-cpucore	14-91
update-cpucore	14-91
odacli CPU Pool Commands for Bare Metal and KVM	14-92
odacli create-cpupool	14-93
odacli list-cpupools	14-94

odacli describe-cpupool	14-94
odacli modify-cpupool	14-95
odacli delete-cpupool	14-95
odacli list-auditrecords	14-96
odacli describe-auditrecord	14-97
odacli Database Commands	14-98
odacli clone-database	14-98
odacli create-database	14-101
odacli delete-database	14-106
odacli describe-database	14-107
odacli list-databases	14-108
odacli modify-database	14-109
odacli move-database	14-113
odacli register-database	14-114
odacli upgrade-database	14-117
odacli DBHome Commands	14-119
odacli create-dbhome	14-119
odacli delete-dbhome	14-120
odacli describe-dbhome	14-121
odacli list-dbhomes	14-121
odacli Database Storage Commands	14-122
odacli create-dbstorage	14-123
odacli delete-dbstorage	14-124
odacli describe-dbstorage	14-125
odacli describe-dgstorage	14-126
odacli list-dbstorages	14-128
odacli list-dgstorages	14-129
odacli modify-dbstorage	14-130
odacli update-dgstorage	14-132
odacli Job Commands	14-133
odacli create-jobdata-retention-policy	14-133
odacli create-purge-jobdata-job	14-135
odacli delete-jobdata-retention-policy	14-139
odacli describe-job	14-140
odacli list-jobs	14-141
odacli list-jobdata-retention-policy	14-144
odacli list-purge-jobdata-job	14-145
odacli list-scheduled-executions	14-146
Log Commands	14-147
odaadmcli manage diagcollect	14-148
odacli create-auto-logclean-policy	14-149

odacli create-logcleanjob	14-150
odacli describe-logcleanjob	14-152
odacli list-auto-logclean-policy	14-153
odacli list-logcleanjobs	14-154
odacli list-logspaceusage	14-154
odacli Oracle Auto Service Request Commands	14-155
odacli configure-asr	14-156
odacli delete-asr	14-157
odacli describe-asr	14-158
odacli test-asr	14-159
odacli update-asr	14-160
odacli OS Commands	14-161
odacli list-osconfigurations	14-161
odacli update-osconfigurations	14-162
odaadmcli Hardware Monitoring Commands	14-163
odaadmcli show cooling	14-164
odaadmcli show env_hw	14-164
odaadmcli show fs	14-165
odaadmcli show memory	14-166
odaadmcli show network	14-166
odaadmcli show power	14-167
odaadmcli show processor	14-168
odaadmcli show server	14-169
Storage Commands	14-169
odaadmcli expand storage	14-170
odacli list-dgdisks	14-171
odacli validate-storagetopology	14-173
odaadmcli power disk	14-173
odaadmcli show controller	14-174
odaadmcli show disk	14-175
odaadmcli show diskgroup	14-176
odaadmcli show raidsyncstatus	14-177
odaadmcli show storage	14-178
odaadmcli stordiag	14-179

15 Oracle Database Appliance Command-Line Interface for KVM

About Command-Line Interface for Kernel-Based Virtual Machine (KVM)	15-1
About ODACLI Commands Supported on Oracle KVM Database System	15-3
odacli Database System Commands for KVM	15-3
odacli create-dbsystem	15-4

odacli list-dbsystems	15-5
odacli describe-dbsystem	15-6
odacli describe-dbsystem-image	15-12
odacli start-dbsystem	15-13
odacli stop-dbsystem	15-13
odacli delete-dbsystem	15-14
odacli VM Storage Commands for KVM	15-16
odacli create-vmstorage	15-16
odacli list-vmstorages	15-17
odacli describe-vmstorage	15-17
odacli modify-vmstorage	15-18
odacli delete-vmstorage	15-18
odacli Virtual Disk Commands for Oracle KVM	15-18
odacli create-vdisk	15-19
odacli list-vdisks	15-20
odacli describe-vdisk	15-20
odacli modify-vdisk	15-20
odacli clone-vdisk	15-21
odacli delete-vdisk	15-21
odacli CPU Pool Commands for Bare Metal and KVM	15-22
odacli create-cpupool	15-23
odacli list-cpupools	15-24
odacli describe-cpupool	15-24
odacli modify-cpupool	15-25
odacli delete-cpupool	15-25
odacli list-auditrecords	15-26
odacli describe-auditrecord	15-27
odacli VM Network Commands for KVM	15-28
odacli create-vnetwork	15-28
odacli list-vnetworks	15-29
odacli describe-vnetwork	15-29
odacli start-vnetwork	15-30
odacli stop-vnetwork	15-30
odacli modify-vnetwork	15-31
odacli delete-vnetwork	15-31
odacli Virtual Machine Commands for Oracle KVM	15-32
odacli create-vm	15-32
odacli list-vm	15-34
odacli describe-vm	15-34
odacli modify-vm	15-34
odacli start-vm	15-36

odacli stop-vm	15-36
odacli migrate-vm	15-37
odacli clone-vm	15-37
odacli delete-vm	15-38

16 Troubleshooting Oracle Database Appliance

Resolving Errors When Updating DCS Components During Patching	16-2
Viewing Component Information on the Appliance	16-7
Errors When Logging into the Browser User Interface	16-10
Errors when re-imaging Oracle Database Appliance	16-11
Using Oracle Autonomous Health Framework for Running Diagnostics	16-11
About Installing Oracle Autonomous Health Framework	16-12
Using the Oracle ORAchk Health Check Tool	16-13
Generating and Viewing Oracle ORAchk Health Check Tool Reports in the Browser User Interface	16-14
Generating and Viewing Database Security Assessment Reports in the Browser User Interface	16-14
Running Oracle Trace File Analyzer (TFA) Collector Commands	16-15
Sanitizing Sensitive Information in Diagnostic Collections	16-18
Sanitizing Sensitive Information in Oracle Trace File Analyzer Collections	16-19
Sanitizing Sensitive Information in Oracle ORAchk Output	16-20
Running the Disk Diagnostic Tool	16-21
Running the Oracle Database Appliance Hardware Monitoring Tool	16-22
Configuring a Trusted SSL Certificate for Oracle Database Appliance	16-23
Option 1: Creating a Key and Java Keystore and Importing a Trusted Certificate	16-24
Option 2: Packaging an Existing PEM-format Key and Certificates in a New Java Keystore	16-26
Option 3: Converting an Existing PKCS or PFX Keystore to a Java Keystore	16-26
Configuring the DCS Server to Use Custom Keystore	16-27
Configuring the DCS Agent for Custom Certificate	16-28
Disabling the Browser User Interface	16-28
Preparing Log Files for Oracle Support Services	16-29

A Oracle Database Appliance Software Configuration Defaults

Directory Paths for Oracle Database Appliance	A-1
Location of Log Files	A-2
Oracle Groups and User Configurations for Oracle Database Appliance	A-3

B Oracle Database Appliance Storage Defaults

Database Disk Group Sizes for Oracle Database Appliance	B-1
Usable Storage on Oracle Database Appliance X5-2	B-3
About Oracle Database Appliance Storage	B-4
Oracle ACFS Mount Points and Storage Space	B-5
Oracle ACFS Space Management	B-6

C Creating an Appliance Using JSON File

Loading and Saving Appliance Configurations	C-1
Readme for the Command <code>odacli create-appliance</code>	C-2
Example JSON Files to Create a Single Node Appliance with the CLI	C-2
Example JSON File to Create a Multi-Node Appliance with the CLI	C-7

D Database Templates for Oracle Database Appliance

Types of Database Templates for Oracle Database Appliance	D-1
---	-----

Index

List of Figures

2-1	Two Custom Users with Six Custom Groups	2-6
3-1	Interconnects and Cables for a Single Storage Shelf on Oracle Database Appliance X5-2	3-2
3-2	Interconnects and Cables for Single Storage Shelf on Oracle Database Appliance X4-2	3-4
3-3	Interconnects When Using Fiber Connections to the Public Network on Oracle Database Appliance Models X5-2	3-6
3-4	Cables for Storage Expansion Shelf on Oracle Database Appliance X5-2	3-9
3-5	Front of Oracle Database Appliance Models X3-2, X4-2, and X5-2: Power Panel	3-12
3-6	Front of Oracle Database Appliance Version 1: Power Panel	3-13

List of Tables

1-1	Software for Oracle Database Appliance	1-3
2-1	Checklist for System Configuration Information for Oracle Database Appliance	2-10
2-2	Default IP Address Requirements for Oracle Database Appliance	2-11
3-1	Description of Callouts for Cabling Oracle Database Appliance X5-2 With Single Storage Shelf	3-3
3-2	Description of Callouts for Cabling Oracle Database Appliance X4-2 With Single Storage Shelf	3-4
3-3	Description of Callouts for Cabling Oracle Database Appliance Storage Expansion Shelf	3-9
3-4	Peripheral Device Connections for Oracle Database Appliance	3-10
3-5	Description of Callouts for Powering On Oracle Database Appliance	3-12
7-1	Command Options for Cleanup Utility	7-2
8-1	Operating System Groups and Users on Oracle Database Appliance	8-2
11-1	Oracle Data Guard protection modes and transport modes	11-5
16-1	Command Options for tfactl Tool	16-15
A-1	Default Operating System Groups and Users Configuration for Oracle Database Appliance	A-3
B-1	Approximate Database Disk Group Sizes for Oracle Database Appliance X5-2 and X6-2-HA	B-1
B-2	Usable Storage on Oracle Database Appliance X5-2	B-3
B-3	Oracle ACFS Mount Points and Related Oracle ASM Disk Groups and Volume Information	B-5
D-1	Oracle Database Appliance Database Generic Template Name Conversions	D-3
D-2	Oracle Database Appliance OLTP Database Template Sizes	D-3
D-3	Oracle Database Appliance DSS Database Template Sizes	D-4
D-4	Oracle Database Appliance In-Memory Database Template Size	D-5
D-5	Oracle Database Appliance X5-2 Database Template Size Storage Performance	D-5
D-6	Oracle Database Appliance X4-2 Database Template Size Storage Performance	D-6
D-7	Oracle Database Appliance X3-2 Database Template Size Storage Performance	D-6
D-8	Oracle Database Appliance Version 1 Database Template Size Storage Performance	D-7

Preface

Oracle Database Appliance is an optimized, prebuilt database system that is easy to deploy, operate, and manage. By integrating hardware and software, Oracle Database Appliance eliminates the complexities of nonintegrated, manually assembled solutions. Oracle Database Appliance reduces the installation and software deployment times from weeks or months to just a few hours while preventing configuration and setup errors that often result in suboptimal, hard-to-manage database environments.

- [Audience](#)
- [Documentation Accessibility](#)
- [Related Documents](#)
- [Conventions](#)

Audience

This guide is intended for anyone who configures, maintains, or uses Oracle Database Appliance:

- System administrators
- Network administrators
- Database administrators
- Application administrators and users

This book does not include information about Oracle Database architecture, tools, management, or application development that is covered in the main body of Oracle Documentation, unless the information provided is specific to Oracle Database Appliance. Users of Oracle Database Appliance software are expected to have the same skills as users of any other Linux-based Oracle Database installations.

Documentation Accessibility

For information about Oracle's commitment to accessibility, visit the Oracle Accessibility Program website at <http://www.oracle.com/pls/topic/lookup?ctx=acc&id=docacc>.

Access to Oracle Support

Oracle customers that have purchased support have access to electronic support through My Oracle Support. For information, visit <http://www.oracle.com/pls/topic/lookup?ctx=acc&id=info> or visit <http://www.oracle.com/pls/topic/lookup?ctx=acc&id=trs> if you are hearing impaired.

Related Documents

For more information about Oracle Database Appliance, go to <http://www.oracle.com/goto/oda/docs> and click the appropriate release. The following documents are published in the Oracle Database Appliance online documentation library:

- *Oracle Database Appliance Release Notes*
- *Oracle Database Appliance Licensing Information User Manual*
- *Oracle Database Appliance Security Guide*
- *Oracle Database Appliance Accessibility Guide*
- *Oracle Database Appliance X8-2 Deployment and User's Guide*
- *Oracle Database Appliance X7-2 Deployment and User's Guide*
- *Oracle Database Appliance X6-2-HA Deployment and User's Guide*
- *Oracle Database Appliance X6-2S/M/L Deployment and User's Guide*
- *Oracle Database Appliance X5-2 Deployment and User's Guide*
- Oracle Database Appliance Setup Posters and Booklets (a full-size printed copy ships with Oracle Database Appliance)
- *Oracle Database Appliance Owner's Guide*
- *Oracle Database Appliance Service Manual*
- *Oracle Database Appliance Series Safety and Compliance Guide*

For more information about using Oracle Database, go to <http://docs.oracle.com/en/database/> and select the database release from the menu. See the following documents in the Oracle Database online documentation library:

- *Oracle Database Security Guide*
- *Oracle Database Administrator's Guide*
- *Oracle Database SQL Language Quick Reference*
- *Oracle Database Backup and Recovery User's Guide*
- *Oracle Database Backup and Recovery Reference*
- *Oracle Database Utilities*
- *Oracle Automatic Storage Management Administrator's Guide*

For more information about Oracle Integrated Lights Out Manager 3.2, see https://docs.oracle.com/cd/E37444_01/.

For more details about other Oracle products that are mentioned in Oracle Database Appliance documentation, see the Oracle Documentation home page at <http://docs.oracle.com>.

Conventions

The following text conventions are used in this document:

Convention	Meaning
boldface	Boldface type indicates graphical user interface elements associated with an action or terms defined in the text.
<i>italic</i>	Italic type indicates book titles, emphasis, or placeholder variables for which you supply particular values.
monospace	Monospace type indicates commands within a paragraph, URLs, code in examples, text that appears on the screen, or text that you enter.
# prompt	The pound (#) prompt indicates a command that is run as the root user.

1

Introduction to Oracle Database Appliance

Oracle Database Appliance saves time and money by simplifying deployment, maintenance, and support of database solutions for organizations of every size. Oracle Database Appliance hardware models are optimized to run Oracle Database Standard Edition and Enterprise Edition.

- [About Oracle Database Appliance](#)
Understand Oracle Database Appliance hardware models, deployment plans, and database options.
- [Oracle Database Appliance Software Terminology](#)
Understand the software patches available for Oracle Database Appliance.
- [About the Browser User Interface](#)
Use the Oracle Appliance Manager Browser User Interface to deploy and manage the appliance, databases, networks, and jobs.

About Oracle Database Appliance

Understand Oracle Database Appliance hardware models, deployment plans, and database options.

About Oracle Database Appliance Hardware Models

Choose the Oracle Database Appliance hardware model that suits your business needs.

Oracle Database Appliance Hardware Model	Deployment Use Case
Oracle Database Appliance X8-2S, X8-2M, X8-2-HA	<ul style="list-style-type: none">• Oracle Database Appliance X8-2S is a small configuration designed for smaller or entry-level deployments.• Oracle Database Appliance X8-2M is a medium-sized configuration designed for performance.• Oracle Database Appliance X8-2-HA is a large configuration designed for larger databases and high-availability.
Oracle Database Appliance X7-2S, X7-2M, X7-2-HA	<ul style="list-style-type: none">• Oracle Database Appliance X7-2S is a small configuration designed for smaller or entry-level deployments.• Oracle Database Appliance X7-2M is a medium-sized configuration designed for performance.• Oracle Database Appliance X7-2-HA is a large configuration designed for larger databases and high-availability.

Oracle Database Appliance Hardware Model	Deployment Use Case
Oracle Database Appliance X6-2S, X6-2M, X6-2L	<ul style="list-style-type: none"> Oracle Database Appliance X6-2S is a small configuration designed for smaller or entry-level deployments. Oracle Database Appliance X6-2M is a medium-sized configuration designed for performance. Oracle Database Appliance X6-2L is a large configuration designed for larger databases.
Oracle Database Appliance X6-2-HA	Highly-available two-node Oracle RAC clusters that can support both Oracle RAC and single-instance databases.
Oracle Database Appliance X5-2	Highly-available two-node Oracle RAC clusters that can support both Oracle RAC and single-instance databases.

You cannot expand or reconfigure Oracle Database Appliance to a different configuration. For example, you cannot expand Oracle Database Appliance X7-S to Oracle Database Appliance X7-2M. For Oracle Database Appliance hardware configuration details, see the *Oracle Database Appliance Owner's Guide*.

About Oracle Database Appliance Deployment Plans

Oracle Database Appliance X8-2S and X8-2M are single node systems that you deploy as a bare metal platform.

Oracle Database Appliance X8-2-HA is a two-node system with the option to deploy as a bare metal platform or a virtualized platform.

Oracle Database Appliance X7-2S and X7-2M are single node systems that you deploy as a bare metal platform.

Oracle Database Appliance X7-2-HA is a two-node system with the option to deploy as a bare metal platform or a virtualized platform.

Oracle Database Appliance X6-2S, X6-2M, X6-2L are single node systems that you deploy as a bare metal platform.

Oracle Database Appliance X6-2-HA is a two-node system with the option to deploy as a bare metal platform or a virtualized platform.

Oracle Database Appliance X5-2 is a two-node system with the option to deploy as a bare metal platform or a virtualized platform.

About Database Deployment Options for Oracle Database Appliance

The following Oracle Database editions are available:

Database Edition	Supported Releases
Oracle Database Enterprise Edition	Oracle Database release 19c, 18c, 12.2.0.1, 12.1.0.2, and 11.2.0.4
Oracle Database Standard Edition 2	Oracle Database release 19c, 18c, 12.2.0.1, 12.1.0.2, and 11.2.0.4

Database Edition	Supported Releases
Oracle Database Standard Edition 1	Oracle Database release 11.2.0.4

 **Note:**

It is important to understand your Oracle Database licensing before you create databases. You cannot provision Oracle Database Enterprise Edition and Standard Edition databases in the same bare metal platform, or the same ODA_BASE virtualized deployment, subject to Oracle Database licensing requirements. Review the *Oracle Database Licensing Information User Manual* for the Oracle Database release to review supported options and products.

Oracle Database Appliance Software Terminology

Understand the software patches available for Oracle Database Appliance.

The table describes the Oracle Database Appliance patches that are available for download and the purpose of the patch.

 **Note:**

Some hardware models may not use the patches listed in the table.

Table 1-1 Software for Oracle Database Appliance

Patch	Description
Oracle Database Appliance patch bundle (quarterly patch release)	Use the patch bundle to update to the latest release after Oracle Database Appliance is deployed. The patch updates the Oracle Database Appliance server, storage, and database components.
Oracle Database Appliance GI/RDBMS Clone	Use to perform an initial deployment of Oracle Database Appliance. The bundle contains the latest Grid Infrastructure and RDBMS components, Oracle Database Appliance Manager software, Oracle Linux and hardware drivers for deployment on an Oracle Database Appliance that is shipped from factory state. If you reimage Oracle Database Appliance with the Bare Metal ISO Image, download the GI/RDBMS Clone patch to deploy Oracle Database Appliance.
RDBMS Clone	Use the RDBMS Software Clone files to get the latest RDBMS clone binaries for Oracle Database releases 19c, 18c, 12.2.0.1, 12.1.0.2, and 11.2.0.4. The RDBMS clone files are needed to create Oracle databases and database homes.
Bare Metal ISO Image	Use to reimage the appliance and reset the system back to the factory configuration.

Table 1-1 (Cont.) Software for Oracle Database Appliance

Patch	Description
VM ISO Image (DOM0) (Virtualized Platform ISO Image)	<p>Use to re-image Oracle Database Appliance before deploying the ODA_Base Template and virtualized platform. The Oracle Database Appliance virtualized operating system image contains the following:</p> <ul style="list-style-type: none"> • Oracle Database Appliance Manager oakcli command-line interface • Oracle Database Appliance Manager Configurator • Oracle Linux • Hardware drivers <p>Required for Virtualized Platform deployments on multi-node high availability (HA) systems.</p>
ODA_BASE Template (Virtualization Template)	<p>Use to create the ODA_Base virtual machine for a virtualized database appliance. The template contains the following:</p> <ul style="list-style-type: none"> • Oracle Virtual Machine template • Oracle Database clone binaries • Oracle Database templates, customized for Oracle Database Appliance deployments • Oracle Grid Infrastructure clone binaries <p>Required for Virtualized Platform deployments on multi-node HA systems.</p>

 **Note:**

See the *Oracle Database Appliance Release Notes* for the patch numbers and download locations and the component versions available in the patch bundle.

 **Note:**

Starting with Oracle Database 18c, Oracle provides quarterly updates in the form of Release Updates (Updates) and Release Update Revisions (Revisions). Oracle no longer releases patch sets. For more information, see My Oracle Support Note 2285040.1.

Oracle Database releases are of type `version` and `version_full` releases. The `version` release is designated in the form `major release version.0.0.0.0`. The major release version is based on the last two digits of the year in which an Oracle Database version is released for the first time. The `version_full` release is an update of a `version` release and is designated based on the major release version, the quarterly release update version (Update), and the quarterly release update revision version (Revision).

Prior to Oracle Database release 18c, changing the first or second digit in the release number was an upgrade, and changing the fourth digit indicated an update. With 18c and later releases, changing the first digit is an upgrade, and changing the second indicates an update.

About the Browser User Interface

Use the Oracle Appliance Manager Browser User Interface to deploy and manage the appliance, databases, networks, and jobs.

The Browser User Interface provides a user-friendly interface to quickly view and perform many of the tasks needed to deploy, patch, and manage your bare metal system. The *Oracle Database Appliance Deployment and User's Guide* for your hardware model describes how to use the Browser User Interface to perform many of the tasks related to deployment, patching, and management of your appliance.

Use the links in the side navigation to view and manage the following:

- **Appliance**
 - Appliance information
 - System information
 - Disk group information including storage utilization such as free and used space
 - Information about all databases that use a storage disk group
 - All the patches and hardware and software components installed on the appliance
 - List of RPMs and RPM Drift information
- **Network**
 - View network details
 - Create, update, and delete networks
 - View interface details
- **Oracle ASR**
 - View Oracle Auto Service Request (Oracle ASR) configuration details
 - Configure, update, test, and delete Oracle ASR
- **Patch Manager**
 - Update the patch repository with Oracle Database Appliance patches
 - View component details of the patch and versions that are installed on the appliance
 - View component details of the patch and versions that are available, but not yet installed, on the appliance
 - Run patch prechecks before applying the patch
 - Update the server and storage components

Use the links in the top navigation to view and manage the following:

- **Database**
 - Create a database
 - View database details
 - Apply a backup policy for the database

- Create a manual backup
- Recover a database from a backup
- View and update the database backup schedule and update the archive log backup schedule for the database
- Modify associated networks, database shape and class, and the associated backup policy for a database
- Create, update, and delete backup policies
- Create, update, and delete database homes
- Create and delete database backup
- Clone a database from a database backup or an Oracle ACFS database snapshot
- Patch database homes
- Move databases from one Oracle home to another
- **Object Store**
 - Create Object Store Credentials for backup and recovery
 - View the details for Object Store Credentials, including the endpoint URL, user name, and tenant
 - Update and delete Object Store Credentials
- **Monitoring**
 - View the status of hardware, storage, memory, cooling, networking, and power
 - View monitoring information for each node, in the case of High-Availability deployments
 - View system health status and drilldown to details of incidents
 - Click the hardware image to view details
- **Activity**
 - View a list of jobs, details, and status
 - Click a job description to view job details

Update ILOM and User Settings

Expand **About** in the upper right corner of the Browser User Interface to perform the following tasks:

- Click **About** to view the Oracle Database Appliance release that is installed on the appliance.
- Click **Update ILOM Setting** to change the root password. To enable first-time login and access to Oracle ILOM, a default Administrator (root) account and its password are provided with the system.
- Click **Update User Settings** to change the `oda-admin` password.
- Click **Sign Out** to sign out of the Browser User Interface. If you do not sign out, the system automatically signs you out after a period of inactivity. A warning will appear 2 minutes before the session expires.

You can access the Oracle Database Appliance documentation set from the Browser User Interface. For the latest updates to the documentation for a release, see the online Oracle Database Appliance documentation library at <https://docs.oracle.com/en/engineered-systems/oracle-database-appliance/index.html>.

2

Preparing for Oracle Database Appliance Installation and Deployment

Complete these setup tasks before Oracle Database Appliance is delivered.

Tasks:

- [Registering Your Support Identifier on My Oracle Support](#)
Add your hardware Support Identifier (SI) to your My Oracle Support account profile.
- [Planning Oracle Database Appliance Configuration Options](#)
Use these topics to help you to make decisions about your Oracle Database Appliance configuration.
- [Gathering System Requirement Information](#)
Use these checklists to collect information before deploying Oracle Database Appliance.

Registering Your Support Identifier on My Oracle Support

Add your hardware Support Identifier (SI) to your My Oracle Support account profile.

Your hardware SI is supplied when you purchase Oracle Database Appliance. If you acquire new software licenses, then you must also register your new software SIs. The SI registration process can take up to 24 hours to complete.

 **Note:**

You cannot obtain support or software from Oracle without registered SIs.

Planning Oracle Database Appliance Configuration Options

Use these topics to help you to make decisions about your Oracle Database Appliance configuration.

These topics help you to select the correct Oracle Database Appliance and plan for deployment. Record your decisions and the information that you require before you proceed to complete system configuration checklists.

▲ Caution:

Do not use Oracle Database Configuration Assistant (DBCA) to create databases on Oracle Database Appliance. Only use Oracle Appliance Manager for database configuration. Deploying Oracle Database instances using Oracle Appliance Manager ensures that these databases are properly configured, optimized, and supported on Oracle Database Appliance.

Topics:

- [Selecting Database Deployment Options for Oracle Database Appliance](#)
If you plan to create an initial database during deployment, then use these lists to select an Oracle Database deployment option, and prepare for the deployment.
- [Selecting Database Shapes for Oracle Database Appliance](#)
Oracle Database Appliance software includes preconfigured templates, known as shapes, that incorporate Oracle best practices with optimization for different classes of databases.
- [Calculating Required Cores](#)
After you select templates for your planned Oracle Database, identify your workload type, and determine the total number of CPUs that you require to support the templates.
- [Selecting Operating System Groups and Users](#)
Determine how you want to configure your operating system groups and users and whether or not you want to allow operating system role separation.

Selecting Database Deployment Options for Oracle Database Appliance

If you plan to create an initial database during deployment, then use these lists to select an Oracle Database deployment option, and prepare for the deployment.

Oracle Appliance Manager installs Oracle Database software on mirrored disks that are internal to Oracle Database Appliance. During the initial deployment, you can either create a database or you can defer database creation to a later time.

Options:

- **Enterprise Edition:** Oracle Database 18c Enterprise Edition (no automated failover), with the following characteristics:
 - Single-instance Oracle Database Enterprise Edition home
 - Oracle Database software installation on both nodes
- **Oracle Real Application Clusters (Oracle RAC) One Node:** Oracle RAC One Node 18c, with the following characteristics:
 - Oracle RAC One Node has a designated Oracle Database Appliance home node
 - Oracle RAC One Node software is installed on both servers
 - Automated failover is configured

- Enterprise Edition license is required
- Oracle RAC One Node license on each server is required
Exception: If you designate one server as a backup server, then you can use that server without a license, in accordance with the 10-day rule.
- **Oracle RAC:** Oracle Real Application Clusters 18c, with the following characteristics:
 - Oracle RAC home
 - Oracle RAC software is installed on both servers
 - Enterprise Edition license is required
 - Oracle RAC license on each server is required (not eligible for the 10-day rule)

 **Note:**

For information about the 10-day rule, see the *Oracle Software Investment Guide* at <https://www.oracle.com/corporate/pricing/>.

Selecting Database Shapes for Oracle Database Appliance

Oracle Database Appliance software includes preconfigured templates, known as shapes, that incorporate Oracle best practices with optimization for different classes of databases.

Because of differences in CPU counts, memory size, and other resources available with different Oracle Database Appliance models, some shapes are not supported on all models.

Each Oracle Database shape has different workload profile and performance characteristics:

- Memory requirements, which are calculated from the System Global Area (SGA), and Program Global Area (PGA) sizes
- Processing requirements, which are calculated from the number of processes
- Logging requirements, which are based on log buffer size, and online redo log size

Oracle Database Appliance shapes are tuned for the size of each database instance workload and are designed to run on a specific number of cores.

 **Note:**

Oracle strongly recommends that you use the Oracle Database Appliance shapes. These shapes implement best practices, and are configured specifically for Oracle Database Appliance.

Calculating Required Cores

After you select templates for your planned Oracle Database, identify your workload type, and determine the total number of CPUs that you require to support the templates.

Oracle Database Appliance templates are configured and tuned for specific types of Oracle Database workloads:

- Generic templates
- Online analytic transaction templates (OLTP)
- Decision support services templates (DSS)
- In-Memory database templates

These templates are designed to run on a specific number of cores. Caging ensures that each database workload is restricted to the set of cores allocated by the template, enabling multiple databases to run concurrently with no performance degradation, up to the capacity of Oracle Database Appliance. You can select database template sizes larger than your current needs to provide for planned growth, which you accommodate later by adjusting System Global Area (SGA) and Program Global Area (PGA) sizes, as well as the number of cores.

Selecting Operating System Groups and Users

Determine how you want to configure your operating system groups and users and whether or not you want to allow operating system role separation.

About Operating System Groups and Users

Role separation enables you to configure groups and users to provide separate groups for operating system authentication.

Without role separation, a single user owns all of the Oracle installations. All of the databases are installed under a single user. Role separation enables you to have separate users for Oracle and Oracle Clusterware. You can install multiple databases without sharing operating system authentication for system privileges. In addition, each Oracle software installation is owned by a separate installation owner, to provide operating system user authentication for modifications to Oracle Database binaries.

Note:

Any Oracle software owner can start and stop all databases and shared Oracle Grid Infrastructure resources, such as Oracle Automatic Storage Management (Oracle ASM) or Virtual IP (VIP). The job role separation configuration enables database security, it does not restrict user roles in starting and stopping various Oracle Clusterware resources.

With Oracle Grid Infrastructure role separation, separate operating system groups provide operating system authentication for Oracle ASM system privileges for storage tier administration. This operating system authentication is separated from Oracle Database operating system authentication. In addition, the Oracle Grid Infrastructure

installation owner provides operating system user authentication for modifications to Oracle Grid Infrastructure binaries.

You can configure the appliance with one of four combinations of operating system users, groups, and roles. The default users are the Oracle Database installation owner (`oracle`) and Oracle Grid Infrastructure installation owner (`grid`). The default groups are `oinstall`, `dbaoper`, `dba`, `asmadmin`, `asmoper`, and `asmdba`.

Default Configuration: Two Users with Six Groups

The default configuration is a combination of two operating system roles for users with six groups.

To configure two users, `oracle` user with the Oracle User (`oracleUser`) role and the `grid` user with the `gridUser` role, allow operating system role separation.

To configure six groups, `oinstall`, `dbaoper`, `dba`, `asmadmin`, `asmoper`, and `asmdba`, do not select the option to customize users and groups.

 **Note:**

When you select the default configuration in the Web Console, the users and groups do not appear in the interface.

Two Custom Users with Six Custom Groups

You can customize the configuration to create two custom users and six custom groups.

To configure two users, allow operating system role separation. The users are populated with the default values, `oracle` and `grid`, which you can edit.

To configure six groups, select the option to customize users and groups. The groups are populated with the default values, which you can edit. The default groups are `oinstall`, `dbaoper`, `dba`, `asmadmin`, `asmoper`, and `asmdba`.

The figure shows an example of a custom configuration with the default values populated.

Figure 2-1 Two Custom Users with Six Custom Groups

User & Group Selection

Customize Users & Groups Yes No

Allow OS Role Separation Yes No

Field Name	Value
GI User *	grid
DB User *	oracle
Install Group *	oinstall
DBA Oper Group *	dbaoper
DBA Group *	dba
ASM Admin Group *	asmadmin
ASM Oper Group *	asmoper
ASM DBA Group *	asmdba
GI UserID *	1000
DB UserID *	1001
Install GroupID *	1001
DBA Oper GroupID *	1002
DBA GroupID *	1003
ASM Admin GroupID *	1004
ASM Oper GroupID *	1005
ASM DBA GroupID *	1006

Single Custom User with Six Custom Groups

You can customize the configuration to create a single operating system database user and with six custom groups. The database user can deploy both the grid infrastructure and RDBMS (relational database management system) stacks. You can edit the user name and user ID and you can customize the group names and IDs. Use this option when you deploy SAP.

To configure a single `oracle` database user with the Oracle User (`oracleUser`) role, do not allow OS role separation.

To configure six groups, select the option to customize users and groups. The following default groups are populated: `oinstall`, `dbaoper`, `dba`, `asmadmin`, `asmoper`, and `asmdba`. You can customize the groups.

Single User with Two Groups

To configure a single `oracle` user with the Oracle User (`oracleUser`) role, do not allow OS role separation.

To configure two groups, `oinstall` and `dba`, do not select the option to customize users and groups.

Gathering System Requirement Information

Use these checklists to collect information before deploying Oracle Database Appliance.

- [List of Information You Need Before Deployment](#)
Collect storage and network information required to prepare for deploying Oracle Database Appliance.

- [Checklist for System Details](#)
Use the checklist to gather system information that you need to obtain for Oracle Database Appliance. Record the values for your system.
- [Checklist for Custom Network Address Configuration](#)
Use the checklist to identify the IP addresses required for Oracle Database Appliance.

List of Information You Need Before Deployment

Collect storage and network information required to prepare for deploying Oracle Database Appliance.

Review your security requirements for `root` passwords, determine your storage requirements and network administration requirements, and complete any required configuration before your Oracle Database Appliance hardware is delivered.

Security Requirements

- What root password should you use for Oracle Database Appliance? Root passwords should comply with your system security requirements.
- Secure operating systems are an important basis for general system security. Ensure that your operating system deployment is in compliance with common security practices.

Storage Administration Requirements

Storage administration is integrated into Oracle Database Appliance. No additional storage configuration is required.

Oracle Database Appliance includes integrated storage for operational files (operating system, Oracle Grid Infrastructure home, Oracle Database homes, tools), user data (database files), and log files (database redo logs). Operational files are stored on mirrored internal system disks in each server.

Data and database redo log files are stored on shared disks:

- On Oracle Database Appliance X5-2, data files are stored in the storage shelf and the optional storage expansion shelf. Database redo log files are stored on solid-state drives (SSDs) in the storage shelf, and on the optional storage expansion shelf.

Oracle Database Appliance X5-2 contains four 400 GB SSDs, which are configured as an ASM disk group, using ACFS for an additional database cache. Also, on Oracle Database Appliance X5-2, four 200 GB SSDs are used for attribute caching, in addition to the database redo logs.

Note:

Oracle Database Appliance X5-2 ships with 4 TB shared disks. Disk hardware capacity is measured using the formula that 1 KB equals 1,000 bytes; software storage requirements are based on 1 KB equals 1,024 bytes. This difference of 24 bytes means that a disk that has a rated capacity of 4 TB actually has about 3.725 TB of available space for software storage.

Network Administration Requirements

Ensure that the names and addresses that you provide for network configuration are configured in your Domain Name System (DNS) servers. With Patch Set 1 and later, the addresses that you provide are configured in the `/etc/hosts` file to provide IP name and address resolution, even if a DNS server is not available.

If you are deploying Oracle Database Appliance X5-2 or X4-2, then you have the option to connect either to a copper, or to a fiber public network. To connect to a fiber network on Oracle Database Appliance X5-2, you must also replace the InfiniBand cards with 10 GbE SFP+ fiber cards. Ensure that your network planning is based on the correct type of public network.

Oracle recommends that you resolve addresses using a DNS server, so that you can use Single Client Access Names (SCANs). Having a single name to access the cluster enables the client to use the EZConnect client and the simple JDBC thin URL to access any Oracle Database running in the cluster, independent of the active servers in the cluster. The SCAN provides load-balancing and failover for client connections to these databases. The SCAN works as a cluster alias for Oracle Databases in the cluster.

If you deploy without using a DNS server, then you can add a DNS server later, and add SCANs. If you add SCANs, then you must specify additional VIP addresses for those SCANs.

A correctly configured Oracle Database Appliance requires at least six public addresses on the same subnet for the nodes:

- A public IP name and address for each node
- A virtual IP name and address for each node
- Two addresses that resolve to the SCAN for the cluster

All names must conform to the RFC 952 standard, which permits alphanumeric characters and hyphens ("-"), but does not allow underscores ("_").

Provide an IP address for the public interface for each node. This interface is `bond0`, or `Eth1` on Oracle Database Appliance Virtualized Platform, (a bond of `Eth2` and `Eth3`), which is used for the host IP address for the node.

If you select a Custom installation, then provide names and addresses for the following optional interfaces that you need:

- `bond1` (Ethernet bond): This applies to all Oracle Database Appliance platforms.
- `bond2` (Ethernet bond): This applies only to Oracle Database Appliance Version 1.
- `xbond0` (for high capacity transfers, such as backups): This applies only to Oracle Database Appliance Version 1.

Use `bond1` and `bond2` for management, backup, disaster recovery, or other options where you require a network interface. Be prepared to provide a netmask and a gateway for each interface, as both are required when you configure network connections for Oracle Database Appliance.

Also determine answers to the following questions:

- Do you have a Network Time Protocol (NTP) service configured for each server, so that the local system time for each server is synchronized?

If you have NTP servers, and you want to synchronize time between Oracle Database Appliance nodes using NTP, then be prepared to provide the addresses for the servers. If you do not provide addresses for NTP servers, then Oracle Grid Infrastructure software configures time synchronization between nodes using Cluster Time Synchronization Service (CTSS).

- Do you want to plug in the public IP address cables to redundant switches, so that you can avoid a single point of failure for Oracle Database Appliance? Oracle recommends that you use redundant switches for High Availability.

IP Address Questions to Ask Your Network Administrator

Confirm with your network administrator that the IP addresses that you configure for Oracle Database Appliance meet these three criteria:

1. They are static IP addresses.
2. They are on the same subnet as all other IP addresses, virtual IP (VIP) addresses (used for Oracle Real Application Clusters communication), and SCAN addresses.
3. They include the following:
 - One public IP address configured on the DNS server for each node and resolvable to that node before installation.
 - A VIP address for each node configured on the DNS server that is not currently in use.
 - SCANS for Oracle Database Appliance with the following characteristics:
 - Configured on the DNS server before installation, so that the two IP addresses are associated with the name provided as the SCAN, and both addresses are returned in random order to the requester by the DNS server
 - Configured on the DNS server before installation to resolve to addresses that are not currently in use
 - Have names that do not begin with a numeral

Caution:

Do not change the IP addresses and subnet for the private network.

Note:

Configuring SCANS in a Network Information Service (NIS) is not supported.

Additional Information

See *Oracle Database Appliance Owner's Guide* for information about replacing the InfiniBand cards with 10 GbE SFP+ fiber cards. For a comprehensive introduction to SCANS, see "Oracle Single Client Access Name (SCAN)", a technical paper on Oracle Technology, and *Oracle Grid Infrastructure Installation Guide for Linux*.

Related Topics

- [Oracle Grid Infrastructure Installation Guide for Linux](#)

Checklist for System Details

Use the checklist to gather system information that you need to obtain for Oracle Database Appliance. Record the values for your system.

Table 2-1 Checklist for System Configuration Information for Oracle Database Appliance

System Information	Description
Oracle Database Appliance System Name	<p>Provide the name for the cluster running on Oracle Database Appliance. This name is also used as the default root word for Oracle Database Appliance network addresses. The name must be unique across your enterprise, must be at least one character long and no more than 13 characters in length, must be alpha-numeric, cannot begin with a numeral, and may contain hyphens (-). Underscore characters (_) are not allowed.</p> <p>The name you choose will become the default first part of the names for the following items. The default (generated names) can be changed.</p> <ul style="list-style-type: none"> • Oracle ILOM host names for Nodes 1 and 2 (<i>systemname1-ilom</i> and <i>systemname2-ilom</i> respectively) • SCAN host name (<i>systemname-scan</i>) • Node 0 and Node 1 Public IP addresses (<i>systemname1</i> and <i>systemname2</i> respectively) • Node 0 and Node 1 Virtual IP addresses (<i>systemname1-vip</i> and <i>systemname2-vip</i> respectively) <p>The name should comply with the host name specifications described in the RFC 952 standard.</p>
Type of Configuration	<p>Typical, which has the most default values.</p> <p>Custom (recommended by Oracle), which allows you to override default values for any or all of the following:</p> <ul style="list-style-type: none"> • Database block size, language, territory, backup file location, or disk redundancy level for the DATA and RECO disk groups • Oracle Integrated Lights Out Manager (Oracle ILOM) server • Oracle Auto Service Request (Oracle ASR) configuration • Oracle Cloud File System mount point and file system size • Network Time Protocol (NTP) service server
Mode	Bare metal or virtualized platform
Region	Select the region where you plan to operate the Oracle Database Appliance system.
Timezone	Select the time zone where you plan to operate the Oracle Database Appliance system.
Initial Database Details (if you want to create one during deployment)	<ul style="list-style-type: none"> • Database name • Normal or container database • Class (database template) • Database language • Database deployment (Oracle Enterprise Edition single instance, Oracle RAC One Node, or Oracle RAC) • (Container databases only) Data file size, in gigabytes (GB)
Root password	You are prompted to provide a root password for the system. Ensure that the root password you provide is in compliance with common security practices.

 **Note:**

Oracle recommends that you use all lowercase characters for the host name. The names are generated from the system name. For example, if you use `mysystem` as the name of your system, then the derived host names are `mysystem0` and `mysystem1`; the derived host virtual IP names are `mysystem0-vip` and `mysystem1-vip`; and the ILOM names are `mysystem0-ilom` and `mysystem1-ilom`.

Checklist for Custom Network Address Configuration

Use the checklist to identify the IP addresses required for Oracle Database Appliance.

 **Note:**

Oracle does not recommend changing the default Host Private Address. You cannot change the private network after deploying the appliance.

Table 2-2 Default IP Address Requirements for Oracle Database Appliance

Type of IP	IP Address Default Values	Your Values As Applicable
Client Access Network	No default	No default
Additional Network	No default	No default
Oracle Integrated Lights Out Manager (ILOM)	No default	No default
Host Private Addresses	InfiniBand has bonded interface <code>ibbond0</code> . The system configures <code>icbond0</code> on non-InfiniBand High-Availability systems. The subnet <code>192.168.16.0/24</code> is configured.	Not applicable: the private addresses are defined before deployment and should not be changed

3

Readying Oracle Database Appliance for Deployment

Complete these tasks to prepare to deploy Oracle Database Appliance.

Topics:

- [About Interconnect Cabling](#)
Interconnect is reserved for Oracle Grid Infrastructure (GI) and Oracle Relational Database Management System (RDBMS).
- [Attaching Supplied Cables for Oracle Database Appliance](#)
If you are using Oracle Database Appliance with a single storage shelf, attach the interconnect cables.
- [Attaching a Storage Expansion Shelf to Oracle Database Appliance](#)
Review these topics to install and cable a storage expansion shelf for Oracle Database Appliance.
- [Attaching Peripheral Devices](#)
Complete this task if you have direct access to Oracle Database Appliance and you intend to use a locally connected monitor, keyboard and mouse.
- [Attaching Power Cords and Initializing Components](#)
Attach power cords for Oracle Database Appliance.
- [Powering On Oracle Database Appliance the First Time](#)
Use this procedure to power on Oracle Database Appliance.
- [Defining Your Public Network Interface Type](#)
Understand how you can define the public network interface type before deploying the appliance.
- [Configuring Oracle Integrated Lights Out Manager](#)
Configure Oracle Integrated Lights Out Manager (Oracle ILOM) to manage Oracle Database Appliance independent of the operating system.

About Interconnect Cabling

Interconnect is reserved for Oracle Grid Infrastructure (GI) and Oracle Relational Database Management System (RDBMS).

Oracle GI includes Oracle Clusterware, Oracle Automatic Storage Management (Oracle ASM), and Oracle Restart. Even if you do not use Oracle Real Application Clusters (RAC), Oracle Database Appliance uses the interconnect for RAC ASM and Oracle GI.

 **Note:**

Do not use interconnect for other applications.

When you power on Oracle Database Appliance for the first time, the system automatically defines your public network interface based on the interconnect. If you use the InfiniBand cards, then the InfiniBand network is used for the interconnect. If you ordered the configuration that contains the 10GbE SFP+ (fiber) cards instead of InfiniBand cards, then the onboard 10GBase-T (Copper) ports are used for the interconnect.

Attaching Supplied Cables for Oracle Database Appliance

If you are using Oracle Database Appliance with a single storage shelf, attach the interconnect cables.

Topics:

- [Attaching Cables for Oracle Database Appliance X5-2](#)
Use the diagram in this topic to understand how to attach cable connections between ports on Oracle Database Appliance model X5-2 with a single storage shelf:
- [Attaching Cables for Oracle Database Appliance Models X4-2](#)
Use the diagram in this topic to understand how to attach cable connections between ports on Oracle Database Appliance model X4-2.
- [Cabling Oracle Database Appliance to Connect to Fiber Public Networks \(Optional\)](#)
You can configure X5-2 appliances to use fiber connections for the public network.

Attaching Cables for Oracle Database Appliance X5-2

Use the diagram in this topic to understand how to attach cable connections between ports on Oracle Database Appliance model X5-2 with a single storage shelf:

Figure 3-1 Interconnects and Cables for a Single Storage Shelf on Oracle Database Appliance X5-2

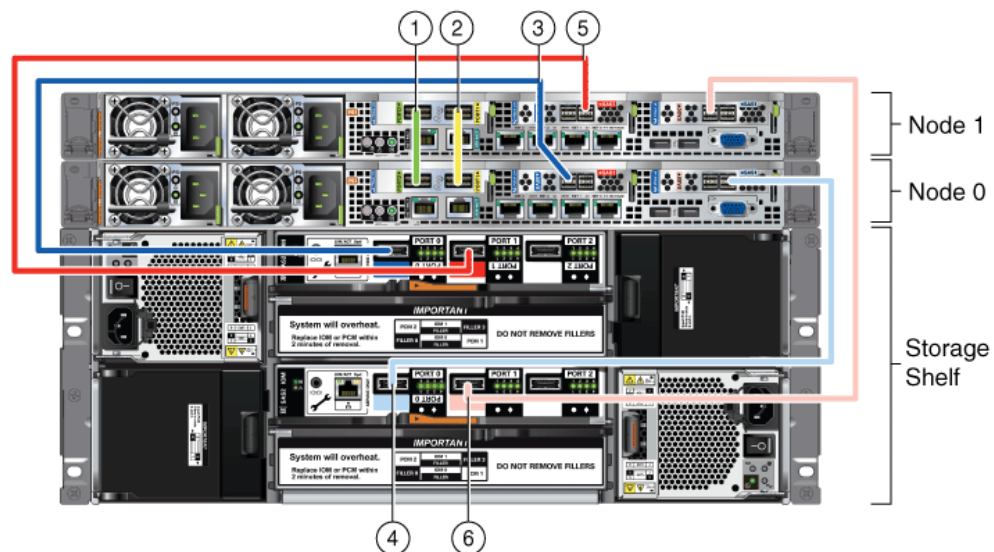

Table 3-1 Description of Callouts for Cabling Oracle Database Appliance X5-2 With Single Storage Shelf

Callout Number	Description
1	Green InfiniBand Cable (Oracle Database Appliance X5-2) <ul style="list-style-type: none"> From: Node 0, PCIe slot 1, PORT2 To: Node 1, PCIe slot 1, PORT2
2	Yellow InfiniBand Cable (Oracle Database Appliance X5-2) <ul style="list-style-type: none"> From: Node 0, PCIe slot 1, PORT1 To: Node 1, PCIe slot 1, PORT1
3	Dark blue SAS cable: <ul style="list-style-type: none"> From: Node 0, PCIe slot 2, SAS0 To: Storage shelf, top I/O port 0
4	Light blue SAS cable: <ul style="list-style-type: none"> From: Node 0, PCIe slot 3, SAS1 To: Storage shelf, bottom I/O port 0
5	Dark red SAS cable: <ul style="list-style-type: none"> From: Node 1, PCIe slot 2, SAS1 To: Storage shelf, top I/O port 1
6	Light red SAS cable: <ul style="list-style-type: none"> From: Node 1, PCIe slot 3, SAS0 To: Storage shelf, bottom I/O port 1

 **Note:**

The back panel of each node contains three PCIe generation 3 terminal slots, with two sockets in each slot. The PCIe slots are labeled **X PCIe3**, where **X** is the PCIe slot number.

Attaching Cables for Oracle Database Appliance Models X4-2

Use the diagram in this topic to understand how to attach cable connections between ports on Oracle Database Appliance model X4-2.

The following figure illustrates the cable connections between ports on Oracle Database Appliance model X4-2 in a single storage shelf.

Figure 3-2 Interconnects and Cables for Single Storage Shelf on Oracle Database Appliance X4-2

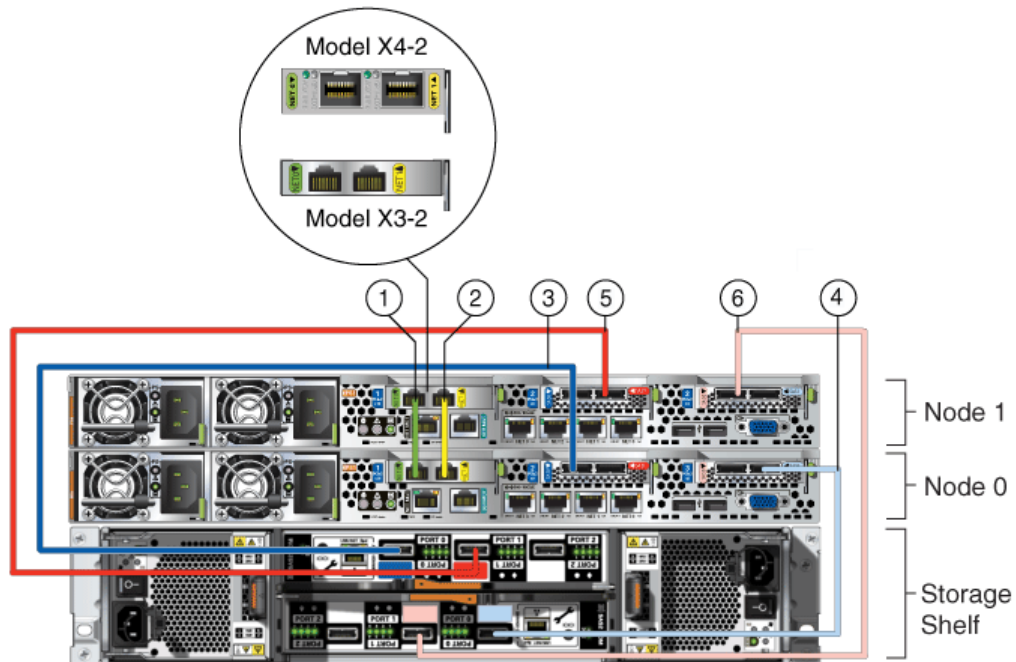

Table 3-2 Description of Callouts for Cabling Oracle Database Appliance X4-2 With Single Storage Shelf

Callout Number	Description
1	Green-labelled twinax cable (Oracle Database Appliance X4-2): <ul style="list-style-type: none"> From: Node 0, PCIe slot 1, NET0 To: Node 1, PCIe slot 1, NET0
2	Yellow-labeled twinax cable (Oracle Database Appliance X4-2) <ul style="list-style-type: none"> From: Node 0, PCIe slot 1, NET1 To: Node 1, PCIe slot 1, NET1
3	Dark blue SAS cable: <ul style="list-style-type: none"> From: Node 0, PCIe slot 2, SAS0 To: Storage shelf, top I/O port 0
4	Light blue SAS cable: <ul style="list-style-type: none"> From: Node 0, PCIe slot 3, SAS1 To: Storage shelf, bottom I/O port 0
5	Dark red SAS cable: <ul style="list-style-type: none"> From: Node 1, PCIe slot 2, SAS1 To: Storage shelf, top I/O port 1
6	Light red SAS cable: <ul style="list-style-type: none"> From: Node 1, PCIe slot 3, SAS0 To: Storage shelf, bottom I/O port 1

▲ Caution:

Do not attach cables to ethernet ports in the I/O modules labeled "SERVICE ONLY" when cabling the system. These ports are intended for use by service engineers only. You must use Oracle Appliance Manager to manage Oracle Database Appliance storage.

✎ Note:

The back panel of each node contains three PCIe generation 3 terminal slots, with two sockets in each slot. The PCIe slots are labeled **X PCIe3**, where **X** is the PCIe slot number.

Cabling Oracle Database Appliance to Connect to Fiber Public Networks (Optional)

You can configure X5-2 appliances to use fiber connections for the public network.

For Oracle Database Appliance X5-2 installations, if you want to use fiber connections between Oracle Database Appliance and your public network, then you must cable the interconnect by using the green and yellow copper ports (onboard ports `net0` and `net1`). The green and yellow Category 6 (Cat 6) interconnect cables for these ports ship with the base system.

For Oracle Database Appliance X5-2, if you want to use a fiber port connection, then you must replace the InfiniBand cards with 10 GbE SFP+ (fiber) cards. Fiber ports do not exist in the base configuration for X5-2. You must re-image Oracle Database Appliance X5-2 after you replace the PCIe cards. After you replace the cards, Oracle Database Appliance auto-detects the network configuration changes.

▲ Caution:

If you replace the InfiniBand interconnect cards on Oracle Database Appliance X5-2, then you disable the Oracle Database Appliance in-memory fault tolerance feature. Also, interconnect bandwidth is reduced from 40 GB to 10 GB. If you have Oracle RAC databases, then you may experience slower intercommunication speeds, depending on the system workload.

In the following figure, callouts 1 and 2 show how to cable the interconnect between Node 1 and Node 0 using the green and yellow copper ports (onboard ports `net0` and `net1`) to use a fiber public network. Note that the illustration shows the rear panel of an Oracle Database Appliance X4-2. The rear panel of the Oracle Database Appliance X5-2 is slightly different, but the interconnect cabling is the same.

Figure 3-3 Interconnects When Using Fiber Connections to the Public Network on Oracle Database Appliance Models X5-2

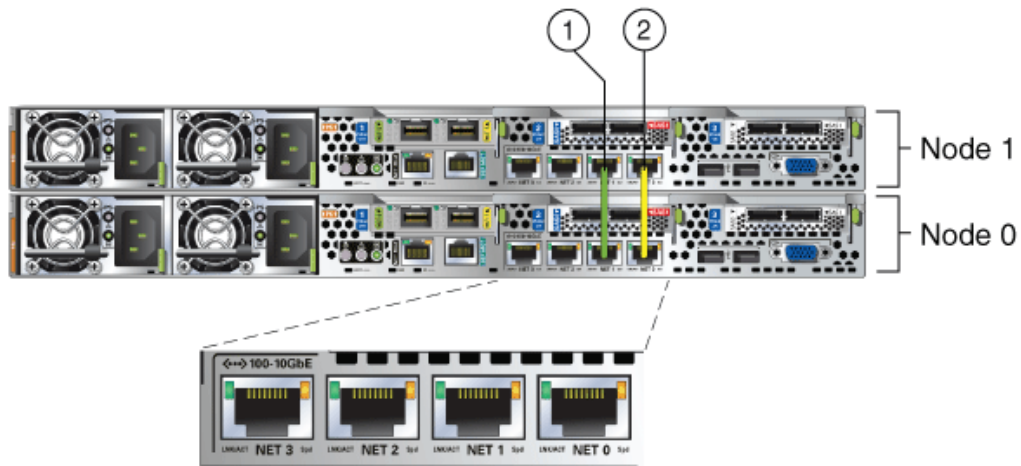

The following sections show the cabling options for 10 GbE SFP+ PCI cards.

Fiber Cables

For optical cables, you must purchase either Short Range (SR) or Long Range (LR) SFP+ transceivers for each of the network ports, and then plug in the appropriate optical cable. Currently, Oracle sells both the SR and LR SFP+ transceivers. In addition to these transceivers, you must purchase the appropriate LC-LC terminated fiber optic cables from a third-party vendor.

Name	Oracle Sun Part Number
10 GbE Transceiver SR (SFP+)	X2129A-N
10 GbE Transceiver LR (SFP+)	X5562A-Z

Copper Cables

You can purchase the following copper cables from Oracle Sun. These cables have built-in SFP+ connectors:

Name	Length	Oracle Sun Part Number
TwinAx 1m	1m	X2130-1M
TwinAx 3m	3 m	X2130-3M
TwinAx 5m	5m	X2130-5M

Attaching a Storage Expansion Shelf to Oracle Database Appliance

Review these topics to install and cable a storage expansion shelf for Oracle Database Appliance.

Topics:

- [About Attaching and Cabling Storage Shelves](#)
Review these options and best practices for adding storage shelves for Oracle Database Appliance X3-2, X4-2 and X5-2.
- [Installing and Cabling a Storage Expansion Shelf](#)
Use this procedure to install and cable a storage expansion shelf for Oracle Database Appliance

About Attaching and Cabling Storage Shelves

Review these options and best practices for adding storage shelves for Oracle Database Appliance X3-2, X4-2 and X5-2.

Storage Shelf Options for Oracle Database Appliance X3-2, X4-2 and X5-2

Oracle Database Appliance models X3-2, X4-2, and X5-2 can be shipped with one or two storage shelves. You can obtain the second shelf at a later time to double your storage capacity.

If you originally deployed Oracle Database Appliance with one storage shelf, then you can add a storage expansion shelf at any time without having to shut down your databases or applications.

Best Practice Guidelines for Adding Storage Expansion Shelves

Oracle recommends that you add a storage expansion shelf when you have relatively little activity on your databases. When the system discovers the new storage, Oracle ASM automatically rebalances the disk groups. The rebalance operation may degrade database performance until the operation completes.

Caution:

Review cabling instructions to ensure that you have carried out cabling correctly. Incorrect connections can cause data loss when adding a storage expansion shelf to Oracle Database Appliance with existing databases.

Do not attach cables to Ethernet ports in the I/O modules labeled "SERVICE ONLY" when cabling the system. These ports are intended for use by service engineers only.

Installing and Cabling a Storage Expansion Shelf

Use this procedure to install and cable a storage expansion shelf for Oracle Database Appliance

1. Place the storage expansion shelf below your Oracle Database Appliance, if possible, or else close enough to connect the provided cables.

The storage expansion shelf normally sits at the bottom of Oracle Database Appliance, beneath the storage shelf. However, because racks should always be provisioned from the bottom up, that space may be unavailable. In that case, to avoid re-rack mounting the entire system, you can position the storage expansion shelf above the server nodes, or in a different, but adjacent, rack.

2. Install the extension storage shelf in exactly the same manner as the original storage shelf.
3. Use the figures in this topic to assist you to cable the storage expansion shelf for your Oracle Database Appliance model.

 **Caution:**

Incorrect connections can cause data loss when adding a storage expansion shelf to Oracle Database Appliance with existing databases.

4. Attach the supplied power cords. Refer to the section "Attaching Power Cords and Initializing Components" to obtain information and see figures showing how to attach power cords.

Figures Showing How to Cable a Storage Expansion Shelf

The following figure shows you how to insert the required cables into the storage expansion shelf of Oracle Database Appliance. The cables for the two nodes and the original storage shelf are included in the illustration for reference.

The cables are color-coded. Match the colors of the labels at the ends of each cable with the colored line shown in the following illustration. Also match the cable colors to the background colors of the socket identification labels.

You can also use the callouts in the diagrams and the callout table that follows the diagrams to identify the cables and ports. Because all cables with the same terminations are interchangeable, you can ignore the color coding.

 **Note:**

The back panel of each node contains three PCIe generation 3 terminal slots, with two sockets in each slot. The PCIe slots are labeled **X PCIe3**, where **X** is the PCIe slot number. Review the callout table that follows the figures for more information.

Caution:

Do not attach cables to Ethernet ports in the I/O modules labeled "SERVICE ONLY" when cabling the system. These ports are intended for use by service engineers only.

See Also:

[Attaching Power Cords and Initializing Components](#)

To review information about installing optional components for Oracle Database Appliance, see the section "Optional Component Installation" in Chapter 4 of *Oracle Database Appliance Owner's Guide*.

Attaching Peripheral Devices

Complete this task if you have direct access to Oracle Database Appliance and you intend to use a locally connected monitor, keyboard and mouse.

Oracle Database Appliance is not equipped with human-computer interface devices, such as a monitor or keyboard. If you want to log in locally, instead of through a network, then you must attach interface devices.

Attach a monitor to the graphics card port, and attach a keyboard and a mouse to the USB ports. Refer to the figure and table to identify the ports.

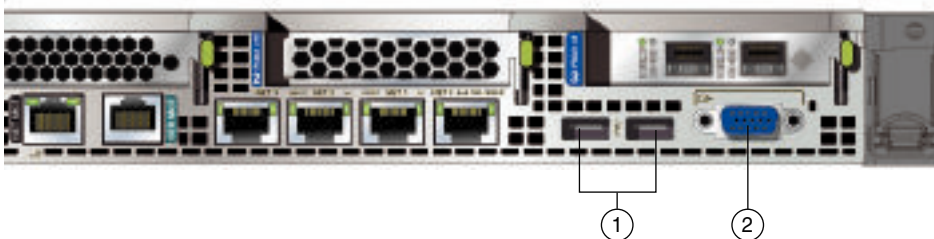

In the figure, callout 1 identifies the ports for the keyboard and mouse. Callout 2 identifies the monitor port.

Table 3-4 Peripheral Device Connections for Oracle Database Appliance

Callout Number	Description
1	USB ports for the keyboard and mouse
2	Graphics card port for the monitor

Attaching Power Cords and Initializing Components

Attach power cords for Oracle Database Appliance.

Caution:

Before plugging in the power cords, ensure that the electrical outlets providing the power are grounded.

If you use only a single AC circuit, then connect both power cords for each component to that circuit. If you want to maintain N+1 power supply redundancy, then use two separate AC circuits. Connect one power cord from each AC circuit into each component.

For more information about cabling with the supplied Cable Management Arm, refer to *Oracle Database Appliance Owner's Guide*.

Powering On Oracle Database Appliance the First Time

Use this procedure to power on Oracle Database Appliance.

Before starting to power on the appliance, make sure that all of the required power cables are attached to both Oracle Database Appliance nodes, and to all storage shelves, if they are included with your appliance.

Note:

After you connect power cords, the green SP OK light-emitting diode (LED) lights blink for a few minutes, and then turn to steady ON. The cooling fans also may turn on. However, these events do not indicate that the system is started. You must complete all of the steps in this section to turn on the appliance properly. Read through the entire section to understand the sequence required for initial system startup.

1. Power on the storage shelves. If attached, switch each storage shelf storage power supply On/Off switch to the On position.

Each storage shelf has two power switches on the rear panel. One switch is on the right side, and one switch is on the left side. Turn on both power switches.

The storage disks begin to initialize, which can take several minutes.

2. Check the Green SP OK LEDs on the storage shelves and the server nodes to see if they are fully initialized. When they are all fully initialized, push the recessed power button on each node to turn it on.

 **Note:**

The fully-initialized state is indicated by the green SP OK LEDs staying steadily lit. If any of the green LED lights on the server nodes and on any attached storage nodes are still blinking, then wait for them to complete their initialization steps. Do not power on the server nodes (Node 0 and Node 1) until the storage shelves are fully initialized.

Refer to the figures and to the following callout table to identify the power button and the system initialization status indicator lights:

Table 3-5 Description of Callouts for Powering On Oracle Database Appliance

Callout	Function
1	SP OK LED light, located on the front panel of each node.
2	Recessed On/Off power button, which is located on the front panel for each node (Node 0 and Node 1). Push this button only once. Do not repeatedly push the power button.
3	Green Power OK LED for a node, located on the node's front panel. These lights must be in the steady ON position (Green light does not blink) before you log on to the system.

Figure 3-5 Front of Oracle Database Appliance Models X3-2, X4-2, and X5-2: Power Panel

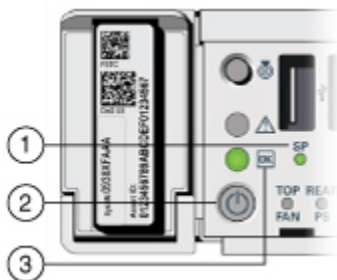
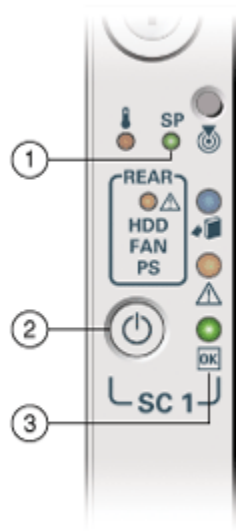

Figure 3-6 Front of Oracle Database Appliance Version 1: Power Panel



3. Wait for Oracle Database Appliance to complete startup.

 **Note:**

Do not repeatedly push the power buttons. Startup can take several minutes to complete.

Oracle Database Appliance is ready for use when the green Power OK LEDs (callout 3) on the front of both system nodes remain steadily on.

4. For X5-2, X4-2, and X3-2 models of Oracle Database Appliance: To ensure that the storage and interconnect is properly configured, log into the console as `root` and run the following `oakcli validate` command:

```
/opt/oracle/oak/bin/oakcli validate -c storagetopology
```

Defining Your Public Network Interface Type

Understand how you can define the public network interface type before deploying the appliance.

For Oracle Database Appliance X5-2 and X6-2 High-Availability non-InfiniBand deployments, the system by default, configures the fiber cards as public network, and copper cards as private network.

Optionally, before provisioning the appliance, if you want to switch the public network to copper, then follow these steps:

1. Log into both nodes as `root`.
2. Configure the network.

For bare metal deployments, run the command on both nodes:

```
# /opt/oracle/dcs/bin/odacli configure-network -publicNet copper
```

For Virtualized Platform deployments, run the command on both nodes:

```
# oakcli configure network -publicNet copper
```

For Oracle Database Appliance X4-2, the system by default, configures the copper cards as public network, and fiber cards as private network.

Optionally, before provisioning the appliance, if you want to switch the public network to fiber, then follow these steps:

1. Log into both nodes as `root`.
2. Configure the network.

For bare metal deployments, run the command on both nodes:

```
# /opt/oracle/dcs/bin/odacli configure-network -publicNet fiber
```

For Virtualized Platform deployments, run the command on both nodes:

```
# oakcli configure network -publicNet fiber
```

Configuring Oracle Integrated Lights Out Manager

Configure Oracle Integrated Lights Out Manager (Oracle ILOM) to manage Oracle Database Appliance independent of the operating system.

Oracle ILOM provides alternate ways to restart and troubleshoot Oracle Database Appliance.

You must set up the following items first to configure Oracle ILOM:

- A name and IP address
- A password to replace the default Oracle ILOM password
- Access to a management network, using an assigned netmask
- An Ethernet cable connected from the NET MGT port to the management network

In the default configuration, Dynamic Host Configuration Protocol (DHCP) is enabled in Oracle ILOM and the DHCP server automatically assigns network settings. To determine the IP address or host name assigned by the DHCP server, use the network tools provided with the DHCP server.

If you do not use DHCP, then use the custom option in Oracle Database Appliance Manager Configurator to assign IP addresses and host names to Oracle ILOM when you deploy your database.

 **Note:**

If you have not enabled DHCP, then you must complete Oracle Database Appliance configuration to access Oracle ILOM.

To connect to the Oracle ILOM, use one of the following two methods:

1. Log in using a web interface by completing these steps:
 - a. Using a client system's browser, enter the IP address or host name assigned by DHCP into the browser address field and press **Enter**.
 - b. At the login page, enter the default user name, `root` and the default password, `changeme`.

The Oracle ILOM web interface appears.

2. Log in using a command-line interface (CLI) by completing these steps:
 - a. Using a client system, establish a secure shell (SSH) connection by entering the following on the command line:

```
ssh -l root sp_ip_address
```

where `sp_ip_address` is the IP address assigned by DHCP.

- b. Enter the default user name, `root`, and the default password, `changeme`.

The Oracle ILOM CLI prompt appears.

Troubleshooting the ILOM Configuration

If the ILOM is not working, then ensure that the ILOM NIC is enabled and that `ipv4` is enabled.

You can configure the ILOM with the IPMI tool or through the BIOS. The following describes how to use the IPMI tool:

1. Open the IPMI tool.

```
# ipmitool -I open sunoem cli
```

2. Go to `SP/network` and verify that the port is enabled:

```
cd /SP/network
```

3. If the port is not enabled, then enable the port.

```
set state=enabled
```

4. In `SP/network`, verify that `ipv4` is enabled.

5. If `ipv6` is enabled, then disable `ipv6` and enable `ipv4`

```
# ipmitool -I open sunoem cli "set /SP/network/ipv6 state=disabled"  
# ipmitool -I open sunoem cli "set /SP/network/ipv4 state=enabled"
```

4

Provisioning Oracle Database Appliance Bare Metal System

Understand the process to configure Oracle Database Appliance bare metal system.

The Browser User Interface is the preferred method of deploying your bare metal platform configuration. The Browser User Interface provides all of the fields necessary to provision Oracle Database Appliance, including configuring the system, network, database, and Oracle Auto Service Request (Oracle ASR). If you prefer to use the command-line interface, you must create a JSON file to configure the deployment options.

- [Plumbing the Network](#)
Plumb the Oracle Database Appliance network with the public internet protocol (IP) information assigned to a node, to enable provisioning of the Oracle Database Appliance software.
- [Verifying Cabling and Network Connections](#)
After powering on Oracle Database Appliance, verify that the network connections are set up correctly.
- [Downloading Oracle Database Appliance Software](#)
Download Oracle Database Appliance software and copy to a temporary location before applying updates to your appliance.
- [Installing Oracle Database Appliance Software](#)
Install Oracle Database Appliance software, before creating the appliance.
- [Creating the Appliance](#)
Create the appliance using the Browser User Interface.

Plumbing the Network

Plumb the Oracle Database Appliance network with the public internet protocol (IP) information assigned to a node, to enable provisioning of the Oracle Database Appliance software.

1. Connect to Oracle ILOM remote console, then log into Oracle Database Appliance as root.
2. Run the command `configure-firstnet` on **both** nodes.

```
# /opt/oracle/dcs/bin/odacli configure-firstnet
Using bonding public interface (yes/no) [yes]:
Select the Interface to configure the network on (btbond1)
[btbond1]:
Configure DHCP on btbond1 (yes/no) [no]:
INFO: You have chosen Static configuration
Use VLAN on btbond1 (yes/no) [no]:
```

3. Complete the network configuration as prompted and configure the public network interface. Also provide the netmask and gateway IP address.

You use this network connection to transfer the software to the server node.

Example 4-1 Example of a Bonded Configuration

For a bonded configuration, answer `yes` to using a bonding public interface and configure the first network to use a `btbond1` interface without configuring DHCP.

```
# /opt/oracle/dcs/bin/odacli configure-firstnet
Select the Interface to configure the network on (btbond1 btbond2
sfpbond1) [btbond1]:
Configure DHCP on btbond1 (yes/no) [no]:
INFO: You have chosen Static configuration
Use VLAN on btbond1 (yes/no) [no]:
Enter the IP address to configure : 10.209.13.109
Enter the Netmask address to configure : 255.255.252.0
Enter the Gateway address to configure[10.209.12.1] :
INFO: Plumbing the IPs now
INFO: Restarting the network
Shutting down interface btbond1: [ OK ]
Shutting down interface btbond2: [ OK ]
Shutting down interface p3p1: [ OK ]
Shutting down interface p3p2: [ OK ]
Shutting down interface sfpbond1: [ OK ]
Shutting down loopback interface: [ OK ]
Bringing up loopback interface: [ OK ]
Bringing up interface btbond1: Determining if ip address 10.209.13.109
is already in use for device btbond1...
[ OK ]
Bringing up interface btbond2: [ OK ]
Bringing up interface sfpbond1: [ OK ]
```

Example 4-2 Example of a Non-Bonded Configuration

To create a non-bonded configuration and disable VLAN capabilities, answer `no` to using a bonding public interface.

```
# /opt/oracle/dcs/bin/odacli configure-firstnet
Using bonding public interface (yes/no) [yes]: no
INFO: Breaking the bonding on btbond1
INFO: remove bonding module: rmmmod bonding
INFO: remove slave setup in /etc/sysconfig/network-scripts/ifcfg-em2
INFO: remove slave setup in /etc/sysconfig/network-scripts/ifcfg-em3
INFO: Restarting the network
Shutting down interface em1: [ OK ]
Shutting down loopback interface: [ OK ]
Bringing up loopback interface: [ OK ]
Bringing up interface em1: [ OK ]
Bringing up interface em2: [ OK ]
Bringing up interface em3: [ OK ]
INFO: Restarting the DCS agent
initdcsagent stop/waiting
initdcsagent start/running, process 57629
Select the Interface to configure the network on (em2 em3) [em2]:
```

```
Configure DHCP on em2 (yes/no) [no]:
INFO: You have chosen Static configuration
Enter the IP address to configure : 10.31.102.101
Enter the Netmask address to configure : 255.255.240.0
Enter the Gateway address to configure[10.31.96.1] :
INFO: Plumbing the IPs now
INFO: Restarting the network
Shutting down interface em1: [ OK ]
Shutting down interface em2: [ OK ]
Shutting down interface em3: [ OK ]
Shutting down loopback interface: [ OK ]
Bringing up loopback interface: [ OK ]
Bringing up interface em1: [ OK ]
Bringing up interface em2: Determining if ip address 10.31.102.101 is
already in use for device em2...
[ OK ]
Bringing up interface em3: [ OK ]
```

Example 4-3 Example of Configuring VLAN

```
# /opt/oracle/dcs/bin/odacli configure-firstnet
Using bonding public interface (yes/no) [yes]:
Select the Interface to configure the network on (btbond1) [btbond1]:
Configure DHCP on btbond1 (yes/no) [no]:
INFO: You have chosen Static configuration
Use VLAN on btbond1 (yes/no) [no]:yes
Configure VLAN on btbond1, input VLAN ID [2 - 4094] 122
INFO: using network interface btbond1.122
Enter the IP address to configure : 192.0.2.24
Enter the Netmask address to configure : 192.0.2.24
Enter the Gateway address to configure[192.0.2.24] :
INFO: Restarting the network
Shutting down interface btbond1: [ OK ]
Shutting down interface em1: [ OK ]
Shutting down interface plp1: [ OK ]
Shutting down interface plp2: [ OK ]
Shutting down loopback interface: [ OK ]
Bringing up loopback interface: [ OK ]
Bringing up interface btbond1:
Determining if ip address 192.0.2.24 is already in use for device
btbond1...
[ OK ]
Bringing up interface em1: [ OK ]
Bringing up interface plp1:
Determining if ip address 192.0.2.24 is already in use for device
plp1...
[ OK ]
Bringing up interface plp2:
Determining if ip address 192.0.2.24 is already in use for device
plp2...
[ OK ]
Bringing up interface btbond1.122:
Determining if ip address 192.0.2.24 is already in use for device
btbond1.122...
```

[OK

```
INFO: Restarting the DCS agent
initdcsagent stop/waiting
initdcsagent start/running, process 32104
```

Verifying Cabling and Network Connections

After powering on Oracle Database Appliance, verify that the network connections are set up correctly.

Run the validation scripts only on Oracle Database Appliance HA models.

1. Log into the Oracle Database Appliance console and access the server node with user name as `root` and password `welcome1`.
2. Run validation scripts on both nodes, to verify cabling. For example:

```
# /opt/oracle/dcs/bin/odacli validate-storagetopology
INFO : ODA Topology Verification
INFO : Running on Node0
INFO : Check hardware type
SUCCESS : Type of hardware found : X7-2
INFO : Check for Environment(Bare Metal or Virtual Machine)
SUCCESS : Type of environment found : Bare Metal
INFO : Check number of Controllers
SUCCESS : Number of ahci controller found : 1
SUCCESS : Number of External SCSI controllers found : 2
INFO : Check for Controllers correct PCIe slot address
SUCCESS : Internal RAID controller :
SUCCESS : External LSI SAS controller 0 : 3b:00.0
SUCCESS : External LSI SAS controller 1 : 5e:00.0
INFO : Check if JBOD powered on
SUCCESS : 2JBOD : Powered-on
INFO : Check for correct number of EBODS(2 or 4)
SUCCESS : EBOD found : 4
INFO : Check for External Controller 0
SUCCESS : Cable check for port 0 on controller 0
SUCCESS : Cable check for port 1 on controller 0
SUCCESS : Overall Cable check for controller 0
INFO : Check for External Controller 1
SUCCESS : Cable check for port 0 on controller 1
SUCCESS : Cable check for port 1 on controller 1
SUCCESS : Overall Cable check for controller 1
INFO : Check for overall status of cable validation on Node0
SUCCESS : Overall Cable Validation on Node0
SUCCESS : JBOD0 Nickname set correctly
SUCCESS : JBOD1 Nickname set correctly
```

3. If there is a storage expansion shelf connected to the appliance, then power it on. Run the `storagetopology` command on both nodes to make sure the cabling is correct. For example:

```
# /opt/oracle/dcs/bin/odacli validate-storagetopology
INFO : ODA Topology Verification
INFO : Running on Node0
```

Enter the `root` password, and then copy the file.

```
put software_file
```

For example, for release 19.10:

```
put odacli-dcs-19.10.0.0.0-210208-GI-19.10.0.0.zip
put odacli-dcs-19.10.0.0.0-210208-DB-19.10.0.0.zip
```

The GI and RDBMS Clone files are copied to the temporary location on the appliance. You can update the repository, and create the appliance, as explained in the next topic.

Installing Oracle Database Appliance Software

Install Oracle Database Appliance software, before creating the appliance.

Ensure that the Oracle Database Appliance patches are downloaded and available for updating the repository, as described in the topic *Downloading Oracle Database Appliance Software*.

1. Verify the current system version by running the following command on **both** nodes:

```
[root@oda1 opt]# /opt/oracle/dcs/bin/odacli describe-component -v
```

On a single-node Oracle Database Appliance system, run the command `odacli describe-component` without the `-v` option.

```
[root@oda1 opt]# /opt/oracle/dcs/bin/odacli describe-component
```

2. Update the repository with Oracle Grid Infrastructure and Database software.

```
[root@oda1 opt]# /opt/oracle/dcs/bin/odacli update-repository -
f /tmp/GI_clone_file,/tmp/DB_clone_file
```

For example, for release 19.10:

```
[root@oda1 opt]# /opt/oracle/dcs/bin/odacli
update-repository -f /tmp/odacli-dcs-19.10.0.0.0-210208-
DB-19.10.0.0.0.zip,/tmp/odacli-dcs-19.10.0.0.0-210208-GI-19.10.0.0.zip
```

3. Confirm that the repository update is successful:

```
[root@oda1 opt]# /opt/oracle/dcs/bin/odacli describe-job -i job_ID
```

4. Delete the software zip files from the temporary location on the appliance to save space:

```
[root@oda1 opt]# rm software_file
rm: remove regular file software_file? y
```

You have now updated the repository with the Oracle Database Appliance software, and can create your appliance, as described in the next topic.

Creating the Appliance

Create the appliance using the Browser User Interface.

Ensure that ports 7070 and 7093 on the network between Oracle Database Appliance and the client machine, are open.

1. Navigate to the Browser User Interface. You are prompted to set the password for the `oda-admin` user.

```
https://ODA-host-ip-address:7093/mgmt/index.html
```

2. Log into the Browser User Interface with the new password.

When you launch the Browser User Interface on an unconfigured appliance, the Appliance page notifies you that the appliance is not configured and provides a link to the pages needed to configure and create the appliance.

Note:

If you face any issues when logging into the Oracle Database Appliance Browser User Interface, then see the topic *Errors When Logging into the Browser User Interface* in the chapter *Troubleshooting Oracle Database Appliance*.

3. Click **Create Appliance**.
4. In the Create Appliance page, if you want to create the appliance from a saved configuration, click **Browse**, and select the JSON file. The information from the saved configuration file is loaded. You can retain or edit the fields. Otherwise, manually, provide the values to create the appliance.
5. In the System Information section, specify the values as follows.
 - a. **Host Name:** Enter the host name.

The host name can contain alphanumeric characters and dashes (-), but cannot start with a number or dash (-) or end with dash (-). Do not exceed 30 characters.
 - b. **Domain Name:** Enter the domain name.
 - c. **Region:** Select the region of the world where the Oracle Database Appliance is located.
 - d. **Time Zone:** Select the time zone where the Oracle Database Appliance is located.
 - e. (Optional) **DNS Servers:** Enter addresses for one or more DNS servers.
 - f. (Optional) **NTP Servers:** Enter addresses for one or more NTP servers.
 - g. **Diskgroup Redundancy:** If there are two disks, then you can select the disk group redundancy as Normal or Flex. To select the the redundancy as **High**, there must exist more than four disks, and a quorum disk. If five or more disks

are configured, then the quorum disk is not required. Select **Normal**, **High**, or **Flex**, as per your deployment requirement.

The Flex parameter defines the disk group redundancy. Flex redundancy requires at least 3 storage devices, including a quorum. For a database to be placed on Oracle ASM, you can set the database redundancy during its creation. For a database to be placed on Oracle ACFS, the database inherits the redundancy of the ACFS file system. You can specify an ACFS file system redundancy during its creation. You can set the disk group redundancy only during appliance creation. The database redundancy can be set anytime you create the database.

The redundancy level for DATA, RECO, and FLASH can be set to Normal, Flex, or High based on whether there are two, four, or more disks.

Note: For Oracle Database Appliance hardware models other than X8-2, the redundancy level for REDO is always High.

- h. Data Storage Percentage:** Enter a whole number between 10 and 90 to define the percentage of storage reserved for DATA, the remainder is reserved for RECO. For example, if you enter 80, then 80% of the storage for DATA and 20% for RECO.
- i. System Password and Confirm Password:** Enter the system password in both fields.

The system password is the password set for UNIX and `root` users. The password must begin with an alpha character and cannot contain quotation marks. Do not exceed 30 characters.

- 6.** In the Network Information section, configure the primary client access network, virtual networks, and an Oracle Integrated Lights Out Manager (Oracle ILOM) network. You are only required to configure the client access network. The ILOM configuration is optional if you already configured the ILOM for the appliance and you do not need to make changes.

Specify the following, depending on whether it is a single-node or two-node Oracle Database Appliance deployment:

- a. Client Access Network Host Name:** For Node0, enter the host name for the primary client access network.
- b. Client Access Network IP Address:** For Node0, enter the IP address for the primary client access network.
- c. VIP Name for Node0:** Enter the name of the virtual IP network for Node0.
- d. VIP IP Address for Node0:** Enter the virtual IP address that resides on Node0 and is shared between the nodes.
- e. VIP Name for Node1:** Enter the name of the virtual IP network for Node0.
- f. VIP IP Address for Node1:** Enter the virtual IP address that resides on Node1 and is shared between the nodes.
- g. (Optional) ILOM Host Name:** Enter the name of the Oracle ILOM host for Node0 and Node1.
- h. (Optional) ILOM Network IP Address:** Enter the IP address for the ILOM for Node0 and Node1.
- i. (Optional) ILOM Network Subnet Mask:** Enter the subnet mask address for the ILOM.

- h. Password:** Provide a password for the database.
 - i. Deployment:** Select a deployment type from the list. The options are RAC, RAC-One, or SI (single instance database). If you select a single instance database, then select the node for the SI database deployment.

If you select a single instance database, then you have the option to create the database on either Node0 or Node1. The default is Node0.
 - j. Shape:** Select a database shape from the list.
 - k.** In the **Database Class** field, select a database class from the drop-down list. If an option is not available in the list, it is not supported for the database edition on the Oracle Database Appliance or the version that you selected. The default is OLTP.
 - l.** In the **Storage** field, select **ACFS** or **ASM** from the drop-down list. The default is Oracle ASM.

Oracle 12.1 and later databases can use Oracle ASM storage. Oracle Database 11.2 is only supported on Oracle ACFS.
 - m.** If you specified the disk group redundancy as **Flex**, then you can select the **Database Redundancy** value as **Mirror** or **High**.
 - n. Data Files on Flash Storage:** Select **Yes** or **No**.

This option is only available if the HA system has HDD storage drives.
 - o. Configure EM Express:** Select **Yes** or **No**.

Select **Yes** to configure the Oracle Enterprise Manager Database Express (EM Express) console for Oracle Database 12.2.1.0 or 12.1.0.2 or the Database Control Console for Oracle Database 11.2.0.4. Selecting Yes enables you to use the console to manage the database.
 - p. Character set:** Select a character set.
 - q. National Characterset:** Select a national character set.
 - r. Language:** Select the database language.
 - s. Territory:** Select a territory or location from the list.
 - t.** For Oracle Database Enterprise Edition 18c or later, you can choose to enable Transparent Database Encryption (TDE). Select **Yes** or **No** in the **Enable TDE** option. Specify and confirm the **TDE Password**. By default, the TDE option is disabled.
- 10. (Optional) Configure and enable Oracle ASR on the ASR page.**
- You can configure and enable Oracle Auto Service Request (Oracle ASR) now or later:
- To not enable Oracle ASR during deployment, select **No** and click **Submit**. After deployment, you can configure an internal Oracle ASR or register with an external Oracle ASR Manager from either the Browser User Interface or command-line interface.
 - Internal Oracle ASR: choose to configure Oracle ASR Manager on Oracle Database Appliance or use Oracle ASR Manager configured on another server in the same network as your appliance.
 - External Oracle ASR: If you already have Oracle ASR Manager configured elsewhere, you can register Oracle Database Appliance with your existing Oracle ASR Manager.

- To enable Oracle ASR, select **Yes** and complete the fields:
 - a. **ASR User Name:** Enter the e-mail address associated with the My Oracle Support account under which the server is registered.
 - b. **Password:** Enter the password associated with the My Oracle Support account under which the server is registered.
 - c. **SNMP Version:** Select **V2** or **V3**. V3 is the default and recommended version.
 - d. **HTTP Proxy used for Upload to ASR:** Select **Yes** or **No**.
 - e. **Proxy Server Name:** If you are using a proxy for upload, enter the proxy server name.
 - f. **Proxy Port:** If you are using a proxy for upload, enter the proxy port.
 - g. **(Optional) HTTP Proxy Requires Authentication:** If you are using a proxy for upload, select **Yes** if you require authentication. If you do not require authentication, select **No**.
 - h. **Proxy User Name:** If you are using a proxy for upload, enter the proxy user name.
 - i. **(Optional) Proxy Password:** If you are using a proxy for upload and require authentication, enter the proxy password.
- 11. Click **Submit**. When prompted, click **Yes** to confirm that you want to start the job to deploy the appliance.
- 12. Verify that the appliance is deployed. Run the `odacli describe-system` command. For multi-node deployments, run the command on both nodes.

The job to create the appliance takes time to complete. To monitor the job progress, click the **Activity** tab. Click the job number to view the tasks.

After deployment, the `root` and database users `SYS`, `SYSTEM`, and `PDBADMIN` are set to the system password. The `oracle` and `grid` passwords are set to the default password. Change these passwords to comply with your user security protocols.

5

Oracle Database Appliance Postinstallation Tasks

Complete these administrative tasks after you have deployed software, but before the system is operational.

- [Configuring CPU Core Count](#)
Oracle Database Appliance is delivered with all cores on each server enabled. Follow this procedure to reduce the number of cores, if required.
- [Securing Oracle ILOM Service Processors](#)
Change the Oracle ILOM default password after completing Oracle Database Appliance deployment.
- [Changing Oracle Database Appliance Passwords](#)
After deploying your appliance, ensure that you change the following passwords for securing your system.

Configuring CPU Core Count

Oracle Database Appliance is delivered with all cores on each server enabled. Follow this procedure to reduce the number of cores, if required.

1. To reduce the number of cores, run the following command on Node 0 only:
Set the cores in multiples of 2, for example, 12:

```
[root@oak1 opt]# /opt/oracle/dcs/bin/odacli update-cpucore --cores 12
```

2. Check if the job completed successfully:

```
[root@oak1 opt]# /opt/oracle/dcs/bin/odacli describe-job -i job_ID
```

3. Verify that the core count is updated on both nodes:

```
[root@oak1 opt]# /opt/oracle/dcs/bin/odacli describe-cpucore
```

Securing Oracle ILOM Service Processors

Change the Oracle ILOM default password after completing Oracle Database Appliance deployment.

Do not change the default password until after you have completed software deployment on the Oracle Database Appliance.

Changing Oracle ILOM Password from the Console

1. In the Oracle ILOM console, from the **Administration** menu, select **User Management**, and then navigate to the **User Accounts** subtab.
2. Select **root** user and click **Edit**.
3. Change the `root` user password.

Changing Oracle ILOM Password Using CLI Commands

1. Connect to the Oracle ILOM service processor (SP) through SSH:

```
# ssh -l root SP-ipaddr
```

2. Set the new password:

```
-> set /SP/users/root password=new_password  
Changing password for user /SP/users/root/password...  
Enter new password again: *****  
New password was successfully set for user /SP/users/root
```

Changing Oracle Database Appliance Passwords

After deploying your appliance, ensure that you change the following passwords for securing your system.

Changing the Oracle Installation Owner Passwords

During deployment, the root and database users SYS, SYSTEM and PDBADMIN are set to the system password. After deployment, the oracle and grid passwords are also set to the system password. Change the passwords to comply with your enterprise user security protocols. Refer to the *Oracle Database Appliance Security Guide* and *Oracle Database Security Guide* for information about the required configuration and best practices to secure database systems.

Changing the oda-admin User Password through the Command-Line

1. Log in to the appliance as `root`.
2. Run the `odacli-adm set-credential` command to reset the password. Enter the new password when prompted.

```
# odacli-adm set-credential --password --username oda-admin  
Agent password: new password
```

Changing the the oda-admin User Password through the Browser User Interface

1. Log into the Browser User Interface using the user name `oda-admin`.
2. Click **About**, then **User Settings** in the upper right corner of the Browser User Interface.
3. Enter the password in the Password field and the Password Confirmation field, then click **Submit**.

A confirmation message is displayed.

4. Click **About**, then click **Sign Out**.
5. Log back into the Browser User Interface with the new password.

 **Note:**

The `oda-admin` password expiration period is 90 days.

6

Patching Oracle Database Appliance

To keep Oracle Database Appliance running with the latest software, check for and apply Oracle Database Appliance patch bundles when they are released.

- [About Patching Oracle Database Appliance](#)
Use the Oracle Database Appliance Patch Bundle to patch your appliance.
- [About Patching Pre-Checks](#)
Patching pre-checks are designed to detect and flag problems that might be encountered during patching.
- [Patching Oracle Database Appliance Bare Metal Systems Using the Command-Line](#)
Follow these steps to apply patches to your Oracle Database Appliance bare metal deployment and existing Oracle Database homes, using CLI commands.
- [Patching Oracle Database Appliance Bare Metal Systems Using the Browser User Interface](#)
Upload the Oracle Database Appliance Server Patch to the patch repository, deploy the patch bundle using the Browser User Interface, and then update the DCS agent and components using CLI commands.
- [Updating Oracle Database Appliance Repository with Database Clone Files For Bare Metal Systems](#)
Follow these steps to update the Oracle Database Appliance repository with Oracle Database clone files for the latest release using CLI commands.
- [Patching Existing Database Homes on Bare Metal Systems Using the Browser User Interface](#)
Use the Browser User Interface to patch database homes to the latest release on bare metal systems.
- [Applying Additional Patches and Updates on Bare Metal Systems](#)
Configure additional patch repositories and patch your operating system and databases to ensure that your deployment has the latest updates and security fixes.
- [Cleaning Up the Patch Repository](#)
Use the Browser User Interface or Command Line Interface to delete obsolete or old patches from the repository.
- [About Upgrading to a Different Database Home](#)
Understand how to upgrade to a different database home using either the Browser User Interface or `odacli` commands.

About Patching Oracle Database Appliance

Use the Oracle Database Appliance Patch Bundle to patch your appliance.

Patches offer new features and may improve the functionality of existing features.

! Important:

Starting with Oracle Database Appliance release 19.10, DCS Agent uses MySQL server as its metadata store. MySQL server is automatically installed and configured, during provisioning, when creating the appliance. Similarly, during patching, the `odacli update-dcscomponents` command automatically installs and configures MySQL server. MySQL server processes do not run with `root` operating system user account. Instead, MySQL server processes run with a new operating system user account called `odamysql`. Note that the `odamysql` operating system user is created only for ownership purposes and the `odamysql` user account owns only the MySQL directories. The `odamysql` operating system user cannot log into the appliance. The `odamysql` operating system user account for MySQL ensures role separation between the user owning Oracle databases on the appliance and the metadata used for DCS operations.

About Oracle Database Appliance Patch Bundles

The Oracle Database Appliance Patch Bundle contains the latest patches for DCS Admin, DCS Components, OAK, Oracle Grid Infrastructure, Oracle Database homes, enhancements, and fixes.

The Oracle Database Appliance Release Notes include information about the latest Oracle Database Appliance patch bundle and a list of component versions in the patch bundle. Oracle recommends updating the appliance with the latest Oracle Database Appliance software version to take advantage of new features, fixes, and the latest supported component versions. See the Oracle Database Appliance Release Notes for the upgrade paths.

▲ Caution:

Do not patch Oracle Database Appliance using individual patches for Oracle Grid Infrastructure or Oracle Linux. Also do not use individual infrastructure patches, such as firmware patches. You must only use Oracle Database Appliance patches. If you use patches that are not intended for Oracle Database Appliance, or if you use OPatch, or a similar patching tool, then Oracle Database Appliance inventory is not updated, and you cannot complete future patch updates. If you apply out-of-cycle Oracle Database Release Update (RU), then ensure that you follow the recommendations described in the Readme for the RU.

The patch bundle provides all relevant patches for the entire system, including the following:

- BIOS
- Hardware drivers
- Hardware Management Pack (HWM) and firmware drivers for various components
- Oracle Appliance Manager
- Oracle Linux

- Oracle VM Server
- Java Runtime Environment (JRE)
- Oracle Integrated Lights Out Manager (Oracle ILOM)
- Oracle Database Bundle Patch (BP), Oracle Database Patch Set Update (PSU), and Oracle Database Release Update (RU)
- Oracle Auto Service Request (Oracle ASR)
- Oracle Grid Infrastructure
- Oracle Intelligent Platform Management Interface (Oracle IPMI)
- Network Card Patches for relevant hardware models

About Updating Oracle Linux RPMs

While not recommended, you can update some Oracle Linux RPMs for database nodes. Do not update or customize Oracle Linux kernel, Oracle Optimal Flexible Architecture, Oracle InfiniBand, or related software. Other software may be installed, updated, or customized. However, the Oracle Database Appliance update may not carry newer version dependencies of customized components. Therefore, you might be required to remove and subsequently reapply site-specific changes to successfully update Oracle Database Appliance in the future.

Caution:

For database nodes, do not update the following:

- Oracle Linux Kernel (kernel*)
- Oracle Optimal Flexible Architecture (ofa*)
- Oracle RDMA packages (oracle-rdma-release)

For storage, do not apply any RPM updates.

About Patching Pre-Checks

Patching pre-checks are designed to detect and flag problems that might be encountered during patching.

The pre-checks view the state of the appliance, including the version and hardware specific upgrades, verify that the necessary conditions and checks are complete before attempting an upgrade, and identify conditions that might cause an upgrade to fail. You can avoid potential patching problems by correcting the conditions and resolving the issues before applying the patch.

The pre-checks commands are available on Oracle Database Appliance release 12.2.1.2.0 or later. Update the DCS agent to support the pre-checks commands.

 **Note:**

Patching pre-checks are available only when patching ODACLI stack. If you are patching and migrating from OAKCLI to ODACLI stack for bare metal system, then follow the procedure in the topic *Patching Oracle Database Appliance Bare Metal Systems Using the Command-Line*. For patching Virtualized Platform, see the topic *Patching Oracle Database Appliance Virtualized Platform*.

Components Verified by Patching Pre-Checks

Check	Component Verified
System patching pre-checks	<ul style="list-style-type: none"> Checks that the agent is online on all nodes Checks that there is sufficient space for the update Validates the minimum agent version and validates the patching tag Confirms that a valid patch is in the repository and calculates the patch bundle md5 checksum
Server patching pre-checks	<ul style="list-style-type: none"> Confirms that Oracle Grid Infrastructure patch is installed Confirms that Oracle Clusterware is running on all nodes Performs a check for required components using <code>opatch prereq checkcomponents</code> Analyzes the patch using <code>opatchauto</code> Performs a patch conflict check Checks the available disk space Confirms that the yum repository directory exists Performs a <code>yum check</code> and <code>yum check-update</code> Performs a test (dry run) yum update to check for dependencies in the RPMs
DBHome patching pre-checks	<ul style="list-style-type: none"> Confirms that the Oracle Grid Infrastructure is installed Confirms that Oracle Clusterware is running on all nodes Confirms that the Oracle Grid Infrastructure is upgraded before upgrading other components Validates that there is sufficient space available in local mount Performs a check for required components using <code>opatch prereq checkcomponents</code> Analyzes the patch using <code>opatchauto</code> Performs a patch conflict check and determines if a rollback of database patches is required

Check	Component Verified
Storage pre-checks	Validates storage patch location and tag Validates Oracle ASM disk groups status

Patching Oracle Database Appliance Bare Metal Systems Using the Command-Line

Follow these steps to apply patches to your Oracle Database Appliance bare metal deployment and existing Oracle Database homes, using CLI commands.

To patch your Oracle Database Appliance deployment and your existing database homes to the current release, you must download the Oracle Database Appliance Server Patch and update the repository. To patch your existing databases to the latest release, you do **not** need the Oracle RDBMS clone files for the release. Download Oracle RDBMS clone files for a release only if you want to create new database homes for that release.

Note:

Run the commands in this topic in the same order as documented. Run the `odacli update-dcsadmin`, `odacli update-dcscomponents`, and `odacli update-dcsagent` commands before running the `odacli update-server` command.

Follow these steps to apply patches to your Oracle Database Appliance and update existing database homes.

1. Download the Oracle Database Appliance Server Patch for the ODACLI/DCS stack (patch 32351355) from My Oracle Support to a temporary location on an external client. Refer to the release notes for details about the software for the latest release.

For example, download the server patch for 19.10:

```
p32351355_1910000_Linux-x86-64_1of2.zip
p32351355_1910000_Linux-x86-64_2of2.zip
```

2. Unzip the software — it contains README.html and one or more zip files for the patch.

```
unzip p32351355_1910000_Linux-x86-64_1of2.zip
unzip p32351355_1910000_Linux-x86-64_2of2.zip
```

The zip file contains the following software files:

```
oda-sm-19.10.0.0.0-210216-server1of2.zip
oda-sm-19.10.0.0.0-210216-server2of2.zip
```

3. Copy all the software files from the external client to Oracle Database Appliance. For High-Availability deployments, copy the software files to only one node. The software files are copied to the other node during the patching process. Use the `scp` or `sftp` protocol to copy the bundle.

Example using `scp` command:

```
# scp software_file root@oda_host:/tmp
```

Example using `sftp` command:

```
# sftp root@oda_host
```

Enter the `root` password, and copy the files.

```
put software_file
```

4. Update the repository with the server software:

```
# /opt/oracle/dcs/bin/odacli update-repository -f /tmp/
software_file1,/tmp/software_file2
```

For example, for 19.10:

```
# /opt/oracle/dcs/bin/odacli update-
repository -f /tmp/oda-sm-19.10.0.0.0-210216-server1of2.zip,/tmp/
oda-sm-19.10.0.0.0-210216-server2of2.zip
```

5. Confirm that the repository update is successful:

```
[root@oda1 opt]# /opt/oracle/dcs/bin/odacli describe-job -i job_ID
```

6. Update DCS admin:

```
[root@oda1 opt]# /opt/oracle/dcs/bin/odacli update-dcsadmin -v
19.10.0.0.0
```

7. Update the DCS components:

```
[root@oda1 opt]# /opt/oracle/dcs/bin/odacli update-dcscomponents -v
19.10.0.0.0
```

This command updates the Zookeeper, installs MySQL, migrates metadata from Derby to MySQL and updates other DCS components such as the DCS Agent, DCS CLI, and DCS Controller on Oracle Database Appliance. If the DCS components are updated, then the message "status" : "Success" is displayed on the command line. For failed updates, fix the error and then proceed with the update by re-running the `odacli update-dcscomponents` command. See the topic *Resolving Errors When Updating DCS Components During Patching* about more information about DCS components checks errors.

8. Update the DCS agent:

```
[root@oda1 opt]# /opt/oracle/dcs/bin/odacli update-dcsagent -v
19.10.0.0.0
```

9. Run patching pre-checks:

```
[root@oda1 opt]# /opt/oracle/dcs/bin/odacli create-prepatchreport -
s -v version
```

For example, for 19.10:

```
[root@oda1 opt]# /opt/oracle/dcs/bin/odacli create-prepatchreport -
s -v 19.10.0.0.0
```

10. Verify that the patching pre-checks ran successfully:

```
[root@oda1 opt]# /opt/oracle/dcs/bin/odacli list-prepatchreports
```

For example:

```
[root@oda1 opt]# /opt/oracle/dcs/bin/odacli list-prepatchreports
3797791f-72ac-42b6-8bb8-ed5e5c9b32c1 Patch pre-checks for [OS,
ILOM, GI, ORACHKSERVER] June 30, 2020 6:29:30 AM UTC Running
```

Use the command `odacli describe-prepatchreport` to view details of the pre-patchreport.

11. Apply the server update:

```
[root@oda1 opt]# /opt/oracle/dcs/bin/odacli update-server -v version
```

For example, for 19.10:

```
[root@oda1 opt]# /opt/oracle/dcs/bin/odacli update-server -v
19.10.0.0.0
```

12. Confirm that the server update is successful:

```
[root@oda1 opt]# /opt/oracle/dcs/bin/odacli describe-job -i job_ID
```

13. Update the storage components.

Specify the `-rolling` option to patch shared disks in a rolling fashion.

```
[root@oda1 opt]# /opt/oracle/dcs/bin/odacli update-storage -v
version --rolling
```

For example, for 19.10:

```
[root@odal opt]# /opt/oracle/dcs/bin/odacli update-storage -v
19.10.0.0.0 --rolling
```

14. To patch existing Oracle Database Homes to release 19.10:

- a. Run the patching pre-checks and review the prepatch report. For example:

```
[root@odal opt]# /opt/oracle/dcs/bin/odacli create-
prepatchreport --dbhome --dbhomeid DB_Home_ID -v release_number
[root@odal opt]# odacli describe-prepatchreport -i Job_ID
```

```
[root@odal opt]# /opt/oracle/dcs/bin/odacli create-
prepatchreport --dbhome --dbhomeid 7c67c5b4-f585-4ba9-865f-
c719c63c0a6e -v 19.10.0.0.0
[root@odal opt]# odacli describe-prepatchreport -i
39ef1eeb-70d3-47ad-b3f5-48960ca0607b
```

- b. Update the database home to the latest release:

```
[root@odal opt]# /opt/oracle/dcs/bin/odacli update-dbhome --
dbhomeid DB_Home_ID -v release_number
```

For example, for 19.10:

```
[root@odal opt]# /opt/oracle/dcs/bin/odacli update-dbhome --
dbhomeid 7c67c5b4-f585-4ba9-865f-c719c63c0a6e -v 19.10.0.0.0
```

15. Confirm that the patch jobs are successful:

```
[root@odal opt]# /opt/oracle/dcs/bin/odacli list-jobs
```

16. Delete the software zip files from the temporary location on the appliance to save space:

```
[root@odal opt]# rm software_file
rm: remove regular file software_file? y
```

Related Topics

- [Patching Existing Database Homes on Bare Metal Systems Using the Browser User Interface](#)
Use the Browser User Interface to patch database homes to the latest release on bare metal systems.

Related Topics

- [Oracle Database Appliance Release Notes](#)

Related Topics

- [Resolving Errors When Updating DCS Components During Patching](#)
Understand how to troubleshoot errors when updating DCS components during patching.

Patching Oracle Database Appliance Bare Metal Systems Using the Browser User Interface

Upload the Oracle Database Appliance Server Patch to the patch repository, deploy the patch bundle using the Browser User Interface, and then update the DCS agent and components using CLI commands.

Updating the Patch Repository Using the Browser User Interface

1. Download the Oracle Database Appliance patches from My Oracle Support and save them in a directory on the appliance. See the *Oracle Database Appliance Release Notes* for a list of available patches and links to download the patches.
2. Log into the Browser User Interface with the `oda-admin` user name and password.

```
https://Node0-host-ip-address:7093/management/index.html
```

3. Click **Patch Manager**.
4. In the Update Patch Repository page, enter the absolute file path and patch name, then click **Update Repository** to start the update repository job. You can list more than one file to update to the repository with a comma separated list, without spaces, or you can update each file, one at a time.
5. Click **Activity** to monitor the progress. When the job completes successfully, the Patch Repository is updated.

Updating the DCS Admin and DCS Components After Updating the Repository and Before Patching

Before patching your appliance using the Browser User Interface, you must update the DCS admin and DCS components manually, through CLI commands.

Follow these steps:

1. Update DCS admin:

```
[root@oda1 opt]# /opt/oracle/dcs/bin/odacli update-dcsadmin -v
19.10.0.0.0
```

2. Confirm that the update is successful:

```
[root@oda1 opt]# /opt/oracle/dcs/bin/odacli describe-job -i job_ID
```

3. Update the DCS components:

```
[root@oda1 opt]# /opt/oracle/dcs/bin/odacli update-dcscomponents -v
19.10.0.0.0
```

If the DCS components are updated, then the message "status" : "Success" is displayed on the command line. For failed updates, fix the error and then proceed with the update.

 **Note:**

You must log into the Browser User Interface again after running the `odacli update-dcscomponents` command.

Running Patching Prechecks and Patching Agent, Server, and Storage Using the Browser User Interface

 **Note:**

If your appliance has two nodes, you have the option to update both nodes at the same time or individually. If you update nodes individually, then update Node0 before updating Node1.

1. Do not have any jobs running or pending during the update window.
2. Click the **Appliance** tab, and then click **Patch Manager** in the Browser User Interface.
3. Wait for the Component Details to load. If you just updated the Patch Repository, click **Refresh** in the Component Details section of the page.

After the patch is uploaded to the Patch Repository, the Component Details on the page are updated with the Installed Version and Available Version for each component.

4. On the Patch Manager page, click **Refresh** to refresh the Component Details. Select **Update Server**, then click **Apply Patch** to begin the job to patch the server components. Select **Precheck** if you want to run patching prechecks.

Select **Skip Orachk** to skip ORAchK checks and select **Ignore Precheck Failures** to ignore failures in the prechecks and continue with server patching.

For multi-node systems, select the node to update: All Nodes (default), Node0, or Node1.

The DCS agent is automatically updated whenever the Server or Storage components are updated.

When the job finishes, go to the next step. Click **Activity** for job status.

5. On the Patch Manager page, click **Refresh** to refresh the Component Details. Select **Update Storage**, then click **Apply Patch** to begin the job to patch the storage components. Select **Precheck** if you want to run patching prechecks.

For high-availability environment, you can select the **Rolling** check box to perform rolling patching of storage components.

6. Click **Activity** to monitor the progress, and verify that the job completes successfully.

All patching-related information is logged in the `dcs-agent` log file at `/opt/oracle/dcs/log/dcs-agent.log`.

Updating Oracle Database Appliance Repository with Database Clone Files For Bare Metal Systems

Follow these steps to update the Oracle Database Appliance repository with Oracle Database clone files for the latest release using CLI commands.

To create new databases of a specific release version, you must update the Oracle Database Appliance repository with the RDBMS Clone files for a release. Follow these steps to update the repository with Oracle Database clone files for the latest release.

1. Download the RDBMS Clone software file for a release, for example, `p30403662_199000_Linux-x86-64.zip`, and extract the RDBMS Clone software:

For example, download the RDBMS Clone software patch for 19.10:

```
unzip /tmp/p30403662_199000_Linux-x86-64.zip
odacli-dcs-19.10.0.0.0-210208-DB-19.10.0.0.zip
```

2. Copy all the software files from the external client to Oracle Database Appliance. For High-Availability deployments, copy the software files to only one node. The software files are copied to the other node during the patching process. Use the `scp` or `sftp` protocol to copy the bundle.

Example using `scp` command:

```
# scp software_file root@oda_host:/tmp
```

Example using `sftp` command:

```
# sftp root@oda_host
```

Enter the `root` password, and copy the files.

```
put software_file
```

3. Update the repository with latest release database software:

```
[root@oda1 opt]# /opt/oracle/dcs/bin/odacli update-repository -
f /tmp/odacli-dcs-db-clone-file.zip/
```

For example, for 19.10:

```
[root@oda1 opt]# /opt/oracle/dcs/bin/odacli update-repository -
f /tmp/odacli-dcs-19.10.0.0.0-210208-DB-19.10.0.0.zip
```

Follow the same steps to update the repository with the RDBMS Clone software for other supported database versions such as 12.2, 12.1, and so on.

4. Confirm that the repository update is successful:

```
[root@oda1 opt]# /opt/oracle/dcs/bin/odacli list-jobs
[root@oda1 opt]# /opt/oracle/dcs/bin/odacli describe-job -i job_ID
```

5. Delete the software zip files from the temporary location on the appliance to save space:

```
[root@oda1 opt]# rm software_file
rm: remove regular file software_file? y
```

Patching Existing Database Homes on Bare Metal Systems Using the Browser User Interface

Use the Browser User Interface to patch database homes to the latest release on bare metal systems.

Before patching the database home, upload the RDBMS Clone Files for the database version, to the repository. See *Updating Oracle Database Appliance Repository with Database Clone Files Using the CLI* for the procedure to update the repository with the latest RDBMS Clone Files.

1. Log into the Browser User Interface with the `oda-admin` user name and password.

```
https://Node0-host-ip-address:7093/mgmt/index.html
```

2. Click the **Database** tab, and then click **Patch** on the left pane.
3. Click **Patch**, and then select the Action as **Precheck** to run pre-checks before patching the database.

Click **Activity** for job status.

4. On the Patch page, for the database to be patched, click **View** and select **Pre-patch reports** to view the pre-check report. Fix any errors, and then select Action as **Apply** to patch the database.
5. Verify that the patching job completes successfully.

Related Topics

- [Patching Oracle Database Appliance Bare Metal Systems Using the Command-Line](#)
Follow these steps to apply patches to your Oracle Database Appliance bare metal deployment and existing Oracle Database homes, using CLI commands.

Related Topics

- [Oracle Database Appliance Release Notes](#)

Applying Additional Patches and Updates on Bare Metal Systems

Configure additional patch repositories and patch your operating system and databases to ensure that your deployment has the latest updates and security fixes.

- [Enabling Kernel Updates](#)
Oracle Ksplice enables you to update your systems with the latest kernel security and bug fix updates.
- [Applying Out-of-Cycle Database Patches](#)
The out-of-cycle patching feature enables administrators to patch databases in the Oracle Database Appliance deployment with the latest Oracle Database Release Update, outside of the Oracle Database Appliance releases.

Enabling Kernel Updates

Oracle Ksplice enables you to update your systems with the latest kernel security and bug fix updates.

You can download and install the latest Oracle Ksplice updates (uptrack-updates) with either the local ULN repository or ULN channel.

Follow these steps to install Oracle Ksplice:

1. Register your server with Unbreakable Linux Network (ULN). By default, you are registered for the Oracle Linux Latest channel for your operating system and hardware.
2. Log in to Unbreakable Linux Network:
<https://linux.oracle.com>
3. Ensure that you have access to the Internet on the server where you want to use Ksplice. For example, if you are using a proxy server, then set the proxy server and port values in the shell with commands similar to the following:

```
# export http_proxy=http://proxy.company.com:port  
# export https_proxy=http://proxy.company.com:port
```

4. Register the server:

```
# uln_register
```

5. Set up the local repository as described in the Oracle Ksplice user documentation. This enables you to download the latest Ksplice update packages at regular intervals without requiring a direct connection to the Oracle Uptrack server or to ULN.
6. To update a system to a specific effective kernel version, install the uptrack-updates package for the current kernel.

```
yum -y install uptrack-updates-'uname -r'
```

You can also download the `uptrack-updates` RPM from the Ksplice channel and install the RPM manually. For example:

```
# rpm -Uvh uptrack-  
updates-4.14.35-1902.11.3.1.el7uek.x86_64-20200325-0.noarch.rpm
```

See Also:

Oracle Linux Ksplice User's Guide for information about configuring Oracle Ksplice at:

https://docs.oracle.com/cd/E37670_01/E39380/html/ksplice-enhanced-offline.html

Applying Out-of-Cycle Database Patches

The out-of-cycle patching feature enables administrators to patch databases in the Oracle Database Appliance deployment with the latest Oracle Database Release Update, outside of the Oracle Database Appliance releases.

You can apply Oracle Database Release Update (RU) patches manually using OPatch. Refer to the relevant section in this topic to run the OPatch for your database version.

Note:

The OPatch commands and procedures described in this topic are examples, and may need modifications based on a specific Oracle Database Release Update (RU). Always refer to the Readme of the Oracle Database Release Update (RU) for additional commands and steps.

Note:

It is strongly recommended that you patch your deployment through the Oracle Database Appliance releases, whenever possible.

Note:

You can apply out-of-cycle patches to both baremetal and Virtualized Platform deployments using this procedure.

Using OPatchauto to Manually Patch Oracle Database Release 12c and Later

1. Confirm that the `dcS-agent` and other components are updated to the latest release.

```
# odacli describe-component
# odacli list-dbhomes
```

2. Update OPatch to the latest version, if available:

- a. Download the latest OPatch version from My Oracle Support.
- b. Copy the files to the local host and extract them to the `ORACLE_HOME/OPatch` directory.
- c. Update the OPatch tool as `oracle` user.

```
/bin/rm -rf $ORACLE_HOME/OPatch/
su - oracle -c /usr/bin/unzip -q -o OPatch_zip_location/
p6880880_122010_Linux-x86-64.zip -d $ORACLE_HOME
```

3. Download the latest database patches from My Oracle Support and copy the files to the local host.

```
scp patchfilename root@hostname:directory
```

4. Unzip patches to an empty directory, for example, `/tmp/patchesDir` as `oracle` user.

This creates sub directories under `/tmp/patchesDir` with bug numbers. If the patch you are applying is a Release Update (RU), then the patch directory has multiple sub-directories.

```
/usr/bin/unzip -o location_of_patches/p29301631_180000_Linux-
x86-64.zip -d /tmp/patchesDir
```

5. For Oracle Database Appliance High-Availability deployments, set up SSH Keys for secure connection.
6. Analyze the patches.

```
$ORACLE_HOME/OPatch/patchauto apply
directory_with_patches_extracted -analyze -oh $ORACLE_HOME -
log /tmp/patchAutoAnalyzePatch.log
```

7. As `root` user, apply the patches.

```
$ORACLE_HOME/OPatch/patchauto apply directory_to_extract_patches -
oh $ORACLE_HOME -inplace
```

8. When patching is completed on both nodes, run `utlrp.sql` and `catcon.pl` scripts to recompile invalid objects in the database.
9. Update the registry to ensure that system component values are registered.

```
# odacli update-registry -n dbhome -f
```

Using OPatch to Manually Patch Oracle Database Release 11.2.0.4

1. Confirm that the `dcs-agent` and other components are updated to the latest release.

```
# odacli describe-component
# odacli list-dbhomes
```

2. Update OPatch to the latest version, if available:
 - a. Download the latest OPatch version from My Oracle Support.
 - b. Copy the files to the local host and extract them to the `ORACLE_HOME/OPatch` directory.
 - c. Update the OPatch tool as `oracle` user.

```
/bin/rm -rf $ORACLE_HOME/OPatch
su - oracle -c /usr/bin/unzip -q -o OPatch_zip_location/
p29141056_112040_Linux-x86-64.zip -d $ORACLE_HOME
```

3. Download the latest database patches from My Oracle Support and copy the files to the local host. Unzip the database patches to an empty directory, for example, `/tmp/patchesDir` as `oracle` user. This creates sub directories under `/tmp/patchesDir` with bug numbers. If the patch you are applying is an Oracle Database Release Update (RU), then the patch directory has multiple sub-directories.

```
su - oracle -c '/usr/bin/unzip -o p29141056_112040_Linux-x86-64.zip
-d /tmp/patchesDir'
```

4. Delete bug#2015 if it exists in the inventory.
 - a. Check if bug#2015 exists in the inventory:

```
su - oracle
export ORACLE_HOME=path_to_the_11.2.0.4_ORACLE_HOME
$ORACLE_HOME/OPatch/opatch lspatches | grep -i "OCW" | cut -d
';' -f1
```

- b. The command returns a bug number, for example, 28729234. Navigate to the inventory:

```
cd $ORACLE_HOME/inventory/oneoffs/bug# from above command/etc/
config
```

- c. Check if `inventory.xml` contains a string such as `'bug number="2015"'`. If no match is found, then no action is required, and you can continue with step 6 in this procedure.

```
grep 'bug number="2015"' inventory.xml
echo $? ( the command returns 0, if match found )
```

- d. Take a backup of `inventory.xml`.

```
cp inventory.xml inventory.xml.$(date +%Y%m%d-%H%M)
```

- e. Delete entry like `<bug number="2015" ...>` from `inventory.xml`.

```
sed '/bug number="2015"/d' inventory.xml
```

5. Run prechecks using the `opatch` command for every patch.

```
su - oracle -c '$ORACLE_HOME/OPatch/opatch prereq CheckComponents
-ph /tmp/patchesDir/29301631 -oh $ORACLE_HOME'
su - oracle -c '$ORACLE_HOME/OPatch/opatch prereq
CheckConflictAgainstOH -ph /tmp/patchesDir/29301631 -oh
$ORACLE_HOME'
```

Run both commands for all the sub patches also. If there are any conflicting bugs, then rollback the one-off patches.

6. Apply the patch using the `opatch auto` command.

```
$ORACLE_HOME/OPatch/opatch auto /tmp/patchesDir/29301631 -oh
$ORACLE_HOME -ocmrf /opt/oracle/dcs/rdbaas/config/default-ocm.rsp
```

7. Verify that the database is up and running after applying the patch.

```
/u01/app/18.0.0.0/grid/bin/crsctl status resource ora.on6i.db -n
patched_db
```

8. Run `catbundle.sql` on all databases in this home.

```
su oracle
export ORACLE_HOME=ORACLE_HOME
export ORACLE_HOME=ORACLE_SID
$ORACLE_HOME/bin/sqlplus "/" as sysdba" @$ORACLE_HOME/rdbms/
admin/catbundle.sql
@$ORACLE_HOME/rdbms/admin/catbundle.sql
```

Cleaning Up the Patch Repository

Use the Browser User Interface or Command Line Interface to delete obsolete or old patches from the repository.

About Cleaning Up the Patch Repository

After patching Oracle Database Appliance with the latest patches, old unused clone files may remain and consume space in the repository. Cleanup repository deletes the unused clone/patch files to reclaim space. You can clean up the repository using the Browser User Interface or ODA CLI commands.

Cleaning Up the Patch Repository Using ODACLI command

```
# odacli cleanup-patchrepo [-cl clones] | [-v version [-comp  
component]] | [-l local|-n NodeID]
```

Specify the clone file names and the node from which you want to delete the old patches.

For details about the command options, see the chapter *Oracle Database Appliance Command-Line Interface*.

Cleaning Up the Patch Repository Using the Browser User Interface

Follow these steps to clean up the patch repository:

1. In the Browser User Interface, click **Patch Manager**.
2. Click the **Cleanup Repository** tab, and then click **Refresh** to list the available patches in the repository.
3. Select the Components, such as old Oracle Grid Infrastructure or Oracle Database clone files that you want to clean up from the repository, and the Patch Version, for example, an older release of Oracle Database Appliance.
4. Click **Cleanup Clone Files** to clean up clone files for selected components from the repository at `/opt/oracle/oak/pkgrepos/orapkgs/clones/`.
5. Click **Cleanup Repository** to submit the cleanup repository job.
6. Click **Activity** to monitor the progress. When the job completes successfully, the Patch Repository is updated.

Related Topics

- [odacli cleanup-patchrepo](#)
Use the `odacli cleanup-patchrepo` command to delete obsolete or old patches from the repository.

About Upgrading to a Different Database Home

Understand how to upgrade to a different database home using either the Browser User Interface or `odacli` commands.

Prerequisites for Upgrading Database Homes

You can upgrade database homes of the following releases:

- Oracle Database 18c to 19c
- Oracle Database 12.2 to 19c
- Oracle Database 12.1 to 19c
- Oracle Database 11.2.0.4 to 19c
- Oracle Database 12.2 to 18c
- Oracle Database 12.1 to 18c
- Oracle Database 11.2.0.4 to 18c

- Oracle Database 12.1 to 12.2
- Oracle Database 11.2.0.4 to 12.2
- Oracle Database 11.2.0.4 to 12.1

Before upgrading to a different database home, upload the Oracle RDBMS Clone Files for the database version, to the repository, and then create the database home. See *Patching Oracle Database Appliance Using the CLI* for the procedure to update the repository with the latest Oracle RDBMS Clone Files.

About Upgrading Database Homes Using the Browser User Interface

Follow these steps to upgrade to a different database home using the Browser User Interface.

1. Log into the Browser User Interface with the `oda-admin` user name and password.

```
https://Node0-host-ip-address:7093/mgmt/index.html
```

2. Click the **Database** tab, and then select a database, click **Actions**, and then click **Upgrade**.
3. Verify that the database upgrade job completes successfully.

About Upgrading Database Homes Using the Command-Line Interface

Run the following command to upgrade to a different database home using the CLI:

```
odacli upgrade-database -i Comma separated list of database ids -from  
source dbhome id -to destination dbhome id [-j] [-h]
```

For more information about the options for the `upgrade-database` command, see the chapter *Oracle Database Appliance Command-Line Interface*.

Related Topics

- [odacli upgrade-database](#)
You can the `odacli upgrade-database` command to upgrade a database from a supported release. This command is deprecated and will be desupported in a future release. Instead, use the command `odacli move-database` to move databases from one Oracle Database home to another.

7

Re-imaging Oracle Database Appliance

Bare metal operating system re-imaging installs Oracle Database Appliance operating system software on the local (boot) drive.

Bare Metal is a non-virtualized Oracle Database Appliance configuration. Oracle Database Appliance ships from the factory with a bare metal configuration, default ISO image and Appliance Manager installed. Use the OS ISO Image to restore the OS to the "shipped from factory" state. Use only when necessary. Reimaging does not patch the firmware or update the component versions; it only re-images the local system disk from an operating system perspective. After imaging is completed, redeploy the End User image, then restore from backup, as needed.

- [Uninstalling Oracle Database Appliance Components](#)
Use the Oracle Database Appliance cleanup deploy utility, `/opt/oracle/oak/onecmd/cleanup.pl` to uninstall Oracle Database Appliance components.
- [Restoring an Oracle Database Appliance Baremetal System](#)
Re-image Oracle Database Appliance to perform a bare metal restore of Oracle Database Appliance.
- [Performing Secure Erase of Data on Storage Disks](#)
With this release, you can securely erase data from storage devices. Running the secure erase tool deletes the data on the storage disk permanently.

Related Topics

- [Errors when re-imaging Oracle Database Appliance](#)
Understand how to troubleshoot errors that occur when re-imaging Oracle Database Appliance.

Uninstalling Oracle Database Appliance Components

Use the Oracle Database Appliance cleanup deploy utility, `/opt/oracle/oak/onecmd/cleanup.pl` to uninstall Oracle Database Appliance components.

About the Cleanup Utility

Use the cleanup deploy utility to do the following:

- Uninstall Oracle Auto Service Request (Oracle ASR)
- Uninstall Oracle Trace File Analyzer (TFA)
- Uninstall Oracle ORAchk Health Check Tool
- Uninstall Oracle Grid Infrastructure and the Oracle stack
- Reset or delete the Oracle Linux udev rules
- Delete users and groups that were created when the appliance was created.

The script removes the firstnet config and the client access VLAN UNIX_DB, but does not delete any other VLANs. The script also resets any disabled CPU cores and enables all of the cores.

The cleanup utility runs in two modes: default and force mode. In the default mode, the commands used as part of cleanup do not use the force option. The Oracle ASM disk status is changed from MEMBER to FORMER, but ASM header on the disk is not erased. The default mode can be used only for cleaning up or re-provisioning of the same system.



Note:

For High-Availability systems, run the cleanup utility on both nodes sequentially. Ensure that the cleanup utility has completed on the first node, and then start the process on the second node.

Running the Cleanup Utility for a Baremetal Deployment

```
# perl /opt/oracle/oak/onecmd/cleanup.pl [-griduser grid_user] [-dbuser
db_user] [-groups comma separated list of groups] [-idmusers
dbuser1,dbuser2,dbuser3][-erasedata] [f]
```

When the *grid_user* and *db_user* are the same (*roleSeparation=false*), you must run the script for each user (*-gridUser* and *-dbUser*).

For example:

```
cleanup.pl -griduser oracle -dbuser oracle -idmusers
dbuser1,dbuser2,dbuser3
```

Table 7-1 Command Options for Cleanup Utility

Option	Description
<i>grid_user</i>	Describes the Oracle Grid Infrastructure user name. The default user is <i>grid</i> .
<i>db_user</i>	Describes the database user name. The default user is <i>oracle</i> Example with <i>grid</i> and <i>oracle</i> users: <pre>cleanup.pl -griduser oracle - dbuser oracle</pre>
<i>groups</i>	Describes the comma-separated list of groups. The default groups are <i>oinstall,dba,asmadmin,asmoper,asmdba</i> .
<i>idmusers</i>	Describes the comma-separated list of IdM users.

Table 7-1 (Cont.) Command Options for Cleanup Utility

Option	Description
erasedata	<p>Completely erases all disks on the Oracle Database system. It is mandatory to run this option if intention of cleanup is to reuse or move these disks on other systems. This option needs to be run on the first node when running on high-availability systems.</p> <p>Example of secure erase:</p> <pre>cleanup.pl -erasedata</pre>
cleanDefNet checkHeader	<p>Cleans up the default public network.</p> <p>Checks for OAK/ASM header on disks after successfully running the cleanup script. Use this to validate if the OAK/ASM header was erased by the cleanup script or not.</p> <p>Example of checking disk header:</p> <pre>cleanup.pl -checkHeader</pre>
f	<p>In the force mode, all commands use the force option. The ASM disk header is erased. The oakd header on the disk is erased in both default and force modes.</p> <p>Example of default mode:</p> <pre>cleanup.pl</pre> <p>Example of force mode:</p> <pre>cleanup.pl -f</pre>

 **Note:**

The cleanup utility for bare metal deployments produces a log file. The utility tries to create the log file at `/opt/oracle/oak/log/hostname/cleanup/cleanup_timestamp.log`. If the log cannot be created in that location, then the log is created at `/tmp/cleanup_timestamp.log`.

Restoring an Oracle Database Appliance Baremetal System

Re-image Oracle Database Appliance to perform a bare metal restore of Oracle Database Appliance.

Bare metal restore uses Oracle Integrated Lights Out Manager (Oracle ILOM) to re-image the Oracle Database Appliance node. The ILOM must be configured before performing a bare metal restore or re-image. Generally, the ILOM is configured as part of readying for deploying Oracle Database Appliance.

Download the Oracle Database Appliance Bare Metal ISO image to your local machine before you launch the Oracle ILOM console.

Follow these steps to re-image your appliance. For Oracle Database Appliance High-Availability deployment, follow these steps on **both** nodes.

1. Open a browser and connect to Oracle Integrated Lights Out Manager (ILOM) on Node 0 as root.
`https://ilom-ip-address`
2. Launch the Remote Console.
 - a. Expand **Remote Control** in the left navigation.
 - b. Click the **Redirection** tab.
 - c. Click **Launch** for the Remote Console in the Actions menu.
The state of the system determines what appears on the Console page.
3. Add the image.
 - a. Click the **KVMS** tab, then select **Storage**.
 - b. Click **Add**.
 - c. Browse to the Oracle Database Appliance Bare Metal ISO Image, highlight the image, then click **Select**.
 - d. Click **Connect**.
The mounting of the ISO image is successful when the **Connect** button changes to a **Disconnect** button.
 - e. Click **OK**
The CD-ROM icon in the top right corner is highlighted.
4. Configure the CD-ROM as the next boot device.
 - a. Expand **Host Management** in the left menu of the ILOM Remote Console tab.
 - b. Click **Host Control**.
 - c. Select **CDROM** from the Next Boot Device menu, then click **Save**.
5. Power cycle the node.
 - a. Click **Power Control** in the **Host Management** menu.
 - b. Select **Power Cycle** , then click **Save**.

When the node comes back after the power cycle, re-imaging starts automatically. The Oracle Linux page appears, followed by the Running Post-Install scripts page.

The Running Post-Install scripts page is a static page and might give the impression that the re-imaging process is not progressing. The post-install process during re-imaging will wait until the synchronization between the partitions of the two mirrored local hard disks is complete, which can take 15 to 20 minutes to complete.

To check the progress of re-synchronization, press the ALT-F2 key combination to open a second console and enter the following command:

```
# cat /proc/mdstat
```

When the re-synchronization is complete, re-imaging is completed and the machine restarts.

After the machine restarts, the system is ready for you to deploy the Oracle software on the appliance to create an Oracle Database Appliance bare metal platform.

Performing Secure Erase of Data on Storage Disks

With this release, you can securely erase data from storage devices. Running the secure erase tool deletes the data on the storage disk permanently.

You may want to consolidate storage disks between appliances. For example, you can use X7-2 disks on X6-2 models, and may want to consolidate all X6-2 disks on one system, and use all new X7-2 storage disks on another system. In such cases, use secure erase to erase headers from disks before re-imaging the disks, since the storage disks across the appliances may have different partition ratios.

Note:

Running the secure erase tool removes data from storage disks permanently. If you have any data on the disk, then take a backup of your storage disk before running the secure erase tool.

Follow the steps to run the secure erase tool:

1. Stop `oakd` and the database and Oracle Grid Infrastructure before running the secure erase tool.

On bare metal systems, run the command:

```
# odaadmcli stop oak
```

On Virtualized Platforms:

```
# oakcli stop oak
```

To stop Oracle Clusterware resources:

```
# crsctl stop crs -f
```

2. Run the secure erase tool:

```
# /opt/oracle/oak/bin/odaeraser.py
```

3. You can also run the secure erase tool when running the cleanup tool:

```
# /opt/oracle/oak/onecmd/cleanup.pl -erasedata
```

Example 7-1 Options for the Secure Erase Tool

Option	Description
-a, --all	Erases all disks. For example: # /opt/oracle/oak/bin/odaeraser.py --all
--disk <i>disk1,disk2</i>	Erases specified disks. For example: # /opt/oracle/oak/bin/odaeraser.py --disk e0_pd_00,e0_pd_01
--dryrun	Runs the tool in the test mode
--type HDD SSD NVMe	Erases the type of disk specified
-v, --verbose	Displays verbose output
-h, --help	Displays all CLI options for the tool

8

Managing Oracle Databases

Manage the Oracle Databases on your Oracle Database Appliance.

- [About Administrative Groups and Users on Oracle Database Appliance](#)
Oracle Database Appliance Browser User Interface deployment creates operating system groups and users whose members are granted system administration privileges on the appliance.
- [About Data Migration Options for Oracle Database Appliance](#)
Oracle Database Appliance supports the use of standard Oracle Database loading and migration tools.
- [About Standard Edition High Availability for Oracle Database Appliance](#)
Oracle Database Appliance supports Standard Edition High Availability solution with Oracle Grid Infrastructure that provides cluster-based failover for Oracle Database 19c Standard Edition.
- [About Transparent Database Encryption \(TDE\) in Oracle Database Appliance](#)
Transparent Data Encryption (TDE) enables you to encrypt sensitive data that you store in tables and tablespaces.
- [Working with Databases](#)
Use the Browser User Interface to display a list of databases, database details, and create and delete databases. You can use CLI commands to manage your databases.
- [Working with Database Homes](#)
Use the Browser User Interface to display a list of database homes, details, and create and delete database homes.
- [Migrating Databases](#)
Review these topics to learn how to prepare for and migrate an entire database to your Oracle Database Appliance.
- [About Managing Multiple Database Instances Using Instance Caging](#)
Use instance caging to manage your system resources on Oracle Database Appliance.
- [Oracle EM Express and DB Console](#)
You can use Oracle Enterprise Manager Database Express (EM Express), or the Database Control Console (DB Console) to manage your database.

About Administrative Groups and Users on Oracle Database Appliance

Oracle Database Appliance Browser User Interface deployment creates operating system groups and users whose members are granted system administration privileges on the appliance.

During configuration, two administrative accounts are created for Oracle Database Appliance: the user `grid`, with a user ID (UID) of 1001, and the user `oracle`, with a

UID of 1000. The user `grid` is the Oracle Grid Infrastructure installation owner. The user `oracle` is the Oracle Database installation owner, and the owner of all Oracle Database homes (Oracle homes). By default, these users are members of operating system groups whose members are granted privileges to start up and administer Oracle Database and Oracle Automatic Storage Management.

The following table describes the Oracle system privileges groups, and information about the operating system authentication groups:

Table 8-1 Operating System Groups and Users on Oracle Database Appliance

Oracle System Privileges	Group Name	Group ID (GID)	<i>grid</i> is a member	<i>oracle</i> is a member
Oracle Inventory group (OINSTALL)	<code>oinstall</code>	1001	yes (primary group)	yes (primary group)
OSOPER for dbaoper group	<code>dbaoper</code>	1002	yes	yes
OSDBA group	<code>dba</code>	1003	no	yes
OSASM group for Oracle ASM	<code>asmadmin</code>	1004	yes	no
OSOPER for ASM group	<code>asmoper</code>	1005	yes	no
OSDBA for ASM group	<code>asmdba</code>	1006	yes	yes

To change the Group Name and GID from the default values on Oracle Database Appliance bare metal platforms, change the default values from the Browser User Interface during the deployment. If you create an initial database during deployment, then the password for the SYS and SYSTEM users is the password that you set in the Browser User Interface.

To change the Group Name and GID from the default values on the Oracle Database Appliance Virtualized Platform, use the `-advance` parameter with the command `oakcli deploy`. If you create an initial database during deployment, then the password for the SYS and SYSTEM users is the ROOT password from the Configurator.



Note:

Change the password for both users as soon as possible after configuration to prevent unauthorized access to your database using these privileged accounts.

About Data Migration Options for Oracle Database Appliance

Oracle Database Appliance supports the use of standard Oracle Database loading and migration tools.

If you are loading data or migrating data from an existing database to Oracle Database Appliance, then you can use the standard Oracle Database loading and migration tools. These tools include the following:

- Oracle GoldenGate
- SQL*Loader
- Oracle Data Pump
- transportable tablespaces
- RMAN

You can also use the RMAN utility to back up and recover databases on Oracle Database Appliance.

About Standard Edition High Availability for Oracle Database Appliance

Oracle Database Appliance supports Standard Edition High Availability solution with Oracle Grid Infrastructure that provides cluster-based failover for Oracle Database 19c Standard Edition.

About Standard Edition High Availability for Oracle Database 19c

With Standard Edition High Availability, when there is an instance or a node failure, the database automatically fails over to the other node, after attempting to restart on the local node. The database is restarted on the surviving node, thereby providing high availability for Oracle Standard Edition databases.

If your Oracle Database deployment contains Standard Edition 2 Oracle Real Application Cluster (Oracle RAC) databases of releases earlier than 19c, then they must be converted to a Standard Edition High Availability configuration as part of the upgrade to Oracle Database 19c.

For more details about this feature, refer to the Oracle Database Documentation Library at <https://docs.oracle.com/en/database/oracle/oracle-database/index.html>.

About Standard Edition High Availability for Oracle Database Appliance Release 19.10

Standard Edition High Availability for Oracle Database 19c is supported on Oracle Database Appliance for high availability deployments, that is, deployments that have two server nodes, shared storage, and server interconnects.

Oracle Database Appliance enables automatic configuration for failover at deployment time for Oracle Database 19c Standard Edition single-instance databases. Both nodes have Oracle Homes for Standard Edition single-instance databases.

Single-instance Oracle Database 19c Standard Edition databases created using the ODA CLI commands or the Browser User Interface (BUI) have Standard Edition High Availability enabled by default. You can also choose to disable the High Availability option. To enable Standard Edition High Availability for existing Standard Edition Oracle RAC databases of releases earlier than 19c, you must convert these Oracle RAC databases to single-instance databases, and then upgrade to single-instance Oracle Database 19c Standard Edition database with Standard Edition High Availability enabled by default.

About Provisioning, Upgrading, and Relocating Standard Edition High Availability Oracle Database

To create a single-instance Oracle Database 19c with Standard Edition High Availability, use the following command:

```
odacli create-database -u db_unique_name -n db_name -dh db_home -y SI  
-g target_node
```

To upgrade a Standard Edition Oracle RAC Database to Oracle Database 19c Standard Edition, convert the Oracle RAC Database to a single-instance Oracle Database:

```
odacli modify-database -in db_name -y single-instance
```

Then, upgrade the single-instance database to Oracle Database 19c with Standard Edition High Availability as follows:

```
odacli upgrade-database -i db_id -to destination_dbhome -sh
```

To relocate a Standard Edition High Availability Oracle Database from one node to another outside of a failover, use the following command:

```
odacli modify-database -in db_name -g target_node | -th target_host
```

For detailed information about these ODA CLI command options, see the *Oracle Database Appliance Command Line Reference* chapter in this guide.

Related Topics

- [Oracle Database Appliance Command-Line Interface](#)
The command-line interface has different classes of tools to manage Oracle Database Appliance.

About Transparent Database Encryption (TDE) in Oracle Database Appliance

Transparent Data Encryption (TDE) enables you to encrypt sensitive data that you store in tables and tablespaces.

After the data is encrypted, this data is transparently decrypted for authorized users or applications when they access this data. TDE helps protect data stored on media (also called data at rest) in the event that the storage media or data file is stolen.

Oracle Database uses authentication, authorization, and auditing mechanisms to secure data in the database, but not in the operating system data files where data is stored. To protect these data files, Oracle Database provides Transparent Data Encryption (TDE).

TDE encrypts sensitive data stored in data files. To prevent unauthorized decryption, TDE stores the encryption keys in a security module external to the database, called a keystore.

Oracle Database Appliance provides the option to create TDE-enabled databases, backup, recover, and restore TDE-enabled databases, backup and restore TDE wallet, re-keying of TDE master encryption key, and changing the password of password-protected Keystore.

 **Note:**

To enable Transparent Data Encryption (TDE), you must deploy Enterprise Edition Oracle Database 18c or later.

 **See Also:**

[Using Transparent Data Encryption](#) in the *Oracle Database Advanced Security Guide*

 **Caution:**

When you enable TDE, you are prompted to set a password for the TDE wallet. Provide a strong password for security compliance. Set the password carefully, and ensure that this password is available to you at all times for database management operations. Failure to provide the TDE wallet password when prompted, will cause an error in accessing encrypted data.

Working with Databases

Use the Browser User Interface to display a list of databases, database details, and create and delete databases. You can use CLI commands to manage your databases.

 **Note:**

Oracle Database Appliance enables unified auditing for databases created in new database homes. Unified audit trail captures audit information and places them in one location and in one format. This consolidated view enables auditors to co-relate audit information from different components. Having a single audit trail also improves management and security of the audit trail. For more information about unified audit trail for Oracle Database, see *Oracle Database Security Guide*.

- [Viewing Databases](#)
Use the Oracle Appliance Manager Browser User Interface to display a list of Oracle databases and database details, create, upgrade, and delete a database in Oracle Database Appliance.
- [Creating a Database Using the Browser User Interface](#)
Use the Oracle Appliance Manager Browser User Interface to create a database in Oracle Database Appliance.

- [Creating a Database Using ODA CLI Commands](#)
Create a database from the command-line interface.
- [Cloning a Database from Backup](#)
Use the Browser User Interface to clone a database from a backup.
- [Cloning an Oracle ACFS Database Using the Browser User Interface](#)
Create a database from an existing Oracle ACFS database using the Browser User Interface.
- [Cloning an Oracle ACFS Database Using Command Line Interface](#)
Create a database from an existing Oracle ACFS database using CLI commands.
- [Modifying a Database](#)
Use the Oracle Appliance Manager Browser User Interface or ODA CLI commands to modify a database in Oracle Database Appliance.
- [Moving a Database from One Oracle Home to Another](#)
Use the Oracle Appliance Manager Browser User Interface or ODA CLI commands to move a database from one Oracle home to another of the same database version.
- [Upgrading a Database](#)
Use the Oracle Appliance Manager Browser User Interface to upgrade an Oracle database to a different database home version.
- [Deleting a Database](#)
Use the Oracle Appliance Manager Browser User Interface to delete an Oracle database.

Viewing Databases

Use the Oracle Appliance Manager Browser User Interface to display a list of Oracle databases and database details, create, upgrade, and delete a database in Oracle Database Appliance.

On the Oracle Database Appliance Virtualized Platform, see the command `oakcli list databases`.

1. Log into the Browser User Interface:

```
https://host name or ip-address:7093/mgmt/index.html
```

2. Click the **Database** tab.

The screenshot shows the Oracle Database Appliance Manager interface. The top navigation bar includes 'Appliance', 'Database', 'Object Store', 'Monitoring', and 'Activity'. The 'Database' section is active, showing a list of databases. The table below contains the following data:

Database Name	ID	Created	CDB	DB Version	Shape	Storage	Actions
clonedb	19b58021-5726-4029-83c9-9530dc720b96	Fri Oct 05 2018 9:37:06 AM	true	18.3.0.0.180717	odb1s	ACFS	Actions
testdb18	4c0c1240-be0d-495b-b665-c2340297e721	Fri Oct 05 2018 9:25:23 AM	false	18.3.0.0.180717	odb4	ASM	Actions
cdbscfs	58efc217-8bad-415e-afdd-0aeacc3f755	Tue Oct 02 2018 7:46:36 AM	true	18.3.0.0.180717	odb1s	ACFS	Actions
cdb18asm	1d123775-d0c0-4379-9597-6826f2baf076	Tue Oct 02 2018 7:11:33 AM	true	18.3.0.0.180717	odb1	ASM	Actions
testdb	ca0ca63e-49d5-4797-a845-af433ab0f79c	Tue Oct 02 2018 6:17:53 AM	true	18.3.0.0.180717	odb4	ASM	Actions

Copyright © 2011, 2018 Oracle and/or its affiliates. All rights reserved.

- (Optional) Click the database name, in blue font, to display more details about the database.
- (Optional) Click **Actions** next to a database entry to view more details, upgrade or delete the database.

Creating a Database Using the Browser User Interface

Use the Oracle Appliance Manager Browser User Interface to create a database in Oracle Database Appliance.

Ensure that the repository is updated with Oracle RDBMS Clone files for a database version, before creating the database as described in *Updating Oracle Database Appliance Repository with Database Clone Files Using the CLI*.

Note:

For Standard Edition Oracle Database 19c or later, you cannot create Oracle RAC or Oracle RAC One Node Database. You can only create single-instance Oracle Database. For Standard Edition Oracle Database 19.6 or later, you can choose to enable high availability for single-instance database.

The Browser User Interface provides a quick and easy method of creating new databases. The Create New Database page in the Browser User Interface is populated with default options for most of the configuration options. Drop-down lists enable you to quickly view and select from a list of available options. You can use the drop-down list to create a new database Oracle Database Home (ORACLE_HOME) for the database or select an existing ORACLE_HOME that you created earlier.

Oracle Database 19.10 is supported on both Oracle Automatic Storage Management (Oracle ASM) and Oracle ASM Cluster file system (Oracle ACFS). When databases are created in Oracle ACFS, each database is configured with its own Oracle ACFS file system for the datafiles and uses the following naming convention: `/u02/app/db user/oradata/db unique name`. The default size of this mount point is 100 GB.

The fields in the Browser User Interface adjust, depending on the database version you select.

Follow these steps to create a database:

1. Log into the Browser User Interface:

`https://host-ip-address:7093/mgmt/index.html`

2. Click the **Database** tab.
3. Click **Create Database** to display the Create Database page.
4. Select **Create Database** on the Create Database page.
5. Enter the following information on the Create Database page to configure the database:

- a. In the **DB Name** field, enter a name for the database. The name *db1* appears in the field as an example of a database name, but the field is not populated. You must enter a name.

The name must contain lowercase alphanumeric characters and cannot exceed 8 characters. The Oracle system identifier (SID) is always set to the database name.

- b. (Optional) In the **DB Unique Name** field, enter a name to define a unique name for the database.
- c. In the **Use Existing DB Home** field, select **Yes** or **No**.
- d. In the **DB Version** field, select a database bundle patch number from the drop-down list.

Available database versions with available clones appear in the list in descending order. Supported versions that are not available in the repository appear in light gray font at the bottom of the list. Search is available for the list. To add a supported version to the repository, download the RDBMS clone file and update the repository.

- e. For the **CDB** option on Oracle Database releases later than 12.1, select **Yes** or **No**, depending on whether or not you want the database to be a container database (CDB). The default is **Yes**.
- f. In the **PDB Name** field, enter a name for the pluggable database (PDB).

Alphanumeric characters and underscore (`_`) are valid. The name must begin with an alphanumeric character and cannot exceed 30 characters. The name *pdb1* appears in the field in italic text as an example, but it is not populated. You must enter a name.

- g. In the **PDB Admin User** field, enter a name.

The field shows *pdadmin* as an example, you must enter a name. Alphanumeric characters and underscore (`_`) are valid.

- h. In the Database Edition field, enter the edition for which you have a license, either **Enterprise Edition** or **Standard Edition**.

For Standard Edition Oracle Database 19c or later, you can only create single-instance Oracle Database. For Standard Edition Oracle Database 19.6 or later, you can choose to enable high availability for single-instance database.

- i. For single-instance Oracle Database deployment, specify the **Node**, either Node0 or Node1. The default is Node0. Specify whether you want to **Enable High Availability**.

- j. In the **Shape** field, select a database shape from the drop-down list. The shape determines the number of cores and total memory allocated to the database. The default is `odb1`.
 - k. In the **Database Class** field, select a database class from the drop-down list. If an option is not available in the list, it is not supported for the database edition on the Oracle Database Appliance or the version that you selected. The default is OLTP.
 - l. In the **Storage** field, select **ACFS** or **ASM** from the drop-down list. The default is Oracle ASM.
 - m. If the disk group redundancy was set to **Flex** during the appliance creation, then you can select the **Database Redundancy** value as **Mirror** or **High**.
 - n. Select the **Networks** you want to associate with the database.
 - o. For the **Configure EM Express** or **Configure EM Console** option, select **Yes** or **No**. The default is **No**.

Select **Yes** to configure the Oracle Enterprise Manager Database Express (EM Express) console for Oracle Database 19.10. Selecting **Yes** enables you to use the console to manage the database.
 - p. In the **SYS and PDB Admin User Password** field, enter the password for the SYS, SYSTEM, and PDB Admin.

The password must begin with an alpha character and cannot exceed 30 characters. Quotation marks are not allowed.
 - q. In the **Confirm Password** field, enter the password again to confirm.
 - r. In the **Characteraset** field, select an option from the drop-down list. The default is AL32UTF8.
 - s. In the **National Characteraset** field, select an option from the drop-down list. The default is AL16UTF16.
 - t. In the **Language** field, select a database language from the drop-down list. The default is American.
 - u. In the **Territory** field, select a territory or location for the database from the drop-down list. The default is America.
 - v. For Oracle Database Enterprise Edition 18c or later, you can choose to enable Transparent Database Encryption (TDE). Select **Yes** or **No** in the **Enable TDE** option. Specify and confirm the **TDE Password**. By default, the TDE option is disabled.
6. Click **Create**. When prompted, click **Yes** to confirm that you want to start the job to create the database.

The job is submitted and a confirmation page appears with a link to the job. Click the link to view the job progress, tasks, and status.

After you close the Job confirmation page, you can click the **Activity** tab to monitor the job progress. Click the job number to view the tasks and status details. Click **Refresh** to refresh the page.

Creating a Database Using ODACLI Commands

Create a database from the command-line interface.

Note:

If you provisioned the appliance without creating an initial database, then you must create a Oracle home. If the version of the database home is different from the migrated database, create a database home for the migrated database. You might want to create a database home specifically for the migrated database.

Caution:

When you create a database with Transparent Data Encryption (TDE) enabled, you are prompted to set a password for the TDE wallet. Provide a strong password for security compliance. Enter this password carefully when setting it for the first time, and ensure that this password is available to you at all times for database management operations. Failure to provide the TDE wallet password when prompted, will cause an error in accessing encrypted data.

This example creates a new database named `PRODDB` with database version 19.10, and a new database home, if a database home does not exist.

1. Use the `odacli list-dbhomes` command to display a list of database homes and verify that a database home exists for the database version.

Note the ID if you want to use an existing database home or if you want to get more details. Use the `odacli describe-dbhomes` command to get more details about a specific database home.

```
# odacli list-dbhomes
ID                               Name                               DB Version
-----
b727bf80-c99e-4846-ac1f-28a81a725df6 OraDB199_home1 19.10.0.0.0

(continued)
Home Location
-----
/u01/app/orauser/product/19.0.0.0/dbhome_1
```

2. Create a database home if a database home does not exist for the database version.

If you want to create a database home specifically for the migrated database, you can use the `odacli create-dbhome` command, or you can create the

database home when you create the database. The example creates a database home for database version 19.10.0.0.0.

```
# odacli create-dbhome -v 19.10.0.0.0
```

3. Create a database. You can use an existing database home ID or you can create a database home when creating the database.

To create a database named `PRODDB` that uses an existing database home with ID `b727bf80-c99e-4846-ac1f-28a81a725df6`:

```
# odacli create-database -n PRODDB -io -dh b727bf80-c99e-4846-ac1f-28a81a725df6
```

To create a database named `PRODDB` with database version `19.10.0.0.0` and a database home:

```
# odacli create-database -n PRODDB -v 19.10.0.0.0 -io
```

To create a TDE-enabled database named `PRODDB`:

```
# odacli create-database -n PRODDB -t
```

Cloning a Database from Backup

Use the Browser User Interface to clone a database from a backup.

When you backup a database in Oracle Database Appliance, a backup report is created. Save the backup report as a JSON file and you can use the file to create a database on the same appliance, or a different appliance.

The following are the prerequisites to cloning a database from a backup:

1. The source database backup location must be Object Store or External FRA (Network File System).
2. If you use Object Store backup location, then obtain Object Store Credentials for the host.
3. If you use an External FRA (Network File System) backup location, then obtain the Network File System (NFS) mount point location.
4. Create a backup policy using the object store credentials or NFS mount point as the backup destination.
5. Attach the backup policy to the database that you want to backup. If the source database does not have TDE enabled, then providing the Backup Encryption password is mandatory when attaching Objectstore backup policy. However, the Backup Encryption password is optional when attaching the NFS backup policy. If the source database has TDE enabled, then you must specify the TDE password, and not the Backup Encryption password.
6. Create a manual backup of the database and save the backup report generated when the backup completes.

Follow these steps to create a database from backup:

1. Log into the Browser User Interface:

```
https://host-ip-address:7093/mgmt/index.html
```

2. Click the **Database** tab.
3. Click **Create Database** to display the Create Database page.
4. Click **Clone Database from Backup**, then click **Next** to display the Clone Database from Backup page.
5. Select the Backup Destination from which you want to create the database. If your backup destination is ObjectStore:
 - a. Select Backup Destination as **ObjectStore**.
 - b. Select your **Object Store Credential Name**.
 - c. Enter the password in the **Backup Encryption Passwords** field and the **Confirm Backup Encryption Passwords** field.

If your backup destination is Network File System (NFS):

- a. Select Backup Destination as **External FRA**.
 - b. Enter the password in the **Backup Encryption Passwords** field and the **Confirm Backup Encryption Passwords** field.
6. Click **Browse** and select the backup report from which you want to create the database.

When the backup report is loaded, additional fields appear on the page and are populated based on the backup report. You can edit some of the fields.

For Standard Edition Oracle Database 19c or later, you cannot clone Oracle RAC or Oracle RAC One Node Database. You can only clone a single-instance Oracle Database. For Standard Edition Oracle Database 19.6 or later, you can choose to enable high-availability for single-instance database.

7. In the **DB Name** field, enter a name for the database.

The name must contain lowercase alphanumeric characters and cannot exceed 8 characters. The Oracle system identifier (SID) is always set to the database name.
8. Enter the password in the **SYS and PDB Admin User Password** field and the **Confirm Password** field.
9. Specify the Networks.
10. If your source database has Transparent Database Encryption (TDE) enabled, then you can enable TDE on the cloned database. If the source database has TDE enabled, then the backup report has the TDE wallet backup location and the **TDE Wallet Backup Location** field in the BUI displays this value. Specify and confirm the **TDE Password**.
11. Click **Create**.
12. Click **Yes** to confirm that you want to clone a database from the selected Object Store or External FRA.

When you submit the job, the job ID and a link to the job appears. Click the link to display the job status and details.

13. Validate that the job completed. You can track the job in the **Activity** tab in the Browser User Interface, or run the command `odacli describe-job` with the job ID.

```
# odacli describe-job -i jobId
```

Cloning an Oracle ACFS Database Using the Browser User Interface

Create a database from an existing Oracle ACFS database using the Browser User Interface.

Cloning enables to:

- Create a database from another database without bringing down the source database
- Create multiple databases from a gold image, thus ensuring standardized mass deployments
- Optimize space utilization, by use of Oracle ACFS snapshots in cloning
- Create different types of databases, from a single source database type. For example, you can create single-instance databases, Oracle RAC databases, or Oracle RAC One Node databases from any type of source database
- Depending on the available memory and CPU cores, specify a supported database shape such as `odb1s`, `odb2`, and so on, to create any class of database from any source database.

 **Note:**

Cloning a Transparent Database Encryption (TDE) enabled database is not supported.

Follow these steps to create a database from an existing Oracle ACFS database:

1. Log into the Browser User Interface:

```
https://host-ip-address:7093/mgmt/index.html
```

2. Click the **Database** tab.
3. Click **Create Database** to display the Create Database page.
4. Click **Clone a Database**, then click **Next** to display the Clone Database page.
5. Select the **Source Database** from which you want to create the database.

For Oracle Database 19c Standard Edition, you can only create single-instance Oracle Database, with or without high-availability.

6. Select the **Database Shape** (template) for your new database. The database shape you select determines the total memory allocated to the database.
7. In the **DB Name** field, enter a name for the database.
The name must contain lowercase alphanumeric characters and cannot exceed 8 characters. The Oracle system identifier (SID) is always set to the database name.
8. Specify the **DB Unique Name** for the database. If the database unique name is not provided, then the name of the database is set to the database name.
9. Specify the Networks.
10. Enter the password in the **SYS and PDB Admin User Password** field and the **Confirm Password** field.

11. Click **Create**.
12. Click **Yes** to confirm that you want to clone a database from the selected source database.

When you submit the job, the job ID and a link to the job appears. Click the link to display the job status and details.
13. Validate that the job completed. You can track the job in the **Activity** tab in the Browser User Interface, or run the command `odacli describe-job` with the job ID.

```
# odacli describe-job -i jobId
```

Cloning an Oracle ACFS Database Using Command Line Interface

Create a database from an existing Oracle ACFS database using CLI commands.

Cloning enables to:

- Create a database from another database without bringing down the source database
- Create multiple databases from a gold image, thus ensuring standardized mass deployments
- Optimize space utilization, by use of Oracle ACFS snapshots in cloning
- Create different types of databases, from a single source database type. For example, you can create single-instance databases, Oracle RAC databases, or Oracle RAC One Node databases from any type of source database
- Depending on the available memory and CPU cores, specify a supported database shape such as `odb1s`, `odb2`, and so on, to create any class of database from any source database.
- The ability to create clone databases on a standby system enables you to set up test or development environments based on your standby databases. Since standby systems are not production systems, they are a better choice for seeding test or development environments.

Following are the prerequisites to clone a database:

- Ensure that Oracle Clusterware is running on all nodes, and the source database is up and running.
- The source database must use Oracle ACFS storage.
- The source database must not be a multitenant container databases (CDBs)
- The source database must be in the OPEN state.
- The source database must not be in backup mode.
- The source database must be in archive mode.
- The source database must not have Transparent Database Encryption (TDE) enabled.

 **Note:**

For Standard Edition Oracle Database 19c or later, you cannot clone Oracle RAC or Oracle RAC One Node Database. You can only clone a single-instance Oracle Database. For Standard Edition Oracle Database 19.6 or later, you can choose to enable high-availability for single-instance database.

Follow this procedure to clone a database:

- Run the `odacli clone-database` command.

```
odacli clone-database --databaseUniqueName --dbname --dbshape --  
dbtype |SI --json --sourcedbname
```

Specify the unique name of the database, the name for the new database, the database shape, the type of database, and the source database name. For information about all the command options, see the *ODACLI Command Reference* chapter.

Related Topics

- [odacli clone-database](#)
Use the `odacli clone-database` command to clone a new database from a source database.

Modifying a Database

Use the Oracle Appliance Manager Browser User Interface or ODACLI commands to modify a database in Oracle Database Appliance.

Modifying a Database Using the Browser User Interface

1. Log into the Browser User Interface:
`https://host-ip-address:7093/mgmt/index.html`
2. Click the **Database** tab.
3. For the database that you want to modify, select **Modify** in the Actions drop down list.
4. In the Modify Database page, you can attach or detach associated networks and backup policy, and modify database shape and class.
5. To modify the **Database Class** or **Database Shape**, select the new value in the drop down list.
6. To attach or detach networks, modify the values in the **Attach Networks** and **Detach Networks** fields.
7. To remove the associated backup policy from the database, do not select any value in the **Select Back up Policy** drop down list.
8. If you configured Oracle Flex disk group when you created the database, you can also modify the database redundancy. If the database you are modifying is an Oracle ACFS Database, then the database redundancy for all cloned Oracle ACFS databases is modified.

9. You can choose to change the **Backup Encryption Password**. If the database has TDE enabled, then the RMAN Backup Encryption password is not used.
10. Click **Modify**. When prompted, click **Yes** to confirm that you want to start the job to modify the database.

Modifying a Database Using ODACLI Commands

1. Use the `odacli modify-database` command to modify the configuration of a database, such as backup configuration, database class, database type, TDE key.

```
# odacli modify-database -s database_shape -cl database_class -i  
dbid
```

For example:

```
# odacli modify-database -i 1941d594-c777-4eca-9fce-18b778d5c153 -s  
odb2 -cl DSS
```

For example, the following command re-keys the TDE master encryption key of the database after accepting the current TDE Wallet password.

```
# odacli modify-database -in testdb -rkt  
Current password for TDE wallet:
```

For more information about the `odacli modify-database` command options, see the *Oracle Database Appliance Command Line Reference* chapter in this guide.

Related Topics

- [odacli modify-database](#)
Use the `odacli modify-database` command to modify the configuration of a database, such as backup configuration, database class, and database type.

Moving a Database from One Oracle Home to Another

Use the Oracle Appliance Manager Browser User Interface or ODACLI commands to move a database from one Oracle home to another of the same database version.

Moving a Database Using the Browser User Interface

1. Log into the Browser User Interface:
`https://host-ip-address:7093/mgmt/index.html`
2. Click the **Database** tab.
3. For the database that you want to modify, select **Move** in the Actions drop down list.
4. Select the Destination Database Home where you want to move the database. The destination database home must be of the same base version.
5. Click **Move**. When prompted, click **Yes** to confirm that you want to start the job to move the database.

Moving a Database Using ODACLI Commands

1. Use the `odacli move-database` command to move a database from one Oracle home to another home of the same database version.

```
# odacli move-database -i database_ID -dh  
destination_database_home_ID
```

For more information about the `odacli move-database` command options, see the *Oracle Database Appliance Command Line Reference* chapter in this guide.

Related Topics

- [odacli move-database](#)
Use the command `odacli move-database` to move a database from one Oracle home to another home of the same database version.

Upgrading a Database

Use the Oracle Appliance Manager Browser User Interface to upgrade an Oracle database to a different database home version.

Before upgrading to a different database home, you must upload the Oracle RDBMS clone files to the repository and create the database home.

Note:

You cannot upgrade Oracle RAC or Oracle RAC One Node Database to a destination database home of Standard Edition Oracle Database 19c or later. You must first convert Oracle RAC Or Oracle RAC One Node Database to single-instance Oracle Database using the `odacli modify-database` command and then upgrade the single-instance Oracle Database to a destination database home of Standard Edition 19c or later.

1. Log into the Browser User Interface:

```
https://host name or ip-address:7093/mgmt/index.html
```
2. Click the **Database** tab.
3. Click **Actions** next to the database that you want, then select **Upgrade**.
4. Select the destination database home version from the list of available versions, then click **Upgrade**.

When upgrading single-instance Standard Edition Oracle Database 18.9 or later to Standard Edition Oracle Database 19c or later, you can also choose to enable or disable High Availability.

Deleting a Database

Use the Oracle Appliance Manager Browser User Interface to delete an Oracle database.

1. Log into the Browser User Interface:
`https://host name or ip-address:7093/mgmt/index.html`
2. Click the **Database** tab.
3. Click **Actions** next to the database that you want, then select **Delete**.
4. Confirm the action.

Working with Database Homes

Use the Browser User Interface to display a list of database homes, details, and create and delete database homes.

- [About Managing Multiple Oracle Homes on Oracle Database Appliance](#)
Create and manage one or more Oracle home directories and Oracle databases on Oracle Database Appliance.
- [Viewing Database Homes](#)
Use the Browser User Interface to display a list of database homes and database home details, including databases associated with a DB home.
- [Creating a Database Home](#)
Use the Browser User Interface to create database homes in Oracle Database Appliance.
- [Deleting a Database Home](#)
Use the Browser User Interface to delete an Oracle database home.

About Managing Multiple Oracle Homes on Oracle Database Appliance

Create and manage one or more Oracle home directories and Oracle databases on Oracle Database Appliance.

Oracle home is the directory in which you install Oracle Database binaries, and from which Oracle Database runs. Oracle Database Appliance supports multiple Oracle homes, including support of different release Oracle Database homes. You can create multiple Oracle databases on a given Oracle home. Use Oracle Appliance Manager Browser User Interface to create and manage multiple Oracle homes and databases on Oracle Database Appliance. Oracle Database Appliance Manager automatically creates an Oracle Database Oracle home that is compliant with Oracle's Optimal Flexible Architecture (OFA) standards.

Check the *Oracle Database Appliance Release Notes* to obtain information about the specific Oracle software releases supported for your Oracle Database Appliance platform.

When you use ODA CLI commands to create multiple homes on Oracle Database Appliance, the commands start the Oracle Home cloning process. In Oracle Database Appliance deployments, the user `oracle` is the default software installation owner.

You can use the Browser User Interface or the command-line interface to create and manage databases.

Use ODA CLI commands to create, list, describe, and delete databases on Oracle Database Appliance. The `odacli create-database` command enables you to

create a database with minimal user input. When you run this command without any additional options, the command creates a new database home (ORACLE_HOME). You can create a database in an existing home by using the `--dbhomeid` option. To find the `dbhomeid`, use the `odacli list-dbhomes` command.

Alternatively, you can use the Browser User Interface to create list, describe and delete databases and database homes. You can display a list of all Database Homes that includes the database home name, ID, version, the date and time that the database home was created and the location on the same page. You can also create and delete database homes on the Browser User Interface.

▲ Caution:

Do not apply Oracle Database patches directly to Oracle Databases on Oracle Database Appliance. Only use Oracle Database Appliance patch bundles, which are tested to work across the whole software stack. If a one-off database patch is required, it may be applied to the Oracle Home. When you apply the Oracle Database Appliance patch bundle, it may cause a conflict during future patching events and you might need to roll back and then re-apply the patch.

Viewing Database Homes

Use the Browser User Interface to display a list of database homes and database home details, including databases associated with a DB home.

1. Log in to the Browser User Interface:
`https://ip-address:7093/mgmt/index.html`
2. Click the **Database** tab.
3. Click **Database Home** on the left menu to view all database homes. The name, ID, version, location and date and time stamp of when the database home was created appears on the page.
4. (Optional) Click **Actions** next to a database home entry, then **View Databases** to see the databases that are associated with the database home.

Creating a Database Home

Use the Browser User Interface to create database homes in Oracle Database Appliance.

Before you can create a database home, the Oracle Database Appliance RDBMS Clone file image must be in the repository. Follow these steps to create a database home:

1. Log in to the Browser User Interface:
`https://ip-address:7093/mgmt/index.html`
2. Click the **Database** tab, then click **Database Home**.
3. Click **Create Database Home**.

4. Select a database version from the list of available versions, then select the database edition, either **Enterprise Edition** or **Standard Edition**, per your licensing agreement.
5. Click **Create**. When prompted, click **Yes** to confirm that you want to start the job.

Deleting a Database Home

Use the Browser User Interface to delete an Oracle database home.

You can delete a database home (DB Home) if it is not associated with any databases.

1. Log into the Browser User Interface:

```
https://host name or ip-address:7093/mgmt/index.html
```
2. Click the **Database** tab.
3. Click **Database Home** on the left menu to view all database homes. The name, ID, version, location and date and time stamp of when the database home was created appears on the page.
4. Click **Actions** next to a database home entry, then **Delete**, and then confirm the action to delete a database home.

Migrating Databases

Review these topics to learn how to prepare for and migrate an entire database to your Oracle Database Appliance.

- [About Migrating Databases](#)
You can migrate an entire active container database (CDB) or non-CDB database to an Oracle Database Appliance machine by using the RMAN duplicate command.
- [Configuring a Static Listener](#)
Configure a static listener before you duplicate a database.
- [Migrating a Database](#)
Use the `RMAN Duplicate` command to migrate the entire database to the appliance.
- [Registering a Database](#)
Use the `odacli register-database` command to register the migrated database with the appliance.

About Migrating Databases

You can migrate an entire active container database (CDB) or non-CDB database to an Oracle Database Appliance machine by using the RMAN duplicate command.

When using RMAN Duplicate, ensure to have network connectivity from source and target databases:

- Source database: The existing database to be migrated.
- Target database: The new database created on an Oracle Database Appliance environment.

If you do not have network connectivity between the source and the target environments, you can use the offline migration method. Offline migration uses RMAN backup sets for duplication, which does not require connectivity to the primary database.

At a high level, the procedure involves the following steps:

1. Deploy or update Oracle Database Appliance to the latest version.

Confirm that the provisioning completed successfully. On bare metal systems, use the command `odacli list-jobs` and the command `odacli describe-job` to verify the status.

2. Create an instance only database from the command-line interface.

- On bare metal systems, use the command `odacli create-database` with the `instanceonly` flag on an Oracle Database Appliance machine. The new database is the target database.

Creating an instance only database also creates the following:

- ACFS Filesystem used to store the database files
- Directory structures that are required by the database instance/`rman duplicate` command
- Password file for the SYS user

3. Configure a static listener.

4. Migrate the existing database to the target database using the backup and restore operations.

5. Register the migrated database with the appliance.

 **Note:**

You can only migrate and register a database of the same storage type. For example, to migrate and register an Oracle ACFS database, you must create an Oracle ACFS database and then migrate and register it. Similarly, to migrate an Oracle ASM database, you must create an Oracle ASM database and then migrate it.

Configuring a Static Listener

Configure a static listener before you duplicate a database.

The static listener is only required when using RMAN Duplicate command.

Perform the following steps to manually configure the `listener.ora` file:

1. Log in as a grid user.
2. Navigate to `/u01/app/19.0.0.0/grid/network/admin/` directory.
3. Edit the default `listener.ora` file and append the static database entry.

```
SID_LIST_LISTENER=  
  (SID_LIST=  
    (SID_DESC=  
      (SID_NAME=  
        ORCL)  
      (ORACLE_HOME=  
        /u01/app/19.0.0.0/grid/oracle/product/19.0.0.0/oracle_19c)  
      (DESCRIPTION_LIST=  
        (DESCRIPTION=  
          (ADDRESS_LIST=  
            (ADDRESS=  
              (PROTOCOL=  
                TCP)  
                (HOST=  
                  192.168.1.1)  
                (PORT=  
                  1521)  
              )  
            )  
          )  
        )  
      )  
    )  
  )  
)
```

```

        (GLOBAL_DBNAME=db_unique_name with domain)
        (ORACLE_HOME=db home)
        (SID_NAME=db unique name)
        (ENVS="TNS_ADMIN=database home/network/admin"))
    )

```

For example, the following file is edited for an 19.10.0.0 database named PRODDB in the example.com domain:

```

SID_LIST_LISTENER=
  (SID_LIST=
    (SID_DESC=
      (GLOBAL_DBNAME=PRODDB.example.com)
      (ORACLE_HOME=/u01/app/oracle/product/19.0.0.0/dbhome_2)
      (SID_NAME=PRODDB)
      (ENVS="TNS_ADMIN=/u01/app/oracle/product/19.0.0.0/
dbhome_2/network/admin"))
    )

```

4. Save the file.
5. Restart the listener.

```

srvctl stop listener -l listener
srvctl start listener -l listener

```

Migrating a Database

Use the `RMAN Duplicate` command to migrate the entire database to the appliance.

Before migrating the database, verify that a network connection exists between the source and destination databases.

1. Verify that the `sysdba` connection to the auxiliary database is working. Use the password that you defined when you created the database with the `--instanceonly` flag.

```

sqlplus sys/password@hostname:PORT/GLOBAL_DBNAME as sysdba << EOF
select 1 from dual;
exit;
EOF

```

The following example uses the `Welcome_12` password for myhost on port 1521 for PRODDB.example.com.

```

sqlplus sys/Welcome_12@myhost:1521/PRODDB.example.com as sysdba <<
EOF
select 1 from dual;
exit;
EOF

```

- As oracle user, set the ORACLE_HOME and ORACLE_SID environment variables.

```
ORACLE_HOME=path of Oracle Home against which the AUX DB is created
ORACLE_SID=database unique name
```

- Display a list of all database storage configured on the appliance and database storage identifiers (ID).

Use the `odacli list-dbstorages` to display the storage IDs for all configured filesystems.

```
# odacli list-dbstorages
ID Type                               DBUnique Name          Status
-----
68d13446-f26c-49ee-ab75-a393732aa88a  Asm          rdbl
Configured
ff2023d9-338d-4cff-8bb4-e73a89e32ce4  Acfs         PRODDB
Configured
```

- Display the database storage details, including the DATA, RECO and REDO locations, for each database storage ID.

For example, use the `odacli describe-dbstorage` command to display information about the ACFS storage for ID 9fe39332-cc1a-4b4b-8393-165524a6ef6b.

```
# odacli describe-dbstorage -i ff2023d9-338d-4cff-8bb4-e73a89e32ce4
DBStorage details
-----
ID: ff2023d9-338d-4cff-8bb4-e73a89e32ce4
DB Name: PRODDB
DBUnique Name: PRODDB
DB Resource ID: c5b77384-634e-4dc8-b10b-fa2831d2c59b
Storage Type: Acfs
DATA Location: /u02/app/oracle/oradata/PRODDB
RECO Location: /u03/app/oracle/fast_recovery_area/
REDO Location: /u03/app/oracle/redo/
State: ResourceState(status=Configured)
Created: June 22, 2019 12:07:12 PM SGT
UpdatedTime: June 22, 2019 12:26:39 PM SGT
```

- Duplicate the database.

Use the `RMAN duplicate database` command to duplicate the database.

```
rman target sys/Welcome__12@source database hostname:PORT
(Continued)
/Service Name auxiliary sys/Welcome_12@Hostname of the target
database:1521/service name
RUN {
SET NEWNAME FOR DATABASE TO NEW;
duplicate target database to PRODDB from active database
SPFILE
```

```

SET cluster_database 'false'
SET audit_file_dest '/u01/app/oracle/admin/PRODDB/adump'
SET db_create_file_dest '/u02/app/oracle/oradata/PRODDB'
SET db_create_online_log_dest_1 '/u03/app/oracle/redo'
SET db_recovery_file_dest '/u03/app/oracle/fast_recovery_area'
SET control_files '/tmp/control_PRODDB.ctl' nofilenamecheck;
}

```

Registering a Database

Use the `odacli register-database` command to register the migrated database with the appliance.

The `dbclass`, `dbshape`, `servicename` and `password` are mandatory for registering the database. The `dbclass` and `dbshape` determine the `sga_target` and `pga_target` settings. The database `init.ora` parameters are reset as part of the `odacli register-database` command. Review the `init.ora` parameters after registration and ensure that the parameters set correctly.



Note:

The `odacli register-database` command is supported only for primary database of type single-instance.

Follow these steps to register a database:

1. If you have Oracle Database version 12.1 with SQL patches, ensure that the `sqlpatches` are in the Oracle Database Appliance environment. If the patches are not in the environment, copy the `$OH/sqlpatch` directories from the source database home to the `$OH` in Oracle Database Appliance before executing the `odacli register-database` command

The `odacli register-database` command invokes the `datapatch` utility for applying the post patch SQLs. If the source database has any `sqlpatches` applied that are not present in the Oracle Database Appliance environment, then the `datapatch` will fail.

2. If you have Oracle Database version 11.2 with SQL patches, you must roll back any patches applied to the source database that are not part of the installed Oracle Database Bundle patch (BP).
3. Register the database with Oracle Database Appliance.

```

# odacli register-database -c OLTP -s odbl -sn proddb.example.com -p
Password for SYS:
{
  "jobId" : "317b430f-ad5f-42ae-bb07-13f053d266e2",
  "status" : "Created",
  "message" : null,
  "reports" : [ ],
  "createTimestamp" : "August 08, 2018 05:55:49 AM EDT",
  "description" : "Database service registration with
                  db service name: proddb.example.com",
  "updatedAtTime" : "August 08, 2018 05:55:49 AM EDT"
}

```

```
}
rpandrap: ]# odacli describe-job -i "317b430f-ad5f-42ae-
bb07-13f053d266e2"
```

Job details

```
-----
ID: 317b430f-ad5f-42ae-bb07-13f053d266e2
Description: Database service registration with
             db service name: proddb.example.com
Status: Success
Created: November 23, 2018 5:55:49 AM EDT
Message:
```

Task Name	Start Time
restore control file	November 23, 2018 5:55:49 AM EDT
move spfile to right location	November 23, 2018 5:56:08 AM EDT
register DB with clusterware	November 23, 2018 5:56:13 AM EDT
reset db parameters	November 23, 2018 5:57:05 AM EDT
Running DataPatch	November 23, 2018 5:57:36 AM EDT

(Continued)

End Time	Status
November 23, 2018 5:56:08 AM EDT	Success
November 23, 2018 5:56:13 AM EDT	Success
November 23, 2018 5:57:05 AM EDT	Success
November 23, 2018 5:57:36 AM EDT	Success
November 23, 2018 5:57:49 AM EDT	Success

4. Use the `odacli list-databases` command to view the registered database.

About Managing Multiple Database Instances Using Instance Caging

Use instance caging to manage your system resources on Oracle Database Appliance.

Oracle Database provides a method for managing CPU allocations on a multi-CPU server that runs multiple database instances. This method is called instance caging. Instance caging uses an initialization parameter to limit the number of CPUs that an instance can use simultaneously.

Instance caging and Oracle Database Resource Manager (the Resource Manager) work together to support your desired service levels across multiple instances. Consolidation can minimize idle resources, maximize efficiency, and lower costs.

Oracle Database Appliance templates are already tuned for the size of each database instance workload. They are designed to run on a specific number of cores. Instance caging ensures that each database workload is restricted to the set of cores allocated by the template, enabling multiple databases to run concurrently with no performance degradation, up to the capacity of Oracle Database Appliance. You can select database template sizes larger than your current needs to provide for planned growth.

 **Note:**

Oracle strongly recommends that you use the Oracle Database Appliance templates, because they implement best practices and are configured specifically for Oracle Database Appliance.

The Oracle Database Appliance Manager interface refers to the database sizing templates as database classes.

By default, instance caging is not enabled on Oracle Database Appliance. To enable instance caging, set the initialization parameter, `RESOURCE_MANAGER_PLAN`, for each database on Oracle Database Appliance. The parameter specifies the plan to be used by the Resource Manager for the current instance. Setting this parameter directs the Resource Manager to allocate core resources among databases. If a plan is not specified with this parameter, then the Resource Manager and instance caging are not enabled.

Instance caging allocation of core resources is enabled in accordance with the Oracle Database Appliance database template size that you select for each database. The `CPU_COUNT` initialization parameter is set in the template. Use the `CPU_COUNT` setting that matches the size of each database to consolidate, and follow the standard instructions for configuring instance caging.

Oracle EM Express and DB Console

You can use Oracle Enterprise Manager Database Express (EM Express), or the Database Control Console (DB Console) to manage your database.

The EM Express console is available for Oracle Database 18c, 12.2.0.1, and 12.1.0.2. The DB Console is available for Oracle Database 11.2.0.4. Both consoles are web-based tools for managing Oracle Databases.

The EM Express console provides the following features:

- Support for basic administrative tasks, such as storage and user management
- Comprehensive solutions for performance diagnostics and tuning
- Performance advisors in a graphic user interface
- Oracle Database utilities in a graphic user interface, such as SQL*Loader and Oracle Recovery Manager (RMAN)

EM Express is built inside the database server and cannot perform actions outside the database.

9

Managing Storage

You can add storage to fully populate the base storage shelf and add a storage expansion shelf to your Oracle Database Appliance.

- [About Managing Storage](#)
You can add storage at any time without shutting down your databases or applications.
- [Preparing for Storage Expansion](#)
Review and perform these best practices before adding storage to the base shelf or adding the expansion shelf.

About Managing Storage

You can add storage at any time without shutting down your databases or applications.

Oracle Database Appliance uses raw storage to protect data in the following ways:

- Flash or Fast Recovery Area (FRA) backup. Flash or fast recovery area is a storage area (directory on disk or Oracle ASM diskgroup) that contains redo logs, control file, archived logs, backup pieces and copies, and flashback logs.
- Mirroring. Double or triple mirroring provides protection against mechanical issues.

The amount of available storage is determined by the location of the FRA backup (external or internal) and if double or triple mirroring is used.

Oracle Database Appliance uses storage shelves, a base shelf and an optional storage expansion shelf. You can expand the base storage by adding a pack of solid-state drives (SSDs) to fully populate the base storage. You can further expand the storage by adding a second storage shelf. External NFS storage is supported for online backups, data staging, or additional database files.

Note:

The storage expansion shelf is no longer available for Oracle Database Appliance X7-2-HA and other older models. You can repurpose an existing storage expansion shelf from one Oracle Database Appliance system to another.

Note:

Oracle recommends that you upgrade your deployment to the latest Oracle Database Appliance software release before adding storage to ensure that your appliance has the latest firmware.

When you add storage, Oracle Automatic Storage Management (Oracle ASM) automatically rebalances the data across all of the storage including the new drives. Rebalancing a disk group moves data between disks to ensure that every file is evenly spread across all of the disks in a disk group and all of the disks are evenly filled to the same percentage. Oracle ASM automatically initiates a rebalance after storage configuration changes, such as when you add disks.

Preparing for Storage Expansion

Review and perform these best practices before adding storage to the base shelf or adding the expansion shelf.

1. Update Oracle Database Appliance to the latest Patch Bundle before expanding storage.
2. Confirm both nodes are at the same version and patch bundle level for software and firmware.

```
# odaadmcli show version -detail
```

```
# odaadmcli inventory -q
```

 **Note:**

If oakd is not running in the foreground mode, on either node, fix the problem before adding storage.

3. Check the disk health of the existing storage disks.

Run the check on both nodes and use the default checks option to check the NetworkComponents, OSDiskStorage, SharedStorage, and SystemComponents.

```
# odaadmcli validate -d
```

4. Run the `odaadmcli show diskgroup` command on each node to display and review Oracle Automatic Storage Management (Oracle ASM) disk group information. Verify that all disks are listed, are online, and are in a good state.

```
# odaadmcli show diskgroup data
```

```
# odaadmcli show diskgroup reco
```

```
# odaadmcli show diskgroup redo
```

5. Confirm Oracle ASM and CRS health on both nodes.

Run the `odaadmcli orachk` command on each node. If there is a problem connecting to either node, then check the `/etc/bashrc` file and remove (or remark out) any values in the profile for root, oracle, grid users.

Run `odaadmcli orachk` on Node 0:

```
# odaadmcli orachk
...
Checking Status of Oracle Software Stack - Clusterware, ASM, RDBMS
. . . . .
-----
Oracle Stack Status
-----
Host Name CRS Installed ASM HOME RDBMS Installed CRS UP ASM UP RDBMS UP DB Instance
Name
-----
odax3rm1 Yes No Yes No No
No
-----
...

```

Run `odaadmcli orachk` on Node 1:

```
# odaadmcli orachk
...
Checking Status of Oracle Software Stack - Clusterware, ASM, RDBMS
. . . . .
-----
Oracle Stack Status
-----
Host Name CRS Installed ASM HOME RDBMS Installed CRS UP ASM UP RDBMS UP DB Instance
Name
-----
odax3rm2 Yes Yes Yes Yes Yes Yes b22S2
b23S2 b24S2
-----
...

```

- 6. Confirm communications between the nodes and that SSH is working using the same password for `oracle`, `root`, and `grid`.

From each node:

- a. `ssh` to both nodes.
 - b. Ping both nodes.
- 7. Confirm there is at least 10 GB of space available on each node.

```
[root@oda]# df -h
```

```
[root@odb]# df -h
```

10

Backup, Restore and Recover Databases

Review backup, restore, and recovery operations for your databases.

- [About Database Backup and Recovery Options](#)
Backup your databases in Oracle Database Appliance and use the restore and recover features to restore a database to the same or another system or to recover database files.
- [Creating a Mount Point for NFS Backup Location](#)
Create a mount point for the Network File System (NFS) location, to set up the NFS backup and recovery option.
- [Configuring Agent Proxy Settings for Object Store Access](#)
If the Object Store IP address is accessible only through proxy setup by the Oracle Database Appliance server, then define the proxy setting for the agent, so that the agent can access the Object Store.
- [Creating a Database Backup Policy](#)
Understand how to create a policy to backup a database to an internal or external Oracle Fast Recovery Area (FRA) location or to the Object Store using the Browser User Interface.
- [Updating a Database with a Backup Policy](#)
Attach a backup policy to a database to define the database backup attributes and destination.
- [Updating a Database Backup Policy](#)
Use the Browser User Interface to update the recovery window, change the ObjectStore Credential, or change the crosscheck option for a database backup policy.
- [Backing Up a Database Using the Browser User Interface](#)
Apply a backup policy to a database, create a manual backup, update a database backup schedule, or update an archive log backup scheduler.
- [Viewing Backup Reports](#)
Understand how you can use the Browser User Interface to view backup reports.
- [Recovering a Database Using the Browser User Interface](#)
Understand the recovery options available for recovering a database.
- [Deleting a Backup Using the Browser User Interface](#)
Use the Browser User Interface to delete database backups.
- [Deleting a Backup Policy](#)
Use the Browser User Interface to delete a database backup policy.
- [Using the CLI to Backup, Restore, and Recover](#)
Use the command-line interface to backup, restore, and recover databases.

About Database Backup and Recovery Options

Backup your databases in Oracle Database Appliance and use the restore and recover features to restore a database to the same or another system or to recover database files.

It is important to create a backup recovery strategy to protect the databases in Oracle Database Appliance from data loss due to a physical problem with a disk that causes a failure of a read from or write to a disk file that is required to run the database, or due to user error. The backup feature provides the ability to PITR restore the database, SCN recovery, and latest recovery. You can create a backup policy in the Browser User Interface or from the command-line interface.

The following backup options are available:

- Backup to an Oracle Fast Recovery Area (FRA) disk (Internal FRA)
- Backup to Oracle Cloud Infrastructure Object Storage (Oracle Object Storage)
- Backup to a Network File System (NFS) location (External FRA)

You can use the backup, restore, and recovery features with databases that have backup policy attached to them in the system. You can choose to manage your backups, and set up your backup, restore, and recovery option.

The backup feature enables you to create a backup policy with your backup parameters, such as backup location, recovery window, enable and disable crosscheck, and ObjectStoreSwift Object details. For new and existing databases, you can create and attach a backup policy to a database to perform a daily backup. Once a backup policy is attached to a database, the `dcs-agent` schedules daily automatic backups for the database. It also schedules archivelog backups for the database. By default, the frequency of the archivelog backup is 30 minutes. The default schedule is a level 0 backup every Sunday and a level 1 backup Monday through Saturday. You can edit or disable the schedule.

The `dcs-agent` generates and saves a backup report for each backup. The backup report contains the metadata required to recover or restore a database.

Recovering a database in Oracle Database Appliance is a full or whole database recovery using RMAN. You can recover from a Backup Report, a point-in-time (PITR), a System Change Number (SCN), or from the latest backup. When a Backup Report is used for recovery, it performs an SCN recovery, by reading the SCN value from the backup report. For recovery of data block, tablespaces, data files, PDBs, see the *Oracle Database Backup and Recovery Reference Guide*.

Backup Policy

The backup policy defines the backup details. When you create a backup policy, you define the destination for the database backups, either Internal FRA (Disk) or External FRA (NFS location), or Cloud Object Storage, and you define the recovery window.

If you use the Oracle Object Storage for backup and recovery, you must have an ObjectStore Resource ID or Name.

You can assign the backup policy to the database when you create the database. You can attach a backup policy to an existing database or update a backup policy.

You can also specify compression algorithm when creating the backup policy. The supported compression algorithms are BASIC, LOW, MEDIUM, and HIGH. For Objectstore backup policy, you can specify any compression algorithm. By default, if you do not specify the compression algorithm while creating the Objectstore backup policy, then MEDIUM compression algorithm is used. By default, if you do not specify the compression algorithm while creating the Disk or NFS backup policy, then BASIC compression algorithm is used. To use LOW, MEDIUM, or HIGH compression algorithms for Disk or NFS backup policy, there are license considerations.

Backup Levels

Specify the backup level when you take a backup. The back levels are:

- **Level 0:** The backup captures all blocks in the datafile. By default, level 0 backups occur every Sunday. You can customize your backup settings through the Browser User Interface or the command-line. A level 0 backup is a full backup and is used as the parent for a level 1 backup.
- **Level 1:** The backup is an incremental backup that captures only those blocks that change between backups in each datafile. By default, a level 1 backup occurs daily, Monday through Saturday, and captures images of each block in a datafile that changed. Level 1 backups are differential backups. The backup includes blocks from the most recent previous level 1 or level 0 backup.
- **LongTerm:** The backup is a long-term, or archival backup. Use LongTerm to create a backup that is all-inclusive and exempt from the backup retention policy. The backup is all-inclusive because every file needed to restore and recover the database is backed up to a single location. The backup is exempt from the retention policy that is defined in the recovery window. For long term backups, you must use External FRA (NFS location) or Objectstore backup policy.
- **Archivelog:** This is a backup of all archivelog not yet backed up to the backup destination, such as Internal FRA, External FRA (NFS location), or Object Store.

The AutoScheduler creates a level 0 backup on Level 0 Backup Day, by default, on Sunday, and level 1 on the remaining days of the week. You can display a list of scheduled backups, edit your backup schedule, or disable a scheduled backup. It also creates archivelog backup for the database with a default frequency of 30 minutes.

Backup to Disk

When you backup to disk, you are using the Oracle Fast Recovery Area (FRA) of the disk. FRA is a storage directory that allows backup and recovery operations on Oracle databases. The directory contains archived redo logs, backup pieces and copies, and the control file.

Advantages to backing up to disk are as follows:

- Quick recovery from backups stored on disk
- Automate management of recovery related files (like archived logs)

 **Note:**

- When you backup to disk, the data for non-TDE database is not encrypted and passwords are not allowed. In addition, backup to disk requires a lot of disk space (up to two to three times the size of the database).
- If the database is TDE-enabled, then the RMAN backup password is not required, irrespective of the backup destination.

The following is a high-level overview of the workflow for backup and recovery when using a disk:

1. Create a backup policy to define the backup destination (disk) and recovery window for the disk destination.
2. Create a database and attach the backup policy to the database. When the backup policy is associated with a database, archivelog backups and database backups are automatically created.
3. Manage obsolete backups.
4. Recover the database from a backup on the disk.

Backup to External FRA (Network File System)

Specifying a Network File System (NFS) location for backups, enables you to safely and securely store or retrieve a database backup at any time.

The advantages of using NFS backup location are:

- With NFS, you can access remote files, locally, by mounting local file systems on a network.
- Provides a centralized backup location, without requiring manual refresh.
- Supports enhanced security options using firewalls and Kerberos.
- Support for encrypted backups using passwords. You optionally, set the backup password, and provide the same during restore operation.
- The RMAN Backup Encryption password is applicable for databases that do not have TDE enabled. If the database has TDE enabled, then the RMAN backup password is not required, irrespective of the backup destination.

The following is a high-level overview of the workflow for backup and recovery when using an NFS location:

1. Create a mount point for the NFS location.

The mount point must be accessible from both nodes. The `oracle` user must have read/write permissions to the NFS location. If the request is being made to a remote server, ensure that it is running. See *Creating a Mount Point for NFS Backup Location* for the procedure to create a mount point.
2. Create a backup policy specifying the NFS location, and the recovery window for NFS destination.
3. Associate the database with this backup policy, either during database creation, or by updating the backup policy for the database.

4. Backups are automatically scheduled, and you can also run manual backups. You can specify manual backup options in the Browser User Interface or using ODA CLI commands.
5. Manage obsolete backups.
6. Restore from backup. When you save your backups to NFS, you can restore the database to the same system or to a different system.
7. Recover the database from a backup on NFS.

Backup to Oracle Object Storage

Oracle Object Storage is a highly secure, scalable storage platform that enables you to safely and securely store or retrieve a database backup at any time. Data and the associated metadata are stored as an object in a logical container (bucket). Oracle Database Appliance creates a Backup Report and a unique ID to identify each backup.

Oracle Object Storage is tightly integrated with Oracle Cloud Infrastructure Identity and Access Management. The data, user-defined metadata associated with the data, and encryption keys are automatically encrypted using 256-bit Advanced Encryption Standard (AES- 256). The encryption keys are rotated frequently and cannot be disabled. By default, only authenticated users that have explicitly been granted access to specific resources can access data stored in Oracle Object Storage. Data is uploaded and downloaded over SSL endpoints using the HTTPS protocol.

When you backup to Oracle Object Storage, you are using your backup policy and your Oracle ObjectStoreSwift credentials. The credentials are stored in an encrypted Oracle wallet. You can attach the credentials to one or more backup policies.

Note:

Credentials are validated when you create the backup policy that uses Oracle Object Storage. The credentials are not validated against the URL and tenancy.

Advantages to using Oracle Object Storage are as follows:

- Backups are encrypted using the password for non-TDE databases. For TDE-enabled databases, backups are encrypted by default and do not require the RMAN backup encryption password to be specified separately.

Caution:

Save the password that you use during backups in a safe location, you must provide the password during recovery operations.

- Quick recovery from backups. With the Oracle Object Storage, you can safely and securely use the Browser User Interface to store or retrieve data directly from within the cloud platform, at any time.
- Automate management of recovery related files (like archived logs)
- Oracle Object Storage is not directly accessed by the operating system, instead it uses APIs to access the storage at the application level.

The following is a high-level overview of the workflow for backup and recovery when using Oracle Object Storage:

1. Create an Object Store object with your credentials.
2. Create a backup policy to define the backup location (Object Store), Object Store Credentials Name, the container (bucket) name where you want to store backups, and the recovery window.
3. Create a database and attach the backup policy either as a part of creating the database, or update the database with backup policy after creating the database. When the backup policy is associated with a database, backups are automatically created.
4. Manage obsolete backups.
5. Restore from backup. When you save your backups to Oracle Object Storage, you can restore the database to the same system or to a different system.
6. Recover the database from a backup on Oracle Object Storage.

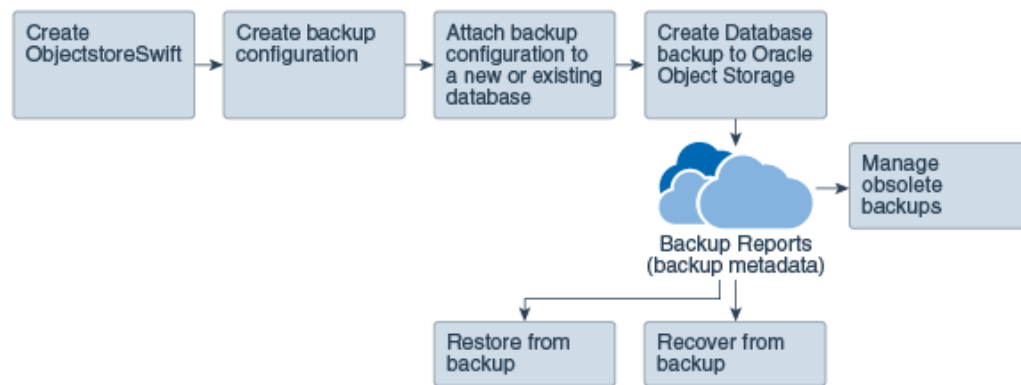

 **Note:**

Before you can use this backup option, you must create an Oracle Cloud Infrastructure Object Storage account. When you create the account, you define the account credentials, end point URL, and bucket. Go to the [Oracle Store](#) and sign up for Oracle Cloud Infrastructure Object Storage.

Backup Reports

A backup report is generated for each backup and is similar to, but does not replace, a recovery catalog. The report contains the Oracle Database Appliance information and metadata needed to restore or recover a database. The Backup Report is designed to keep track of all of the information required to restore or recover a database.

The following is an example of a level 1 backup report:

```

{
  "id" : "2d82460c-d648-4e75-8c7d-72cc90bc442a",
  "dbResId" : "b5fc646e-01a6-4c8b-8286-7633346c4329",
  "tag" : null,
  "dbId" : "2717054291",
  "dbName" : "HRDbO",
  "dbUniqueName" : "HRDbOu",
  "backupType" : "REGULAR-L1",
}
  
```

```

"keepDays" : null,
"backupLocation" : "https://swiftobjectstorage.us-phoenix-1.oraclecloud.com/v1/dbaasimage/backupbucket",
"cfBackupHandle" : "c-2717054291-20171108-04",
"spfBackupHandle" : "c-2717054291-20171108-04",
"pitrTimeStamp" : "November 08, 2017 12:43:14 PM UTC",
"pitrSCN" : "1175058",
"resetLogsTimeStamp" : "November 08, 2017 09:55:34 AM UTC",
"resetLogsSCN" : "1112268",
"oraHomeVersion" : "12.2.0.1.170814 (26723265, 26609817)",
"sqlPatches" : "25811364,26609817",
"backupLogLoc" : "https://swiftobjectstorage.us-phoenix-1.oraclecloud.com/v1/dbaasimage/backupbucket/scaoda702c1n1/
rmanlog/HRDbOu/2717054291/2017-11-08/rman_backup_2017-11-08_12-42-41.0545.log",
"tdeWalletLoc" : null,
"dbConfigLoc" : "https://swiftobjectstorage.us-phoenix-1.oraclecloud.com/v1/dbaasimage/backupbucket/scaoda702c1n1/
dbconfig/HRDbOu/2717054291/2017-11-08/DBCONFIG_TAG20171108T124407_2017-11-08_12-44-07.0533.tar.gz",
"name" : "Backup_Report_HRDbO",
"createTime" : "November 08, 2017 12:42:08 PM UTC",
"state" : {
  "status" : "CONFIGURED"
},
"updatedAt" : "November 08, 2017 12:44:12 PM UTC",
"backupReportLogDetail" : "https://swiftobjectstorage.us-phoenix-1.oraclecloud.com/v1/dbaasimage/backupbucket/
scaoda702c1n1/rmandetaillogreport/HRDbOu/2717054291/2017-11-08/rman_list_backup_detail_2017-11-08_12-44-04.0362.log",
"dbInfo" : {
  "dbClass" : "OLTP",
  "dbType" : "RAC",
  "dbShape" : "odbl",
  "dbEdition" : "EE",
  "dbStorage" : "ASM"
},
"dbDataSize" : "1542M",
"dbRedoSize" : "16403M"
}

```

About Recovery Options

The recovery in Oracle Database Appliance always performs a full database restore or recover. The recovery options are LATEST, PITR, SCN, and BackupReport.

The following types of recovery are available:

- **LATEST:** Performs a complete recovery (valid backups and all required archived logs and online redo logs must be available)
- **PITR:** Point-in-Time Recovery that performs a recovery to a specified timestamp within the current incarnation of database
- **SCN:** SCN-based recovery that performs a recovery is an incomplete recovery to a specified SCN within the current incarnation of database.
- **BackupReport:** Performs a recovery based on the Backup Report SCN. The BackupReport option is similar to SCN, except that the recovery uses the Backup Report SCN instead of a specified SCN.

Point-in-Time Database Recovery

Point-in-Time Recovery (PITR) recovers the database to a specific point-in-time. You must use specify the timestamp for this type of recovery.

A point-in-time recovery is often used for the following situations:

- You want to recover the database to an SCN before a user or administrative error.
- Complete database recovery failed because all necessary archived redo logs were not available.
- A database upgrade fails.
- You are creating a test database or a reporting database from production database backups.

System Change Number Recovery

A system change number (SCN) is a stamp that defines a committed version of a database at a point in time. Oracle assigns every committed transaction a unique SCN. You can recover a database to the latest time or to an SCN.

The database is restored from backups created before the target time, and then applies incremental backups and logs to re-create all changes between the time of the data file backups and the end point of recovery. When the end point is specified as an SCN, the database applies the redo logs and stops after each redo thread or the specified SCN, whichever occurs first. When the end point is specified as a time, the database internally determines a suitable SCN for the specified time and then recovers to this SCN.

SCN is a primary mechanism to maintain data consistency in Oracle database. With each execution, there is an increase in the count of the SCN. The following are some examples of areas that use SCN:

1. Redo records. Every redo record has an SCN version of the redo record in the redo header (redo records can have non-unique SCN). Given redo records from two threads (as in the case of RAC), recovery will order them in SCN order, essentially maintaining a strict sequential order.
2. Data block. Every data block has block SCN (block version). In addition to that, a change vector in a redo record also has expected block SCN. This means that a change vector can be applied to one and only version of the block. Code checks if the target SCN in a change vector is matching with the block SCN before applying the redo record. If there is a mismatch, corruption errors are thrown.
3. Read consistency. Every query has query environment which includes an SCN at the start of the query. A session can see the transactional changes only if that transaction commit SCN is lower than the query environment SCN.
4. Commit. Every commit generates an SCN (commit SCN) that marks a transaction boundary. Group commits are possible too.

Restoring Archivelog

The database auto backup policies - Regular-L0, and Regular-L1 delete archivelog, which could be essential in later process, such as in configuration or reinstate operations for Oracle Data Guard. Oracle Database Appliance supports restore of archivelog for a database. You can choose to restore archivelog from one SCN to another SCN, or from one timestamp to another timestamp.

Run the command `odacli restore-archivelog` specifying the SCN or timestamp period.

Obsolete Database Backups

It is important to remove older backups once they become obsolete. The type of backup and the recovery window that you define in the database backup policy determines when database backups become obsolete.

For level 0 and level 1 backups, run the command `odacli delete-backup` for a given Database Resource Identifier to delete obsolete backups based on the defined recovery window.

For Longterm backups, provide the corresponding backup report as an input and use the command `odacli delete-backup` to delete the backups from Oracle Object Storage.

Typically, older level 0 and level 1 database backups are considered obsolete and deleted based on the defined recovery window, as follows:

- Disk: 1-14 days
- Object Storage: 1-31 days

Creating a Mount Point for NFS Backup Location

Create a mount point for the Network File System (NFS) location, to set up the NFS backup and recovery option.

Follow these steps to create a mount point for the NFS location:

1. Follow these steps on the source machine:
 - a. Create a sharable location on the source machine and give full permissions to this directory.

```
# mkdir /tmp/nfs_test
chmod 774 /tmp/nfs_test
```

- b. Add entries in the `/etc/exports` file in the format `shared_location destination_IPs (permissions)`.

For example:

```
# cat /etc/exports
/tmp/nfs_test 192.0.2.1(rw, sync)
/tmp/nfs_test 192.0.2.2(rw, sync)
```

- c. Restart the NFS server on the host.

```
# service nfs restart
```

- d. Check the export list for the entries.

```
# showmount -e
Export list for odal:
/tmp/nfs_test 192.0.2.1,192.0.2.2
```

2. Follow these steps on the client machine:
 - a. Create a client location on the client machine as the `oracle` user.

```
# sudo -E -u oracle mkdir /tmp/client_location
```

- b. Mount this location with the source location in the format `mount_server:source_folder client_location`.

```
# mount 192.0.2.3:/tmp/nfs_test /tmp/client_location
```

- c. Check if the mount details are correct:

```
# mount
192.0.2.3:/tmp/nfs_test on /tmp/client_location type nfs
(rw,vers=4,addr=192.0.2.3,clientaddr=192.0.2.2)
```

Specify this NFS location in the backup configuration, either through the Browser User Interface or CLI commands.

Related Topics

- [Preparing for Database Backup to NFS Location](#)
Use the command-line interface to create a policy to backup a database to an External FRA (NFS Location).

Configuring Agent Proxy Settings for Object Store Access

If the Object Store IP address is accessible only through proxy setup by the Oracle Database Appliance server, then define the proxy setting for the agent, so that the agent can access the Object Store.

To create a backup policy that uses Object Store location, the agent must be able to access the Object Store URL.

1. Define the `HttpProxyHost` and `HttpProxyPort` settings in the `update-agentconfig-parameters` command.

```
# odacli update-agentconfig-parameters -n HttpProxyHost -v www-
proxy.test.com -n HttpProxyPort -v 80 -u
```

Job details

```
-----
ID: 0b0cbf9b-b0ab-4523-a096-5da4e48fc825
Description: Update agent configuration parameter values
[HttpProxyHost, HttpProxyPort]
Status: Created
Created: October 23, 2018 4:56:53 PM IST
Message:
```

```
Task Name Start Time End Time Status
-----
```

For more information about the `update-agentconfig-parameters` command usage, see the Oracle Database Appliance Command-Line Interface.

2. Verify that the update succeeded:

```
# odacli describe-job -i 0b0cbf9b-b0ab-4523-a096-5da4e48fc825
```

Job details

```
-----
ID: 0b0cbf9b-b0ab-4523-a096-5da4e48fc825
Description: Update agent configuration parameter values
[HttpProxyHost, HttpProxyPort]
Status: Success
```

Created: October 23, 2018 4:56:53 PM IST
Message:

Task Name Start Time End Time Status

3. Run the `list-agentconfigParameters` command to view the changes in the proxy settings:

```
# odacli list-agentConfigParameters
```

```
Name Value Description Updated
```

```
-----
```

```
-----
```

```
HttpProxyHost www-proxy.test.com October 23, 2018 4:56:53 PM IST
HttpProxyPort 80 October 23, 2018 4:56:53 PM IST
HttpsProxyHost Https proxy server host October 23, 2018 12:23:21 AM
IST
HttpsProxyPort Https proxy server port October 23, 2018 12:23:21 AM
IST
OSPatchRepos Repo list for OS patching October 23, 2018 12:23:21 AM
IST
```

You can now use the Browser User Interface or the command-line interface to create a backup policy to use the ObjectStore location for backup.

Related Topics

- [odacli update-agentconfig-parameters](#)
Use the `odacli update-agentconfig-parameters` command to modify configuration variables used by the appliance.
- [odacli list-agentconfig-parameters](#)
Use the `odacli list-agentconfig-parameters` command to list configuration variables used by the appliance.

Creating a Database Backup Policy

Understand how to create a policy to backup a database to an internal or external Oracle Fast Recovery Area (FRA) location or to the Object Store using the Browser User Interface.

The backup policy defines the backup, including the location where you want to store the backups and the recovery window. Backup to disk requires a lot of disk space (up to two to three times the size of the database).

Follow these steps to create a backup policy from the Browser User Interface:

1. Click the **Database** tab in the Browser User Interface.
2. Click **Backup Policy** in the left navigation to display a list of backup policies.
3. Click **Create Backup Policy**.
4. Enter a name for the backup policy and select the number of days for the recovery window. Select **Enable Crosscheck** to determine if the files on the disk on in the media management catalog correspond to data in the RMAN repository. Select one of the following as the backup destination:
 - To backup to disk, select **Internal FRA** as the backup destination.

- To backup to the cloud, select **ObjectStore** as the backup destination. If you have more than one Object Store, then select the Object Store Credential Name from the list. Enter a name in the Container Name field.
- To backup to an NFS location, select **External FRA** as the backup destination, and specify the NFS mount point location.
- To not define a destination, select **None**.

The Backup Policy name must begin with an alpha character and contain only alphanumeric characters.

5. You must specify the **TDE Wallet Backup Location** to associate the backup configuration to a TDE-enabled database.
6. Click **Create**. Click **Yes** to confirm that you want to create the backup policy.

A link to the job appears. When the job completes successfully, the backup configuration is ready.

Update an existing database to attach the backup configuration to the database using the ID or Name. When you attach the backup configuration to a database, the `dcS-agent` schedules daily automatic backups for the database.

Updating a Database with a Backup Policy

Attach a backup policy to a database to define the database backup attributes and destination.

1. In the Browser User Interface, click the **Database** tab, then select a database from the list.
2. In the Database Information page, click **Apply Backup Policy**.
If the action is disabled, then you must create a backup policy.
3. Select a backup policy from the list of available backup policies, and provide the **Backup Encryption Password**. For TDE-enabled databases, backups are encrypted by default and do not require the RMAN backup encryption password to be specified separately. Click **Apply**.
4. Expand the **Actions** menu, then click **View** to display the Database Information page.

The details include whether or not Auto Backup is enabled, the Backup Destination, and options to create a backup, enable or disable automatic backups, update the database, and archive log backup schedule.

5. (Optional) Click **Manual Backup** to create a single backup. Click **Update Database Backup Schedule** to schedule automatic backups. Click **Update Archive Log Backup Schedule** to schedule archive log backups.
6. Click the **Activity** tab to check the job status.

When the job completes successfully, the backup policy is associated with the database.

Updating a Database Backup Policy

Use the Browser User Interface to update the recovery window, change the ObjectStore Credential, or change the crosscheck option for a database backup policy.

Crosscheck determines if the files on the disk on in the media management catalog correspond to data in the RMAN repository.

1. Click the **Database** tab in the Browser User Interface.
2. Click **Backup Policy** in the left navigation to display a list of backup policies.
3. Expand the **Actions** menu for a backup policy, then click **Update**.
4. To change the recovery window, use the up or down arrow to change the number of days.
5. To enable or disable the crosscheck, select or deselect **Enable Crosscheck**.
6. Click **Update**. Click **Yes** to confirm that you want to update the backup policy.
A link to the job appears. When the job completes successfully, the backup configuration is ready.

Backing Up a Database Using the Browser User Interface

Apply a backup policy to a database, create a manual backup, update a database backup schedule, or update an archive log backup scheduler.

You can use the Browser User Interface or the command-line interface to create a database backup. In the command-line interface, use the command `odacli create-backup` for a specified Database.

Before creating a database backup, you must have a backup policy. The backup policy defines the recovery window and the backup destination. You must associate a backup policy with the database, otherwise you cannot create backups.

Follow these steps to backup a database from the Browser User Interface:

1. In the Browser User Interface, click the **Database** tab.
2. Click a database name to select a database from the list.
3. Review the database information, including the backup policy name and destination details. To select a backup policy for the database, click **Apply Backup Policy**. Select a policy and specify the **Backup Encryption Password**. For TDE-enabled databases, backups are encrypted by default and do not require the RMAN backup encryption password to be specified separately. For databases that do not have TDE enabled, the **Backup Encryption Password** is mandatory for Objectstore backup destination, optional for NFS backup destination and not required for Disk backup destination.
4. Click **Manual Backup**, **Update Database Backup Schedule** or **Update Archive Log Backup Schedule**.
If the action is disabled, then apply a backup policy.
5. Click **Yes** to confirm the job.

A link to the job appears. When the job completes successfully, the backup is ready. A list of backups appears at the bottom of the page.

Viewing Backup Reports

Understand how you can use the Browser User Interface to view backup reports.

A report is generated when a database backup is performed. The backup report lists the type, location, and date and timestamp of the backup.

1. In the Browser User Interface, click the **Database** tab, then click the database name in the list of databases.
Information about the database appears on the Database Information page.
2. Scroll to the bottom of the page to view a list of Backups.
3. Click the Job ID for a backup to view the Backup Report and more details about the backup.

Recovering a Database Using the Browser User Interface

Understand the recovery options available for recovering a database.

1. In the Browser User Interface, click the **Database** tab, then select a database from the list.
2. On the Database Information page, click **Recover**.
3. On the Recover Database page, select any of the following recovery options:
 - Recover Full Database to the specified Backup:** Select the existing backup from which you want to recover the database
 - Recover Full Database to the Latest:** Select this option to recover the database from the last known good state, with the least possible data loss.
 - Recover Full Database to the specified Timestamp:** Specify the timestamp to recover the database.
 - Recover Full Database to the System Change Number (SCN):** Specify the SCN of the backup from which you want to recover the database.
4. Specify and confirm the **Backup Encryption Password** for databases without Transparent Database Encryption (TDE) enabled.
5. If the database has TDE enabled, then the **TDE Wallet Backup Location** and **TDE Password** fields are displayed.
6. Click the **Activity** tab to check the job status.
When the job completes successfully, the database is recovered as per the specified recovery options.

Deleting a Backup Using the Browser User Interface

Use the Browser User Interface to delete database backups.

You can delete Level-0, Level-1, and Archive Log backups anytime. To delete long term backups, you must check the Backup Report for the database to determine when the backup is obsolete.

1. Click the **Database** tab in the Browser User Interface.

2. Click the database name, in blue font, to display more details about the database for which you want to delete the backup.
3. Click **Delete Backups**.
4. Select the Backup type you want to delete, whether Level-0, Level-1, and Archive Log backup or long Term backup, then click **Start**. Click **Yes** to confirm that you want to delete the backup.

A link to the job appears. When the job completes successfully, the backup is deleted.

Deleting a Backup Policy

Use the Browser User Interface to delete a database backup policy.

1. Click the **Database** tab in the Browser User Interface.
2. Click **Backup Policy** in the left navigation to display a list of backup policies.
3. Expand the **Actions** menu for a backup policy, then click **Delete**. Click **Yes** to confirm that you want to delete the backup policy.

A link to the job appears. When the job completes successfully, the backup policy is deleted.

Using the CLI to Backup, Restore, and Recover

Use the command-line interface to backup, restore, and recover databases.

- [Preparing for Database Backup to Disk](#)
Use the command-line interface to create a policy to backup a database to the Oracle Fast Recovery Area (FRA) of a disk.
- [Preparing for Database Backup to NFS Location](#)
Use the command-line interface to create a policy to backup a database to an External FRA (NFS Location).
- [Preparing for Database Backup to Oracle Cloud](#)
Create a backup configuration to backup a database to Oracle Cloud Infrastructure Object Storage.
- [Backing Up a Database with the CLI](#)
Create a level 0, level 1, LongTerm database backup, or archivelog backup with the command-line interface.
- [Recovering a Database with the CLI](#)
Recover the database to the system using a Backup Report, point-in-time recovery (PITR), a system change number (SCN), or from the latest backup time.
- [Restoring a Database with the CLI](#)
You can restore a database to a system from Oracle Object Storage or NFS backup location using a backup report and the command-line interface.
- [Restoring Archivelog with the CLI](#)
You can restore archivelog from one SCN to another SCN, or from one timestamp to another timestamp using the command-line interface.
- [Deleting Backups with the CLI](#)
Delete older, obsolete level 0, level 1 and long term backups.

Preparing for Database Backup to Disk

Use the command-line interface to create a policy to backup a database to the Oracle Fast Recovery Area (FRA) of a disk.

You can create a backup policy using the Browser User Interface or the command-line interface. Most of the backup and recovery commands enable you to provide either a resource name or resource ID to identify the database.

Backup to disk or the **Backup to Internal FRA** option in the Browser User Interface, requires a lot of disk space (up to two to three times the size of the database).

Follow these steps to create a backup policy through the command-line interface:

1. Create a BackupConfig object (backup configuration) using the command `odacli create-backupconfig`.

The backup configuration defines the backup, including the location where you want to store the backups and the recovery window.

The following example creates a backup configuration named `mkgl1dailydisk` with a backup to disk and a 1 day recovery window.

```
# odacli create-backupconfig -d Disk -n mkgl1dailydisk -w 1
```

2. Check the job status.

```
# odacli list-jobs
```

When the job completes successfully, the backup configuration is ready.

3. Update an existing database to attach the backup configuration to the database using the ID or Name.

When you attach the backup configuration to a database, the `dcs-agent` schedules daily automatic backups for the database.

The following example uses the Database Resource ID and Backup Configuration ID:

```
# odacli modify-database -i d3c4d8f6-5eb7-4f9e-ab27-7bdd5013ac90 -  
bi 9d942e0a-ba00-4cbc-9bfb-0de83ed279e5 -bp
```

The following example uses the Database Resource Name, `mydb` and the Backup Configuration Name, `mydb`:

```
# odacli modify-database -in mydb -bin mybcbfg -bp
```

You can create manual backups or scheduled backups to disk.

Preparing for Database Backup to NFS Location

Use the command-line interface to create a policy to backup a database to an External FRA (NFS Location).

You can create a backup policy using the Browser User Interface or the command-line interface. Most of the backup and recovery commands enable you to provide either a resource name or resource ID to identify the database.

Backup to NFS location or the **Backup to External FRA** option in the Browser User Interface, requires creation of an NFS mount point.

Follow these steps to create a backup policy through the command-line interface:

1. Create a BackupConfig object (backup configuration) using the command `odacli create-backupconfig`.

The backup configuration defines the backup, including the location where you want to store the backups and the recovery window.

The following example creates a backup configuration named `mkgl1daily nfs` with a backup to disk and a 1 day recovery window.

```
# odacli create-backupconfig -d NFS -n mkgl1daily nfs -c absolute-  
path-to-parent-directory-for-NFS-destination -w 1
```

2. Check the job status.

```
# odacli list-jobs
```

When the job completes successfully, the backup configuration is ready.

3. (Optional) Update an existing database to attach the backup configuration to the database using the ID or Name.

When you attach the backup configuration to a database, the `dcs-agent` schedules daily automatic backups for the database.

The following example uses the Database Resource ID and Backup Configuration ID:

```
# odacli modify-database -i d3c4d8f6-5eb7-4f9e-ab27-7bdd5013ac90  
-bi 9d942e0a-ba00-4cbc-9bfb-0de83ed279e5 -bp
```

The following example uses the Database Resource Name, `mydb` and the Backup Configuration Name, `mydb`:

```
# odacli modify-database -in mydb -bin mybcfg -bp
```

The `-bp` option to specify the backup password is not applicable for TDE-enabled databases.

You can create manual backups or scheduled backups to NFS location.

Related Topics

- [Creating a Mount Point for NFS Backup Location](#)
Create a mount point for the Network File System (NFS) location, to set up the NFS backup and recovery option.

Preparing for Database Backup to Oracle Cloud

Create a backup configuration to backup a database to Oracle Cloud Infrastructure Object Storage.

Before you can backup to Oracle Object Storage, you must sign up for an Oracle Cloud Infrastructure Object Storage account and know your Oracle Object Storage credentials. When you create an Oracle ObjectStoreSwift object, the command creates and stores the credential details in the system and stores the password in an encrypted Oracle wallet. The Oracle wallet contains the Oracle Object Storage password.

Go to the Oracle Store to sign up for Oracle Cloud Infrastructure Object Storage.

1. Create an Oracle ObjectStoreSwift object using the command `create-objectstoreswift`.

```
# odacli create-objectstoreswift -e swift end point URL -n Object Store Swift name [-p] swiftpassword -t Object Store tenant name -u Object Store user name
```

For example:

```
# odacli create-objectstoreswift -e https://  
swiftobjectstorage.r1.oracleiaas.com/v1 -n ossn1 -t mytenant -u  
user.name@example.com -p
```

The output includes an objectstoreswift Resource ID to identify an ObjectStoreSwift credential.

2. Create a BackupConfig object (backup configuration) using the command `odacli create-backupconfig`.

The backup configuration defines the backup, including the location (container) where you want to store the backups, the recovery window, and the credentials that are defined in your encrypted Oracle wallet.

The following example creates a backup configuration named `hr_7d_cloud` with a backup to the ObjectStore. The following backup parameters are defined: the container is `hr_bucket`, crosscheck is not enabled, the recovery window is 7 days, and the ObjectStoreSwift Resource ID is provided, which attaches the ObjectStoreSwiftObject to the backup configuration.

```
# odacli create-backupconfig -n hr_7d_cloud -d ObjectStore -w 7  
-o b974f006-5503-4949-ab6c-6f1a56e4ac37 -c hr_bucket -no-cr
```

 **Note:**

If the ObjectstoreSwift Object was not created with valid credentials, then creating the backup configuration will fail.

3. Check the job status.

```
# odacli list-jobs
```

When the job completes successfully, the backup configuration is ready. When you create a new database, you have the option to associate the database with a backup configuration.

4. Update an existing database to attach the backup configuration to the database.

When you attach the backup configuration to a database, the `dc-agent` schedules daily automatic backups for the database.

```
# odacli modify-database -i e3c4d8f6-5eb7-4f9e-ab27-7bdd5013ac10 -  
bi 7d942e0a-ba00-4cbc-9bfb-0de83ed279e5 -bp
```

You can create manual backups outside of scheduled backups, view backup reports, or disable automatic backups.

Backing Up a Database with the CLI

Create a level 0, level 1, LongTerm database backup, or archivelog backup with the command-line interface.

You can create a database backup in the Browser User Interface or with the command-line interface. When you attach a backup configuration object to a database, the `dc-agent` automatically schedules daily backups for the database. The day and time are based on the Oracle Database Appliance time zone. The `AutoSchedule` triggers a level 0 Backup every Sunday, a level 1 the other 6 days of the week, and an archivelog backup every 30 minutes. Use the command `odacli update-schedule` to disable or change the scheduled backup time.

To create a Long Term database backup, or a level 0 or level 1 backup outside of the automatic backups, use the command `odacli create-backup`.

 **Note:**

To recover a database, there must be a level 0 backup taken, so that the backup report contains information about the base backup. Restoring a database to the same system with a different DB Name and DB Unique Name or to another system does not always require a long term database backup report. You can use archivelog, or level 0, or level 1 backup reports as well. If you use the archivelog backup report, a prior database backup must exist. To restore a database to another system, you must have a long term database backup in Oracle Object Storage.

1. Verify that a backup configuration object is associated with the database.

2. Create a single backup, outside of the automatic backups, using the command `odacli create-backup`.

Use the Database Resource ID or Database Name to identify the database to backup, specify the type of backup, and use a tag to create a name for the backup. You can use up to 30 alphanumeric characters for the backup name tag. If you do not select a backup type (level 0, level 1, LongTerm, or archivelog backup), a level 1 backup is performed. For example, create a level 0 backup named `2018Jan02_HRLevel0` for resource ID `20576eb1-bc32-4e34-bf97-fda0b60ca15b`

```
# odacli create-backup -i 20576eb1-bc32-4e34-bf97-fda0b60ca15b -bt
Regular-L0 -t 2018Jan02_HRLevel0
```

When the job finishes, a backup report is generated for the backup. The report contains all of the metadata required to recover a database.

3. (Optional) Display a list of backup reports.

```
# odacli list-backupreports
```

4. (Optional) Display a list of all scheduled backups.

```
# odacli list-schedules
```

Recovering a Database with the CLI

Recover the database to the system using a Backup Report, point-in-time recovery (PITR), a system change number (SCN), or from the latest backup time.

Recovering a database in Oracle Database Appliance is a full RMAN database recovery.

Recovering from a backup report requires JSON input for the backup report.

When recovering a TDE-enabled database, you need not specify the backup password.

1. Display a list of backup reports and locate the latest Backup Report for the database and save the Backup Report ID.

```
# odacli list-backupreports
```

2. Use the Backup Report ID to display the details of the Backup Report. Determine how you want to recover the database: PITR, SCN, or Latest and locate the needed information in the Backup Report.

```
# odacli describe-backupreport -i 7fbb06bf-e3a3-4aed-
b617-4d1cd3d33387
{
  "id" : "7fbb06bf-e3a3-4aed-b617-4d1cd3d33387",
  "dbResId" : "4903d18a-6c20-4860-9ed0-d2ea7bd3d7b9",
  "tag" : "auto",
  "dbId" : "3022438697",
  "dbName" : "tbasml",
  "dbUniqueName" : "tbasml",
```

```
"backupType" : "regular-10",
"keepDays" : null,
"backupLocation" : "https://swiftobjectstorage.us-
ashburn-1.oraclecloud.com/v1/paasdevdbcssi/Bha_Backups",
"cfBackupHandle" : "c-3022438697-20201022-03",
"spfBackupHandle" : "c-3022438697-20201022-03",
"pitrTimeStamp" : "October 22, 2020 07:51:59 AM UTC",
"pitrSCN" : "2549429",
"resetLogsTimeStamp" : "October 22, 2020 05:23:56 AM UTC",
"resetLogsSCN" : "2510142",
"oraHomeVersion" : "19.8.0.0.200714",
"sqlPatches" : "31281355",
"backupLogLoc" : "https://
swiftobjectstorage.us-ashburn-1.oraclecloud.com/v1/paasdevdbcssi/
Bha_Backups/scaoda8s002-c/database/3022438697/tdbasml/rmanlog/
2020-10-22/rman_backup_auto_2020-10-22_07-51-06.0546.log",
"tdeWalletLoc" : "https://
swiftobjectstorage.us-ashburn-1.oraclecloud.com/v1/paasdevdbcssi/
TestLtBackupFailur/scaoda8s002-c/database/3022438697/tdbasml/
tdewallet/ewallet_2020102207525186_tdbasml.pl2",
"dbConfigLoc" : "https://
swiftobjectstorage.us-ashburn-1.oraclecloud.com/v1/paasdevdbcssi/
Bha_Backups/scaoda8s002-c/database/3022438697/tdbasml/dbconfig/
2020-10-22/DBCONFIG_auto_2020-10-22_07-52-43.0230.tar.gz",
"name" : "Backup_Report_tdbasml",
"createTime" : "October 22, 2020 07:51:03 AM UTC",
"state" : {
  "status" : "CONFIGURED"
},
"updatedTime" : "October 22, 2020 07:52:55 AM UTC",
"backupReportLogDetail" : "https://swiftobjectstorage.us-
ashburn-1.oraclecloud.com/v1/paasdevdbcssi/Bha_Backups/scaoda8s002-
c/database/3022438697/tdbasml/rmandetaillogreport/2020-10-22/
rman_list_backup_detail_auto_2020-10-22_07-52-33.0919.log",
"dbInfo" : {
  "dbClass" : "OLTP",
  "dbType" : "SI",
  "dbShape" : "odbl",
  "dbEdition" : "EE",
  "dbStorage" : "ASM",
  "dbRedundancy" : null,
  "pdbName" : null,
  "isCdb" : false
},
"dbDataSize" : "1662M",
"dbRedoSize" : "12298M",
"rmanBackupPieces" :
"https://swiftobjectstorage.us-ashburn-1.oraclecloud.com/v1/
paasdevdbcssi/Bha_Backups/scaoda8s002-c/database/3022438697/tdbasml/
backuppieces/2020-10-22/backupPieces_auto_4903d18a-6c20-4860-9ed0-
d2ea7bd3d7b9_20201022075238.json",
"compressionAlgo" : "MEDIUM",
"cpuPool" : null,
"numberOfCores" : null
}
```

3. To recover from a backup report, based on SCN, identify the database ID and the backup report for recovery.

In the following example, the JSON input file for the backup report is `backupreport.json`.

```
# odacli recover-database -i b5fc646e-01a6-4c8b-8286-7633346c4 -br
backupreport.json -p
```

4. To recover based on PITR, identify the database ID and the date and time stamp for recovery.

```
# odacli recover-database -i b5fc646e-01a6-4c8b-8286-7633346c4 -t
PITR -r 01/08/2018 12:57:33 -p
```

5. To recover based on SCN, identify the database ID and the SCN number.

```
# odacli recover-database -i b5fc646e-01a6-4c8b-8286-7633346c4 -t
SCN -s 392375947
```

6. To recover based on the latest backup, identify the database ID and use the Latest option.

```
# odacli recover-database -i b5fc646e-01a6-4c8b-8286-7633346c4 -t
Latest -p
```

7. Validate that the job completed. You can track the job in the **Activity** tab in the Browser User Interface, or run the command `odacli describe-job` with the job ID.

```
# odacli describe-job -i jobId
```

When the job completes successfully, the recovery is complete.

Restoring a Database with the CLI

You can restore a database to a system from Oracle Object Storage or NFS backup location using a backup report and the command-line interface.

When you restore a database, environment and validation checks and setup tasks are performed. Restoring a database requires a number of tasks and configuration details, such as creating database storage, Oracle Home, recreating the control file, registering the database, and establishing RMAN restore and recovery. An Oracle Database Appliance backup report is generated for each backup and contains the metadata required to restore a database. The report is designed to help you to quickly and efficiently restore a database.

You can restore a database from one appliance to another appliance, or to the same appliance when the source database is deleted:

- To restore to a different system, copy the backup report generated by the command `odacli create-backup` to the other machine's `\bin` folder and use the command `odacli irestore-database` with the backup report.

- To restore to the same system, delete the source database and use the backup report generated by the command `odacli create-backup`.

To restore a database to another system, you must have a database backup report in Oracle Object Storage, valid credentials in an Oracle wallet (ObjectStoreSwift), the Swift Object Store credential ID, and the SYS user password.

 **Note:**

For Standard Edition Oracle Database 19c or later, you cannot restore Oracle RAC or Oracle RAC One Node Database.

Follow these steps to restore a database using the command-line (CLI):

1. Display a list of backup reports and locate the latest Backup Report in Oracle Object Storage for the database and save the Backup Report ID.

```
# odacli list-backupreports
```

2. Use the Backup Report ID to display the details of the latest Backup Report.

```
# odacli describe-backupreport -i 7fbb06bf-e3a3-4aed-
b617-4d1cd3d33387
{
  "id" : "7fbb06bf-e3a3-4aed-b617-4d1cd3d33387",
  "dbResId" : "4903d18a-6c20-4860-9ed0-d2ea7bd3d7b9",
  "tag" : "auto",
  "dbId" : "3022438697",
  "dbName" : "tdbasml",
  "dbUniqueName" : "tdbasml",
  "backupType" : "regular-10",
  "keepDays" : null,
  "backupLocation" : "https://swiftobjectstorage.us-
ashburn-1.oraclecloud.com/v1/paasdevdbcssi/Bha_Backups",
  "cfBackupHandle" : "c-3022438697-20201022-03",
  "spfBackupHandle" : "c-3022438697-20201022-03",
  "pitrTimeStamp" : "October 22, 2020 07:51:59 AM UTC",
  "pitrSCN" : "2549429",
  "resetLogsTimeStamp" : "October 22, 2020 05:23:56 AM UTC",
  "resetLogsSCN" : "2510142",
  "oraHomeVersion" : "19.8.0.0.200714",
  "sqlPatches" : "31281355",
  "backupLogLoc" : "https://
swiftobjectstorage.us-ashburn-1.oraclecloud.com/v1/paasdevdbcssi/
Bha_Backups/scaoda8s002-c/database/3022438697/tdbasml/rmanlog/
2020-10-22/rman_backup_auto_2020-10-22_07-51-06.0546.log",
  "tdeWalletLoc" : "https://
swiftobjectstorage.us-ashburn-1.oraclecloud.com/v1/paasdevdbcssi/
TestLtBackupFailur/scaoda8s002-c/database/3022438697/tdbasml/
tdewallet/ewallet_2020102207525186_tdbasml.pl2",
  "dbConfigLoc" : "https://
swiftobjectstorage.us-ashburn-1.oraclecloud.com/v1/paasdevdbcssi/
Bha_Backups/scaoda8s002-c/database/3022438697/tdbasml/dbconfig/
```



```

2020-10-22/DBCONFIG_auto_2020-10-22_07-52-43.0230.tar.gz",
  "name" : "Backup_Report_tdbasm1",
  "createTime" : "October 22, 2020 07:51:03 AM UTC",
  "state" : {
    "status" : "CONFIGURED"
  },
  "updatedAtTime" : "October 22, 2020 07:52:55 AM UTC",
  "backupReportLogDetail" : "https://swiftobjectstorage.us-ashburn-1.oraclecloud.com/v1/paasdevdbcssi/Bha_Backups/scaoda8s002-c/database/3022438697/tdbasml/rmandetaillogreport/2020-10-22/rman_list_backup_detail_auto_2020-10-22_07-52-33.0919.log",
  "dbInfo" : {
    "dbClass" : "OLTP",
    "dbType" : "SI",
    "dbShape" : "odbl",
    "dbEdition" : "EE",
    "dbStorage" : "ASM",
    "dbRedundancy" : null,
    "pdbName" : null,
    "isCdb" : false
  },
  "dbDataSize" : "1662M",
  "dbRedoSize" : "12298M",
  "rmanBackupPieces" :
  "https://swiftobjectstorage.us-ashburn-1.oraclecloud.com/v1/paasdevdbcssi/Bha_Backups/scaoda8s002-c/database/3022438697/tdbasml/backuppieces/2020-10-22/backupPieces_auto_4903d18a-6c20-4860-9ed0-d2ea7bd3d7b9_20201022075238.json",
  "compressionAlgo" : "MEDIUM",
  "cpuPool" : null,
  "numberOfCores" : null
}

```

3. (Optional) If you need to generate a new backup report, use the command `odacli create-backup`.

```
# odacli create-backup
```

4. Locate the Swift Object Store credential ID for the database backup.

```
# odacli list-objectstoreswifts
```

5. Save the backup report as a JSON file in a folder in the `\bin` directory on the appliance. For example, `backupreport.json`.
6. Restore the database to the system using the JSON file in the command `odacli irestore-database`.

Run the command, then enter the SYS user password when prompted.

```
# odacli irestore-database -r backupreport.json -oid Object Store ID -m
```

To restore a TDE-enabled database, the TDE wallet password must be provided. If source database is TDE enabled, then the target database which was restored will also have TDE enabled.

7. Validate that the job completed. You can track the job in the **Activity** tab in the Browser User Interface, or run the command `odacli describe-job` with the job ID.

```
# odacli describe-job -i jobId
```

Restoring Archivelog with the CLI

You can restore archivelog from one SCN to another SCN, or from one timestamp to another timestamp using the command-line interface.

Follow these steps to restore archivelog using the command-line (CLI):

- Restore archivelog from one SCN to another SCN, or from one timestamp to another timestamp:

```
# odacli restore-archivelog -fs from_scn -ts to_scn
# odacli restore-archivelog -ft from_timestamp -tt to_timestamp
```

Deleting Backups with the CLI

Delete older, obsolete level 0, level 1 and long term backups.

For level 0 and level 1 backups, the recovery window defined in the Backup Configuration determines when the backup is obsolete. The ranges are as follows:

- Backup to disk: between 1 and 14 days
- Backup to the Oracle Object Storage: between 1 and 31 days

For Long Term backups to the Oracle Object Storage, view the Backup Report for a database to determine when the backup is obsolete. To delete Long Term Backup, the Database Resource ID or Database name and the Backup Report are required.

Follow these steps to delete database backups using `odacli` commands:

1. Display a list of all backup reports.

```
# odacli list-backupreports
```

2. Obtain the Database ID and type of backup.

```
# odacli describe-backupreport -i Backup Report ID
```

3. To delete obsolete level 0 and level 1 backups, use the Database ID or Database Name to delete the backup.

```
# odacli delete-backup -i 20576eb1-bc32-4e34-bf97-fda0b60ca15b
```

4. To delete Long Term backups, use the Backup Report and a JSON file to delete the backup.

In the following example, the JSON input file for the backup report is
backupreport.json.

```
# odacli delete-backup -i 20576eb1-bc32-4e34-bf97-fda0b60ca15b -br  
backupreport.json
```

11

Using Oracle Data Guard for Disaster Management and Recovery on Oracle Database Appliance

Understand how you can use Oracle Data Guard for disaster management and recovery on Oracle Database Appliance.

- [About Oracle Data Guard on Oracle Database Appliance](#)
Oracle Database Appliance provides client interface through ODACLI commands for easy configuration and management of Oracle Data Guard for high availability, data protection, and disaster recovery.
- [Configuring Oracle Data Guard on Oracle Database Appliance](#)
Oracle Database Appliance enables you to set up Oracle Data Guard using ODACLI commands.
- [Viewing Oracle Data Guard Status on Oracle Database Appliance](#)
View Oracle Data Guard status using ODACLI commands.
- [Performing Oracle Data Guard Operations](#)
Perform failover, switchover, and reinstate operations on Oracle Data Guard using ODACLI commands.
- [Creating an Oracle Data Guard Network](#)
Create an Oracle Data Guard network and associate it with a database using ODACLI commands.
- [Migrating an Oracle Data Guard Database from One System to Another](#)
You can migrate Oracle Data Guard databases using ODACLI commands.
- [Patching Oracle Data Guard Databases on Oracle Database Appliance](#)
Understand how you can patch primary and standby databases on Oracle Data Guard using ODACLI commands.
- [Upgrading Oracle Data Guard Databases on Oracle Database Appliance](#)
Understand how you can upgrade primary and standby databases on Oracle Data Guard using ODACLI commands.
- [Enabling Oracle Active Data Guard on Existing Configurations](#)
Understand how you can enable Oracle Active Data Guard on existing configurations.
- [Deconfiguring Oracle Data Guard on Oracle Database Appliance](#)
Deconfigure Oracle Data Guard status using ODACLI commands.

About Oracle Data Guard on Oracle Database Appliance

Oracle Database Appliance provides client interface through ODACLI commands for easy configuration and management of Oracle Data Guard for high availability, data protection, and disaster recovery.

Oracle Data Guard provides a comprehensive set of services that create, maintain, manage, and monitor one or more standby databases to enable production Oracle databases to survive disasters and data corruptions. Oracle Data Guard maintains these standby databases as copies of the production database. Then, if the production database becomes unavailable because of a planned or an unplanned outage, Oracle Data Guard can switch any standby database to the production role, minimizing the downtime associated with the outage. Oracle Data Guard can be used with traditional backup, restoration, and cluster techniques to provide a high level of data protection and data availability. Oracle Data Guard transport services are also used by other Oracle features such as Oracle Streams and Oracle GoldenGate for efficient and reliable transmission of redo from a source database to one or more remote destinations.

With Oracle Data Guard, administrators can optionally improve production database performance by offloading resource-intensive backup and reporting operations to standby systems.

The ability to create clone databases on a standby system enables you to set up test or development environments based on your standby databases. Since standby systems are not production systems, they are a better choice for seeding test or development environments.

**Note:**

Oracle Database Enterprise Edition includes Oracle Data Guard.

Configuring Oracle Data Guard on Oracle Database Appliance

Oracle Database Appliance enables you to set up Oracle Data Guard using ODACLI commands.

Prerequisites for Oracle Database Guard Configuration

Before you begin:

- Oracle recommends running the primary and the standby databases on separate Oracle Database Appliance hardware, so ensure that you have at least two separate Oracle Database Appliance machines.
- Oracle recommends running the primary and the standby databases on two homogeneous Oracle Database Appliance systems. For example, if the primary database is a High-Availability system, then the standby database must be on a similar High-Availability system.
- Oracle recommends that the primary and standby systems have the same Oracle Database Appliance configuration. The database must have similar configuration for database shape, version, memory, networking, and storage (both must have either Oracle ASM or Oracle ACFS storage) to avoid any unpredictability with the database switch roles.
- The primary and standby systems must be the same Oracle Database Appliance release, and must be on Oracle Database Appliance release 19.8 or later.

- If you have customized the operating system, then ensure that environments on both machines are identical.
- Ensure that your deployment follows Oracle Maximum Availability Architecture (MAA) best practices. See the Oracle Maximum Availability Architecture (MAA) page on Oracle Technology Network.
- If you decide to use Oracle ObjectStore for backup and recovery, then you must configure access for both the primary and standby systems.

Setting up Backup and Recovery for Oracle Database Guard Configuration

You can use either Object Store or External FRA (NFS) to set up the backup for primary and standby databases when configuring Oracle Data Guard on Oracle Database Appliance. A backup is necessary to instantiate a standby database.

To set up Object Store backup (recommended):

1. Configure the agent proxy settings:

```
# odacli update-agentConfigParameters -n HttpProxyHost -v www-
proxy.test.com -n HttpProxyPort -v 80 -u
```

For more information, see the topic *Configuring Agent Proxy Settings for Object Store Access* in this guide.

2. Create the Object Store credentials on both primary and standby systems:

```
# odacli create-objectstoreswift -e swift_end_point_URL -
n Object_Store_Swift_name -t Object_Store_tenant_name -u
Object_Store_user_name
```

For example:

```
# odacli create-objectstoreswift -e https://swiftobjectstorage.us-
ashburn-1.oraclecloud.com/v1 -n aaa -t test_user -u testuser
```

3. View the Object Store Swift name:

```
# odacli list-objectstoreswifts
```

4. Create the backup configuration:

```
# odacli create-backupconfig -d objectstore -c testuser -on aaa -w
7 -cr -n backupConfig7days
```

5. Associate the backup configuration with the database:

```
# odacli modify-database -in test_db -bin backupConfig7days -bp
```

To set up NFS backup:

1. Create the backup configuration. For High-Availability deployments, run the command on one node only.

```
# odacli create-backupconfig -n nfsbkup -w 10 -d NFS -c /u01/
nfs_backup
```

2. Associate the backup configuration with the database:

```
# odacli modify-database -in test_db -bin nfsbkup
```

Configuring Oracle Data Guard using ODACLI commands

Follow these steps:

1. Take a backup of your primary database to Object Store or External FRA (NFS) with the `-ka` option to keep archivelogs after backup.

```
# odacli create-backup --backupType Regular-L0 -in primary_DB -ka
```

For example:

```
# odacli create-backup --backupType Regular-L0 -in test_db -ka
```

2. Save the backup report:

```
# odacli describe-backupreport -i eba406c7-ae46-4d1d-
ale5-3e985397b171 > backup_report_test_db_0620.json
```

The backup report ID is the ID of the backup created in step 1 and can be obtained by running the `odacli list-backupreports` command.

3. Copy the backup report to the standby system and restore the backup to a standby database.

```
# odacli irestore-database -ro STANDBY
```

If you want to use Object Store, then specify the Object Store location:

```
# odacli irestore-database -r backup_report.json -u dbUniqueName
-on objectStoreName -bp -ro STANDBY
Rman Backup Encryption Password(s). Multiple passwords needs to be
comma separated.:
Password for SYS user:
```

In the above command, specify the `dbUniqueName` of the standby system.

If your backup option is NFS, then specify the NFS location:

```
odacli irestore-database -r backup_report.json -u dbUniqueName -ro
STANDBY
Password for SYS user:
```

4. Configure Oracle Data Guard, by running the `odacli configure-dataguard` command on the primary system. Provide the values for your configuration through the interactive command line interface.

In the interactive CLI configuration steps, the parameters are as follows:

- Standby site address is IP address or host name of the standby host. Provide the fully qualified domain name and hostname if the primary and the standby systems are in the same domain and DNS is configured.
- Select Oracle Data Guard protection modes to meet availability, performance and data protection requirements. Oracle Data Guard Protection Modes are Maximum Availability, Maximum Performance, and Maximum Protection. The log transport modes are ASYNC, SYNC, and FASTSYNC. You can select the following combinations of protection modes and transport types:

Table 11-1 Oracle Data Guard protection modes and transport modes

Protection Mode \ Transport Type	ASYNC	FASTSYNC**	SYNC
MAXPERFORMANCE	Y*	Y	Y
MAXAVAILABILITY	N	Y	Y*
MAXPROTECTION	N	N	Y*

* in the table indicates the default supported pair and ** FASTSYNC mode is available only in Oracle Database 12.1 or later.

```
# odacli configure-dataguard
Standby site address: test_domain
root@test_domain's password:
BUI username for Standby site (default: oda-admin):
BUI password for Standby site:
Database name for Data Guard configuration: test_db
Primary database syspassword:
*****
*****
Data Guard default settings
Primary site network for Data Guard configuration: Public-network
Standby site network for Data Guard configuration: Public-network
Primary database listener port: 1521
Standby database listener port: 1521
Transport type: ASYNC
Protection mode: MAX_PERFORMANCE
Data Guard configuration name: test_dg
Active Data Guard: disabled
Do you want to edit this Data Guard configuration? (Y/N, default:N):
As a requirement, Standby database's SYS password will be set to
Primary database's after Data Guard configuration. Are you sure you
want to proceed with Data Guard configuration? (Y/N): y
*****
*****
Configure Data Guard test_dg started
*****
*****
```



```
Step 1: Validate Data Guard configuration request (Primary site)
Description: Validate DG Config Creation for db test_db
Job ID: 523a38ac-e641-46e2-bf38-ecfb641e5dc9
Started December 08, 2020 21:08:59 PM UTC
Validate create Data Guard configuration request
Finished December 08, 2020 21:09:02 PM UTC
*****
*****

Step 2: Validate Data Guard configuration request (Standby site)
Description: Validate DG Config Creation for db test_db
Job ID: 712843f9-65ca-4aea-95eb-4e5c461f3672
Started December 08, 2020 21:09:03 PM UTC
Validate create Data Guard configuration request
Finished December 08, 2020 21:09:05 PM UTC
*****
*****

Step 3: Download password file from Primary database (Primary site)
Description: Download orapwd file from Primary database
Started December 08, 2020 21:09:05 PM UTC
Prepare orapwd file for Primary database test_db
Finished December 08, 2020 21:09:10 PM UTC
*****
*****

Step 4: Upload password file to Standby database (Standby site)
Description: Upload orapwd file to Standby database
Started December 08, 2020 21:09:10 PM UTC
Write orapwd file to Standby database test_db
Finished December 08, 2020 21:09:19 PM UTC
*****
*****

Step 5: Configure Primary database (Primary site)
Description: DG Config service for db test_db - ConfigurePrimary
Job ID: ad8486a2-bea6-47ff-a8ab-330be98987ab
Started December 08, 2020 21:09:19 PM UTC
Configure host DNS on primary env
Configure Data Guard Tns on primary env
Enable Data Guard related Db parameters for primary env
Enable force logging and archivelog mode in primary env
Enable FlashBack
Configure network parameters for local listener on primary env
Restart listener on primary env
Create services for primary db
Finished December 08, 2020 21:09:35 PM UTC
*****
*****

Step 6: Configure Standby database (Standby site)
Description: DG Config service for db test_db - ConfigureStandby
Job ID: 47876bb8-8fef-41a6-a0b6-92b184c74900
Started December 08, 2020 21:09:37 PM UTC
Configure Data Guard Tns on standby env
Configure host DNS on standby env
Clear Data Guard related Db parameters for standby env
Enable Data Guard related Db parameters for standby env
Enable force logging and archivelog mode in standby env
Populate standby database metadata
```

```
Configure network parameters for local listener on standby env
Reset Db sizing and hidden parameters for ODA best practice
Restart Listener on standby env
Create services for standby db
Finished December 08, 2020 21:11:02 PM UTC
*****
*****
Step 7: Configure and enable Data Guard (Primary site)
Description: DG Config service for db test_db - ConfigureDg
Job ID: 64674e50-3eea-48d0-a25e-bc61401a3d71
Started December 08, 2020 21:11:02 PM UTC
Config and enable Data Guard
Post check Data Guard configuration
Finished December 08, 2020 21:12:21 PM UTC
*****
*****
Step 8: Enable Flashback (Standby site)
Description: DG Config service for db test_db - EnableFlashback
Job ID: 6f461b2f-88e1-41bf-9ca8-d91bc7d4bf97
Started December 08, 2020 21:12:22 PM UTC
Enable FlashBack
Finished December 08, 2020 21:12:33 PM UTC
*****
*****
Step 9: Re-enable Data Guard (Primary site)
Description: DG Config service for db test_db - ReenableDg
Job ID: 3a4a404d-e1b5-4c4e-9db1-545676eebc77
Started December 08, 2020 21:12:34 PM UTC
Re-enable Data Guard if inconsistent properties found
Post check Data Guard configuration
Finished December 08, 2020 21:12:36 PM UTC
*****
*****
Step 10: Create Data Guard status (Primary site)
Description: DG Status service for db test_db - NewDgconfig
Job ID: 572dea8d-5682-4193-a984-0aebb072be45
Started December 08, 2020 21:12:36 PM UTC
Create Data Guard status
Finished December 08, 2020 21:12:39 PM UTC
*****
*****
Step 11: Create Data Guard status (Standby site)
Description: DG Status service for db test_db - NewDgconfig
Job ID: 75e55d7f-49c3-4e2d-8907-a7130cc05034
Started December 08, 2020 21:12:40 PM UTC
Create Data Guard status
Finished December 08, 2020 21:12:41 PM UTC
*****
*****
Configure Data Guard test_dg completed
*****
*****
```

Example with Oracle Data Guard custom configuration:

```
# odacli configure-dataguard
Standby site address: test_domain
root@test_db's password:
BUI username for Standby site (default: oda-admin):
BUI password for Standby site:
Database name for Data Guard configuration: test_db
Primary database syspassword:
*****
*****
Data Guard default settings
Primary site network for Data Guard configuration: Public-network
Standby site network for Data Guard configuration: Public-network
Primary database listener port: 1521
Standby database listener port: 1521
Transport type: ASYNC
Protection mode: MAX_PERFORMANCE
Data Guard configuration name: test_dg
Active Data Guard: disabled
Do you want to edit this Data Guard configuration? (Y/N,
default:N): y
*****
*****
Primary site network for Data Guard configuration [Public-network]
(default: Public-network):
Standby site network for Data Guard configuration [Public-network]
(default: Public-network):
Primary database listener port (default: 1521):
Standby database listener port (default: 1521):
Transport type [ASYNC, FASTSYNC, SYNC] (default: ASYNC): SYNC
Protection mode [MAX_PROTECTION, MAX_PERFORMANCE, MAX_AVAILABILITY]
(default: MAX_PERFORMANCE): MAX_PROTECTION
Data Guard configuration name (default: pcpub_scpub): custom_test_dg
Enable Active Data Guard? (Y/N, default:N): y
The TrustStore of the Standby site should be removed unless it is
necessary for some other purpose. Do you
As a requirement, Standby database's SYS password will be set to
Primary database's after Data Guard configuration. Are you sure you
want to proceed with Data Guard configuration? (Y/N): y
*****
*****
Configure Data Guard custom_test_dg started
*****
*****
Step 1: Validate Data Guard configuration request (Primary site)
Description: Validate DG Config Creation for db test_db
Job ID: 523a38ac-e641-46e2-bf38-ecfb641e5dc9
Started December 08, 2020 21:08:59 PM UTC
Validate create Data Guard configuration request
Finished December 08, 2020 21:09:02 PM UTC
*****
*****
Step 2: Validate Data Guard configuration request (Standby site)
Description: Validate DG Config Creation for db test_db
```

```

Job ID: 712843f9-65ca-4aea-95eb-4e5c461f3672
Started December 08, 2020 21:09:03 PM UTC
Validate create Data Guard configuration request
Finished December 08, 2020 21:09:05 PM UTC
*****
*****
Step 3: Download password file from Primary database (Primary site)
Description: Download orapwd file from Primary database
Started December 08, 2020 21:09:05 PM UTC
Prepare orapwd file for Primary database test_db
Finished December 08, 2020 21:09:10 PM UTC
*****
*****
Step 4: Upload password file to Standby database (Standby site)
Description: Upload orapwd file to Standby database
Started December 08, 2020 21:09:10 PM UTC
Write orapwd file to Standby database test_db
Finished December 08, 2020 21:09:19 PM UTC
*****
*****
Step 5: Configure Primary database (Primary site)
Description: DG Config service creation for db test_db -
ConfigurePrimary
Job ID: ad8486a2-bea6-47ff-a8ab-330be98987ab
Started December 08, 2020 21:09:19 PM UTC
Configure host DNS on primary env
Configure Data Guard Tns on primary env
Enable Data Guard related Db parameters for primary env
Enable force logging and archivelog mode in primary env
Enable FlashBack
Configure network parameters for local listener on primary env
Restart listener on primary env
Create services for primary db
Finished December 08, 2020 21:09:35 PM UTC
*****
*****
Step 6: Configure Standby database (Standby site)
Description: DG Config service creation for db test_db -
ConfigureStandby
Job ID: 47876bb8-8fef-41a6-a0b6-92b184c74900
Started December 08, 2020 21:09:37 PM UTC
Configure Data Guard Tns on standby env
Configure host DNS on standby env
Clear Data Guard related Db parameters for standby env
Enable Data Guard related Db parameters for standby env
Enable force logging and archivelog mode in standby env
Populate standby database metadata
Configure network parameters for local listener on standby env
Reset Db sizing and hidden parameters for ODA best practice
Restart Listener on standby env
Create services for standby db
Finished December 08, 2020 21:11:02 PM UTC
*****
*****
Step 7: Configure and enable Data Guard (Primary site)

```

```
Description: DG Config service creation for db test_db - ConfigureDg
Job ID: 64674e50-3eea-48d0-a25e-bc61401a3d71
Started December 08, 2020 21:11:02 PM UTC
Config and enable Data Guard
Post check Data Guard configuration
Finished December 08, 2020 21:12:21 PM UTC
*****
*****
Step 8: Enable Flashback (Standby site)
Description: DG Config service creation for db test_db -
EnableFlashback
Job ID: 6f461b2f-88e1-41bf-9ca8-d91bc7d4bf97
Started December 08, 2020 21:12:22 PM UTC
Enable FlashBack
Finished December 08, 2020 21:12:33 PM UTC
*****
*****
Step 9: Re-enable Data Guard (Primary site)
Description: DG Config service creation for db test_db - ReenableDg
Job ID: 3a4a404d-e1b5-4c4e-9db1-545676eebc77
Started December 08, 2020 21:12:34 PM UTC
Re-enable Data Guard if inconsistent properties found
Post check Data Guard configuration
Finished December 08, 2020 21:12:36 PM UTC
*****
*****
Step 10: Enable Active Data Guard (Standby site)
Description: DG Config service creation for db test_db -
EnableActivedg
Job ID: 3117c046-2d71-453d-9950-c85bed19f5f2
Started December 08, 2020 21:12:38 PM UTC
Started
Open standby db
Restart standby db
Finished December 08, 2020 21:12:45 PM UTC
*****
*****
Step 11: Create Data Guard status (Primary site)
Description: DG Status service creation for db test_db - NewDgconfig
Job ID: 572dea8d-5682-4193-a984-0aebb072be45
Started December 08, 2020 21:12:46 PM UTC
Create Data Guard status
Finished December 08, 2020 21:12:49 PM UTC
*****
*****
Step 12: Create Data Guard status (Standby site)
Description: DG Status service creation for db test_db - NewDgconfig
Job ID: 75e55d7f-49c3-4e2d-8907-a7130cc05034
Started December 08, 2020 21:12:52 PM UTC
Create Data Guard status
Finished December 08, 2020 21:12:55 PM UTC
*****
*****
Configure Data Guard custom_test_dg completed
```

```
*****
*****
```

You can also specify a JSON file to configure Oracle Data Guard. An example JSON file is described in this topic.

```
# odacli configure-dataguard -r configdg_ODA_HA.json
Standby machine address: test_domain
BUI username for Standby machine (default: oda-admin):
BUI password for Standby machine:
Primary database syspassword:
As a requirement, Standby database's SYS password will be set to
Primary database's after Data Guard configuration. Are you sure you
want to proceed? (Y/N): y
Data Guard configuration for database 'test' started
*****
*****
Step 1: Validate Data Guard configuration request (Primary machine)
.....
```

For more information about these command options, see the *Oracle Database Appliance Command Line Reference* chapter in this guide.

Example JSON for configuring Oracle Data Guard on Oracle Database Appliance

```
{
  "name": "test1_test7",
  "protectionMode": "MAX_PERFORMANCE",
  "enableFlashback": true,
  "enableActiveDg": false,
  "replicationGroups": [
    {
      "sourceEndpoints": [
        {
          "endpointType": "PRIMARY",
          "hostName": "test_domain1",
          "listenerPort": 1521,
          "databaseUniqueName": "test1",
          "ipAddress": "test_IPaddress"
        }
      ],
      {
        "endpointType": "PRIMARY",
        "hostName": "test_domain1",
        "listenerPort": 1521,
        "databaseUniqueName": "test1",
        "ipAddress": "test_IPaddress2"
      }
    ],
    "targetEndpoints": [
      {
        "endpointType": "STANDBY",
        "hostName": "test_domain2",
        "listenerPort": 1521,
        "databaseUniqueName": "test7",
```

```

        "ipAddress": "test_IPaddress3"
      },
      {
        "endpointType": "STANDBY",
        "hostName": "test_domain2",
        "listenerPort": 1521,
        "databaseUniqueName": "test7",
        "ipAddress": "test_IPaddress4"
      }
    ],
    "transportType": "ASYNC"
  }
]
}

```

Related Topics

- [Configuring Agent Proxy Settings for Object Store Access](#)
If the Object Store IP address is accessible only through proxy setup by the Oracle Database Appliance server, then define the proxy setting for the agent, so that the agent can access the Object Store.
- <https://www.oracle.com/in/database/technologies/high-availability/maa.html>

Viewing Oracle Data Guard Status on Oracle Database Appliance

View Oracle Data Guard status using ODACLI commands.

Viewing Oracle Data Guard Status using ODACLI commands

Follow these steps:

- To view the status of primary and standby databases in your Oracle Data Guard configuration, use the following command:

```
# odacli list-dataguardstatus
```

- To view the status of your specific Oracle Data Guard configuration, use the following command:

```
# odacli describe-dataguardstatus -i 5f0ed48a-366d-454c-a389-
fe367772dbb7
```

For more information about these command options, see the *Oracle Database Appliance Command Line Reference* chapter in this guide.

Related Topics

- [Oracle Data Guard odacli Commands](#)
Use ODACLI commands to configure and manage Oracle Data Guard in your Oracle Database Appliance deployment.

Performing Oracle Data Guard Operations

Perform failover, switchover, and reinstate operations on Oracle Data Guard using ODACLI commands.

Performing Oracle Data Guard operations using ODACLI commands

Follow these steps:

- To switch roles between the primary database and standby database in your Oracle Data Guard configuration, run the following command on the **primary** system:

```
# odacli switchover-dataguard -i dg_ID -u  
standby_db_unique_name_to_switchover
```

For example:

```
# odacli switchover-dataguard -i 75f23ce0-006a-4aeb-ba6d-  
b4b60275c19 -u test_db2
```

Confirm that the switchover of roles completed successfully:

```
# odacli describe-dataguardstatus -i 75f23ce0-006a-4aeb-ba6d-  
b4b60275c19
```

- A failover provides for transitioning a standby database in your configuration to take over the primary database role, if all instances of an Oracle RAC primary database fail, or are unreachable.
To failover a standby database to the primary database in your Oracle Data Guard configuration, run the following command on your current **standby** system:

```
# odacli failover-dataguard -i dg_ID -u  
standby_db_unique_name_to_failover_to
```

For example:

```
# odacli failover-dataguard -i 75f23ce0-006a-4aeb-ba6d-b4b60275c19  
-u test_db2
```

Confirm that the requested database failover to the new primary database has completed successfully:

```
# odacli describe-dataguardstatus -i 75f23ce0-006a-4aeb-ba6d-  
b4b60275c19
```

- To reinstate a failed primary database after a failover and convert it to a new standby database in your Oracle Data Guard configuration, run the following command on your new primary system:

```
# odacli reinstate-dataguard -i dg_ID -u db_unique_name_to_reinstate
```

For example:

```
# odacli reinstate-dataguard -i 75f23ce0-006a-4aeb-ba6d-b4b60275c19
-u test_db2
```

Confirm that the requested database is reinstated as a new standby database:

```
# odacli describe-dataguardstatus -i 75f23ce0-006a-4aeb-ba6d-
b4b60275c19
```

For more information about these command options, see the *Oracle Database Appliance Command Line Reference* chapter in this guide.

Related Topics

- [Oracle Data Guard odacli Commands](#)
Use ODACLI commands to configure and manage Oracle Data Guard in your Oracle Database Appliance deployment.

Creating an Oracle Data Guard Network

Create an Oracle Data Guard network and associate it with a database using ODACLI commands.

Configuring an Oracle Data Guard Network using ODACLI commands

You can configure Oracle Data Guard using a network of type Public, Database, or Dataguard.

Follow these steps:

1. Create the network:

```
# odacli create-network -n btbond1 -t VLAN -p 192.209.10.227 -w
Dataguard -no-d -s 255.255.255.240 -v 369 -g 192.209.10.225
```

2. View the new network:

```
# odacli list-networks
```

```
ID                               Name
NIC      Interface Type  Subnet Mask      Gateway
VLAN ID  Node Networks
-----
836cfa4b-5d2c-45e3-a62d-099fc7c57984  Private-network
priv0      INTERNAL      255.255.255.240  [ IP Address on
```

```

node0: 192.168.16.24 ]
1a312239-761d-4321-84d2-8da406f21e5c Public-network
btbond1.359 VLAN 255.255.255.240 10.209.10.65
359 [ IP Address on node0: 192.209.10.69 ]
f279ac96-5a4a-4b73-86af-1afb6ae5d4 vlan369
btbond1.369 VLAN 255.255.255.240 10.209.10.225
369 [ IP Address on node0: 192.209.10.227 ]

```

3. To attach a network of type Dataguard to a database:

```
# odacli modify-database -in test_db -an vlan369
```

For more information about these command options, see the *Oracle Database Appliance Command Line Reference* chapter in this guide.

Related Topics

- [Oracle Data Guard odacli Commands](#)
Use ODACLI commands to configure and manage Oracle Data Guard in your Oracle Database Appliance deployment.

Migrating an Oracle Data Guard Database from One System to Another

You can migrate Oracle Data Guard databases using ODACLI commands.

Migrating Oracle Data Guard Database using ODACLI commands

If your database is on an old Oracle Database Appliance hardware model, and you want to move your deployment to a new Oracle Database Appliance hardware, then you can use your Oracle Data Guard configuration on Oracle Database Appliance to migrate from one system to another.

Before you begin:

- Oracle recommends running the primary and the standby databases on separate Oracle Database Appliance hardware, so ensure that you have at least two separate Oracle Database Appliance machines.
- The primary and standby systems must be the same Oracle Database Appliance release, and must be on Oracle Database Appliance release 19.8 or later. The instances on the primary and standby databases must have similar configuration for database parameter settings including database version, memory, CPU, networking, and storage (Oracle ASM or Oracle ACFS), thus avoiding any unpredictability when the databases switch roles.
- If you have customized the operating system, then ensure that environments on both machines are identical.
- Ensure that your deployment follows Oracle Maximum Availability Architecture (MAA) best practices.

Follow these steps:

1. Take a backup of your primary database to Object Store or External FRA (NFS) with the option to keep archivelogs enabled.

```
# odacli create-backup primary_DB -ka
```

For example:

```
# odacli create-backup --backupType Regular-L0 -in test_db -ka
```

2. Save the backup report:

```
# odacli describe-backupreport -i eba406c7-ae46-4d1d-
a1e5-3e985397b171 > backup_report_test_db_0620.json
```

The backup report ID is the ID of the backup created in step 1 and can be obtained by running the `odacli list-backupreports` command.

3. Copy the backup report to the standby system and restore the backup to a standby database.

```
# odacli irestore-database -ro STANDBY
```

If your backup option is Object Store, then specify the Object Store location:

```
# odacli irestore-database -r backup_report.json -u dbUniqueName
-on objectStoreName -bp -ro STANDBY -dh
Password for SYS user:
Rman Backup Encryption Password(s). Multiple passwords needs to be
comma separated.:
```

If your backup option is NFS, then specify the NFS location:

```
odacli irestore-database -r backup_report.json -u dbUniqueName -ro
STANDBY
Password for SYS user:
```

4. Configure Oracle Data Guard, by running the following command on the primary system:

```
# odacli configure-dataguard
Standby site address: test_domain
root@test_domain's password:
BUI username for Standby site (default: oda-admin):
BUI password for Standby site:
Database name for Data Guard configuration: test_db
Primary database syspassword:
*****
*****
Data Guard default settings
Primary site network for Data Guard configuration: Public-network
Standby site network for Data Guard configuration: Public-network
Primary database listener port: 1521
```

```
Standby database listener port: 1521
Transport type: ASYNC
Protection mode: MAX_PERFORMANCE
Data Guard configuration name: test_dg
Active Data Guard: disabled
Do you want to edit this Data Guard configuration? (Y/N, default:N):
As a requirement, Standby database's SYS password will be set to
Primary database's after Data Guard configuration. Are you sure you
want to proceed with Data Guard configuration? (Y/N): y
*****
*****
Configure Data Guard test_dg started
*****
*****
Step 1: Validate Data Guard configuration request (Primary site)
Description: Validate DG Config Creation for db test_db
Job ID: 523a38ac-e641-46e2-bf38-ecfb641e5dc9
Started December 08, 2020 21:08:59 PM UTC
Validate create Data Guard configuration request
Finished December 08, 2020 21:09:02 PM UTC
*****
*****
Step 2: Validate Data Guard configuration request (Standby site)
Description: Validate DG Config Creation for db test_db
Job ID: 712843f9-65ca-4aea-95eb-4e5c461f3672
Started December 08, 2020 21:09:03 PM UTC
Validate create Data Guard configuration request
Finished December 08, 2020 21:09:05 PM UTC
*****
*****
Step 3: Download password file from Primary database (Primary site)
Description: Download orapwd file from Primary database
Started December 08, 2020 21:09:05 PM UTC
Prepare orapwd file for Primary database test_db
Finished December 08, 2020 21:09:10 PM UTC
*****
*****
Step 4: Upload password file to Standby database (Standby site)
Description: Upload orapwd file to Standby database
Started December 08, 2020 21:09:10 PM UTC
Write orapwd file to Standby database test_db
Finished December 08, 2020 21:09:19 PM UTC
*****
*****
Step 5: Configure Primary database (Primary site)
Description: DG Config service creation for db test_db -
ConfigurePrimary
Job ID: ad8486a2-bea6-47ff-a8ab-330be98987ab
Started December 08, 2020 21:09:19 PM UTC
Configure host DNS on primary env
Configure Data Guard Tns on primary env
Enable Data Guard related Db parameters for primary env
Enable force logging and archivelog mode in primary env
Enable FlashBack
Configure network parameters for local listener on primary env
```

```

Restart listener on primary env
Create services for primary db
Finished December 08, 2020 21:09:35 PM UTC
*****
*****
Step 6: Configure Standby database (Standby site)
Description: DG Config service creation for db test_db -
ConfigureStandby
Job ID: 47876bb8-8fef-41a6-a0b6-92b184c74900
Started December 08, 2020 21:09:37 PM UTC
Configure Data Guard Tns on standby env
Configure host DNS on standby env
Clear Data Guard related Db parameters for standby env
Enable Data Guard related Db parameters for standby env
Enable force logging and archivelog mode in standby env
Populate standby database metadata
Configure network parameters for local listener on standby env
Reset Db sizing and hidden parameters for ODA best practice
Restart Listener on standby env
Create services for standby db
Finished December 08, 2020 21:11:02 PM UTC
*****
*****
Step 7: Configure and enable Data Guard (Primary site)
Description: DG Config service creation for db test_db - ConfigureDg
Job ID: 64674e50-3eea-48d0-a25e-bc61401a3d71
Started December 08, 2020 21:11:02 PM UTC
Config and enable Data Guard
Post check Data Guard configuration
Finished December 08, 2020 21:12:21 PM UTC
*****
*****
Step 8: Enable Flashback (Standby site)
Description: DG Config service creation for db test_db -
EnableFlashback
Job ID: 6f461b2f-88e1-41bf-9ca8-d91bc7d4bf97
Started December 08, 2020 21:12:22 PM UTC
Enable FlashBack
Finished December 08, 2020 21:12:33 PM UTC
*****
*****
Step 9: Re-enable Data Guard (Primary site)
Description: DG Config service creation for db test_db - ReenableDg
Job ID: 3a4a404d-e1b5-4c4e-9db1-545676eebc77
Started December 08, 2020 21:12:34 PM UTC
Re-enable Data Guard if inconsistent properties found
Post check Data Guard configuration
Finished December 08, 2020 21:12:36 PM UTC
*****
*****
Step 10: Create Data Guard status (Primary site)
Description: DG Status service creation for db test_db - NewDgconfig
Job ID: 572dea8d-5682-4193-a984-0aebb072be45
Started December 08, 2020 21:12:36 PM UTC
Create Data Guard status

```

```

Finished December 08, 2020 21:12:39 PM UTC
*****
*****
Step 11: Create Data Guard status (Standby site)
Description: DG Status service creation for db test_db - NewDgconfig
Job ID: 75e55d7f-49c3-4e2d-8907-a7130cc05034
Started December 08, 2020 21:12:40 PM UTC
Create Data Guard status
Finished December 08, 2020 21:12:41 PM UTC
*****
*****
Configure Data Guard test_dg completed
*****
*****

```

5. Check the status of Oracle Data Guard and ensure it is working:

```
# odacli describe-dataguardstatus
```

6. Switch over to the standby database:

```
# odacli switchover-dataguard -i 75f23ce0-006a-4aeb-ba6d-
b4b60275c19 -u houdg02
```

7. Deconfigure Oracle Data Guard. The process also deletes the standby database on the old Oracle Database Appliance hardware machine.

```

# odacli deconfigure-dataguard -i 8396aac4-f7e7-42e4-
a2e8-0cbbc89ce31b
Standby site address: test_domain
root@test_domain's password:
BUI username for Standby site (default: oda-admin):
BUI password for Standby site:
Standby database will be deleted after Data Guard configuration is
removed. Are you sure you want to proceed? (Y/N): y
Deconfigure Dataguard Started
*****
*****
Step 1: Deconfigure Data Guard (Primary site)
Description: Deconfigure DG service
Job ID: d181fa4b-5bc9-431f-8f83-75ff44c934ff
Started December 09, 2020 18:59:17 PM UTC
Deconfigure Data Guard service
Cleanup broker resources
Finished December 09, 2020 19:00:14 PM UTC
*****
*****
Step 2: Delete Data Guard status (Primary site)
Description: DG Status service creation - UpdateDgconfig
Job ID: 2873f1f2-9355-4cd2-8245-893957ba5d48
Started December 09, 2020 19:00:14 PM UTC
Update Data Guard status
Finished December 09, 2020 19:00:14 PM UTC
*****
*****

```

```
Step 3: Delete Data Guard status (Standby site)
Description: DG Status service creation - UpdateDgconfig
Job ID: c4bdf567-6525-49f1-b59c-75866e3ce207
Started December 09, 2020 19:00:15 PM UTC
Update Data Guard status
Finished December 09, 2020 19:00:16 PM UTC
*****
*****

Step 4: Delete Standby database (Standby site)
Description: Database service deletion with db name: test_db with
id : d8006215-bbd3-41d0-a37e-a4181adef042
Job ID: e207cac9-4f96-46fa-b120-462ae877bdc1
Started December 09, 2020 19:00:19 PM UTC
Validate db d8006215-bbd3-41d0-a37e-a4181adef042 for deletion
Database Deletion By RHP
Unregister Db From Cluster
Kill Pmon Process
Database Files Deletion
Delete File Groups of Database test_db
Finished December 09, 2020 19:01:07 PM UTC
*****
*****

Data Guard configuration is removed
```

For more information about these command options, see the *Oracle Database Appliance Command Line Reference* chapter in this guide.

Related Topics

- [Oracle Data Guard odacli Commands](#)
Use ODACLI commands to configure and manage Oracle Data Guard in your Oracle Database Appliance deployment.

Patching Oracle Data Guard Databases on Oracle Database Appliance

Understand how you can patch primary and standby databases on Oracle Data Guard using ODACLI commands.

Patching Oracle Data Guard primary and standby databases using ODACLI commands

Before patching the database homes, upload the RDBMS Clone Files for the database version, to the repository. See *Updating Oracle Database Appliance Repository with Database Clone Files Using the CLI* for the procedure to update the repository with the latest RDBMS Clone Files. Also ensure that the primary Oracle Database Appliance system and the standby Oracle Database Appliance system are on the same Oracle Database Appliance release. It is recommended that the two systems be on the latest Oracle Database Appliance release. See *Patching Oracle Database Appliance Bare Metal Systems Using the Command-Line* for the procedure to patch your Oracle Database Appliance deployment.

Follow these steps to patch the databases in your Oracle Data Guard configuration on Oracle Database Appliance:

1. Run the following command on the standby database:

```
# odacli update-dbhome
```

2. After patching job on the standby database is successful, run the following command on the primary database:

```
# odacli update-dbhome
```

3. Confirm that the patching jobs are successful:

```
# /opt/oracle/dcs/bin/odacli list-jobs
```

4. Confirm the existing Data Guard configuration is working properly by running the following command on both primary and standby systems:

```
odacli describe-dataguardstatus -i dgid
```

For more information about these command options, see the *Oracle Database Appliance Command Line Reference* chapter in this guide.

Upgrading Oracle Data Guard Databases on Oracle Database Appliance

Understand how you can upgrade primary and standby databases on Oracle Data Guard using ODACLI commands.

Upgrading Oracle Data Guard primary and standby databases using ODACLI commands

Before upgrading the database homes, upload the RDBMS Clone Files for the database version, to the repository. See *Updating Oracle Database Appliance Repository with Database Clone Files Using the CLI* for the procedure to update the repository with the latest RDBMS Clone Files. Ensure that the primary Oracle Database Appliance system and the standby Oracle Database Appliance system are on the same Oracle Database Appliance release, and on Oracle Database Appliance release 19.8 or later. It is recommended that the two systems be on the latest Oracle Database Appliance release. See *Patching Oracle Database Appliance Bare Metal Systems Using the Command-Line* for the procedure to patch your Oracle Database Appliance deployment.

Follow these steps to upgrade the databases in your Oracle Data Guard configuration on Oracle Database Appliance:

1. Run the following command to disable log transport and apply:

```
EDIT DATABASE primary_database SET STATE='TRANSPORT-OFF';
EDIT DATABASE standby_database SET STATE='APPLY-OFF';
```

2. Upgrade the standby database:

```
# odacli upgrade-database -i standby_databaseId -to
destination_DbHomeId
```

3. Upgrade the primary database:

```
# odacli upgrade-database -i primary_databaseId -to  
destination_DbHomeId
```

4. Run the following command to enable log transport and apply:

```
EDIT DATABASE primary_database SET STATE='TRANSPORT-ON';  
EDIT DATABASE standby_database SET STATE='APPLY-ON';
```

5. Confirm the existing Data Guard configuration is working properly by running the following command on both primary and standby systems several times:

```
odacli describe-dataguardstatus -i dgid
```

For more information about these command options, see the *Oracle Database Appliance Command Line Reference* chapter in this guide.

Related Topics

- [Oracle Data Guard odacli Commands](#)
Use ODACLI commands to configure and manage Oracle Data Guard in your Oracle Database Appliance deployment.

Enabling Oracle Active Data Guard on Existing Configurations

Understand how you can enable Oracle Active Data Guard on existing configurations.

Oracle Active Data Guard is licensed option to the Oracle Database Enterprise Edition and enables advanced capabilities that extend the basic Oracle Data Guard functionality.

Oracle Active Data Guard function requires database to be open as read-only while enabling the *redo log apply* option. Follow these steps to enable Oracle Active Data Guard on existing configurations:

1. Modify database to have read-only start option:

```
srvctl modify database -d standby_db_unique_name -startoption "read  
only"  
srvctl stop database -d standby_db_unique_name  
srvctl start database -d standby_db_unique_name
```

To check if Oracle Data Guard has read-only start option set, run the following command:

```
srvctl config database -d standby_db_unique_name | grep "Start  
options"
```

2. Enable redo log apply by running the following PL/SQL commands:

```
ALTER DATABASE RECOVER MANAGED STANDBY DATABASE CANCEL;
ALTER DATABASE RECOVER MANAGED STANDBY DATABASE DISCONNECT FROM
SESSION;
```

Deconfiguring Oracle Data Guard on Oracle Database Appliance

Deconfigure Oracle Data Guard status using ODACLI commands.

Deconfiguring Oracle Data Guard Status using ODACLI commands

Follow these steps:

- To deconfigure Oracle Data Guard and delete the standby database, run the following command on the primary system:

```
# odacli deconfigure-dataguard -i 8396aac4-f7e7-42e4-
a2e8-0cbbc89ce31b
Standby site address: test_domain
root@test_domain's password:
BUI username for Standby site (default: oda-admin):
BUI password for Standby site:
Standby database will be deleted after Data Guard configuration is
removed. Are you sure you want to proceed? (Y/N): y
Deconfigure Dataguard Started
*****
*****
Step 1: Deconfigure Data Guard (Primary site)
Description: Deconfigure DG service
Job ID: d181fa4b-5bc9-431f-8f83-75ff44c934ff
Started December 09, 2020 18:59:17 PM UTC
Deconfigure Data Guard service
Cleanup broker resources
Finished December 09, 2020 19:00:14 PM UTC
*****
*****
Step 2: Delete Data Guard status (Primary site)
Description: DG Status service creation - UpdateDgconfig
Job ID: 2873f1f2-9355-4cd2-8245-893957ba5d48
Started December 09, 2020 19:00:14 PM UTC
Update Data Guard status
Finished December 09, 2020 19:00:14 PM UTC
*****
*****
Step 3: Delete Data Guard status (Standby site)
Description: DG Status service creation - UpdateDgconfig
Job ID: c4bdf567-6525-49f1-b59c-75866e3ce207
Started December 09, 2020 19:00:15 PM UTC
Update Data Guard status
Finished December 09, 2020 19:00:16 PM UTC
*****
*****
```

```
*****  
Step 4: Delete Standby database (Standby site)  
Description: Database service deletion with db name: test_db with  
id : d8006215-bbd3-41d0-a37e-a4181adef042  
Job ID: e207cac9-4f96-46fa-b120-462ae877bdc1  
Started December 09, 2020 19:00:19 PM UTC  
Validate db d8006215-bbd3-41d0-a37e-a4181adef042 for deletion  
Database Deletion By RHP  
Unregister Db From Cluster  
Kill Pmon Process  
Database Files Deletion  
Delete File Groups of Database test_db  
Finished December 09, 2020 19:01:07 PM UTC  
*****  
*****  
Data Guard configuration is removed
```

For deconfiguring Oracle Data Guard, you must specify the Oracle Data Guard Configuration ID. Run the `odacli list-dataguardstatus` command to find the Oracle Data Guard Configuration ID.

For more information about these command options, see the *Oracle Database Appliance Command Line Reference* chapter in this guide.

Related Topics

- [Oracle Data Guard odacli Commands](#)
Use ODACLI commands to configure and manage Oracle Data Guard in your Oracle Database Appliance deployment.

12

Managing CPU Pools on Oracle Database Appliance Bare Metal and KVM Deployments

Use CPU pools to manage CPU resources on Oracle Database Appliance bare metal and KVM deployments.

- [About CPU Pools](#)
CPU pools enable management of CPU resources on Oracle Database Appliance on both bare metal and KVM deployments. There are two types of CPU pools, that is, BM and VM.
- [Creating a CPU Pool in a Bare Metal or KVM Deployment](#)
Use ODACLI commands or the Browser User Interface to create a CPU pool in a bare metal or KVM deployment.
- [Viewing CPU Pools in a Bare Metal or KVM Deployment](#)
Use ODACLI commands or the Browser User Interface to view all CPU pools or details about a CPU pool in a bare metal or KVM deployment.
- [Modifying a CPU Pool in a Bare Metal or KVM Deployment](#)
Use ODACLI commands or the Browser User Interface to modify a CPU pool in a bare metal or KVM deployment.
- [Deleting a CPU Pool in a Bare Metal or KVM Deployment](#)
Use ODACLI commands or the Browser User Interface to delete a CPU pool in a bare metal or KVM deployment.
- [Viewing CPU Pool Audit Records in a Bare Metal or KVM Deployment](#)
Use ODACLI commands or the Browser User Interface to delete a CPU pool in a bare metal or KVM deployment.
- [About Over-Subscribed CPU Pools](#)
Configure virtual machines so that they do not subscribe to more CPU resources than the resources available in CPU pools.

About CPU Pools

CPU pools enable management of CPU resources on Oracle Database Appliance on both bare metal and KVM deployments. There are two types of CPU pools, that is, BM and VM.

Use the BM CPU pool to ensure that the database on a bare metal host runs exclusively on the CPU lists specified in the CPU pool. All Oracle processes are bound to the CPUs in this CPU pool and run only on these CPUs. The bare metal CPU pool is assigned to database by updating the `init.ora` parameter `processor_group_name`.

Use the VM CPU pools to cage and manage CPU resource allocations to workloads for virtual machines. Workloads are isolated by creating CPU pools and assigning or

pinning virtual machines to a specific CPU pool. When you pin a virtual machine to a CPU pool, you ensure that the virtual machine uses CPUs in only that CPU pool.

Resources in CPU pools cannot overlap, that is, CPU pools cannot share CPUs. But one CPU pool can be assigned to multiple databases (BM CPU pool) or VMs (VM CPU pools).

Oracle Database Appliance provides ODACLI commands to create, update, modify, and delete CPU pools.

About Bare Metal CPU Pools

For new databases, you can attach the new CPU pool using the `create-database` command. For existing databases, use the `modify-database` command to attach the CPU pool to the database. Restart the database manually for changes to take effect. Clone, `irestore` and `recover` database operations will also try to use the same CPU pool if the CPU pool is used by the source database. Specify the `--cpupool` option to use the new `cpupool`. The standby database uses the CPU pool configured for the primary database. Specify the `--cpupool` option in the `irestore-database` command when restoring the backup to the standby site if you want to use a separate CPU pool on the standby site. For more details about the command syntax, see the *Oracle Database Appliance Command Line Interface* chapter in this guide.

About VM CPU Pools

For new VMs, you can attach the new CPU pool using the `create-vm` command. For existing VMs, use the `modify-vm` command to attach or update the CPU pool. Use the `--live` option to apply the changes to a running VM, and use the `--config` parameter to persist the change. For more details about the command syntax, see the *Oracle Database Appliance Command Line Interface* chapter in this guide.

About Audit Records for CPU Pools

CPU pool operations history are recorded in audit records metadata and system log for audit purposes. The CPU pool changes include create, modify, delete operations, and attach and detach operations from VMs and databases. The CPU pool audit records can be queried using `odacli list-auditrecords` and `odacli describe-auditrecord` commands but they can not be changed or deleted. For more details about the command syntax, see the *Oracle Database Appliance Command Line Interface* chapter in this guide.

Understanding the Effect of Changing the CPU Cores on CPU Pool Allocation

You may have changed the CPU core count on Oracle Database Appliance using the `odacli update-cpucore` command. You must assign cores in multiples of two, with a minimum of two cores. If you change the CPU core count, then you can subsequently only increase the CPU core count.

If you change the CPU core count in an Oracle Database Appliance environment which has CPU pools, then the following behavior is seen:

- `odacli create-cpupool` and `odacli modify-cpupool` will always select the online CPUs. Therefore, on both bare metal and KVM deployments, any CPU pool created after running the `odacli update-cpucore` command, will select from the available online CPUs.
- For existing CPU pools on bare metal and KVM deployments, some CPUs can become offline when you run the `odacli update-cpucore` command. Check the

CPU pools for any offline CPUs using the `odacli describe-cpupool` command. You can then update the CPU pool to use available ONLINE CPUs by using the `odacli modify-cpupool` command.

- If the databases use a CPU pool and some CPUs become offline, then use the `odacli modify-cpupool` command to update the CPU pool. Restart the databases to use the updated CPU pool.

Creating a CPU Pool in a Bare Metal or KVM Deployment

Use ODA CLI commands or the Browser User Interface to create a CPU pool in a bare metal or KVM deployment.

Using ODA CLI to Create a CPU Pool

Use the command `odacli create-cpupool` to create a CPU pool.

Create a VM CPU pool named `cpupool1` with 6 cores associated to it.

```
# odacli create-cpupool -n cpupool1 -c 6 -vm
```

Using Browser User Interface to Create a CPU Pool

Follow these steps:

1. Log into the Browser User Interface:

```
https://host-ip-address:7093/mgmt/index.html
```

2. Click the **Appliance** tab.
3. Click **CPU Pool** to display the CPU Pool page.
4. Click **Create CPU Pool**.
5. In the Create CPU Pool page, specify the following:
 - CPU Pool Name: Name of the CPU pool
 - CPU Pool Type: Specify if the CPU pool is bare metal or virtual
 - Number of CPU Cores: Number of CPU cores allocated to the pool
 - Configure on: For high-availability deployments, select the nodes where you want to configure the CPU pool.
6. Click **Create**.
7. When you submit the job, the job ID and a link to the job appears. Click the link to display the job status and details.
8. Validate that the job completed. You can track the job in the **Activity** tab in the Browser User Interface, or run the command `odacli describe-job` with the job ID.

Viewing CPU Pools in a Bare Metal or KVM Deployment

Use ODACLI commands or the Browser User Interface to view all CPU pools or details about a CPU pool in a bare metal or KVM deployment.

Using ODACLI to View CPU Pools

The command `odacli describe-cpupool` displays details about a CPU pool. Use the command `odacli list-cpupools` to view all CPU pools in the deployment.

```
# odacli list-cpupools

# odacli describe-cpupool -n cpupool1
```

Using Browser User Interface to View CPU Pools

Follow these steps:

1. Log into the Browser User Interface:

```
https://host-ip-address:7093/mgmt/index.html
```

2. Click the **Appliance** tab.
3. Click **CPU Pool** to display the CPU Pool page.
4. You can view the list of all configured CPU pools.
5. To view the details of a CPU pool, click on the CPU pool or click on the Actions drop down and select View Details.

Modifying a CPU Pool in a Bare Metal or KVM Deployment

Use ODACLI commands or the Browser User Interface to modify a CPU pool in a bare metal or KVM deployment.

Using ODACLI to Modify CPU Pool

Use the command `odacli modify-cpupool` to modify a CPU pool.

```
# odacli modify-cpupool -n cpupool1 -c 10
```

Restart the associated databases to use the updated CPU pool.

Using Browser User Interface to Modify CPU Pool

Follow these steps:

1. Log into the Browser User Interface:

```
https://host-ip-address:7093/mgmt/index.html
```

2. Click the **Appliance** tab.

3. Click **CPU Pool** to display the CPU Pools page.
4. From the Actions drop down list for the CPU pool you want to modify, select **Modify**.
5. In the Modify CPU Pool page, specify any changes in the Number of CPU Cores, and select if you want to apply the changes to running VMs or if you want to force the modify operation. Then click **Modify**.
6. When you submit the job, the job ID and a link to the job appears. Click the link to display the job status and details.
7. Validate that the job completed. You can track the job in the **Activity** tab in the Browser User Interface, or run the command `odacli describe-job` with the job ID.

Deleting a CPU Pool in a Bare Metal or KVM Deployment

Use ODACLI commands or the Browser User Interface to delete a CPU pool in a bare metal or KVM deployment.

Using ODACLI to Delete CPU Pool

Use the command `odacli delete-cpupool` to delete a CPU Pool.

Delete a CPU pool named `cpupool1`.

```
# odacli delete-cpupool -n cpupool1
```

Using Browser User Interface to Delete CPU Pool

Follow these steps:

1. Log into the Browser User Interface:

```
https://host-ip-address:7093/mgmt/index.html
```

2. Click the **Appliance** tab.
3. Click **CPU Pool** to display the CPU Pool page.
4. From the Actions drop down list for the CPU pool you want to delete, select **Delete**.
5. Click Yes to confirm your choice.
6. When you submit the job, the job ID and a link to the job appears. Click the link to display the job status and details.
7. Validate that the job completed. You can track the job in the **Activity** tab in the Browser User Interface, or run the command `odacli describe-job` with the job ID.

Viewing CPU Pool Audit Records in a Bare Metal or KVM Deployment

Use ODACLI commands or the Browser User Interface to delete a CPU pool in a bare metal or KVM deployment.

Using ODACLI to View Audit Record Details for CPU Pools

Use the `odacli list-auditrecords` command to list the audit records for a CPU Pool:

```
# odacli list-auditrecords
```

Use the `odacli describe-auditrecord` command to describe the audit record for a CPU Pool.

```
# odacli describe-auditrecord
```

Using Browser User Interface to View Audit Record Details for CPU Pools

Follow these steps:

1. Log into the Browser User Interface:

```
https://host-ip-address:7093/mgmt/index.html
```

2. Click the **Security** tab.
3. Select **Show Advanced Search** and specify the filters for the CPU audit records details such as the From and To dates, Resource type, Resource name, DCS user name, Operation type, and the number of records to display the CPU Pool details.
4. From the list of audit records displayed, click on the audit record ID for which you to drill down for more details.

About Over-Subscribed CPU Pools

Configure virtual machines so that they do not subscribe to more CPU resources than the resources available in CPU pools.

A CPU resource can belong to one, and only one, CPU pool. You can assign multiple virtual machines to a CPU pool. A CPU pool becomes oversubscribed when the virtual machines that are active in the pool require more CPUs than you configured for the pool. For example, if a CPU pool has four CPUs, then you can start two virtual machines that are defined to use four CPUs each. In this case, the CPU pool is oversubscribed, because each of the four CPUs is supporting two virtual machines.

If you stop one of those virtual machines, but start another one that requires two CPUs, then the CPU pool is still oversubscribed. This is because two of the CPUs are supporting both virtual machines. When oversubscribing a CPU pool, assess the performance of the virtual machines in that pool. Reassign one or more virtual machines to a different CPU pool if sharing an oversubscribed pool degrades performance to unacceptable levels.

13

Managing an Oracle Database Appliance KVM Deployment

KVM virtualization uses a kernel-based virtual machine (KVM) to create a virtualized environment for your Linux applications.

Understand the Oracle Database Appliance KVM architecture, and procedures to deploy a guest virtual machine, manage high availability, manage CPU pools, and configure network settings for Oracle Database Appliance KVM deployment.

- [About Oracle Database Appliance KVM Deployment](#)
You can use Oracle KVM to optimize your system resource use for databases and applications.
- [About Oracle Database Appliance KVM Virtualization Architecture](#)
Review this topic to understand how Oracle Database Appliance KVM deployment works with Oracle Database Appliance hardware.
- [About Virtual Machines and Oracle Database Appliance KVM Deployments](#)
Oracle Database Appliance KVM deployment is designed to run and deploy virtual machines to manage system resources.
- [About KVM Database Systems on Oracle Database Appliance](#)
Starting with Oracle Database Appliance release 19.10, you can deploy KVM-based database systems on Oracle Database Appliance to run your Oracle Database environments.
- [Managing Database Systems in KVM Deployment](#)
Use ODACLI to create, list, describe, start, stop, and delete database systems in an Oracle Database Appliance KVM deployment.
- [Setting Up and Configuring a KVM Deployment for Applications](#)
Understand the steps to set up and configure KVM deployment for applications.
- [Managing VM Storage in KVM Deployment](#)
Use ODACLI to create, view, modify, and delete VM storage in an Oracle Database Appliance KVM deployment.
- [Managing Virtual Networks in KVM Deployment](#)
Use ODACLI to create, view, start, stop, and delete virtual networks in an Oracle Database Appliance KVM deployment.
- [Managing Virtual Disks in KVM Deployment](#)
Use ODACLI to create, view, clone, modify, and delete virtual disks on Oracle Database Appliance KVM deployment.
- [Managing Virtual Machines in KVM Deployment](#)
Use ODACLI to create, view, clone, modify, start, stop, and delete virtual machines in an Oracle Database Appliance KVM deployment.
- [Example JSON File to Create a Single-Node DB System](#)
Follow the JSON file example to create a JSON file to deploy a single-node DB System, with role separation, with the command `odacli create-dbsystem`.

- [Example JSON File to Create a High-Availability DB System](#)
Follow the JSON file example to create a JSON file to deploy a two-node DB System, with role separation, with the command `odacli create-dbsystem`.

About Oracle Database Appliance KVM Deployment

You can use Oracle KVM to optimize your system resource use for databases and applications.

You can deploy a KVM-based virtual platform on Oracle Database Appliance. With Oracle Database Appliance KVM deployments, you can use the capabilities of Oracle KVM to effectively allocate resources to databases and applications running on the same physical Oracle Database Appliance. Rather than simply disabling unnecessary server cores, you can use the excess capacity to host other workloads. This enables consolidation of both databases and applications, while retaining the ease of deployment and management associated with Oracle Database Appliance.

The Kernel-based Virtual Machine (KVM) feature provides a set of modules that enable you to use the Oracle Linux kernel as a hypervisor. KVM supports both x86_64 and aarch64 processor architectures. By default, KVM is built into the Unbreakable Enterprise Kernel (UEK) release. KVM features are actively developed and may vary depending on platform and kernel release. If you are using Unbreakable Enterprise Kernel, you should refer to the release notes for the kernel release that you are currently using to obtain information about features and any known issues or limitations that may apply. KVM is supported on Oracle Linux 7.

What are the differences between KVM and Oracle VM Virtualization?

Oracle KVM makes it easy to setup and manage the virtualized environment with little virtualization expertise. With the KVM deployment, you can consolidate entire multi-tier environments within a single Oracle Database Appliance system.

The following are some of the advantages of deploying Oracle Database Appliance with the KVM option:

- Deploy database and applications in a single hardware environment.
- Use your CPU cores (and memory) efficiently.
- Use virtual local area networks (VLANs) to provide separate networks to different virtual machines.
- Use VM storage to grow storage for the virtual machine repository.
- Enables easy resource management per VM and maintenance of quality of service (QoS)
- Provides solution-in-a-box with application, middleware, and databases.
- Improves data center efficiency by increasing space utilization and reducing energy consumption and cooling costs.
- Oracle KVM virtualization is available on bare metal deployments of Oracle Database Appliance, whereas Oracle VM virtualization on Oracle Database Appliance requires Virtualized Platform setup.
- Oracle Database Appliance supports KVM on all hardware models, whereas Virtualized Platform deployments using Oracle VM are supported on only Oracle Database Appliance High-Availability models.

- Oracle Database Appliance KVM deployments use Type 2 host operating system-based hypervisor, whereas Oracle Database Appliance Virtualized Platform deployments use Type 1 bare metal hypervisor.
- KVM is the virtualization technology used in Oracle Cloud Infrastructure (OCI), whereas Oracle Database Appliance Virtualized Platform is based on Xen technology.

About Oracle Database Appliance KVM Virtualization Architecture

Review this topic to understand how Oracle Database Appliance KVM deployment works with Oracle Database Appliance hardware.

Oracle Database Appliance KVM deployment provides virtualization technology that enables multiple applications to share the same physical server. The Oracle Database Appliance KVM architecture is engineered specifically to leverage the Oracle Database Appliance hardware capabilities. Oracle Database Appliance KVM stack is integrated with Oracle Clusterware. The KVM resources such as VM storages and Virtual Machines are registered as CRS resources and are automatically managed by CRS for high availability.

The Oracle Database Appliance Virtualized Platform architecture uses the virtual machine components shown in the following illustration:

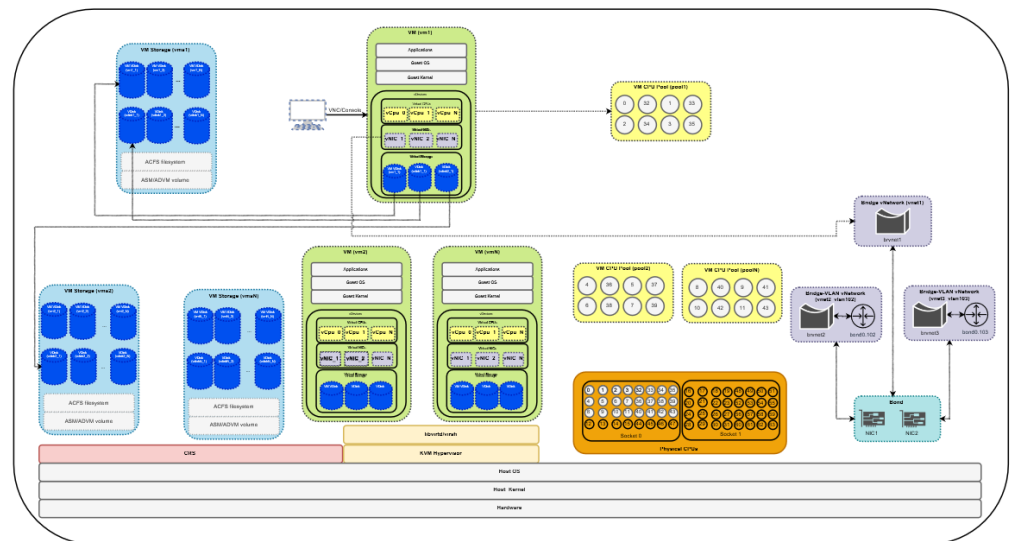

About Virtual Machines and Oracle Database Appliance KVM Deployments

Oracle Database Appliance KVM deployment is designed to run and deploy virtual machines to manage system resources.

Configure virtual machines on Oracle Database Appliance KVM deployment to manage your application use of resources, such as the CPU pool, memory, and other shared resources.

Understand the terminology of the various components you need to set up for an Oracle Database Appliance KVM deployment. The ODA CLI tooling handles all the required configuration for your Oracle Database Appliance KVM deployment.

VM Storage

A *vm storage* is a central location for storing resources that are essential to creating and managing virtual machines. These resources include ISO files (virtual DVD images), virtual machine configuration files, and virtual disks. Virtual storage is configured on an Oracle Automatic Storage Management Cluster File System (Oracle ACFS) and then presented to the Oracle Database Appliance nodes that need access to those resources. Oracle Database Appliance Virtualized Platform uses virtual storage to optimize available disk space usage in the environment, and for easy reallocation of virtual machines if a physical server fails. The virtual machine files can be stored on shared disks, providing shared storage for the virtual machines. You can:

- Create one or more virtual machines on the virtual storage.
- Use ODA CLI commands to create and manage virtual storage, virtual disks, and their virtual machines, and the underlying architecture shown in the illustration.

Virtual Networks

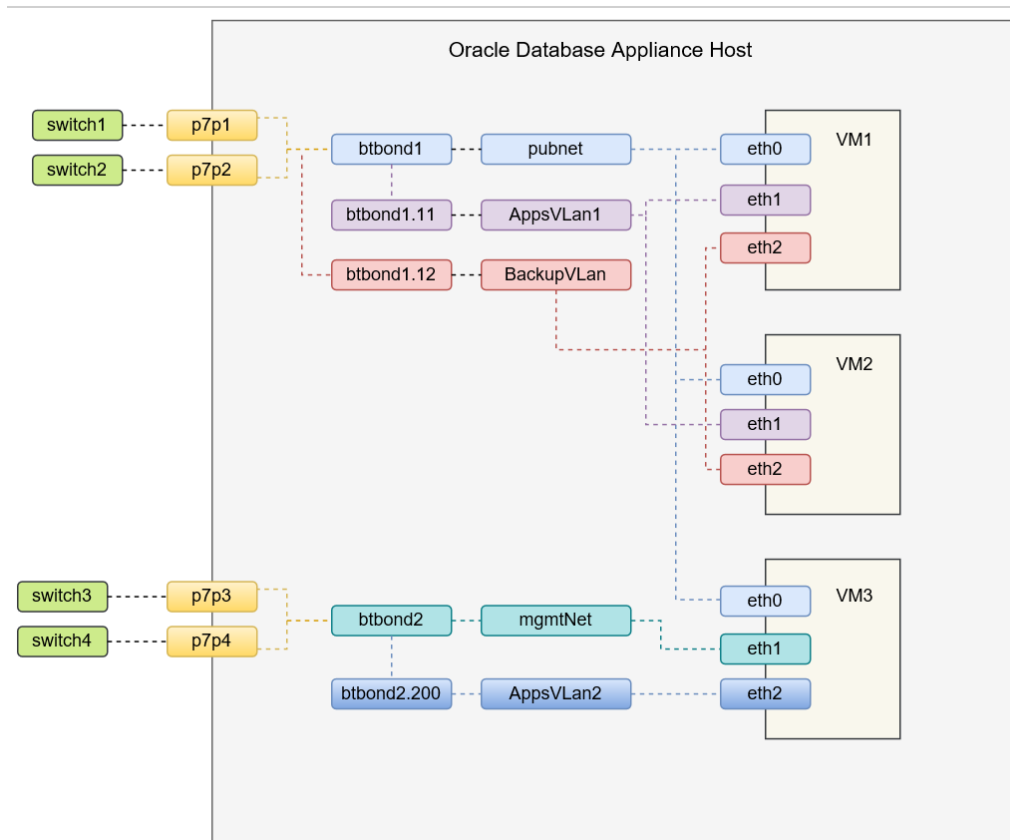

Oracle Database Appliance KVM virtual network supports two type of networks, bridged and bridged-vlan. The above figure is an example of the KVM virtual network on Oracle Database Appliance X8-2 hardware models.

In a bridged network, a Linux bridge is created and the network interface or bond interface, is attached to the bridge. A default bridge network named `pubnet` is created on the public network selected during the appliance deployment. Any VM that wants to access this public network can be attached using this `pubnet` vnetwork. This `pubnet` vnetwork cannot be modified or deleted. In the above diagram, `btbond1` is used for the public network, and default vnetwork `pubnet` is created with `btbond1`. `eth0` of VMs are attached to this `pubnet` vnetwork. Except for the default `pubnet` bridge, no other bridged network is allowed to be created on this public network interface. Additional bridged vnetwork can be created on other interfaces that are not used for the public network. In the above diagram, the `mgmtNet` bridged network is created with `btbond2`. `eth1` of VM3 is attached to this `mgmtNet` vnetwork.

For example:

```
odacli create-vnetwork --name mgmtNet --bridge mgmtNet --type bridged
--interface btbond2 --ip ip_address --gateway gateway --netmask netmask
```

In a bridged-vlan network, VLAN can be created on all available public interfaces, including the interface where public network is already configured. For example, you can create a VLAN on both `btbond1` and `btbond2`. Follow proper procedures to configure the VLAN on the switch before creating the bridged-vlan network. In the figure above, `backupVlan` and `AppsVlan1` are created from `btbond1` and attached to `eth1` and `eth2` of VM1 and VM2 respectively.

For example:

```
odacli create-vnetwork --name backupvlan --bridge backupvlan --type
bridged-vlan --vlan-id 12 --interface btbond1 --ip ip_address --gateway
gateway --netmask netmask
```

vnetwork is not supported on private interfaces and secondary interfaces of the bond interface.

Virtual Disks

In addition to virtual machines, you can create virtual disks in virtual storage. Virtual disks provide additional storage options for virtual machines by enabling you to attach additional block storage to your virtual machines. Similarly, you can detach the disk if you no longer need the additional space. You can use virtual disks to expand existing file system storage inside the virtual machine by extending the storage volume onto a virtual disk, or by creating a new file system on a virtual disk. Virtual disks can optionally be attached to multiple virtual machines.

Virtual Machines

A *virtual machine* is granted virtual resources, and can be started, stopped, cloned, and restarted independently. By default, virtual machines are created with autostart and failover enabled for high-availability models. During failover, the VM is automatically started during the reboot, and there will be attempt to restart once before failing over to a different node on high-availability models. You can enable or disable

autostart and failover using the `odacli modify-vm` command options. The option to autostart is also available on single-node Oracle Database Appliance models.

About KVM Database Systems on Oracle Database Appliance

Starting with Oracle Database Appliance release 19.10, you can deploy KVM-based database systems on Oracle Database Appliance to run your Oracle Database environments.

About KVM Database Systems

KVM database systems enable hard partitioning for Oracle Database licensing, where each KVM database system has its own CPU pool that is automatically assigned during KVM database system creation. Oracle Database Appliance simplifies the management of KVM database systems with the built-in Browser User Interface (BUI) or ODACLI Command Line Interface (ODA CLI).

About KVM Database System Architecture

You can provision and configure a database system on an Oracle KVM. The database can be a single-instance Oracle Database or an Oracle RAC Database with two instances.

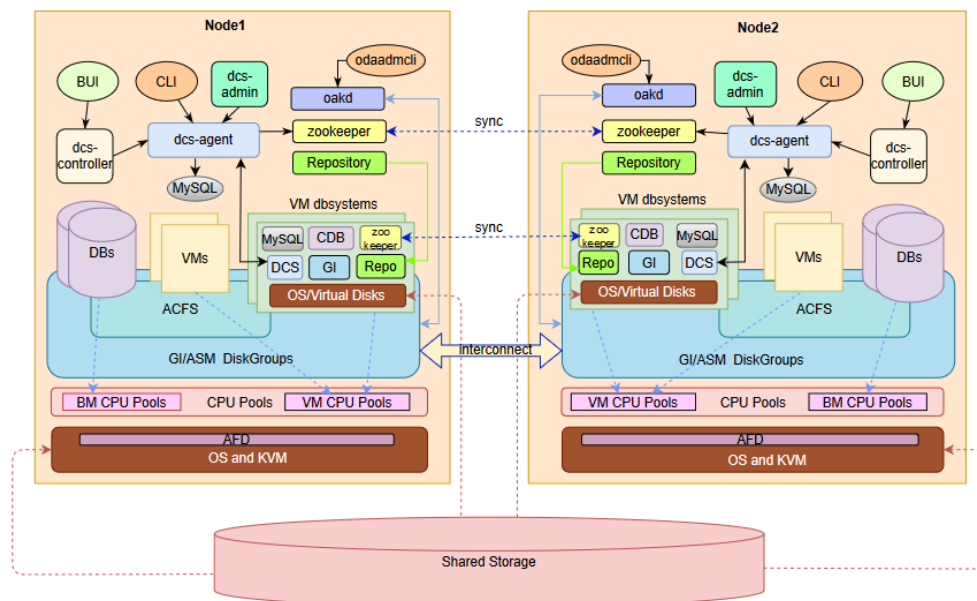

About KVM Database System Networks

Each Oracle Database Appliance database system on KVM has the following networks created by default:

- **Public network:** In Oracle Database Appliance database system on KVM, the default vnetwork `pubnet` is created based on the public interface you select for GI

provisioning. The pubnet network is selected by default as the public network of the database system.

- Oracle ASM network and database system cluster interconnect network are created and managed internally. 192.168.16.0/24 and 192.168.17.0/24 are reserved for the use of these two internal networks. So, ensure that the IP addresses 192.168.16.0/24 and 192.168.17.0/24 are available for use by Oracle Database Appliance database system on KVM.

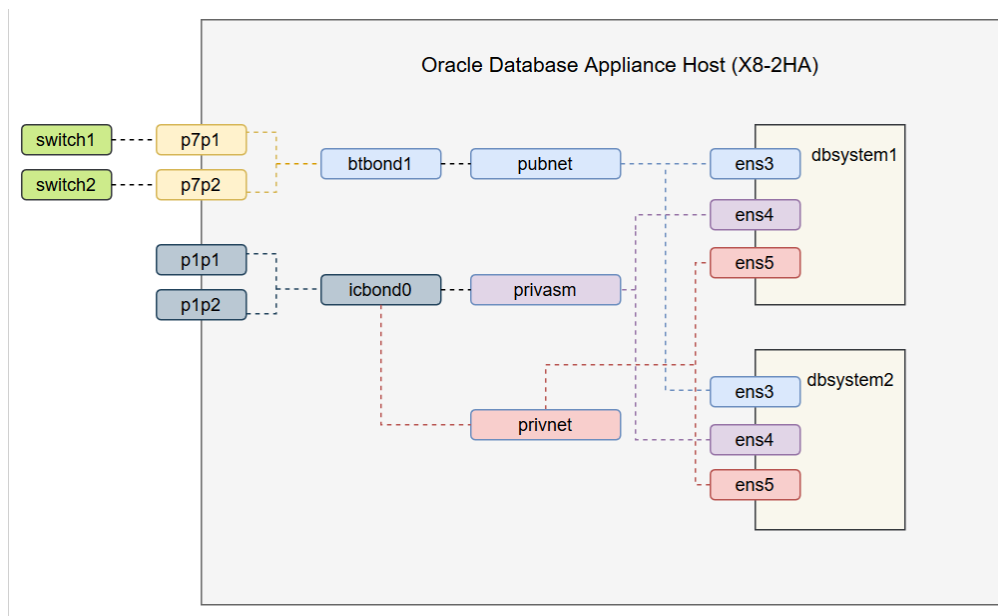

Restrictions When Deploying KVM Database System

The following restrictions apply when you deploy KVM database system on Oracle Database Appliance:

- You can create only one database for each database system.
- The shape of the database system is derived from the shape you select for the database. The CPU cores for the database system is set as defined in the database shape. For example, if you select odb4 as the database shape, in which the database uses 4 cores, then the database system is created with 4 cores. However, for database shapes odb1s and odb1, the database system is created with 2 cores.
- You cannot use Oracle ACFS for storage within the database system. The database system uses Oracle ASM storage.
- Only Oracle Database release 19.10 is supported within the database system.
- You cannot configure CPU Pools or run VM commands within the database system.

Managing Database Systems in KVM Deployment

Use ODACLI to create, list, describe, start, stop, and delete database systems in an Oracle Database Appliance KVM deployment.

! **Important:**

Your bare metal deployment must be on Oracle Database Appliance release 19.10 before you create a KVM database system. If your system is patched to Oracle Database Appliance release 19.10, then download Oracle Grid Infrastructure and Oracle Database clone files separately, before you create the Oracle KVM Database System.

- [Creating a Database System in a KVM Deployment](#)
Use ODACLI commands or the Browser User Interface to create a database system in a KVM deployment.
- [Listing Database Systems in a KVM Deployment](#)
Use ODACLI commands or the Browser User Interface to list database systems in a KVM deployment.
- [Describing a Database System in a KVM Deployment](#)
Use ODACLI commands or the Browser User Interface to describe a database system in a KVM deployment.
- [Starting a Database System in a KVM Deployment](#)
Use ODACLI commands or the Browser User Interface to start a database system in a KVM deployment.
- [Stopping a Database System in a KVM Deployment](#)
Use ODACLI commands or the Browser User Interface to stop a database system in a KVM deployment.
- [Deleting a Database System in a KVM Deployment](#)
Use ODACLI commands or the Browser User Interface to delete a database system in a KVM deployment.

Creating a Database System in a KVM Deployment

Use ODACLI commands or the Browser User Interface to create a database system in a KVM deployment.

! **Important:**

Your bare metal deployment must be on Oracle Database Appliance release 19.10 before you create a KVM database system. If your system is patched to Oracle Database Appliance release 19.10, then download Oracle Grid Infrastructure and Oracle Database clone files separately, before you create the Oracle KVM Database System.

Using ODACLI to Create a KVM Database System

Use the command `odacli create-dbsystem` to create a KVM database system.

Follow these steps:

1. Download the Oracle Database Appliance KVM DB System Image (patch 32451228) from My Oracle Support to a temporary location on an external client. Refer to the release notes for details about the software for the latest release.

```
p32451228_1910000_Linux-x86-64.zip
```

2. Unzip the software — it contains README.html and one or more zip files for the patch.

```
unzip p32451228_1910000_Linux-x86-64.zip
odacli-dcs-19.10.0.0.0-210217.2-ODAVM-19.10.0.0.zip
```

3. Update the repository with the image. The database system version must be the same as the Oracle Database Appliance version.

```
# /opt/oracle/dcs/bin/odacli update-repository -f /tmp/odacli-
dcs-19.10.0.0.0-210217.2-ODAVM-19.10.0.0.zip
```

4. Run the `odacli describe-dbsystem-image` command to query the supported Oracle Grid Infrastructure and Oracle Database versions for this database system KVM image.

```
# odacli describe-dbsystem-image
DB System Image details
-----
Component Name Supported Versions Available Versions
-----
DBVM            19.10.0.0.0      not-available
GI              19.10.0.0.210119 19.10.0.0.210119
DB              19.10.0.0.210119 19.10.0.0.210119
```

5. If the `odacli describe-dbsystem-image` command output shows any component as `not-available` on the system, then download the component with supported versions and run the `odacli update-repository` to import the component to the repository.
6. Create the `prov.json` file as per examples provided in this chapter.
7. Run the `odacli create-dbsystem` command with the `prov.json` file on the host.

```
# odacli create-dbsystem -p prov.json
```

Using Browser User Interface to Create a KVM Database System

Follow these steps:

1. Log into the Browser User Interface:

```
https://host-ip-address:7093/mgmt/index.html
```

2. Click the **Appliance** tab.
3. Click **DB Systems** to display the DB Systems page.

4. In the page, if no DB System exists, then click **Create DB System**.
5. In the Create DB System page, provide the DB system values.
6. If you want to use an existing configuration file, click **Browse** and select the configuration file. The system information from the file is populated in the relevant fields.
7. In the System Information section, specify the values as follows.
 - **DB System Name:** Enter the DB System name. The name cannot end with a dash (-). Do not exceed 15 characters.
 - **Domain Name:** Enter the domain name.
 - **Region:** Select the region of the world where the Oracle Database Appliance is located.
 - **Time Zone:** Select the time zone where the Oracle Database Appliance is located.
 - **Disk Group for VM Storage:** Select the disk group that is used for hosting the KVM storage. Note that this is different from the database file storage for the database that runs in the KVM.
 - **System Password and Confirm Password:** Enter the system password in both fields. The system password is the password set for UNIX and `root` users. The password must contain at least two characters each from: uppercase letters, lowercase letters, numbers (0-9), and allowed special characters #, - or _. The password must have a minimum of 9 characters and a maximum of 30 characters.
 - (Optional) **DNS Servers:** Enter addresses for one or more DNS servers.
 - (Optional) **NTP Servers:** Enter addresses for one or more NTP servers.
8. In the Network Information section, specify the client access network details, depending on whether it is a single-node or two-node Oracle Database Appliance deployment:
 - **Node Name:** For Node0, enter the host name for the primary client access network.
 - **IP Address:** Enter the virtual IP address and is shared between the nodes.
 - **Subnet Mask:** Enter the subnet mask address for the primary client access network.
 - **Gateway:** Enter the gateway address for the primary client access network.

For two-node deployments, provide the above values for both nodes. In addition, you must also specify the following:

 - **VIP:** Specify the Virtual IP address.
 - **SCAN:** Specify the Single Client Access Name (SCAN).
9. Determine how you want to configure your users and groups and whether or not you want to allow operating system role separation:
 - Two users with six groups: Customize Users and Groups, select **No**. Allow OS Role Separation, select **Yes**. This is the default configuration.
 - Two customized users with six customized groups: Customize Users and Groups, select **Yes**. Allow OS Role Separation, select **Yes**.

- Single user with two groups: Customize Users and Groups, select **No**. Allow OS Role Separation, select **No**.
 - Single user with six groups: Customize Users and Groups, select **Yes**. Allow OS Role Separation, select **No**.
 - Specify the **GI User**, **DB User**, **Install Group**, **DBA Oper Group**, **DBA Group**, **ASM Admin Group**, **ASM Oper Group**, **ASM DBA Group**, and the User and Group IDs.
10. Enter the following information to configure the database:
- **DB Name**: Enter a name for the database. The name must contain alphanumeric characters and cannot exceed 8 characters.
 - (Optional) **DB Unique Name**: Enter a globally unique name for the database. Databases with the same DB Name within the same domain (for example, copies of a database created for reporting or a physical standby) must have a different DB Unique Name that is unique within the enterprise. The name must begin with a lowercase or uppercase letter, and contain only alphanumeric characters and underscores(_). The name must not contain dollar (\$), and pound (#) characters. The name cannot exceed 30 characters.
 - **CDB**: Select **Yes** or **No** to specify whether or not you want a Container Database (CDB).
 - **PDB Name**: Enter a name for the pluggable database (PDB).
 - **PDB Admin User**: Enter an Admin user name for the pluggable database (PDB). The name must begin with an alphanumeric character. You can specify alphanumeric characters and underscore (_) in the name.
 - **Database Edition**: Select the Oracle Database edition, either Standard Edition and Enterprise Edition. Your license determines which database edition you are eligible to create in the DB System.
 - **Password** and **Confirm Password**: Provide a password for the database.
 - **Shape**: Select a database shape from the list.
 - In the **Database Class** field, select a database class from the drop-down list. If an option is not available in the list, it is not supported for the database edition on the Oracle Database Appliance or the version that you selected. The default is OLTP.
 - **Configure EM Express**: Select **Yes** or **No**. Select **Yes** to configure the Oracle Enterprise Manager Database Express (EM Express) console for Oracle Database 12.2.1.0 or 12.1.0.2.
 - **Character set**: Select a character set.
 - **National Characterset**: Select a national characterset.
 - **Language**: Select the database language.
 - **Territory**: Select a territory or location from the list.
 - For Oracle Database Enterprise Edition 18c or later, you can choose to enable Transparent Database Encryption (TDE). Select **Yes** or **No** in the **Enable TDE** option. Specify and confirm the **TDE Password**. By default, the TDE option is disabled.
11. Click **Create**.

12. When you submit the job, the job ID and a link to the job appears. Click the link to display the job status and details.
13. Validate that the job completed. You can track the job in the **Activity** tab in the Browser User Interface, or run the command `odacli describe-job` with the job ID.

Related Topics

- [Example JSON File to Create a High-Availability DB System](#)
Follow the JSON file example to create a JSON file to deploy a two-node DB System, with role separation, with the command `odacli create-dbsystem`.
- [Example JSON File to Create a Single-Node DB System](#)
Follow the JSON file example to create a JSON file to deploy a single-node DB System, with role separation, with the command `odacli create-dbsystem`.
- [odacli describe-dbsystem-image](#)
Use the `odacli describe-dbsystem-image` command to view the supported Oracle Grid Infrastructure and Oracle Database versions and the availability of the clone files and Database System KVM image in the Oracle Database Appliance system.

Listing Database Systems in a KVM Deployment

Use ODACLI commands or the Browser User Interface to list database systems in a KVM deployment.

Using ODACLI to List KVM Database Systems

Use the command `odacli list-dbsystems` to list KVM database systems.

```
# odacli list-dbsystems
```

Using Browser User Interface to List KVM Database Systems

Follow these steps:

1. Log into the Browser User Interface:

```
https://host-ip-address:7093/mgmt/index.html
```

2. Click the **Appliance** tab.
3. Click **DB Systems** to display the DB Systems page.
4. In the page, click on the DB System for which you want to view details.

Related Topics

- [odacli list-dbsystems](#)
Use the `odacli list-dbsystems` command to view the database systems on Oracle Database Appliance Kernel-based Virtual Machine (KVM).

Describing a Database System in a KVM Deployment

Use ODACLI commands or the Browser User Interface to describe a database system in a KVM deployment.

Using ODACLI to Describe a KVM Database System

Use the command `odacli describe-dbsystem` to describe a KVM database system.

```
# odacli describe-dbsystem -n dbsystem_name
```

Using Browser User Interface to Describe a KVM Database System

Follow these steps:

1. Log into the Browser User Interface:

```
https://host-ip-address:7093/mgmt/index.html
```

2. Click the **Appliance** tab.
3. Click **DB Systems** to display the DB Systems page.
4. In the page, click on the DB System for which you want to view details or click on the **Actions** drop down and select **View Details** to view the DB System details.
5. Click on the System Information tab for the DB System details, associated CPU Pool, Storage details, and associated VMs.
6. Click on the Database Information tab to view the associated database details.
7. Click on the Network Information tab to view the network details for single node or high-availability deployments.

Related Topics

- [odacli describe-dbsystem](#)
Use the `odacli describe-dbsystem` command to describe a database system on Oracle Database Appliance Kernel-based Virtual Machine (KVM).

Starting a Database System in a KVM Deployment

Use ODACLI commands or the Browser User Interface to start a database system in a KVM deployment.

Using ODACLI to start a KVM Database System

Use the command `odacli start-dbsystem` to start a KVM database system.

```
# odacli start-dbsystem -n dbsystem_name
```

Using Browser User Interface to Start a KVM Database System

Follow these steps:

1. Log into the Browser User Interface:

```
https://host-ip-address:7093/mgmt/index.html
```

2. Click the **Appliance** tab.
3. Click **DB Systems** to display the DB Systems page.
4. In the page, click on the DB System which you want to start.
5. Click on the System Information tab and then click **Start**.
6. For high-availability deployments, select the node on which you want to start the DB System. Click **Yes**.
7. When you submit the job, the job ID and a link to the job appears. Click the link to display the job status and details.
8. Validate that the job completed. You can track the job in the **Activity** tab in the Browser User Interface, or run the command `odacli describe-job` with the job ID.
9. When the DB System starts, the state displays as ONLINE.

Related Topics

- [odacli start-dbsystem](#)
Use the `odacli start-dbsystem` command to start a database system on Oracle Database Appliance Kernel-based Virtual Machine (KVM).

Stopping a Database System in a KVM Deployment

Use ODACLI commands or the Browser User Interface to stop a database system in a KVM deployment.

Using ODACLI to Stop a KVM Database System

Use the command `odacli stop-dbsystem` to stop a KVM database system.

```
# odacli stop-dbsystem -n dbsystem_name
```

Using Browser User Interface to Stop a KVM Database System

Follow these steps:

1. Log into the Browser User Interface:

```
https://host-ip-address:7093/mgmt/index.html
```

2. Click the **Appliance** tab.
3. Click **DB Systems** to display the DB Systems page.
4. In the page, click on the DB System which you want to stop.
5. Click on the System Information tab and then click **Stop**.
6. For high-availability deployments, select the node on which you want to stop the DB System. Click **Yes**.

7. When you submit the job, the job ID and a link to the job appears. Click the link to display the job status and details.
8. Validate that the job completed. You can track the job in the **Activity** tab in the Browser User Interface, or run the command `odacli describe-job` with the job ID.
9. When the DB System stops, the state displays as OFFLINE.

Related Topics

- [odacli stop-dbsystem](#)
Use the `odacli stop-dbsystem` command to stop a database system on Oracle Database Appliance Kernel-based Virtual Machine (KVM).

Deleting a Database System in a KVM Deployment

Use ODACLI commands or the Browser User Interface to delete a database system in a KVM deployment.

Important:

Use the DROP DATABASE statement to drop the database, and then deinstall Oracle Database and Oracle Grid Infrastructure components inside the database system before deleting the database system. See *Oracle Database Installation Guide* and *Oracle Grid Infrastructure Installation Guide* in the Oracle Database documentation library for the procedures to deinstall Oracle Database and Oracle Grid Infrastructure.

Using ODACLI to Delete a KVM Database System

Use the command `odacli delete-dbsystem` to delete a KVM database system.

```
# odacli delete-dbsystem -n dbsystem_name
```

Using Browser User Interface to Delete a KVM Database System

Follow these steps:

1. Log into the Browser User Interface:

```
https://host-ip-address:7093/mgmt/index.html
```

2. Click the **Appliance** tab.
3. Click **DB Systems** to display the DB Systems page.
4. In the page, for DB System which you want to delete, click on the **Actions** drop down list and select **Delete**.
5. Confirm that you want to delete the DB System. Select **Force Delete** to force the delete operation. Click **Yes**.
6. When you submit the job, the job ID and a link to the job appears. Click the link to display the job status and details.

7. Validate that the job completed. You can track the job in the **Activity** tab in the Browser User Interface, or run the command `odacli describe-job` with the job ID.

Related Topics

- [odacli delete-dbsystem](#)
Use the `odacli delete-dbsystem` command to delete a database system on Oracle Database Appliance Kernel-based Virtual Machine (KVM).

Setting Up and Configuring a KVM Deployment for Applications

Understand the steps to set up and configure KVM deployment for applications.

Follow these steps to set up a KVM deployment on Oracle Database Appliance

1. Create a VM storage.
2. Create a virtual network.
3. Create virtual disks.
4. Create virtual machines.

The following links provide information about performing these steps:

Related Topics

- [Creating a VM Storage in a KVM Deployment](#)
Use ODACLI commands or the Browser User Interface to create a VM storage in a KVM deployment.
- [Creating a Virtual Network in a KVM Deployment](#)
Use ODACLI commands or the Browser User Interface to create a virtual network in a KVM deployment.
- [Creating a Virtual Disk in a KVM Deployment](#)
Use ODACLI commands or the Browser User Interface to create a virtual disk in a KVM deployment.
- [Creating a Virtual Machine in a KVM Deployment](#)
Use ODACLI commands or the Browser User Interface to create a virtual machine in a KVM deployment.

Managing VM Storage in KVM Deployment

Use ODACLI to create, view, modify, and delete VM storage in an Oracle Database Appliance KVM deployment.

- [Creating a VM Storage in a KVM Deployment](#)
Use ODACLI commands or the Browser User Interface to create a VM storage in a KVM deployment.
- [Viewing VM Storage in a KVM Deployment](#)
Use ODACLI commands or the Browser User Interface to view all VM storage or details about a VM storage in a KVM deployment.

- [Modifying a Virtual Storage in a KVM Deployment](#)
Use ODACLI commands or the Browser User Interface to modify a virtual storage in a KVM deployment.
- [Deleting a VM Storage in a KVM Deployment](#)
Use ODACLI commands or the Browser User Interface to delete a VM storage in a KVM deployment.

Creating a VM Storage in a KVM Deployment

Use ODACLI commands or the Browser User Interface to create a VM storage in a KVM deployment.

Using ODACLI to Create VM Storage

Use the command `odacli create-vmstorage` to create a VM Storage.

Create a VM storage named `share1` of 8 GB.

```
# odacli create-vmstorage -n share1 -s 8G
```

Using Browser User Interface to Create VM Storage

Follow these steps:

1. Log into the Browser User Interface:

```
https://host-ip-address:7093/mgmt/index.html
```

2. Click the **Appliance** tab.
3. Click **Show VM Instances** to display the VM Instances page.
4. In the page, select the **Create VM Storage** option and click **Next**.
5. In the Create VM Storage page, specify the following:
 - Storage Name: Name of the VM storage
 - Storage Size: Size of the storage to be allocated
6. Click **Create**.
7. When you submit the job, the job ID and a link to the job appears. Click the link to display the job status and details.
8. Validate that the job completed. You can track the job in the **Activity** tab in the Browser User Interface, or run the command `odacli describe-job` with the job ID.

Viewing VM Storage in a KVM Deployment

Use ODACLI commands or the Browser User Interface to view all VM storage or details about a VM storage in a KVM deployment.

Using ODACLI to View VM Storage

The command `odacli describe-vmstorage` displays details about VM storage. Use the command `odacli list-vmstorages` to view all VM storages in the deployment.

```
# odacli list-vmstorages
```

```
# odacli describe-vmstorage
```

Using Browser User Interface to View VM Storage

Follow these steps:

1. Log into the Browser User Interface:

```
https://host-ip-address:7093/mgmt/index.html
```

2. Click the **Appliance** tab.
3. Click **VM Instances** to display the VM Details page.
4. Click the **Show VM Storage** tab to view the list of all configured virtual storages.
5. Click on a VM Storage to view the details of the virtual storage.

Modifying a Virtual Storage in a KVM Deployment

Use ODACLI commands or the Browser User Interface to modify a virtual storage in a KVM deployment.

Using ODACLI to Modify Virtual Storages

Use the command `odacli modify-vmstorage` to modify VM storage.

Increase the size of a VM storage named `share1` by 10 gigabytes.

```
# odacli modify-vmstorage -n share1 -i 10G
```

Using Browser User Interface to Modify VM Storage

Follow these steps:

1. Log into the Browser User Interface:

```
https://host-ip-address:7093/mgmt/index.html
```

2. Click the **Appliance** tab.
3. Click **VM Instances** to display the VM Details page.

4. Click the **Show VM Storage** tab.
5. In the page, select a Virtual Storage, select the **Modify** option and click **Next**.
6. In the Modify VM Storage page, specify Increment in size and click **Modify**.
7. When you submit the job, the job ID and a link to the job appears. Click the link to display the job status and details.
8. Validate that the job completed. You can track the job in the **Activity** tab in the Browser User Interface, or run the command `odacli describe-job` with the job ID.

Deleting a VM Storage in a KVM Deployment

Use ODACLI commands or the Browser User Interface to delete a VM storage in a KVM deployment.

Using ODACLI to Delete VM Storage

Use the command `odacli delete-vmstorage` to delete a VM storage.

Delete a VM storage named `vs1`.

```
# odacli delete-vmstorage -n vs1
```

Using Browser User Interface to Modify VM Storage

Follow these steps:

1. Log into the Browser User Interface:

```
https://host-ip-address:7093/mgmt/index.html
```

2. Click the **Appliance** tab.
3. Click **VM Instances** to display the VM Details page.
4. Click the **Show VM Storage** tab.
5. In the page, select a VM Storage, select the **Delete** option.
6. Click Yes to confirm your choice.
7. When you submit the job, the job ID and a link to the job appears. Click the link to display the job status and details.
8. Validate that the job completed. You can track the job in the **Activity** tab in the Browser User Interface, or run the command `odacli describe-job` with the job ID.

Managing Virtual Networks in KVM Deployment

Use ODACLI to create, view, start, stop, and delete virtual networks in an Oracle Database Appliance KVM deployment.

- [Creating a Virtual Network in a KVM Deployment](#)

Use ODACLI commands or the Browser User Interface to create a virtual network in a KVM deployment.

- [Viewing Virtual Networks in a KVM Deployment](#)
Use ODACLI commands or the Browser User Interface to view all virtual networks or details about a virtual network in a KVM deployment.
- [Starting and Stopping Virtual Networks in a KVM Deployment](#)
Use ODACLI commands or the Browser User Interface to start or stop virtual networks in a KVM deployment.
- [Modifying a Virtual Network in a KVM Deployment](#)
Use ODACLI commands or the Browser User Interface to modify a virtual network in a KVM deployment.
- [Deleting a Virtual Network in a KVM Deployment](#)
Use ODACLI commands or the Browser User Interface to delete a virtual network in a KVM deployment.

Creating a Virtual Network in a KVM Deployment

Use ODACLI commands or the Browser User Interface to create a virtual network in a KVM deployment.

Using ODACLI to Create Virtual Network

Use the command `odacli create-vnetwork` to create a virtual network.

Create a VM network of type `bridged` using the interface `btbond2`.

```
# odacli create-vnetwork --name mgmtNet --bridge mgmtNet --type  
bridged --interface btbond2 --ip 192.168.120.26 --gateway 192.168.120.1  
--netmask 255.255.255.0
```

Create a VM network of type `bridged-vlan` using the interface `btbond1`.

```
# odacli create-vnetwork --name backupvlan --bridge backupvlan --type  
bridged-vlan --vlan-id 12 --interface btbond1 --ip 192.168.100.10 --  
gateway 192.168.100.1 --netmask 255.255.255.0
```

Using Browser User Interface to Create Virtual Network

Follow these steps:

1. Log into the Browser User Interface:

```
https://host-ip-address:7093/mgmt/index.html
```

2. Click the **Appliance** tab.
3. Click **Show VM Instances** to display the VM Instances page.
4. In the page, select the **Create Virtual Network** option and click **Next**.
5. In the Create Virtual Network page, specify the following:
 - Name: Name of the virtual network
 - IP Address: Virtual network IP address
 - Subnet Mask and Gateway: Virtual network subnet mask and gateway

- Network Type: Virtual network type
 - Interface: Virtual network interface
 - Bridge Name: Name of the network bridge
 - VLAN ID: ID of the VLAN network
6. Click **Create**.
 7. When you submit the job, the job ID and a link to the job appears. Click the link to display the job status and details.
 8. Validate that the job completed. You can track the job in the **Activity** tab in the Browser User Interface, or run the command `odacli describe-job` with the job ID.

Viewing Virtual Networks in a KVM Deployment

Use ODACLI commands or the Browser User Interface to view all virtual networks or details about a virtual network in a KVM deployment.

Using ODACLI to View Virtual Networks

The command `odacli describe-vnetwork` displays details about a virtual network. Use the command `odacli list-vnetworks` to view all virtual networks in the deployment.

```
# odacli list-vnetworks
```

```
# odacli describe-vnetwork -n vnet1
```

Using Browser User Interface to Create Virtual Networks

Follow these steps:

1. Log into the Browser User Interface:

```
https://host-ip-address:7093/mgmt/index.html
```

2. Click the **Appliance** tab.
3. Click **VM Instances** to display the VM Details page.
4. Click the **Show Virtual Networks** tab to view the list of all configured virtual networks.
5. Click on a Virtual Network to view the details of the virtual network.

Starting and Stopping Virtual Networks in a KVM Deployment

Use ODACLI commands or the Browser User Interface to start or stop virtual networks in a KVM deployment.

Using ODACLI to Start and Stop Virtual Networks

The command `odacli start-vnetwork` starts a virtual network. Use the command `odacli stop-vnetwork` to stop a virtual network in the deployment.

```
# odacli start-vnetwork -n vnet1
```

```
# odacli stop-vnetwork -n vnet1
```

Using Browser User Interface to Start and Stop Virtual Networks

Follow these steps:

1. Log into the Browser User Interface:

```
https://host-ip-address:7093/mgmt/index.html
```

2. Click the **Appliance** tab.
3. Click **VM Instances** to display the VM Details page.
4. Click the **Show Virtual Networks** tab to view the list of all configured virtual networks.
5. To start a virtual network, click on a Virtual Network, and then click **Start**.
6. To stop a virtual network, click on a virtual network, and then click **Stop**.

Modifying a Virtual Network in a KVM Deployment

Use ODACLI commands or the Browser User Interface to modify a virtual network in a KVM deployment.

Using ODACLI to Modify Virtual Network

Use the command `odacli modify-vnetwork` to modify a virtual network.

```
# odacli modify-vnetwork -n vnet1 -g 10.11.44.41
```

Using Browser User Interface to Modify Virtual Network

Follow these steps:

1. Log into the Browser User Interface:

```
https://host-ip-address:7093/mgmt/index.html
```

2. Click the **Appliance** tab.
3. Click **VM Instances** to display the VM Details page.

4. Click the **Show Virtual Networks** tab.
5. In the page, select a Virtual Network, select the **Modify** option and click **Next**.
6. In the Modify Virtual Network page, specify any changes in the Subnet Mask, Gateway, or IP Address, and click **Modify**.
7. When you submit the job, the job ID and a link to the job appears. Click the link to display the job status and details.
8. Validate that the job completed. You can track the job in the **Activity** tab in the Browser User Interface, or run the command `odacli describe-job` with the job ID.

Deleting a Virtual Network in a KVM Deployment

Use ODACLI commands or the Browser User Interface to delete a virtual network in a KVM deployment.

Using ODACLI to Delete Virtual Networks

Use the command `odacli delete-vnetwork` to delete a virtual network.

Delete a virtual network named `vnet1`.

```
# odacli delete-vnetwork -n vnet1
```

Using Browser User Interface to Modify Virtual Networks

Follow these steps:

1. Log into the Browser User Interface:

```
https://host-ip-address:7093/mgmt/index.html
```

2. Click the **Appliance** tab.
3. Click **VM Instances** to display the VM Details page.
4. Click the **Show Virtual Networks** tab.
5. In the page, select a virtual network, select the **Delete** option.
6. Click Yes to confirm your choice.
7. When you submit the job, the job ID and a link to the job appears. Click the link to display the job status and details.
8. Validate that the job completed. You can track the job in the **Activity** tab in the Browser User Interface, or run the command `odacli describe-job` with the job ID.

Managing Virtual Disks in KVM Deployment

Use ODACLI to create, view, clone, modify, and delete virtual disks on Oracle Database Appliance KVM deployment.

- [Creating a Virtual Disk in a KVM Deployment](#)
Use ODACLI commands or the Browser User Interface to create a virtual disk in a KVM deployment.

- [Viewing Virtual Disks in a KVM Deployment](#)
Use ODACLI commands or the Browser User Interface to view all virtual disks or details about a virtual disk in a KVM deployment.
- [Cloning a Virtual Disk in a KVM Deployment](#)
Use ODACLI commands or the Browser User Interface to clone a virtual disk in a KVM deployment.
- [Modifying a Virtual Disk in a KVM Deployment](#)
Use ODACLI commands or the Browser User Interface to modify a virtual disk in a KVM deployment.
- [Deleting a Virtual Disk in a KVM Deployment](#)
Use ODACLI commands or the Browser User Interface to delete a virtual disk in a KVM deployment.

Creating a Virtual Disk in a KVM Deployment

Use ODACLI commands or the Browser User Interface to create a virtual disk in a KVM deployment.

Ensure that a VM storage exists before you create a virtual disk.

Using ODACLI to Create Virtual Disks

Use the command `odacli create-vdisk` to create a virtual disk.

Specify the name of the virtual disk in the command `odacli create-vdisk -n name`. Identify the storage in which you create the virtual disk by using the `-st storage` option. Use the option `-s size` to specify the virtual disk size. If you want to configure the virtual disk as a shared disk, then use the option `-sh`.

Create a 2 GB non-sparse and shareable virtual disk named `vdisk1` inside the VM storage `vms1`.

```
odacli create-vdisk -n vdisk1 -st vms1 -s 2G -sh
```

Using Browser User Interface to Create Virtual Disks

Follow these steps:

1. Log into the Browser User Interface:

```
https://host-ip-address:7093/mgmt/index.html
```

2. Click the **Appliance** tab.
3. Click **VM Instances** to display the Virtual Disk page.
4. Click **Create Virtual Disk**.
5. In the page, select the **Create Virtual Disk** option and click **Next**.
6. In the Create Virtual Disk page, specify the following:
 - Virtual Disk Name: Name assigned to the virtual disk that is unique within the name repository
 - VM Storage Name: Name of the VM storage where the virtual disk will be created

- Disk Size: Size of the virtual disk
 - Shared: Specify if you want to share the virtual disk
 - Sparse or Shared: Specify if the virtual disk is sparse
7. Click **Create**.
 8. When you submit the job, the job ID and a link to the job appears. Click the link to display the job status and details.
 9. Validate that the job completed. You can track the job in the **Activity** tab in the Browser User Interface, or run the command `odacli describe-job` with the job ID.

Viewing Virtual Disks in a KVM Deployment

Use ODACLI commands or the Browser User Interface to view all virtual disks or details about a virtual disk in a KVM deployment.

Using ODACLI to View Virtual Disks

The command `odacli describe-vdisk` displays details about a virtual disk. Use the command `odacli list-vdisks` to view all virtual disks in the deployment.

```
# odacli list-vdisks
```

```
# odacli describe-vdisk -n vdisk_name
```

Using Browser User Interface to Create Virtual Disks

Follow these steps:

1. Log into the Browser User Interface:

```
https://host-ip-address:7093/mgmt/index.html
```

2. Click the **Appliance** tab.
3. Click **VM Instances** to display the VM Details page.
4. Click the **Show Virtual Disks** tab to view the list of all configured virtual disks.
5. Click on a virtual disk to view the details of the virtual disk.

Cloning a Virtual Disk in a KVM Deployment

Use ODACLI commands or the Browser User Interface to clone a virtual disk in a KVM deployment.

Using ODACLI to Clone Virtual Disks

Use the command `odacli clone-vdisk` to clone an existing virtual disk.

Specify the source `vdisk` from which you want to clone with the `-n` option, and specify the name of the cloned virtual disk with the `-cn` option.

Create a clone of a virtual disk named `vdisk1`, with the name `vdisk1_clone`. The cloned disk is created on the same storage as `vdisk1`.

```
# odacli clone-vdisk -n vdisk1 -cn vdisk1_clone
```

Using Browser User Interface to Create Virtual Disks

Follow these steps:

1. Log into the Browser User Interface:

```
https://host-ip-address:7093/mgmt/index.html
```

2. Click the **Appliance** tab.
3. Click **VM Instances** to display the Virtual Disk page.
4. Click **Create Virtual Disk**.
5. In the page, select the **Clone Virtual Disk** option and click **Next**.
6. In the Clone Virtual Disk page, specify the following:
 - Select the Source Virtual Disk you want to clone
 - Specify the name of the cloned virtual disk
7. Click **Create**.
8. When you submit the job, the job ID and a link to the job appears. Click the link to display the job status and details.
9. Validate that the job completed. You can track the job in the **Activity** tab in the Browser User Interface, or run the command `odacli describe-job` with the job ID.

Modifying a Virtual Disk in a KVM Deployment

Use ODA CLI commands or the Browser User Interface to modify a virtual disk in a KVM deployment.

Using ODA CLI to Modify Virtual Disks

Use the command `odacli modify-vdisk` to increase the size of a virtual disk.

Increase the size of a virtual disk named `vdisk1` by 4 gigabytes.

```
# odacli modify-vdisk -n vdisk1 -i 4G
```

Using Browser User Interface to Modify Virtual Disks

Follow these steps:

1. Log into the Browser User Interface:

```
https://host-ip-address:7093/mgmt/index.html
```

2. Click the **Appliance** tab.
3. Click **VM Instances** to display the VM Details page.

4. Click the **Show Virtual Disks** tab.
5. In the page, select a Virtual Disk, select the **Modify Virtual Disk** option and click **Next**.
6. In the Modify Virtual Disk page, specify Increment in size and if you want to share the virtual disk.
7. Click **Modify**.
8. When you submit the job, the job ID and a link to the job appears. Click the link to display the job status and details.
9. Validate that the job completed. You can track the job in the **Activity** tab in the Browser User Interface, or run the command `odacli describe-job` with the job ID.

Deleting a Virtual Disk in a KVM Deployment

Use ODACLI commands or the Browser User Interface to delete a virtual disk in a KVM deployment.

Using ODACLI to Delete Virtual Disks

Use the command `odacli delete-vdisk` to delete a virtual disk.

Delete a virtual disk named `vdisk1`.

```
# odacli delete-vdisk -n vdisk1
```

Using Browser User Interface to Modify Virtual Disks

Follow these steps:

1. Log into the Browser User Interface:

```
https://host-ip-address:7093/mgmt/index.html
```

2. Click the **Appliance** tab.
3. Click **VM Instances** to display the VM Details page.
4. Click the **Show Virtual Disks** tab.
5. In the page, select a Virtual Disk, select the **Delete** option.
6. Click Yes to confirm your choice.
7. When you submit the job, the job ID and a link to the job appears. Click the link to display the job status and details.
8. Validate that the job completed. You can track the job in the **Activity** tab in the Browser User Interface, or run the command `odacli describe-job` with the job ID.

Managing Virtual Machines in KVM Deployment

Use ODACLI to create, view, clone, modify, start, stop, and delete virtual machines in an Oracle Database Appliance KVM deployment.

- [Creating a Virtual Machine in a KVM Deployment](#)
Use ODACLI commands or the Browser User Interface to create a virtual machine in a KVM deployment.
- [Cloning a Virtual Machine in a KVM Deployment](#)
Use ODACLI commands or the Browser User Interface to clone a virtual machine instance in a KVM deployment.
- [Modifying a Virtual Machine in a KVM Deployment](#)
Use ODACLI commands or the Browser User Interface to modify a virtual machine in a KVM deployment.
- [Viewing Virtual Machines in a KVM Deployment](#)
Use ODACLI commands or the Browser User Interface to view all virtual machines or details about a virtual machine in a KVM deployment.
- [Starting and Stopping Virtual Machines in a KVM Deployment](#)
Use ODACLI commands or the Browser User Interface to start or stop virtual machines in a KVM deployment.
- [Deleting a Virtual Machine in a KVM Deployment](#)
Use ODACLI commands or the Browser User Interface to delete a virtual machine in a KVM deployment.

Creating a Virtual Machine in a KVM Deployment

Use ODACLI commands or the Browser User Interface to create a virtual machine in a KVM deployment.

Ensure that a VM storage exists before you create a VM instance.

Using ODACLI to Create Virtual Machine Instance

Use the command `odacli create-vm` to create a VM instance. Specify the preferred node on which to start the virtual machine after creation (`-pn` option).

Following is an example command to create a VM named `vm1` with 8 vcpus and 8 GB memory. The VM is stored in the VM Storage `vms1`. The source used for the installation is located on `/u01/OL7.iso`.

```
# odacli create-vm -n vm1 -c 8 -m 8G -vms vms1 -src /u01/OL7.iso
```

To use a kickstart configuration file to create the VM instance, include the file in the `--extra-args` parameter. Create a kickstart configuration file, including the network configuration for the guest VM. Ensure that the kickstart configuration file is available over the network that guest VM can access.

For example:

```
odacli create-vm --name odaksvm --memory 4G --source /u01/kvm/images/  
OL77_x86_64.iso --vmstorage myvms --size 10G --vcpus 2 --extra-args  
"console=tty0 console=ttyS0,115200 ks=http://test:portnumber/ks.txt"
```

If you do not use a kickstart configuration file to create the VM instance, then complete the VM instance creation as follows:

1. Run the `odacli create-vm` command and check that it completes successfully.

2. Use the `odacli describe-vm` command to check the VNC port.
3. Log in to the VM instance using the VNC port: `host:vncport`. See the section *Connecting to the VM instance Using VNC* for the steps to connect to the VM instance using VNC.
4. Complete the installation process by providing your values for the installation screens.
5. Log in again to the VM instance using the VNC port: `host:vncport`. See the section *Connecting to the VM instance Using VNC* for the steps to connect to the VM instance using VNC.
6. If you specified `--vnetwork` in the `odacli create-vm` command, then you can run `ifconfig -a` to view the network interface in the VM. Configure the network as you would on a Linux system.
7. After the network is configured, log into the VM using the network and customize the VM instance.
8. If you did not specify `--vnetwork` in the `odacli create-vm` command, then the VM network is created using the default Network Address Translation (NAT) based KVM bridge `virbr0`. `eth0` is configured as DHCP inside the VM.

Connecting to the VM instance Using VNC

Use either of the two methods to connect to the VM instance using VNC:

- Connect to VNC directly from your Oracle Database Appliance host as follows:
 1. Set the `DISPLAY` environment variable to a server where X Window System is running to run the VNC Viewer properly.
 2. Launch the VNC Viewer from the Oracle Database Appliance host where the VM instance is running.
 3. Enter the VNC port using the format `localhost:vncport`.
- Use SSH tunnel to access the VNC session as follows:
On Linux or macOS operating systems, use the following command:

```
ssh -L localport:localhost:vncport root@odahost
```

where *localport* is an available port number greater than 1024 on your local machine (for example, 12345) where VNC Viewer is launched. *vncport* is the VNC port returned from the `odacli describe-vm` command plus 5900. For example, if `odacli describe-vm` returns the VNC port as 1, then use 5901 as VNC port. *myodahost* is the host name of the Oracle Database Appliance host where the VM is running.

On Windows, Use PuTTY to create the SSH tunnel.

Using Browser User Interface to Create Virtual Machine Instance

Follow these steps:

1. Log into the Browser User Interface:

```
https://host-ip-address:7093/mgmt/index.html
```

2. Click the **Appliance** tab.

3. Click **Show VM Instances** to display the VM Instances page.
4. In the page, select the **Create VM Instance** option and click **Next**.
5. In the Create Virtual VM page, specify the following:
 - VM Name: Name assigned to the VM instance that is unique within the name repository
 - VM Storage Name: Name of the VM storage where the VM instance will be created
 - Source Installation: The source from which you want to create the VM
 - Preferred Node: Node where you want to run the VM instance
 - Memory Size: Size of the memory to be allocated
 - CPU Pool Name: Select the CPU Pool
 - Number of vCPUs to Use: Number of virtual CPUs to be allocated
6. Click **Create**.
7. When you submit the job, the job ID and a link to the job appears. Click the link to display the job status and details.
8. Validate that the job completed. You can track the job in the **Activity** tab in the Browser User Interface, or run the command `odacli describe-job` with the job ID.

Cloning a Virtual Machine in a KVM Deployment

Use ODACLI commands or the Browser User Interface to clone a virtual machine instance in a KVM deployment.

Using ODACLI to Clone Virtual Machine Instance

Use the command `odacli clone-vm` to clone an existing virtual machine.

The name of the VM you create is defined by the command `odacli clone-vm -cn name`. Specify the source VM from which you want to clone.

Create a clone of a virtual machine named `vm1`, with the name `vm1_clone`. The cloned VM is created on the same storage as `vm1`.

```
# odacli clone-vm -n vm1 -cn vm1_clone
```

Using Browser User Interface to Clone Virtual Machine Instance

Follow these steps:

1. Log into the Browser User Interface:

```
https://host-ip-address:7093/mgmt/index.html
```
2. Click the **Appliance** tab.
3. Click **VM Instances** to display the VM Instance page.
4. Click **Create VM Instance**.
5. In the page, select the **Clone VM Instance** option and click **Next**.

6. In the Clone VM Instance page, specify the following:
 - Select the Source VM you want to clone
 - Specify the name and description of the cloned VM instance
7. Click **Create**.
8. When you submit the job, the job ID and a link to the job appears. Click the link to display the job status and details.
9. Validate that the job completed. You can track the job in the **Activity** tab in the Browser User Interface, or run the command `odacli describe-job` with the job ID.

Modifying a Virtual Machine in a KVM Deployment

Use ODACLI commands or the Browser User Interface to modify a virtual machine in a KVM deployment.

Using ODACLI to Modify Virtual Machines

Use the command `odacli modify-vm` to modify a virtual machine.

Update the configuration of a VM named `vm1`, setting the CPU count to 6 and the maximum memory to 6 gigabytes on both the running VM and subsequent boots.

```
# odacli modify-vm -n vm1 -c 6 -mm 6G --live --config
```

Using Browser User Interface to Modify Virtual Machines

Follow these steps:

1. Log into the Browser User Interface:

```
https://host-ip-address:7093/mgmt/index.html
```

2. Click the **Appliance** tab.
3. Click **VM Instances** to display the VM Details page.
4. Click the **Show VM Instances** tab.
5. In the page, select a Virtual Machine, select the **Modify** option and click **Next**.
6. In the Modify VM page, specify Increment in size and if you want to Auto Start or Set Failover.
7. You can also modify the CPU Pool, Number of vCPUs to use, Memory Size, and attach and detach virtual disks and virtual networks.
8. Select if you want to save the configuration or apply the configuration to a running VM.
9. Click **Modify**.
10. When you submit the job, the job ID and a link to the job appears. Click the link to display the job status and details.
11. Validate that the job completed. You can track the job in the **Activity** tab in the Browser User Interface, or run the command `odacli describe-job` with the job ID.

Viewing Virtual Machines in a KVM Deployment

Use ODACLI commands or the Browser User Interface to view all virtual machines or details about a virtual machine in a KVM deployment.

Using ODACLI to View Virtual Machines

The command `odacli describe-vm` displays details about a virtual machine. Use the command `odacli list-vm` to view all virtual machines in the deployment.

```
# odacli list-vm
```

```
# odacli describe-vm -n vm_name
```

Using Browser User Interface to Create Virtual Machines

Follow these steps:

1. Log into the Browser User Interface:

```
https://host-ip-address:7093/mgmt/index.html
```

2. Click the **Appliance** tab.
3. Click **VM Instances** to display the VM Details page.
4. Click the **Show VM Instances** tab to view the list of all configured virtual machines.
5. Click on a VM Instance to view the details of the virtual machine.

Starting and Stopping Virtual Machines in a KVM Deployment

Use ODACLI commands or the Browser User Interface to start or stop virtual machines in a KVM deployment.

Using ODACLI to Start and Stop Virtual Machines

The command `odacli start-vm` starts a virtual machine. Use the command `odacli stop-vm` to stop a virtual machine in the deployment.

If `pref-node` is defined for the VM, then the VM starts on the `pref-node`. If `pref-node` is not defined for the VM, then the VM can start on any node, in a high-availability deployment. However, if you specify the node name `-n`, then the VM starts on the specified node, even if the preferred node is defined.

```
# odacli start-vm -n vm1
```

```
# odacli stop-vm -n vm1
```

Using Browser User Interface to Start and Stop Virtual Machines

Follow these steps:

1. Log into the Browser User Interface:

```
https://host-ip-address:7093/mgmt/index.html
```

2. Click the **Appliance** tab.
3. Click **VM Instances** to display the VM Details page.
4. Click the **Show VM Instances** tab to view the list of all configured virtual machines.
5. To start a virtual machine, click on a VM Instance, and then click **Start** and select the node to start the virtual machine.
6. To stop a virtual machine, click on a VM Instance, and then click **Stop** to stop the virtual machine. Click **Force Stop** to close all running processes and stop the virtual machine.

Deleting a Virtual Machine in a KVM Deployment

Use ODA CLI commands or the Browser User Interface to delete a virtual machine in a KVM deployment.

Using ODA CLI to Delete Virtual Machines

Use the command `odacli delete-vm` to delete a virtual machine.

Delete a virtual machine named `vm1`.

```
# odacli delete-vm -n vm1
```

Using Browser User Interface to Modify Virtual Machines

Follow these steps:

1. Log into the Browser User Interface:

```
https://host-ip-address:7093/mgmt/index.html
```

2. Click the **Appliance** tab.
3. Click **VM Instances** to display the VM Details page.
4. Click the **Show VM Instances** tab.
5. In the page, select a VM Instance, select the **Delete** option.
6. Click Yes to confirm your choice.
7. When you submit the job, the job ID and a link to the job appears. Click the link to display the job status and details.
8. Validate that the job completed. You can track the job in the **Activity** tab in the Browser User Interface, or run the command `odacli describe-job` with the job ID.

Example JSON File to Create a Single-Node DB System

Follow the JSON file example to create a JSON file to deploy a single-node DB System, with role separation, with the command `odacli create-dbsystem`.

Use the example JSON file to create a file for your environment.

Note:

It is important to review the readme and the examples carefully before creating your JSON file.

Example 13-1 JSON File to Create a Single-Node Oracle KVM Database System with Role Separation

The following is an example of a JSON file that creates a single-node Oracle KVM Database System on Oracle Database Appliance bare metal platform. The example uses role separation. When using the example to create your JSON file, change the definitions to match your environment. The password must meet password requirements.

```
{
  "system": {
    "name": "test_example",
    "shape": "odbl",
    "systemPassword": "WElcome12_-",
    "timeZone": "America/Los_Angeles",
    "diskGroup": "DATA",
    "enableRoleSeparation": true,
    "customRoleSeparation": {
      "groups": [
        {
          "name": "oinstall",
          "id": 1001,
          "role": "oinstall"
        },
        {
          "name": "dbaoper",
          "id": 1002,
          "role": "dbaoper"
        },
        {
          "name": "dba",
          "id": 1003,
          "role": "dba"
        },
        {
          "name": "asmadmin",
          "id": 1004,
          "role": "asmadmin"
        }
      ]
    }
  }
}
```

```

        "name": "asmoper",
        "id": 1005,
        "role": "asmoper"
    },
    {
        "name": "asmdba",
        "id": 1006,
        "role": "asmdba"
    }
],
"users": [
    {
        "name": "grid",
        "id": 1000,
        "role": "gridUser"
    },
    {
        "name": "oracle",
        "id": 1001,
        "role": "oracleUser"
    }
]
}
},
"database": {
    "name": "db19",
    "uniqueName": "db19",
    "domainName": "us.oracle.com",
    "adminPassword": "WELcome12_-",
    "version": "19.10.0.0.210119",
    "edition": "EE",
    "type": "SI",
    "dbClass": "OLTP",
    "shape": "odbl",
    "role": "PRIMARY",
    "targetNodeNumber": null,
    "enableDbConsole": false,
    "redundancy": null,
    "characterSet": {
        "characterSet": "AL32UTF8",
        "nlsCharacterSet": "AL16UTF16",
        "dbTerritory": "AMERICA",
        "dbLanguage": "ENGLISH"
    },
    "rmanBackupPassword": null,
    "enableTDE": false,
    "isCdb": false
},
"network": {
    "domainName": "test_domain",
    "ntpServers": [],
    "dnsServers": [
        "xx.xxx.xx.xxx"
    ],
    "nodes": [

```

```

        {
            "name": "node1",
            "ipAddress": "xx.xx.xx.xxx",
            "netmask": "xxx.xxx.xxx.x",
            "gateway": "xx.xx.xx.x",
            "number": 0
        }
    ]
},
"grid": {
    "language": "en"
}
}

```

Example JSON File to Create a High-Availability DB System

Follow the JSON file example to create a JSON file to deploy a two-node DB System, with role separation, with the command `odacli create-dbsystem`.

Use the example JSON file to create a file for your environment.

Example 13-2 JSON File to Create Two-Node Oracle KVM Database System with Role Separation

The following is an example of a JSON file that creates two-node Oracle KVM Database System on Oracle Database Appliance bare metal platform. The example uses role separation. When using the example to create your JSON file, change the definitions to match your environment. The password must meet password requirements.

```

{
  "system": {
    "name": "test_system",
    "shape": "odbl",
    "systemPassword": "WElcome12_-",
    "timeZone": "America/Los_Angeles",
    "diskGroup": "DATA",
    "enableRoleSeparation": true,
    "customRoleSeparation": {
      "groups": [
        {
          "name": "oinstall",
          "id": 1001,
          "role": "oinstall"
        },
        {
          "name": "dbaoper",
          "id": 1002,
          "role": "dbaoper"
        },
        {
          "name": "dba",
          "id": 1003,
          "role": "dba"
        }
      ]
    }
  }
}

```

```

        {
            "name": "asmadmin",
            "id": 1004,
            "role": "asmadmin"
        },
        {
            "name": "asmoper",
            "id": 1005,
            "role": "asmoper"
        },
        {
            "name": "asmdba",
            "id": 1006,
            "role": "asmdba"
        }
    ],
    "users": [
        {
            "name": "grid",
            "id": 1000,
            "role": "gridUser"
        },
        {
            "name": "oracle",
            "id": 1001,
            "role": "oracleUser"
        }
    ]
},
"database": {
    "name": "dbtest",
    "uniqueName": "dbtest",
    "domainName": "test_domain",
    "adminPassword": "WElcome12_-",
    "version": "19.10.0.0.210119",
    "edition": "SE",
    "type": "SI",
    "dbClass": "OLTP",
    "shape": "odbl",
    "role": "PRIMARY",
    "targetNodeNumber": "0",
    "enableDbConsole": false,
    "redundancy": null,
    "characterSet": {
        "characterSet": "AL32UTF8",
        "nlsCharacterSet": "AL16UTF16",
        "dbTerritory": "AMERICA",
        "dbLanguage": "AMERICAN"
    },
    "enableSEHA": true,
    "rmanBackupPassword": null,
    "enableTDE": false,
    "isCdb": false,
    "pdbName": ""
}

```

```
    "pdbAdminUser": "pdbadmin"
  },
  "network": {
    "domainName": "test_domain",
    "ntpServers": [],
    "dnsServers": [
      "xx.xxx.xx.xxx"
    ],
    "nodes": [
      {
        "name": "node1",
        "ipAddress": "xx.xx.xxx.xx",
        "netmask": "xxx.xxx.xxx.x",
        "gateway": "xx.xx.xxx.x",
        "number": 0,
        "vipName": "node1-vip",
        "vipAddress": "xx.xx.xxx.xx"
      },
      {
        "name": "node2",
        "ipAddress": "xx.xx.xxx.xx",
        "netmask": "xxx.xxx.xxx.x",
        "gateway": "xx.xx.xxx.x",
        "number": 1,
        "vipName": "node2-vip",
        "vipAddress": "xx.xx.xxx.xx"
      }
    ],
    "scanName": "test-scan",
    "scanIps": [
      "xx.xx.xxx.xx",
      "xx.xx.xxx.xx"
    ]
  },
  "grid": {
    "language": "en"
  }
}
```

Oracle Database Appliance Command-Line Interface

The command-line interface has different classes of tools to manage Oracle Database Appliance.

- [About Oracle Database Appliance Command-Line Interface](#)
Three classes of tools are available to perform deployment, lifecycle management, and system administration on Oracle Database Appliance.
- [Managing ODACLI Privileges and Security with SUDO](#)
Oracle Appliance Manager command-line utility requires `root` system privileges for most administration actions. You may want to use SUDO as part of your system auditing and security policy.
- [odacli Network Commands](#)
Use the `odacli network` commands to list and describe network interfaces.
- [odacli Apply Patch and Update Commands](#)
Use the commands `odacli update` and `apply patch` to apply patches and update the appliance.
- [odacli Appliance Commands](#)
Use the `odacli appliance` commands to perform lifecycle activities for the appliance.
- [odacli Backup and Recovery Commands](#)
Use the `odacli backup` and `recover` commands to backup to and restore from Oracle Cloud Infrastructure Object Storage or disk.
- [Oracle Data Guard odacli Commands](#)
Use ODACLI commands to configure and manage Oracle Data Guard in your Oracle Database Appliance deployment.
- [odacli CPU Core Commands](#)
Use the CPU Core commands to enable CPU cores and display current and historical CPU core configurations.
- [odacli CPU Pool Commands for Bare Metal and KVM](#)
Use `odacli` commands to manage resource allocations on Oracle Database Appliance for bare metal and KVM deployments.
- [odacli Database Commands](#)
Use the `odacli database` commands to perform database lifecycle operations.
- [odacli DBHome Commands](#)
Use the `odacli DBHome` commands to manage database Home operations.
- [odacli Database Storage Commands](#)
Use the Database Storage commands to list, describe, create, and delete Oracle database storage.
- [odacli Job Commands](#)
Use the `odacli list-jobs` and `odacli describe-job` commands to display job details.

- [Log Commands](#)
Use the `odacli log` commands to specify the options to collect and delete logs.
- [odacli Oracle Auto Service Request Commands](#)
Use the Oracle Auto Service Request (Oracle ASR) commands to configure, update, test, and delete Oracle ASR on the system.
- [odacli OS Commands](#)
Use the `odacli OS` commands to list and update operating system (OS) parameters.
- [odaadmcli Hardware Monitoring Commands](#)
Use the `hardware monitoring` commands to display hardware configurations.
- [Storage Commands](#)
Understand the commands to perform storage operations and diagnostics.

About Oracle Database Appliance Command-Line Interface

Three classes of tools are available to perform deployment, lifecycle management, and system administration on Oracle Database Appliance.

The command-line interface (CLI) is an alternative to Oracle Database Appliance Browser User Interface for some appliance configuration and patching tasks, database management, and job activity.

Oracle Database Appliance uses a role-based command-line interface. Use the `odacli` commands to perform lifecycle management tasks and the `odaadmcli` commands to perform storage and hardware monitoring maintenance. Many tasks related to managing Oracle Databases are also required with databases on Oracle Database Appliance. Tasks common to Oracle Database generally are described in the Oracle Database documentation library. However, to simplify tasks, use the Oracle Database Appliance command-line interface. The `odacli` and `odaadmcli` utilities combine the capabilities of the `SYS` database administrator role and the operating system Superuser (`root` user). Always perform administrative tasks using the Oracle Database Appliance Browser User Interface or CLI utilities.

The following classes of commands are available:

- **Deployment and Configuration:** Use the deployment and configuration commands as part of the initial deployment of the appliance and to configure CPU cores.
- **Lifecycle management:** Use `odacli` commands to perform database and system administration tasks for the appliance. The `odacli` commands are the primary interface to perform life cycle activities for the appliance.
- **Administration:** Use `odaadmcli` commands to perform hardware administration tasks for the appliance. The `odaadmcli` commands are the interface for infrequent administration activities needed to manage appliance hardware components, storage, and VLAN.

You can perform the following deployment and configuration tasks:

- Configure the first network in the appliance
- Unzip and copy the Oracle Database Appliance software to the correct locations
- Set the number of CPU Cores for the system

You can perform the following appliance lifecycle tasks with `odacli` commands:

- Create and describe the appliance
- Create, list, describe, and delete databases
- Create, list, describe, and delete Oracle Database Homes
- Create, list, and describe the networks
- List and describe the jobs

You can perform the following appliance administration tasks with `odaadmcli` commands:

- Show storage, disks, diskgroups, and controllers
- Display storage diagnostics for disks and NVMe Express (NVMe)s
- Show server, memory, processor, power, cooling, and network details

Depending on your version of Oracle Appliance Manager and your hardware, some of the `odacli` commands may not be available to you. To see which commands are supported on your version of Oracle Appliance Manager and your hardware, run the `odacli help` command: `odacli -h`.

Command-Line Interface Syntax

The command-line interface commands and parameters are case-sensitive.

An `odacli` or `odaadmcli` command uses the following command syntax:

```
odacli command [options]
```

- *command* is an action you want to perform on the appliance. For example: `odacli list-networks` or `odacli describe-jobs`.
- *options* are optional parts of the `odacli` command. Options can consist of one or more options that extend the use of the `odacli` command carried out on an object. Options include additional information about the action that you want to perform on the object. Option names are preceded with a dash. Some options require the name of an object for the command to perform the action that you want to carry out. If an option is preceded with an * (asterisk), this information is required to submit the command. When appending `-j` to the `odacli` command, the output is returned in JSON format. The help option (`-h`) is an option that is available with almost all commands. When you include the `-h` option, you can obtain additional information about the command that you want to perform.

Example 14-1 Command-Line Interface Syntax

```
# odacli create-database -h
```

```
Usage: create-database [options]
```

```
Options:
```

```
* --adminpassword, -m
    Password for SYS,SYSTEM and PDB Admin
--backupconfigid, -bi
    Backup Config ID
--cdb, -c
    Create Container Database (Inverse option: --no-cdb/--no-c)
--characterset, -cs
    Character Set (default:AL32UTF8)           Default: AL32UTF8
```

```

--databaseUniqueName, -u
    database unique name
--dbclass, -cl
    Database Class EE: OLTP/DSS/IMDB, SE: OLTP      Default: OLTP
--dbconsole, -co
    Enable Database Console (Inverse option: --no-dbconsole/-no-co)

--dbhomeid, -dh
    Database Home ID (Use Existing DB Home)
--dblanguge, -l
    Database Language (default:AMERICAN)          Default: AMERICAN
* --dbname, -n
    Database Name
--dbshape, -s
    Database Shape{odbls,odbl,odb2,etc.}         Default: odb1
--dbstorage, -r
    Database Storage {ACFS|ASM}                   Default: ACFS
--dbterritory, -dt
    Database Territory (default:AMERICA)         Default: AMERICA
--dbtype, -y
    Database Type: SI                             Default: SI
--help, -h
    get help
--instanceonly, -io
    Create Instance Only (For Standby)
--json, -j
    json output
--nlscharacterst, -ns
    NLS Character Set (default:AL16UTF16)        Default: AL16UTF16
--no-cdb, -no-c
    Won't create Container Database (Inverse option: --cdb/-c)
--no-dbconsole, -no-co
    Disable Database Console (Inverse option: --dbconsole/-co)
--pdbadmin, -d
    Pluggable Database Admin User
--pdbname, -p
    Pluggable Database Name
--version, -v
    Database Version

```

Oracle Database Appliance Manager Command-Line Interface Help

Run the `-h` command to see the usage information for all commands available for your Oracle Database Appliance. For example:

```
odacli -h
```

Run `odacli command -h` or `odacliadm command -h` to see detailed help about a specific command. For example, to see detailed help for the `odacli describe-dbhome` command, use the following:

```
odacli describe-dbhome -h
```

Managing ODACLI Privileges and Security with SUDO

Oracle Appliance Manager command-line utility requires `root` system privileges for most administration actions. You may want to use SUDO as part of your system auditing and security policy.

For most tasks, Oracle recommends that you log in as `root` to use the Oracle Appliance Manager command-line interface on Oracle Database Appliance. If you are not logged in as `root`, then you cannot carry out most actions on the appliance. For example, if you are not logged in as `root`, then you can view storage information, but you cannot modify the storage.

Allowing Root User Access Using SUDO

In environments where system administration is handled by a different group than database administration, or where security is a significant concern, you may want to limit access to the `root` user account and password. SUDO enables system administrators to grant certain users (or groups of users) the ability to run commands as `root`, while logging all commands and arguments as part of your security and compliance protocol.

A SUDO security policy is configured by using the file `/etc/sudoers`. Within the `sudoers` file, you can configure groups of users and sets of commands to simplify and audit server administration with SUDO commands.

Caution:

Configuring SUDO to allow a user to perform any operation is equivalent to giving that user `root` privileges. Consider carefully if this is appropriate for your security needs.

Example 14-2 SUDO Example 1: Allow a User to Perform Any ODACLI Operation

This example shows how to configure SUDO to enable a user to perform any ODACLI operation. You do this by adding lines to the commands section in the `/etc/sudoers` file:

```
## The commands section may have other options added to it.
##
Cmd_Alias ODACLI_CMDS=/opt/oracle/dcs/bin/odacli *
jdoe ALL = ODACLI_CMDS
```

In this example, the user name is `jdoe`. The file parameter setting `ALL= ODACLI_CMDS` grants the user `jdoe` permission to run all `odacli` commands that are defined by the command alias `ODACLI_CMDS`. After configuration, you can copy one `sudoers` file to multiple hosts. You can also create different rules on each host.

 **Note:**

Before database creation, you must set up user equivalency with SSH for the root user on each server. If you do not set up user equivalency and configure SSH on each server, then you are prompted to provide the root password for each server during database creation.

After you configure the `sudoer` file with the user, the user `jdoe` can run the set of `odacli` commands configured with the command alias `ODACLI_CMDS`. For example:

```
odacli create-database --dbname newdb -m
Enter new 'SYS, SYSTEM and PDB Admin user' password:
Confirm 'SYS, SYSTEM and PDB Admin user' password:

Job details
-----
                ID: 1bc31577-f910-4d3f-b6ff-8e3fccd30141
Description: Database service creation with db name: newdb
      Status: Created
    Created: November 30, 2018 9:23:57 AM PST
    Message:
```

```
Task Name Start Time End Time Status
-----
```

Example 14-3 SUDO Example 2: Allow a User to Perform Only Selected ODACLI Operations

To configure SUDO to allow a user to perform only selected ODACLI operations, add lines to the commands section in the `/etc/sudoers` file as follows:

```
## DCS commands for oracle user
Cmnd_Alias DCSCMDS = /opt/oracle/dcs/bin/odacli describe-appliance
oracle ALL=          DCSCMDS
```

```
$ sudo /opt/oracle/dcs/bin/odacli describe-appliance
```

```
Appliance Information
-----
                ID: a977bb04-6cf0-4c07-8e0c-91a8c7e7ebb8
      Platform: OdaliteL
Data Disk Count: 6
  CPU Core Count: 20
    Created: October 24, 2017 6:51:52 AM HDT
```

```
System Information
-----
                Name: systeml001
      Domain Name: example.com
    Time Zone: America/Adak
    DB Edition: EE
```

```
DNS Servers: 10.200.76.198 10.200.76.199 192.0.2.254
NTP Servers: 10.200.0.1 10.200.0.2
```

Disk Group Information

DG Name	Redundancy	Percentage
Data	Normal	90
Reco	Normal	10

In this example, the user `jdoue2` tries to run the `sudo odacli list-databases` command, which is not part of the set of commands that is configured for that user. SUDO prevents `jdoue2` from running the command.

```
[jdoue2@servernode1 ~]$ sudo /opt/oracle/dcs/bin/odacli list-databases
```

```
Sorry, user jdoue2 is not allowed to execute '/opt/oracle/dcs/bin/odacli
list-databases' as root on servernode1.
```

odacli Network Commands

Use the `odacli network` commands to list and describe network interfaces.

- [odacli configure-firstnet](#)
Use the command `configure-firstnet` to configure the first network in the appliance after racking and connecting the power and network cables.
- [odacli create-network](#)
Use the `odacli create-network` command to create a network.
- [odacli delete-network](#)
Use the command `odacli delete-network` to delete a network.
- [odacli delete-networkinterface](#)
Use the command `odacli delete-networkinterface` to delete a network interface on Oracle Database Appliance X8-2 hardware models.
- [odacli describe-network](#)
Use the `odacli describe-network` command to display the details of a specific network.
- [odacli describe-networkinterface](#)
Use the `odacli describe-networkinterface` command to display the details of any network interface.
- [odacli list-networks](#)
Use the `odacli list-networks` command to display networks.
- [odacli list-networkinterfaces](#)
Use the `odacli list-networkinterfaces` command to display network interfaces.
- [odacli update-network](#)
Use the `odacli update-network` command to update an existing network configuration.

odacli configure-firstnet

Use the command `configure-firstnet` to configure the first network in the appliance after racking and connecting the power and network cables.

File Path

```
/opt/oracle/dcs/bin/odacli
```

Syntax

```
# /opt/oracle/dcs/bin/odacli configure-firstnet
```

Usage Notes

This command ensures that the system is available in the network, enabling you to manage the deployment through the Oracle Appliance Manager Browser User Interface.

- Bonded network configuration: Bonded dual-ported interface. With the bonded configuration, you can only enable one of the interfaces. The bonded configuration supports VLANs. The bonded network configuration uses `btbond1` on Oracle Database Appliance hardware models other than X8-2. On Oracle Database Appliance X8-2, the bonded network configuration uses `btbond1` to `btbond6`. This is the default setting.
- Non-bonded network configuration (on Oracle Database Appliance hardware models other than X8-2): Two separate physical network interfaces, this configuration does not support VLANs. The non-bonded network configuration uses `em2` and `em3` as public interfaces. Note that Oracle Database Appliance X8-2 does not support non-bonded network configuration.
- To change a non-bonded network configuration to a bonded configuration, run the Oracle Database Appliance Cleanup Script and redeploy the appliance.

Example 14-4 Configuring the First Network as a Bonded Network

Configure the first network to use a `btbond1` interface without configuring DHCP. Complete the IP address, netmask address, and gateway address.

Values that you need to provide are shown in *italic font*, with the exception of the `net1` gateway address; the program obtains the gateway IP address. The program derives this gateway address using the network information you provided for the other IP addresses. Accept this value, unless your network administrator provides an alternative gateway address that is different from the default that the appliance command-line interface detects.

The following is an example of the command on a single node platform:

```
# /opt/oracle/dcs/bin/odacli configure-firstnet

Select the Interface to configure the network on (btbond1): btbond1
Configure DHCP on btbond1 (yes/no): no
INFO: You have chosen Static configuration
Enter the IP address to configure: 10.1.10.2
Enter the Netmask address to configure: 255.255.255.0
```

```
Enter the Gateway address to configure: 10.1.10.1
INFO: Plumbing the IPs now
INFO: Restarting the network
Shutting down interface btbond1: bonding: btbond1: Removing slave em2.
bonding: btbond1: releasing active interface em2
bonding: btbond1: making interface em3 the new active one.
bonding: btbond1: Removing slave em3.
bonding: btbond1: releasing active interface em3
:~::~~::~~::
```

Example 14-5 Configuring the First Network as a Non-Bonded Network

The following is an example of a non-bonded configuration. For a non-bonded configuration, answer `no` to using a bonding public interface. Note that Oracle Database Appliance X8-2 does not support non-bonded network configuration.

```
# /opt/oracle/dcs/bin/odacli configure-firstnet
Using bonding public interface (yes/no) [yes]: no
INFO: Breaking the bonding on btbond1
INFO: remove bonding module: rmmmod bonding
INFO: remove slave setup in /etc/sysconfig/network-scripts/ifcfg-em2
INFO: remove slave setup in /etc/sysconfig/network-scripts/ifcfg-em3
INFO: Restarting the network
Shutting down interface em1: [ OK ]
Shutting down loopback interface: [ OK ]
Bringing up loopback interface: [ OK ]
Bringing up interface em1: [ OK ]
Bringing up interface em2: [ OK ]
Bringing up interface em3: [ OK ]
INFO: Restarting the DCS agent
initdcsagent stop/waiting
initdcsagent start/running, process 57629
Select the Interface to configure the network on (em2 em3) [em2]:
Configure DHCP on em2 (yes/no) [no]:
INFO: You have chosen Static configuration
Enter the IP address to configure : 10.31.102.101
Enter the Netmask address to configure : 255.255.240.0
Enter the Gateway address to configure[10.31.96.1] :
INFO: Plumbing the IPs now
INFO: Restarting the network
Shutting down interface em1: [ OK ]
Shutting down interface em2: [ OK ]
Shutting down interface em3: [ OK ]
Shutting down loopback interface: [ OK ]
Bringing up loopback interface: [ OK ]
Bringing up interface em1: [ OK ]
Bringing up interface em2: Determining if ip address 10.31.102.101 is
already in use for device em2...
[ OK ]
Bringing up interface em3: [ OK ]
```

odacli create-network

Use the `odacli create-network` command to create a network.

File Path

`/opt/oracle/dcs/bin/odacli`

Syntax

```
odacli create-network [-d|-no-d] -n interface -p ipaddress -w {Public|
Dataguard|Database|Management|Backup|Other} -s subnetmask -g
gateway[-h] [-sip] [-sn] [-vs] [-j]
```

Parameters

Parameter	Description
<code>--defaultnetwork, -d</code>	Identifies the default network.
<code>--gateway, -g</code>	Defines the network gateway. The gateway is required for the default network.
<code>--help, -h</code>	(Optional) Displays help for using the command.
<code>--interface, -n</code>	Defines the name of the network interface.
<code>--interfacetype, -t</code>	Defines the network interface type {BOND PHYSICAL VLAN INTERNAL} (non case-sensitive).
<code>--ipaddress, -p</code>	Defines the network IP address. This can be specified in the format <code>IPAddress</code> or <code>nodeNumber0:IPAddress0,nodeNumber1:IPAddress1,..</code> .
<code>--json, -j</code>	(Optional) Displays JSON output.
<code>--networktype, -w</code>	Defines the type of network. Options are: {Public Dataguard Database Management Backup Other}. The default is Other.
<code>--name, -m</code>	Name of the network.
<code>--no-defaultnetwork, no-d</code>	Identifies a network as not the default network. Use <code>--defaultnetwork -d</code> to identify a default network.
<code>--subnetmask, -s</code>	Defines the Network Subnet Mask.
<code>--scanips, -sip</code>	Defines the SCAN IP addresses (in the format <code>scanip0,scanip1,..</code>)
<code>--scanname, -sn</code>	Defines the SCAN name.
<code>--nodeNumber, -u</code>	Defines the node number for High-Availability deployments. Note: This option is deprecated and will be desupported in a future release.
<code>--vips, -vs</code>	List of virtual IP addresses. They can be specified in the format <code>vipname0:nodeNumber0:vip0,vipname1:nodenumber1:vip1,..</code>
<code>--vlanid, -v</code>	Add VLAN as a new network. This option is available for for High-Availability deployments.

Usage Notes

- Network of `public` type can only be defined when deploying the appliance or when running `odacli configure-firstnet` during initial provisioning.
- Use this command to create an additional network not done in `create-appliance`.
- You are only allowed to create a network on the bond interface.
- On Oracle Database Appliance non-High Availability systems, you cannot specify Virtual IP addresses. The Virtual IP address is set to the same value as the IP address.
- Single Client Access Name (SCAN) cannot be set up on Oracle Database Appliance non-High Availability systems.

Example 14-6 Creating a Network

The following example creates a new network, `sfpbond1`, with IP address `192.0.2.15`. The network is an additional network that uses subnet mask `255.255.255.0` and is not a default network.

```
# odacli create-network -n sfpbond1 -p 192.0.2.15 -w Backup -s
255.255.255.0 -no-d
```

Example 14-7 Creating a VLAN Network

```
odacli create-network -g 10.31.131.129 -n btbond1 -t
VLAN -p 0:10.31.131.132,1:10.31.131.133 -m vlan150 -w
Database -no-d -sip 10.31.131.134,10.31.131.135 -sn scaoda702c1-
vlan150-scan -s 255.255.255.128 -vs scaoda702c1n1-vlan150-
vip:0:10.31.131.136,scaoda702c1n2-vlan150-vip:1:10.31.131.137 -v 150
```

odacli delete-network

Use the command `odacli delete-network` to delete a network.

File Path

```
/opt/oracle/dcs/bin/odacli
```

Syntax

To delete a network:

```
odacli delete-network -i id [-m] [-h] [-j]
```

Parameters

Parameter	Description
<code>--id, -i</code>	Defines the network identity.
<code>--name, -m</code>	Specifies the network name.
<code>--json, -j</code>	(Optional) Displays JSON output.

Parameter	Description
--help, -h	(Optional) Displays help for using the command.

Usage Notes

You cannot delete the Public-network or Private-network after the system is deployed.

On High-Availability systems, if the node number is not specified in the `odacli delete-network` command, then the network on both nodes is deleted.

Example 14-8 Deleting a Network

The following example deletes a backup network with a network ID of 55db39db-d95c-42c5-abbd-b88eb99b83ec.

```
# odacli delete-network -i 55db39db-d95c-42c5-abbd-b88eb99b83ec
```

```
"jobId" : "c26d217e-419b-4a91-8680-7b06bcfe9828",
"status" : "Running",
"message" : null,
"reports" : [ {
  "taskId" : "TaskSequential_137",
  "taskName" : "deleting network",
  "taskResult" : "Running",
  "startTime" : "January 8, 2021 23:14:32 PM EDT",
  "endTime" : "January 8, 2021 23:14:32 PM EDT",
  "status" : "Running",
  "taskDescription" : null,
  "parentTaskId" : "TaskSequential_135",
  "jobId" : "c26d217e-419b-4a91-8680-7b06bcfe9828",
  "tags" : [ ],
  "reportLevel" : "Info",
  "updatedAt" : "January 8, 2021 23:14:32 PM EDT"
},{
  "taskId" : "TaskZJsonRpcExt_142",
  "taskName" : "Setting up Network",
  "taskResult" : "Network setup success",
  "startTime" : "January 8, 2021 23:14:32 PM EDT",
  "endTime" : "January 8, 2021 23:14:32 PM EDT",
  "status" : "Success",
  "taskDescription" : null,
  "parentTaskId" : "TaskParallel_141",
  "jobId" : "c26d217e-419b-4a91-8680-7b06bcfe9828",
  "tags" : [ ],
  "reportLevel" : "Info",
  "updatedAt" : "January 8, 2021 23:14:32 PM EDT" } ],
"createTimestamp" : "January 8, 2021 23:14:32 PM EDT",
"description" : "Network service delete",
"updatedAt" : "January 8, 2021 23:14:32 PM EDT"
}
```

odacli delete-networkinterface

Use the command `odacli delete-networkinterface` to delete a network interface on Oracle Database Appliance X8-2 hardware models.

File Path

```
/opt/oracle/dcs/bin/odacli
```

Syntax

To delete a network interface:

```
odacli delete-networkinterface id [-h]
```

Parameters

Parameter	Description
<code>-id</code>	Defines the network interface name.
<code>--help, -h</code>	(Optional) Displays help for using the command.

Usage Notes

You cannot delete the network interface card in slot 7.

Example 14-9 Deleting a Network Interface

```
[root@oak ~]/opt/oracle/dcs/bin/odacli delete-networkinterface -m
btbond4
{
  "jobId" : "a81066e2-417e-4df6-b810-08df24c646c1",
  "status" : "Running",
  "message" : null,
  "reports" : ,
  "createTimestamp" : "January 8, 2021 00:01:09 AM UTC",
  "resourceList" : ,
  "description" : "Network Interface Deletion with name btbond4",
  "updatedAtTime" : "January 8, 2021 00:01:09 AM UTC"
}
```

Example 14-10 Deleting btbond1 Network Interface is Not Allowed

```
[root@oak ~]# /opt/oracle/dcs/bin/odacli delete-networkinterface -m
btbond1
DCS-10001:Internal error encountered: Delete operation is not allowed
on network interface : btbond1.
```

Example 14-11 Deleting Network Interface When Network Exists is Not Allowed

```
[root@oak ~]# opt/oracle/dcs/bin/odacli delete-networkinterface -m
btbond3
```

```
DCS-10001:Internal error encountered: Delete operation is not allowed
- networks {[Public-network]} found on interface btbond3. Please delete
the network first.
```

odacli describe-network

Use the `odacli describe-network` command to display the details of a specific network.

File Path

```
/opt/oracle/dcs/bin/odacli
```

Syntax

To display the details of a specific network:

```
odacli describe-network -i id [-j][-u][-h]
```

Parameters

Parameter	Description
<code>--id, -i</code>	Identifies the network ID. Use the <code>odacli list-networks</code> command to obtain the id.
<code>--json, -j</code>	(Optional) Displays JSON output.
<code>--help, -h</code>	(Optional) Displays help for using the command.
<code>--name, -m</code>	Specifies the network name.
<code>--nodeNumber, -u</code>	(Optional) Displays the network interface information for the specified node. Note: This option is deprecated and will be desupported in a future release.

Example 14-12 Displaying Network Details

Enter the following command to display the details of the public network:

```
# odacli describe-network -m Public-network
```

```
Network details
```

```
-----
                ID:  a11573f1-cad4-41fc-9dd0-3ba958b605f8
                Name:  Public-network
                NIC:   btbond1
Interface Type:  BOND
Subnet Mask:    255.255.255.0
Gateway:       10.31.116.1
VLAN ID:
                Type:  Public
                Default: true
                Created: March 30, 2020 8:37:00 AM PDT
                Updated: March 30, 2020 10:25:27 AM PDT
                Status: Configured
Node Networks:  [IP Address on node0: 10.31.117.60, IP
```

```
Address on node1: 10.31.117.62]
      Scan Name: scaodal-scan
      Scan Ips:  10.31.117.64 10.31.117.65
      Vips: [scaodal-vip on node0: 10.31.116.61, scaoda2-
vip on node1: 10.31.116.63]
      Associated Databases: odacn db122a db122b db122c db122d
```

Example 14-13 Displaying Network Details

Enter the following command to display the details of network ID 93c07043-3002-494a-8fa0-f3ae932fb4c5:

```
# odacli describe-network -i 93c07043-3002-494a-8fa0-f3ae932fb4c5 -u 1
```

Network details

```
-----
      ID: 93c07043-3002-494a-8fa0-f3ae932fb4c5
      Name: Private-network
      NIC: ibbond0
InterfaceType: BOND
      IP Address: 192.168.16.25
      Subnet Mask: 255.255.255.0
      Gateway:
      VlanId:
      Type: Private
      Default: false
      Created: November 18, 2018 10:54:16 PM PST
```

odacli describe-networkinterface

Use the `odacli describe-networkinterface` command to display the details of any network interface.

File Path

```
/opt/oracle/dcs/bin/odacli
```

Syntax

To display the details of a specific network interface:

```
odacli describe-networkinterface -i id [-j][-h][-u]
```

Parameters

Parameter	Description
<code>--id, -i</code>	Identifies the network interface ID. Use the <code>odacli list-networks</code> command to obtain the id.
<code>--json, -j</code>	(Optional) Displays JSON output.
<code>--help, -h</code>	(Optional) Displays help for using the command.

Parameter	Description
<code>--nodeNumber, -u</code>	(Optional) Displays the network interface information for the specified node. Note: This option is deprecated and will be desupported in a future release.

Usage Notes

By default, this command always displays the network interface description of the local node. To display the description of another node, specify the node number option (-u).

Example 14-14 Displaying Network Details

Enter the following command to display the details of network interface with ID fe1bf0a7-f56e-44cd-9a84-f374c0aa4b61:

```
# /opt/oracle/dcs/bin/odacli describe-networkinterface
-i fe1bf0a7-f56e-44cd-9a84-f374c0aa4b61 -u 1
```

Network Interface details

```
-----
                ID: fe1bf0a7-f56e-44cd-9a84-f374c0aa4b61
                Name: eth2
                NIC: eth2
                Type: PHYSICAL
                Members: eth2
Slave Interface: true
                Created: October 16, 2018 1:16:59 PM PDT
```

odacli list-networks

Use the `odacli list-networks` command to display networks.

File Path

```
/opt/oracle/dcs/bin/odacli
```

Syntax

```
odacli list-networks [-j] [-h]
```

Parameters

Parameter	Description
<code>--json, -j</code>	(Optional) Displays JSON output.
<code>--help, -h</code>	(Optional) Displays help for using the command.
<code>--nodeNumber, -u</code>	(Optional) Displays the network interface information for the specified node. Note: This option is deprecated and will be desupported in a future release.

Example 14-15 Displaying a List of Networks

Use the `odacli list-networks` command to display a list of networks:

```
# odacli list-networks
ID Name NIC Interface Type Subnet Mask Gateway VLAN ID Node Networks
-----
-----
30012eeb-1205-4cb6-9fc0-488972b2e420 Private-network priv0 INTERNAL
255.255.255.240 [IP Address on node0: 192.168.16.24]
75d01d4f-e940-4d0f-a4fe-ee04f5a90c73 Public-network btbond1.370 VLAN
255.255.255.0 10.209.10.241 370 [IP Address on node0: 10.209.10.244]
```

odacli list-networkinterfaces

Use the `odacli list-networkinterfaces` command to display network interfaces.

File Path

```
/opt/oracle/dcs/bin/odacli
```

Syntax

```
odacli list-networkinterfaces [-j] [-h] [-u]
```

Parameters

Parameter	Description
<code>--json, -j</code>	(Optional) Displays JSON output.
<code>--help, -h</code>	(Optional) Displays help for using the command.
<code>--nodeNumber, -u</code>	(Optional) Displays the network interface information for the specified node. Note: This option is deprecated and will be desupported in a future release.

Example 14-16 Displaying a List of Network Interfaces

Use the `odacli list-networkinterfaces` command to display a list of network interfaces:

```
# odacli list-networkinterfaces -u 1
ID Name
NIC Type
-----
d5907a23-1c5d-48c7-8d47-2c188ed43ddd bond0
bond0 BOND
4f7ea558-9a43-42a9-8e08-6bdfd3a33229 bond1
bond1 BOND
743ced8d-bbe5-4987-b316-5fdf95d5e60b eth0
eth0 PHYSICAL
a4121f9e-e694-4852-a521-44efc6ef3fde eth1
```



```

eth1          PHYSICAL
c62c5f04-aa93-4783-a3a7-275bf9fab2d9    eth2
eth2          PHYSICAL
bda21dad-5c1c-4073-89e5-798b8fce8533    eth3
eth3          PHYSICAL
0141f1ac-5c34-4393-8b99-76094b6f795c    ib0
ib0           PHYSICAL
e8cb138a-087f-4739-bb8d-90b1d903aeb6    ib1
ib1           PHYSICAL
a31cfd63-fb90-4cbb-a2fb-382c5e33983b    ibbond0
ibbond0      BOND

```

odacli update-network

Use the `odacli update-network` command to update an existing network configuration.

File Path

```
/opt/oracle/dcs/bin/odacli
```

Syntax

To update a network:

```

odacli update-network -i id [-p IP address] [-w {Public|Dataguard|
Database|Management|Backup|Other} ] [-s network subnet mask] [-g
network gateway] [-sip] [-sn] [-vs]
[-j] [-h]

```

Parameters

Parameter	Description
<code>--id, -i</code>	Defines the network identity.
<code>--gateway, -g</code>	(Optional) Defines the network gateway.
<code>--ipaddress, -p</code>	(Optional) Defines the network IP address. This can be specified in the format <code>IPAddress</code> or <code>nodeNumber0:IPAddress0,nodeNumber1:IPAddress1,...</code>
<code>--json, -j</code>	(Optional) Displays JSON output.
<code>--networktype, -w</code>	(Optional) Defines the type of network. {Public Dataguard Database Management Backup Other}
<code>--scanips, -sip</code>	Defines the SCAN IP addresses (in the format <code>scanip0,scanip1,...</code>)
<code>--scanname, -sn</code>	Defines the SCAN name.
<code>--subnetmask, -s</code>	(Optional) Defines the Network Subnet Mask.
<code>--vips, -vs</code>	List of virtual IP addresses. They can be specified in the format <code>vipname0:nodeNumber0:vip0,vipname1:nodenummer1:vip1</code>
<code>--help,-h</code>	(Optional) Displays help for using the command.

Usage Notes

- You cannot modify the Public and Private-interfaces after the system is deployed.
- On Oracle Database Appliance non-High Availability systems, you cannot update Virtual IP addresses. The Virtual IP address is set to the same value as the IP address.
- Single Client Access Name (SCAN) cannot be set up on Oracle Database Appliance non-High Availability systems.
- On Oracle Database Appliance High Availability systems, you cannot update network of type Database to other types of network (such as backup, management and so on). You can, however, update IP address, Virtual IP address, Gateway, and Subnet mask for all network types.
- The system has both SFP+ and 10GBaseT bonded pairs, which means that one of them is used for the public, and you can configure the other after deployment if you want additional connectivity. For example, if you want a backup network.

Example 14-17 Updating a Network

The following example updates network ID 192.0.0.2 and designates the network as a backup network:

```
# odacli update-network -i 192.0.0.2 -w Backup
```

odacli Apply Patch and Update Commands

Use the commands `odacli update` and `apply patch` to apply patches and update the appliance.

- [odacli cleanup-patchrepo](#)
Use the `odacli cleanup-patchrepo` command to delete obsolete or old patches from the repository.
- [odacli create-prepatchreport](#)
Use the `odacli create-prepatchreport` command to run pre-checks for patching.
- [odacli delete-agentconfig-parameters](#)
Use the `odacli delete-agentconfig-parameters` command to delete configuration variables used by the appliance.
- [odacli delete-prepatchreport](#)
Use the `odacli delete-prepatchreport` command to delete any pre-check report.
- [odacli describe-component](#)
Use the `odacli describe-component` command to display the installed version and the latest available version for each component.
- [odacli describe-latestpatch](#)
Use the `odacli describe-latestpatch` command to display a list of the latest supported patch versions for each component.
- [odacli describe-prepatchreport](#)
Use the `odacli describe-prepatchreport` command to display the pre-check report, with a list of pre-checks run with status and comments.

- [odacli list-agentconfig-parameters](#)
Use the `odacli list-agentconfig-parameters` command to list configuration variables used by the appliance.
- [odacli list-availablepatches](#)
Use the `odacli list-availablepatches` command to display all available patches for Oracle Database Appliance.
- [odacli list-prepatchreports](#)
Use the `odacli list-prepatchreports` command to display all pre-check reports, with a list of pre-checks run with status and comments.
- [odacli update-agentconfig-parameters](#)
Use the `odacli update-agentconfig-parameters` command to modify configuration variables used by the appliance.
- [odacli update-dbhome](#)
Use the `odacli update-dbhome` command to update a specific RDBMS Home to the latest patch bundle version.
- [odacli update-dcsadmin](#)
Use the `odacli update-dcsadmin` command to update the DCS admin components for Zookeeper upgrade.
- [odacli update-dcsagent](#)
Use the `odacli update-dcsagent` command to update the agent.
- [odacli update-dcscomponents](#)
Use the `odacli update-dcscomponents` command to update the DCS components such as the DCS agent and Zookeeper.
- [odacli update-registry](#)
Use the `odacli update-registry` command to update the registry of components when you apply patches manually.
- [odacli update-repository](#)
Use the `odacli update-repository` command to update the repository with the new Oracle Database Appliance software.
- [odacli update-server](#)
Use the `odacli update-server` command to update the operating system, firmware, Oracle Appliance Kit, Oracle Clusterware, and all other infrastructure components.
- [odacli update-storage](#)
Use the `odacli update-storage` command to update the storage.
- [odaadmcli orachk](#)
Use the `odaadmcli orachk` command to check configuration settings for Oracle Database Appliance components.

odacli cleanup-patchrepo

Use the `odacli cleanup-patchrepo` command to delete obsolete or old patches from the repository.

File Path

`$ORACLE_HOME/opt/oracle/dcs/bin/odacli`

Syntax

```
odacli cleanup-patchrepo [-cl clones] | [-v version [-comp component]] |
[-l local|-n NodeID]
```

Parameters

Parameter	Description
--clones, -cl	Specifies the option to clean up clone files (DB and GI) from the repository <code>/opt/oracle/oak/pkgrepos/orapkgs/clones/</code> .
--version, -v	Defines the Oracle Database Appliance release you want to delete. For example, 12.2.1.4.0.
--component, -comp	A comma-separated list of components as {DB,GI} to cleanup for a specific Oracle Database Appliance patch version. The default is both {DB,GI}.
--local, -l	(Optional) Cleans up the repository on the local node.
--node, -n	(Optional) Cleans up the repository on the specified nodes.
--help, -h	(Optional) Displays help for using the command.
--json, -j	(Optional) Displays JSON output.

Usage Notes

- Use the command to free up space in the patch repository.
- This command does not delete the current patches or latest installed patch repository.

Example 14-18 Deleting RDBMS and GI components for a specific release

```
# odacli cleanup-patchrepo -cl -comp db,gi -v 12.2.1.4.0
{
"jobId" : "d915ffc0-c7f6-49cf-8ddd-ab5d2ad9072f",
"status" : "Created",
"message" : null,
"reports" : ,
"createTimestamp" : "April 17, 2019 06:44:28 AM UTC",
"resourceList" : ,
"description" : "Cleanup patchrepos",
"updatedAtTime" : "April 17, 2019 06:44:28 AM UTC"
```

Example 14-19 Deleting Clone Files

```
# odacli cleanup-patchrepo -cl
{
"jobId" : "5d8549a2-1a5e-4b4f-9867-clf671c659c4",
"status" : "Created",
"message" : null,
"reports" : ,
"createTimestamp" : "April 17, 2019 06:43:45 AM UTC",
```

```

"resourceList" : ,
"description" : "Cleanup patchrepos",
"updatedAtTime" : "April 17, 2019 06:43:45 AM UTC"
}

```

odacli create-prepatchreport

Use the `odacli create-prepatchreport` command to run pre-checks for patching.

Patching pre-checks help identify and remedy any problems before patching is attempted, and ensure all components are ready for updates.

File Path

```
/opt/oracle/dcs/bin/odacli
```

Syntax

```
odacli create-prepatchreport [-d] [-i] [-f] [-l] [-n] [-v] [-h] [-s]
[-r] [-st] [-sko] [-c os [-local]]
```

Parameters

Parameter	Description
<code>--dbhome, -d</code>	(Optional) Specifies the database home component for running the pre-checks.
<code>--dbhomeid, -i</code>	(Optional) Specifies the IDs of the database homes for running the pre-checks.
<code>--files, -f</code>	(Optional) Specifies files required to update repository, comma-separated if multiple files are required.
<code>--help, -h</code>	(Optional) Displays help for using the command.
<code>--json, -j</code>	(Optional) Displays JSON output. The default is false.
<code>--local, -l</code>	(Optional) Runs patch pre-checks only on the local node.
<code>--operating-system, -os</code>	(Optional) Specifies the operating system components. Use this option to run operating system upgrade. If you specify <code>-c</code> , then the only option is <code>os</code> . If you specify <code>-c os</code> , then you can also specify <code>-local</code> (optional).
<code>--node, -n</code>	(Optional) Runs patch pre-checks on specified nodes.
<code>--repo, -r</code>	(Optional) Specify this option to run the patch pre-checks for the repository components.
<code>--server, -s</code>	(Optional) Specify this option to run the patch pre-checks for the server components.
<code>--storage, -st</code>	(Optional) Specify this option to run the patch pre-checks for the storage components.
<code>--version, -v</code>	(Optional) Specifies the version for running the pre-checks.
<code>--skip-orachk, -sko</code>	(Optional) Specifies whether you want to skip ORAchK validations.

Usage Notes

Use the `odacli create-prepatchreport` command to generate a pre-check report. Use the `--node` or `--local` option to run the patch pre-checks on specific nodes or the local node.

Example 14-20 Creating Pre-Check Report

```
# odacli create-prepatchreport -v 19.10.0.0.0 -s

Job details
-----
                ID: e07993d5-0a06-44e7-819a-36d708c52bb6
      Description: Patch pre-checks for [OS, ILOM, GI,
ORACHKSERVER]
                Status: Created
                Created: April 20, 2020 1:01:59 AM PDT
                Message: Use 'odacli describe-prepatchreport -i
e07993d5-0a06-44e7-819a-36d708c52bb6' to check details of results

Task Name Start Time End Time Status
-----
-----
```

odacli delete-agentconfig-parameters

Use the `odacli delete-agentconfig-parameters` command to delete configuration variables used by the appliance.

File Path

```
/opt/oracle/dcs/bin/odacli
```

Syntax

```
odacli delete-agentconfig-parameters
```

Parameters

Parameter	Description
<code>--help, -h</code>	(Optional) Displays help for using the command.
<code>--json, -j</code>	(Optional) Displays JSON output. The default is false.
<code>--name, -n</code>	Specifies the name of the parameter.
<code>--type, -t</code>	(Optional) Deletes the configuration value for the given type. The default value is PUBLIC.

Usage Notes

Use the `odacli delete-agentconfig-parameters` command to delete configuration values. For High-Availability models, the command deletes the parameter values on both nodes in the cluster.

Example 14-21 Deleting configuration parameters

```
# odacli delete-agentconfig-parameters -n HttpProxyHost

Job details
-----
                ID: c6e123c6-1b76-48f8-973d-63c8dab65545
Description:    delete configuration parameter HttpProxyHost
                Status: Running
                Created: January 8, 2021 9:45:39 AM PDT
                Message:

Task Name                Start
Time                    End Time
Status
-----
-----
-----
```

odacli delete-prepatchreport

Use the `odacli delete-prepatchreport` command to delete any pre-check report.

File Path

```
/opt/oracle/dcs/bin/odacli
```

Syntax

```
odacli delete-prepatchreport -i Report ID
```

Parameters

Parameter	Description
<i>Report ID</i>	Describes the ID of the report to be deleted.
<code>--help, -h</code>	(Optional) Displays help for using the command.

Usage Notes

Use the `odacli delete-prepatchreport` command to delete pre-check reports.

Example 14-22 Deleting A Patch Pre-Checks Report

```
# odacli delete-prepatchreport -i 741f635b-7c75-4832-8813-782367f1e6fd
```

odacli describe-component

Use the `odacli describe-component` command to display the installed version and the latest available version for each component.

If there are multiple DB Homes installed in Oracle Database Appliance, then the output displays the version details for each of the installed homes. You can use this command to check the component version after applying a patch.

File Path

`/opt/oracle/dcs/bin/odacli`

Syntax

```
odacli describe-component [-d][-j][-h][-s][-v][-l][-n]
```

Parameters

Parameter	Description
<code>--dbhomes, -d</code>	(Optional) Lists the database home versions and available versions.
<code>--help, -h</code>	(Optional) Displays help for using the command.
<code>--json, -j</code>	(Optional) Displays JSON output. The default is false.
<code>--local, -l</code>	(Optional) Describes the components for the local node. Use to display details on the local node of multi-node high availability (HA) systems. This option is not needed to display component details on single-node systems.
<code>--node, -n</code>	(Optional) Describes the components for a specific node on high availability (HA) systems. This option is not needed to display component details on single node systems. {0 1}
<code>--server, -s</code>	(Optional) Lists the server components and versions and the available versions to which you can patch them.
<code>--systemversion, -v</code>	(Optional) Displays only the system version. This option is available only on high-availability systems.

Usage Notes

Use the `odacli describe-component` command to get component details. On a multi-node environment, the command provides details across all nodes. Use the `--node` or `--local` option to get component details for a specific node.

Example 14-23 Displaying Patch Details for Components for High-Availability Oracle Database Appliance Systems for a Release

```
# /opt/oracle/dcs/bin/odacli describe-component -v
System Version
-----
18.8.0.0.0

System node Name
-----
```



```

node1

Local System Version
-----
18.8.0.0.0

Component                               Installed Version   Available
Version
-----
OAK                                       18.8.0.0.0         up-to-
date

GI                                       18.8.0.0.191015   up-to-
date

DB                                       18.8.0.0.191015   up-to-
date

DCSAGENT                                 18.8.0.0.0         up-to-
date

ILOM                                      4.0.4.41.r130359   up-to-
date

BIOS                                     25080100           up-to-
date

OS                                       6.10               up-to-
date

FIRMWARECONTROLLER                     11.05.03.00        up-to-
date

FIRMWAREEXPANDER                         0018                001e

FIRMWAREDISK {
[ c0d0,c0d1 ]                             A7E0                up-to-
date
[ c1d0,c1d1,c1d2,c1d3,c1d4,c1d5,c1d6,     A72A                a7e0
c1d7,c1d8,c1d9,c1d10,c1d11,c1d12,c1d13,
c1d14,c1d15,c1d16,c1d17,c1d18,c1d19,
c2d0,c2d1,c2d2,c2d3,c2d4,c2d5,c2d6,c2d7,
c2d8,c2d9,c2d10,c2d11,c2d12,c2d13,c2d14,
c2d15,c2d16,c2d17,c2d18,c2d19 ]
[ c1d20,c1d21,c1d22,c2d20,c2d21,c2d22 ]   944A                up-to-
date
}

System node Name
-----
node2

Local System Version
-----

```

18.8.0.0.0

Component Version	Installed Version	Available
OAK date	18.8.0.0.0	up-to-
GI date	18.8.0.0.191015	up-to-
DB date	18.8.0.0.191015	up-to-
DCSAGENT date	18.8.0.0.0	up-to-
ILOM 4.0.4.41.r130359	4.0.2.27.b.r125869	
BIOS	25060400	25080100
OS date	6.10	up-to-
FIRMWARECONTROLLER date	11.05.03.00	up-to-
FIRMWAREEXPANDER	0018	001e
FIRMWAREDISK { [c0d0,c0d1] date	A7E0	up-to-
[c1d0,c1d1,c1d2,c1d3,c1d4,c1d5,c1d6, c1d7,c1d8,c1d9,c1d10,c1d11,c1d12,c1d13, c1d14,c1d15,c1d16,c1d17,c1d18,c1d19, c2d0,c2d1,c2d2,c2d3,c2d4,c2d5,c2d6,c2d7, c2d8,c2d9,c2d10,c2d11,c2d12,c2d13,c2d14, c2d15,c2d16,c2d17,c2d18,c2d19]	A72A	a7e0
[c1d20,c1d21,c1d22,c2d20,c2d21,c2d22] date	944A	up-to-
}		

Example 14-24 List DB Home Details

```
# odacli describe-component -d
```

```
System Version
-----
18.7.0.0.0

System node Name
-----
```

```
node1

Local System Version
-----
18.7.0.0.0

Component                               Installed Version   Available
Version
-----
DB                                         12.2.0.1.190716   up-to-
date
```

```
System node Name
-----
node2
```

```
Local System Version
-----
18.7.0.0.0

Component                               Installed Version   Available
Version
-----
DB                                         12.2.0.1.190716   up-to-
date
```

Example 14-25 List the Server Components and Versions

```
# odacli describe-component -s
System Version
-----
18.7.0.0.0

System node Name
-----
node1

Local System Version
-----
18.7.0.0.0

Component                               Installed Version   Available
Version
-----
OAK                                         18.7.0.0.0         up-to-
date

GI                                         18.7.0.0.190716   up-to-
date

ILOM                                       4.0.4.38.r130206   up-to-
```

```

date

BIOS                               52010400          up-to-
date

OS                                  6.10              up-to-
date

System node Name
-----
node2

Local System Version
-----
18.7.0.0.0

Component                           Installed Version  Available
Version
-----
OAK                                   18.7.0.0.0        up-to-
date

GI                                    18.7.0.0.190716   up-to-
date

ILOM                                  4.0.4.38.r130206  up-to-
date

BIOS                                   52010400          up-to-
date

OS                                    6.10              up-to-
date

```

odacli describe-latestpatch

Use the `odacli describe-latestpatch` command to display a list of the latest supported patch versions for each component.

File Path

```
$ORACLE_HOME/opt/oracle/dcs/bin/odacli
```

Syntax

```
odacli describe-latestpatch [-h]
```

Parameters

Parameter	Description
--help, -h	(Optional) Displays help for using the command.

Parameter	Description
--json, -j	(Optional) Displays JSON output. The default is false.

Example 14-26 Listing the Latest Supported Versions

```
# odacli describe-latestpatch

componentType  availableVersion
-----
gi              18.7.0.0.190716
db              18.7.0.0.190716
db              12.2.0.1.190716
db              12.1.0.2.190716
db              11.2.0.4.190716
oak             18.7.0.0.0
asr             18.3.1
ilom            3.0.16.22.f.r100119
ilom            4.0.2.31.r126282
ilom            4.0.4.41.r130359
ilom            4.0.4.37.r130617
ilom            4.0.0.24.r121140
ilom            4.0.4.40.r130348
ilom            4.0.4.38.r130206
os              6.10
bios            17140300
bios            30150300
bios            25080100
bios            41060300
bios            38130200
bios            39090000
bios            52010400
firmwareexpander 0342
firmwareexpander 001e
firmwareexpander 0306
firmwaredisk    a901
firmwaredisk    0r3q
firmwaredisk    a29a
firmwarecontroller 11.05.03.00
firmwarecontroller qdv1rf30
firmwarecontroller vdv1ry03
firmwarecontroller 20.08.01.14
firmwarecontroller 2.11.1280
firmwarecontroller 13.00.00.00
firmwarecontroller 4.650.00-7176
firmwarecontroller kpyair3q
dcsagent        18.7.0.0.0
firmwaredisk    a7e0
firmwaredisk    a4c0
firmwaredisk    a72a
firmwaredisk    a880
firmwaredisk    a122
firmwaredisk    a38k
firmwaredisk    c122
```

```

firmwaredisk 944a
firmwaredisk 9440
firmwaredisk e12b
firmwaredisk 5g08
firmwaredisk a902
firmwaredisk a140
firmwaredisk sa03
firmwaredisk 0b25
firmwaredisk sf04
firmwaredisk c38k
firmwaredisk a3a0
firmwaredisk pd51
firmwaredisk m554
firmwaredisk 0121
firmwaredisk xc311102

```

odacli describe-prepatchreport

Use the `odacli describe-prepatchreport` command to display the pre-check report, with a list of pre-checks run with status and comments.

Patching pre-checks help identify and remedy any problems before attempting to patch, and ensure all components are ready for updates.

File Path

```
$ORACLE_HOME/opt/oracle/dcs/bin/odacli
```

Syntax

```
odacli describe-prepatchreport -i
```

Parameters

Parameter	Description
<code>--help, -h</code>	(Optional) Displays help for using the command.
<code>--json, -j</code>	(Optional) Displays JSON output. The default is false.
<code>--jobid, -i</code>	Specifies the Job ID for the pre-check report.

Usage Notes

Use the `odacli describe-prepatchreport` command to display the pre-check report.

Example 14-27 Displaying the Patch Pre-Checks Report

```

# odacli describe-prepatchreport -i e07993d5-0a06-44e7-819a-36d708c52bb6

Patch pre-check report
-----
                Job ID:  e07993d5-0a06-44e7-819a-36d708c52bb6
Description:  Patch pre-checks for [OS, ILOM, GI,

```

```
ORACHKSERVER]
      Status: FAILED
      Created: April 20, 2020 1:01:59 AM PDT
      Result: One or more pre-checks failed for [OS, ORACHK]
```

Node Name

node1

Pre-Check Comments	Status	

__OS__		
Validate supported versions	Success	Validated minimum supported versions.
Validate patching tag 19.6.0.0.0.	Success	Validated patching tag:
Is patch location available	Success	Patch location is available.
Validate if ODABR is installed on installed on	Failed	ODABR utility is not installed on
node:		
scaoda8m004.		
Space checks for OS upgrade checks.	Success	Validated space
Install OS upgrade software into	Success	Extracted OS upgrade patches
remove this		/root/oda-upgrade. Do not
completes.		directory untill OS upgrade
Verify OS upgrade by running in:	Success	Results stored
preupgrade checks results/		'/root/preupgrade-
preupg_results-200420010731.tar.gz' .		Read complete report
file		'/root/preupgrade/
result.html' before		attempting OS
upgrade.		
Validate custom rpms installed on installed on	Success	No additional RPMs found
node:scaoda8m004.		
Scheduled jobs check Disable	Failed	Scheduled jobs found.
attempting OS		scheduled jobs before
		upgrade.
__ILOM__		
Validate supported versions	Success	Validated minimum supported

```

versions.
Validate patching tag          Success  Validated patching tag:
19.6.0.0.0.
Is patch location available   Success  Patch location is
available.
Checking Ilom patch Version   Success  Successfully verified the
versions
Patch location validation     Success  Successfully validated
location

__GI__
Validate supported GI versions Success  Validated minimum supported
versions.
Validate available space      Success  Validated free space
under /u01
Verify DB Home versions       Success  Verified DB Home
versions
Validate patching locks       Success  Validated patching
locks
Validate clones location exist Success  Validated clones
location
Validate ODABR snapshots exist Success  No ODABR snaps found on the
node.

__ORACHK__
Running orachk                Failed   Orachk validation
failed: .
Verify diagsnap configuration Failed   diagsnap or pstack are
configured to
collect first failure
diagnostic
Software home                 Failed   Software home check
failed

```

Example 14-28 Example of a Successful Patch Pre-Checks Report

```

# odacli describe-prepatchreport -i aec9373c-96aa-43ce-9aae-8091ec9cd4eb
Patch pre-check report
-----
                Job ID: aec9373c-96aa-43ce-9aae-8091ec9cd4eb
        Description: Pre-Check report for patching [DB]
                Status: COMPLETED
                Result: All pre-checks succeeded

Node Name
-----
node1
Pre-Check          Status
Comments
-----
-----

__DB__
Validate patching tag          Success  Validated patching tag:
12.2.1.2.0

```

Validate available space required	Success	Validated free space
under /u01		
Is system provisioned	Success	Verified system is provisioned
Is patch location available	Success	Patch location is available
Validate minimum agent version	Success	Validated minimum agent version
Verify DBHome patch tag	Success	Verified DB Home patch tag
Is GI upgraded	Success	Validated GI is upgraded
Patch location validation	Success	Successfully validated location
Patch verification on DB	Success	Patch 26710464 not applied on DB
home		
Is patch rollback required	Success	No DB patch is required to rollback
Opatch updation	Success	Successfully updated the opatch in
DbHome		
Patch conflict check	Success	No patch conflicts found on DBHome

odacli list-agentconfig-parameters

Use the `odacli list-agentconfig-parameters` command to list configuration variables used by the appliance.

File Path

`/opt/oracle/dcs/bin/odacli`

Syntax

`odacli list-agentconfig-parameters [-h] [-j] [-n] [-t]`

Parameters

Parameter	Description
<code>--help, -h</code>	(Optional) Displays help for using the command.
<code>--json, -j</code>	(Optional) Displays JSON output. The default is false.
<code>--name, -n</code>	Specifies the name of the parameter.

Parameter	Description
<code>--type, -t</code>	(Optional) Specifies the configuration value for the given type. The default value is PUBLIC.

Usage Notes

Use the `odacli list-agentconfig-parameters` command to list configuration variables used by the appliance.

Example 14-29 Displaying the HttpProxyPort

```
./odacli list-agentconfig-parameters -n HttpProxyPort
```

```
Name      Value      Description
Updated
-----
HttpProxyPort  Http proxy server port  January 8, 2021 4:14:10 AM
UTC
```

Example 14-30 Displaying the agent configuration

```
# odacli list-agentconfig-parameters
```

```
Name      Value      Description
Updated
-----
HttpProxyHost  Http proxy server host  January 8, 2021 4:14:10 AM
UTC
HttpProxyPort  Http proxy server port  January 8, 2021 4:14:10 AM
UTC
HttpsProxyHost  Https proxy server host  January 8, 2021 4:14:10 AM
UTC
HttpsProxyPort  Https proxy server port  January 8, 2021 4:14:10 AM
UTC
```

Related Topics

- [Configuring Agent Proxy Settings for Object Store Access](#)
If the Object Store IP address is accessible only through proxy setup by the Oracle Database Appliance server, then define the proxy setting for the agent, so that the agent can access the Object Store.

odacli list-availablepatches

Use the `odacli list-availablepatches` command to display all available patches for Oracle Database Appliance.

File Path`$(ORACLE_HOME)/opt/oracle/dcs/bin/odacli`**Syntax**`odacli list-availablepatches [-h] [-j]`**Parameters**

Parameter	Description
<code>--help, -h</code>	(Optional) Displays help for using the command.
<code>--json, -j</code>	(Optional) Displays JSON output. The default is false.

Usage Notes

Use the `odacli list-availablepatches` command to display all available patches for Oracle Database Appliance.

Example 14-31 Displaying All Patch Pre-Checks Reports

```
# odacli list-availablepatches
latest Patch Version
-----
18.3.0.0.0

Available Patches   Db Version
-----
18.3.0.0.0         12.2.0.1.180717, 12.1.0.2.180717, 11.2.0.4.180717
```

odacli list-prepatchreports

Use the `odacli list-prepatchreports` command to display all pre-check reports, with a list of pre-checks run with status and comments.

Patching pre-checks help identify and remedy any problems before attempting to patch, and ensure all components are ready for updates.

File Path`/opt/oracle/dcs/bin/odacli`**Syntax**`odacli list-prepatchreports [-h] [-j]`**Parameters**

Parameter	Description
<code>--help, -h</code>	(Optional) Displays help for using the command.

Parameter	Description
--json, -j	(Optional) Displays JSON output. The default is false.

Usage Notes

Use the `odacli list-prepatchreports` command to display all pre-check reports.

Example 14-32 Displaying All Patch Pre-Checks Reports

```
# odacli list-prepatchreports
ID      Description      Created              Status
-----
8a8a14b5-1b5e-4eeb-8ba9-c8136fb4eea1      Patch pre-checks for [DB]:
DbHome is OraDB12102_home1
May 16, 2018 7:00:56 PM PDT                Running
2c9a747d-a452-4e48-bcab-9c7cd9f5f35b      Patch pre-checks for
[STORAGE]
May 16, 2018 6:53:23 PM PDT                Success
f3b9c7c1-3061-4577-848d-645669d71f72      Patch pre-checks for [OS,
ILOM, GI]
May 16, 2018 7:00:56 PM PDT                Running
```

odacli update-agentconfig-parameters

Use the `odacli update-agentconfig-parameters` command to modify configuration variables used by the appliance.

File Path

`/opt/oracle/dcs/bin/odacli`

Syntax

`odacli update-agentconfig-parameters`

Parameters

Parameter	Description
--help, -h	(Optional) Displays help for using the command.
--append, -a	(Optional) Appends the parameter values. For example, <code>-n p1 -v v1 -n p2 -v v2 -a</code> .
--comment, -c	(Optional) Specifies the comment for the parameter.

Parameter	Description
<code>--description, -d</code>	(Optional) Specifies the description of the parameter.
<code>--json, -j</code>	(Optional) Displays JSON output. The default is false.
<code>--name, -n</code>	Specifies the name of the parameter. Provide multiple parameter values in the format <code>-n p1 -v v1 -n p2 -v v2</code> .
<code>--reset, -r</code>	Resets the parameter to the default value. For example: <code>-n p1 -n p2 -r</code> .
<code>--update, -u</code>	Replaces the parameter with the specified value. For example: <code>-n p1 -v v1 -n p2 -v v2 -u</code> .
<code>--value, -v</code>	Specifies the value of the parameter. Provide multiple parameter values in the format <code>-n p1 -v v1 -n p2 -v v2</code> .
<code>--type, -t</code>	(Optional) Specifies the type of the parameter. The default is PUBLIC.

Usage Notes

Use the `odacli update-agentconfig-parameters` command to modify configuration variables used by the appliance. The supported configuration parameters are `HttpsProxyHost` and `HttpsProxyPort`.

Multiple values can be specified. For High-Availability models, the command sets the parameter values on both nodes in the cluster.

Example 14-33 Setting Multiple Parameters

```
# odacli update-agentconfig-parameters -n HttpsProxyPort -v 80 -d "Http
proxy port"
-n HttpsProxyPort -v 80 -d "Https proxy port" -u

update-agentconfig-parameters -n HttpsProxyPort -n HttpProxyPort -r

update-agentconfig-parameters -n HttpsProxyHost -v 90 -a

update-agentconfig-parameters -n OSPatchRepos -v
```

Related Topics

- [Configuring Agent Proxy Settings for Object Store Access](#)
If the Object Store IP address is accessible only through proxy setup by the Oracle Database Appliance server, then define the proxy setting for the agent, so that the agent can access the Object Store.

odacli update-dbhome

Use the `odacli update-dbhome` command to update a specific RDBMS Home to the latest patch bundle version.

File Path

```
/opt/oracle/dcs/bin/odacli
```

Syntax

```
odacli update-dbhome -i dbhomeid -v version [-j] [-h] [-v]
```

Parameters

Parameter	Description
<code>--dbhomeid, -i</code>	Defines the Oracle Database Home to update.
<code>--help-h</code>	(Optional) Displays help for using the command.
<code>--json, -j</code>	(Optional) Displays JSON output. The default is false.
<code>--precheck, -p</code>	Analyzes the patch.
<code>--version, -v</code>	Defines the Oracle Database Appliance version to update. For example, 12.2.1.1.

Usage Notes

- The `update-dbhome` command applies the latest release update (RU) for Oracle Database home.
- To be updated with the latest patches, the database must be running.
- Only databases in the `Configured` status are updated. Use the `odacli list-database` command to see a list of configured databases. Databases in any other status are skipped during the update.

Example 14-34 Updating an Oracle Database Home

To apply the latest patch bundle to update an Oracle Database:

```
# odacli update-dbhome -i ad6c7326-e460-411e-94df-230dedbef743 -v
19.10.0.0.0
```

odacli update-dcsadmin

Use the `odacli update-dcsadmin` command to update the DCS admin components for Zookeeper upgrade.

File Path

```
$ORACLE_HOME/opt/oracle/dcs/bin/odacli
```

Syntax

```
odacli update-dcsadmin -v version [-j] [-h]
```

Parameters

Parameter	Description
--version, -v	Defines the Oracle Database Appliance version after update.
--help, -h	(Optional) Displays help for using the command.
--json, -j	(Optional) Displays JSON output.

Usage Notes

The `update-dcsadmin` command sets up the `dcsadmin` and other components. Run the `update-dcsadmin` command only after you update the DCS agent.

Example 14-35 Updating DCS Admin

```
# odacli update-dcsadmin -v 18.7.0.0.0
{
  "jobId" : "4c238b93-e641-4f9d-9f86-93d0574dd234",
  "status" : "Created",
  "message" : null,
  "reports" : [ ],
  "createTimestamp" : "July 12, 2019 03:11:53 AM UTC",
  "resourceList" : [ ],
  "description" : "DcsAdmin patching",
  "updatedAtTime" : "July 12, 2019 03:11:53 AM UTC"
}
```

odacli update-dcsagent

Use the `odacli update-dcsagent` command to update the agent.

File Path

```
$ORACLE_HOME/opt/oracle/dcs/bin/odacli
```

Syntax

```
odacli update-dcsagent -v version [-j] [-h]
```

Parameters

Parameter	Description
--version, -v	Defines the Oracle Database Appliance version after update.
--help, -h	(Optional) Displays help for using the command.

Parameter	Description
--json, -j	(Optional) Displays JSON output.

Usage Notes

The `update dcsagent` command updates the `dcs-agent` to the RPM package that is located in the `location` and restarts the `dcs-agent`. After the update is applied, the agent automatically restarts. It will take a few minutes to reconnect to the `dcs-agent`. Wait until the agent shuts down and completes restarting before performing any tasks.

Note:

Before updating the agent, ensure that you do not have any jobs running or pending during the update window.

Example 14-36 Updating the Agent

To update the `dcs-agent` to version 19.10:

```
# odacli update-dcsagent -v 19.10
{
  "jobId" : "77e454d3-eb68-4130-a247-7633f8d6192b",
  "status" : "Created",
  "message" : null,
  "reports" : [ ],
  "createTimestamp" : "January 8, 2021 14:09:24 PM CST",
  "description" : "DcsAgent patching",
  "updatedAtTime" : "January 8, 2021 14:09:24 PM CST"
}
```

odacli update-dcscomponents

Use the `odacli update-dcscomponents` command to update the DCS components such as the DCS agent and Zookeeper.

File Path

```
$ORACLE_HOME/opt/oracle/dcs/bin/odacli
```

Syntax

```
odacli update-dcscomponents -v version [-j] [-h]
```

Parameters

Parameter	Description
--version, -v	Defines the Oracle Database Appliance version after update.

Parameter	Description
--help, -h	(Optional) Displays help for using the command.
--json, -j	(Optional) Displays JSON output.

Usage Notes

The `update-dcscomponents` command sets up the `dcscomponents` such as Zookeeper.

Example 14-37 Updating DCS Components

```
# odacli update-dcscomponents -v 18.7.0.0.0
{
  "jobId" : "4c238b93-e641-4f9d-9f86-93d0574dd234",
  "status" : "Created",
  "message" : null,
  "reports" : [ ],
  "createTimestamp" : "July 12, 2019 03:11:53 AM UTC",
  "resourceList" : [ ],
  "description" : "DcsComponents patching",
  "updatedAtTime" : "July 12, 2019 03:11:53 AM UTC"
}
```

odacli update-registry

Use the `odacli update-registry` command to update the registry of components when you apply patches manually.

File Path

`$ORACLE_HOME/opt/oracle/dcs/bin/odacli`

Syntax

```
odacli update-registry -n component [-f] [-j] [-h]
```

Parameters

Parameter	Description
--component, -n	Defines the Oracle Database Appliance component for the registry update. The values can be <code>system {gihome, dbnode, sysinstance}</code> or <code>all {dbhome, db, dbstorage, asr}</code> . You can also specify the individual component to be refreshed. Note: Refresh system components before you refresh all components.
-f	(Optional) Forces the refresh of the specified component even if it already exists in the appliance registry metadata.
--help, -h	(Optional) Displays help for using the command.

Parameter	Description
--json, -j	(Optional) Displays JSON output.

Usage Notes

The `update-registry` command updates the registry of components when you apply patches manually.

The `update-registry` command rediscovers only the following DCS components resources:

- System resources : Oracle Grid Infrastructure (gihome), Oracle Database node (dbnode), System instance (sysinstance)
- Database Home (dbhome)
- Database (db)
- Database storage (dbstorage)
- Oracle ASR

The `update-registry` command does not rediscover any other components not mentioned in the list.

Example 14-38 Updating the Registry with the -force option

```
# odacli update-registry -n system
DCS-10112:Specified components are already discovered.
```

Using force flag option to rediscover and update the system components though it already exists in appliance registry

```
# odacli update-registry -n system -f
```

Job details

```
-----
ID: 752b56d8-2bcd-4a29-ab96-196925fc5c13
Description: Discover System Components : system
Status: Created
Created: July 31, 2019 1:02:51 PM UTC
Message:
```

```
Task Name Start Time End Time Status
-----
```

```
# odacli describe-job -i 752b56d8-2bcd-4a29-ab96-196925fc5c13
```

Job details

```
-----
ID: 752b56d8-2bcd-4a29-ab96-196925fc5c13
Description: Discover System Components : system
Status: Success
Created: July 31, 2019 1:02:51 PM UTC
Message:
```

```

Task Name Start Time End Time Status
-----
-----
Rediscover SysInstance July 31, 2019 1:02:51 PM UTC July 31, 2019
1:03:24 PM UTC Success
Rediscover DBNode July 31, 2019 1:03:24 PM UTC July 31, 2019 1:03:24 PM
UTC Success
Rediscover GiHome July 31, 2019 1:03:24 PM UTC July 31, 2019 1:03:26 PM
UTC Success

```

odacli update-repository

Use the `odacli update-repository` command to update the repository with the new Oracle Database Appliance software.

Prerequisites

Before updating the repository, you must upload the Oracle Database Appliance software to the appliance. If the patch contains more than one zip file, then extract and concatenate the zip files before updating the repository.

File Path

```
/opt/oracle/dcs/bin/odacli
```

Syntax

To unpack and copy the patch bundle to the correct locations in the file system:

```
odacli update-repository -f filename [-j] [-h]
```

Parameters

Parameter	Description
<code>--filename, -f</code>	Defines the zip filename of patch bundle or RDBMS clones downloaded from My Oracle Support. Provide a comma-separated list of absolute file paths of the end user and patch bundles.
<code>--json, -j</code>	(Optional) Displays JSON output. The default is false.
<code>--help, -h</code>	(Optional) Displays help for using the command.

Usage Notes

- Before updating the repository, ensure that you do not have any jobs running or pending during the update window.
- Upload the patches to `dom0` on `Node0`. On multi-node systems, the DCS-Agent copies the patch to `Node1` and updates the patch repository on both nodes.

Example 14-39 Updating the Repository

The server patch zip file is located in the `/u01/tmpdir` directory. The following example updates the repository with the latest server patch and then lists the job to verify that the update is successful:

```
# /opt/oracle/dcs/bin/odacli update-repository -f /tmp/
oda-sm-19.10.0.0.0-210216-server1of2.zip,/tmp/oda-sm-19.10.0.0.0-210216-
server2of2.zip
{
  "jobId" : "d3510276-da05-447b-990e-6d30964f8f79",
  "status" : "Created",
  "message" : "/u01/tmpdir/oda-sm-12.2.1.1.0-171031-server.zip",
  "reports" : [ ],
  "createTimestamp" : "January 8, 2021 14:13:45 AM CST",
  "description" : "Repository Update",
  "updatedAtTime" : "January 8, 2021 14:13:45 AM CST"
}
[root@oak1 tmpdir]# ./odacli list-jobs
# odacli list-jobs
ID                                     Description
Created                               Status
-----
6f27a29a-959f-44e1-b984-7473e3c918ad  Server Patching   January 8, 2021
14:19:05 AM CST      Success
```

odacli update-server

Use the `odacli update-server` command to update the operating system, firmware, Oracle Appliance Kit, Oracle Clusterware, and all other infrastructure components.

File Path

```
/opt/oracle/dcs/bin/odacli
```

Syntax

```
odacli update-server [-p] [-l] -v version [-j] [-h]
```

Parameters

Parameter	Description
<code>--precheck, -p</code>	(Optional) Analyzes the patch.
<code>--version, -v</code>	Defines the version to update.
<code>--local, -l</code>	(Optional) Updates the server on the local node of multi-node high availability (HA) systems. This option is not needed for single-node systems.
<code>--json, -j</code>	(Optional) Displays JSON output. The default is false.
<code>--help, -h</code>	(Optional) Displays help for using the command.

Usage Notes

The `update-server` command applies the patches to various infrastructure components and Oracle Clusterware.

After the update is applied, the agent automatically restarts. It will take a few minutes to reconnect to the server. Wait until the agent shuts down and completes restarting before performing any tasks. Allow at least two (2) minutes before running the next command.



Note:

Before updating the server, ensure that you do not have any jobs running or pending during the update window.

Example 14-40 Updating the Server

Run the `odacli update-server` command to update the server to 19.10.0.0.0. On a multi-node HA system, you must run the command on both nodes to update the server version.

```
# odacli update-server -v 19.10.0.0.0
{
  "jobId" : "6f27a29a-959f-44e1-b984-7473e3c918ad",
  "status" : "Created",
  "message" : "Success of Server Update may trigger reboot of node
after 4-5 minutes.
Please wait till node restart",
  "reports" : [ ],
  "createTimestamp" : "January 8, 2021 14:13:45 PM CST",
  "resourceList" : [ ],
  "description" : "Server Patching",
  "updatedAt" : "January 8, 2021 14:13:45 PM CST"
}
```

odacli update-storage

Use the `odacli update-storage` command to update the storage.

File Path

```
/opt/oracle/dcs/bin/odacli
```

Syntax

```
odacli update-storage -v version [-h] [-j] [-r]
```

Parameters

Parameter	Description
--version, -v	Defines the version to update.
--json, -j	(Optional) Displays JSON output. The default is false.
--help, -h	(Optional) Displays help for using the command.
--rolling, -r	(Optional) Enables to patch shared disks in rolling fashion without stopping Oracle Clusterware. The shared disks must be online.

Usage Notes

- If the FIRMWAREEXPANDER Installed Version is lower than or equal to the Available Version, then you cannot use rolling mode to update the storage.

Example 14-41 Updating the Storage

```
# odacli update-storage -v 19.10.0.0.0
```

odaadmcli orachk

Use the `odaadmcli orachk` command to check configuration settings for Oracle Database Appliance components.

File Path

```
/opt/oracle/dcs/bin/odaadmcli
```

Syntax

To perform diagnostic checks of components:

```
odaadmcli orachk [-h]
```

Parameters

Parameter	Description
--help, -h	(Optional) Displays help for using the command.
Components such as -a, -acchk, -applypatch, -autostop	(Optional) Specifies the comma-separated list of components for which you want to collect data. Specify the component to be checked in the command. For example: # odaadmcli orachk -a
--verbose	Displays detailed message.

Usage Notes

The `odaadmcli orachk` command invokes `orachk` from the directory `opt/oracle.SupportTools/orachk`.

Example 14-42 Running `odaadmcli orachk`

```
[root@oak bin] # ./odaadmcli orachk
INFO: 2019-09-04 16:41:26: Running orachk under /opt/
oracle.SupportTools/orachk
```

Example 14-43 Running `odaadmcli orachk` for a component

```
[root@oak bin] # ./odaadmcli orachk -a
INFO: 2019-09-19 10:45:16: Running orachk under /usr/bin/orachk
Checking ssh user equivalency settings on all nodes in cluster for root
```

odacli Appliance Commands

Use the `odacli` appliance commands to perform lifecycle activities for the appliance.

- [odacli set-credential](#)
Use the `odacli set-credential` command to change the `oda-admin` user credentials.
- [odacli create-appliance](#)
Use the `odacli create-appliance` command in a JSON file format to provision Oracle Database Appliance.
- [odacli describe-system](#)
Use the `odacli describe-system` command to display details about components installed on the system.
- [odacli list-featuretracking](#)
Use the `odacli list-featuretracking` command to display the latest feature tracking report.

odacli set-credential

Use the `odacli set-credential` command to change the `oda-admin` user credentials.

Syntax

To reset the `oda-admin` user credentials in interactive mode:

```
odacli set-credential --username username [-j] [-h]
```

Parameters

Parameter	Description
--username, -u	User name required to access the Oracle Appliance Manager Browser User Interface. The default user name is <code>oda-admin</code> .
--json, -j	(Optional) Displays JSON output.
--help, -h	(Optional) Displays help for using the command.

Usage Notes

Only `root` user can reset the `oda-admin` user credentials.

Example 14-44 Resetting the `oda-admin` Password in Interactive Mode

To reset the `oda-admin` user password to a new password in interactive mode:

```
# odacli set-credential --username oda-admin
Enter 'user' password:
Retype 'user' password:
```

odacli create-appliance

Use the `odacli create-appliance` command in a JSON file format to provision Oracle Database Appliance.

File Path

```
$ORACLE_HOME/opt/oracle/dcs/bin/odacli
```

Syntax

To view help for the `odacli create-appliance` command:

```
odacli create-appliance -r requestjson [-j] [-h]
```

Note:

The `odacli create-appliance` command only supports a JavaScript Object Notation (JSON) file format. An example JSON files and a readme are available in an appendix in this document and in the `/opt/oracle/dcs/sample` directory.

Parameters

Parameter	Description
--requestjson, -r	JSON input for appliance creation.
--json, -j	(Optional) Displays JSON output.

Parameter	Description
--help, -h	(Optional) Displays help for using the command.

odacli describe-system

Use the `odacli describe-system` command to display details about components installed on the system.

File Path

`$ORACLE_HOME/opt/oracle/dcs/bin/odacli`

Syntax

To list jobs and view job details and status:

```
odacli describe-system [-h] [-b] [-d] [-j]
```

Parameters

Parameter	Description
--json, -j	(Optional) Displays JSON output.
--help, -h	(Optional) Displays help for using the command.
--bom, -b	(Optional) Displays the bill of materials for the installed components on the appliance.
--details, -d	(Optional) Display on the command-line, the details of all installed components on the appliance.

Usage Notes

Do not provide both options `-b` and `-d` at the same time, in the command.

Example 14-45 Example Command to View the Bill of Materials from the Command Line for Bare Metal Deployments

```
# odacli describe-system -b
ODA Components Information
-----
Component Name          Component
Details
-----
-----
NODE                    Name : odal
                        Domain Name :
                        Time Stamp : April 29, 2020 7:00:12 PM
UTC
```

```
RPMS                               Installed RPMS :
acl-2.2.49-7.el6_9.1.x86_64,
                                   aide-0.14-11.el6.x86_64,
                                   alsa-
lib-1.1.0-4.el6.x86_64,
                                   at-3.1.10-49.el6.x86_64,
                                   atk-1.30.0-1.el6.x86_64,
                                   attr-2.4.44-7.el6.x86_64,
                                   audit-2.4.5-6.el6.x86_64,
                                   audit-
libs-2.4.5-6.el6.x86_64,
                                   audit-libs-
python-2.4.5-6.el6.x86_64,
                                   augeas-
libs-1.0.0-10.el6.x86_64,
                                   avahi-
authconfig-6.1.12-23.el6.x86_64,
                                   b43-
libs-0.6.25-17.el6.x86_64,
                                   bash-4.1.2-48.el6.x86_64,
                                   bc-1.06.95-1.el6.x86_64,
openfwf-5.2-10.el6.noarch,
                                   bind-
basesystem-10.0-4.0.1.el6.noarch,
                                   bind-
                                   bridge-
                                   bzip2-
                                   ca-
                                   clog-
                                   compat-
libs-9.8.2-0.62.rc1.el6_9.5.x86_64,
                                   bash-4.1.2-48.el6.x86_64,
                                   bc-1.06.95-1.el6.x86_64,
                                   bind-
                                   bind-
utils-9.8.2-0.62.rc1.el6_9.5.x86_64,
                                   bridge-
binutils-2.20.51.0.2-5.47.el6_9.1.x86_64,
                                   bzip2-
                                   ca-
biosdevname-0.7.2-1.el6.x86_64,
                                   clog-
                                   compat-
utils-1.2-10.el6.x86_64,
                                   clog-
                                   compat-
busybox-1.15.1-21.el6_6.x86_64,
                                   compat-
bzip2-1.0.5-7.el6_0.x86_64,
                                   compat-
libs-1.0.5-7.el6_0.x86_64,
                                   compat-
certificates-2017.2.14-65.0.1.el6_9.noarch,
                                   compat-
cairo-1.8.8-6.el6_6.x86_64,
                                   compat-
celt051-0.5.1.3-0.el6.x86_64,
                                   compat-
checkpolicy-2.0.22-1.el6.x86_64,
                                   compat-
chkconfig-1.3.49.5-1.el6.x86_64,
                                   compat-
ppl-0.15.7-1.2.el6.x86_64,
                                   compat-
libcap1-1.10-1.x86_64,
```

```
+33-3.2.3-69.el6.x86_64,  
readline5-5.2-17.1.el6.x86_64,  
+4.8.2-16.el6.x86_64,  
ConsoleKit-0.4.1-6.el6.x86_64,  
libs-0.4.1-6.el6.x86_64,  
x11-0.4.1-6.el6.x86_64,  
coreutils-8.4-46.0.1.el6.x86_64,  
libs-8.4-46.0.1.el6.x86_64,  
  
cpupowerutils-1.3-2.el6.x86_64,  
cpuspeed-1.5-22.0.1.el6.x86_64,  
cracklib-2.8.16-4.el6.x86_64,  
dicts-2.8.16-4.el6.x86_64,  
crash-7.1.4-1.0.1.el6_7.x86_64,  
crda-3.13_2015.10.22-3.el6.x86_64,  
createrepo-0.9.9-27.el6_9.noarch,  
cronie-1.4.4-16.el6_8.2.x86_64,  
anacron-1.4.4-16.el6_8.2.x86_64,  
crontabs-1.10-33.el6.noarch,  
luks-1.2.0-11.el6.x86_64,  
libs-1.2.0-11.el6.x86_64,  
libs-1.4.2-78.el6_9.x86_64,  
  
....  
....  
....
```

compat-libstdc+
compat-
compat-sap-c+

ConsoleKit-
ConsoleKit-

coreutils-

cpio-2.10-13.el6.x86_64,
cpp-4.4.7-18.el6.x86_64,

cracklib-

cronie-

cryptsetup-
cryptsetup-luks-
cups-

odacli list-featuretracking

Use the `odacli list-featuretracking` command to display the latest feature tracking report.

File Path

```
$ORACLE_HOME/opt/oracle/dcs/bin/odacli
```

Syntax

Use the `odacli list-featuretracking` command to display the latest feature tracking report.

```
odacli list-featuretracking [-h] [-j]
```

Parameters

Parameter	Description
<code>--json, -j</code>	(Optional) Displays JSON output.
<code>--help, -h</code>	(Optional) Displays help for using the command.

Example 14-46 Example Command to View the Features Report from the Command Line

```
# odacli list-featuretracking
                                     DCS Feature Tracking Report

Last collection date: 10/26/18 15:35
Report version:      1.0

-----
DCS Feature Usage Summary

Detected   Total      Last Usage                               Currently
Feature Name                               Used
Usages Samples      Time

-----
Object Store
TRUE          12      12 10/26/18 15:35
Automatic Service Request (ASR)
FALSE         0       12
Storage Expansion Shelf
FALSE         0       12

-----
DCS High Water Mark Statistics
```

Measured Feature Name	High Water
Mark Category	

Maximum usage of CPU	8.12
% DCS Agent	
Maximum usage of Memory	437.12
MB DCS Agent	
Maximum number of threads	
150 DCS Agent	
Maximum number of open file descriptors	
257 DCS Agent	
Maximum number of Databases	
1 Database	
Maximum number of EE Databases	
1 Database	
Maximum number of SE Databases	
0 Database	
Maximum number of CDBs	
1 Database	
Maximum number of non-CDBs	
0 Database	
Maximum number of RAC Databases	
1 Database	
Maximum number of RAC One Databases	
0 Database	
Maximum number of Single Instance Databases	
0 Database	
Maximum number of PDBs	
0 Database	
Maximum number of Datafiles	
7 Database	
Maximum number of Database Homes	
1 Database	
Maximum number of Flashback Databases	
0 Database	
Maximum size of a Database	6.40
GB Database	
Minimum Database version	
18.0.0.0.0 Database	
Maximum Database version	
18.0.0.0.0 Database	
Maximum number of Backups	
12 Database	
Maximum number of NFS Backups	
0 Database	
Maximum number of Object Store Backups	
12 Database	
Maximum number of Disk Backups	
0 Database	
Maximum number of Regular-L0 Backups	
0 Database	
Maximum number of Regular-L1 Backups	
1 Database	
Maximum number of ArchiveLog Backups	
9 Database	

Maximum number of Longterm Backups	2	Database	
Maximum interval between Database Backups	01:01:06	Database	0 Day(s),
Maximum number of Object Store tenants	1	Object Store	
Maximum number of enabled CPU cores	12	Server	
Maximum number of disks	24	Storage	
Maximum number of ASM Disks Groups	3	Storage	
Maximum size of ASM Disk Groups	TB	Storage	11.46
Maximum usage of ASM Disk Groups	%	Storage	1.70
Maximum number of ASM Disks Groups with redundancy 'NORMAL'	0	Storage	
Maximum number of ASM Disks Groups with redundancy 'HIGH'	3	Storage	
Maximum number of ASM Disks Groups with redundancy 'EXTERN'	0	Storage	
Maximum number of ASM Disks Groups with redundancy 'FLEX'	0	Storage	
Maximum ASM Disk Groups compatibility	18.0.0.0.0	Storage	
Minimum ASM Disk Groups compatibility	18.0.0.0.0	Storage	
Maximum number of non-ACFS file systems	4	Storage	
Maximum size of non-ACFS file systems	GB	Storage	98.31
Maximum usage of non-ACFS file systems	%	Storage	82.71
Maximum number of ACFS file systems	1	Storage	
Maximum size of ACFS file systems	GB	Storage	5.00
Maximum usage of ACFS file systems	%	Storage	12.19

odacli Backup and Recovery Commands

Use the odacli backup and recover commands to backup to and restore from Oracle Cloud Infrastructure Object Storage or disk.

Topics:

- [odacli create-backup](#)
Use the command `odacli create-backup` to create a Level 0, Level 1, archivelog, or Longterm backup.
- [odacli create-backupconfig](#)
Use the command `odacli create-backupconfig` to create a backup configuration.

- [odacli create-objectstoreswift](#)
Use the command `odacli create-objectstoreswift` to create and store the Oracle credential details required to backup to Oracle Object Store.
- [odacli delete-backup](#)
Use the command `odacli delete-backup` to delete backups.
- [odacli delete-backupconfig](#)
Use the command `odacli delete-backupconfig` to delete a backup configuration.
- [odacli describe-backupreport](#)
Use the command `odacli describe-backupreport` to display details of a specific backup report.
- [odacli delete-objectstoreswift](#)
Use the command `odacli delete-objectstoreswift` to delete the credentials for the ObjectStore account.
- [odacli describe-schedule](#)
Use the command `odacli describe-schedule` to display details for a specific schedule.
- [odacli irestore-database](#)
Use the command `odacli irestore-database` to restore a database from one system to other system from an external FRA (NFS) or Object Store location based on a BackupReport.
- [odacli list-backupconfigs](#)
Use the command `odacli list-backupconfigs` to list all backup configurations.
- [odacli list-backupreports](#)
Use the command `odacli list-backupreports` to display a list of all backup reports.
- [odacli list-objectstoreswifts](#)
Use the command `odacli list-objectstoreswifts` to display a list of credentials for the ObjectStore account.
- [odacli list-schedules](#)
Use the command `odacli list-schedules` to display all of the schedules in the system, including database backup schedules and some internal maintenance schedules.
- [odacli list-tdebackupreports](#)
Use the `odacli list-tdebackupreports` command to view TDE Wallet backup reports.
- [odacli recover-database](#)
Use the `odacli recover-database` command to recover or restore a database from backup.
- [odacli restore-archivelog](#)
Use the `odacli restore-archivelog` command to restore archivelog from one SCN to another SCN, or from one timestamp to another timestamp.
- [odacli restore-tdewallet](#)
Use the `odacli restore-tdewallet` command to recover or restore TDE wallet from the backup location.

- [odacli update-backupconfig](#)
Use the command `odacli update-backupconfig` to update a backup configuration.
- [odacli update-objectstoreswift](#)
Use the command `odacli update-objectstoreswift` to change the credentials for the ObjectStore account.
- [odacli update-schedule](#)
Use the command `odacli update-schedule` to update the schedule for a database, or to disable the database backup schedule.

odacli create-backup

Use the command `odacli create-backup` to create a Level 0, Level 1, archive log, or Longterm backup.

File Path

```
/opt/oracle/dcs/bin/odacli
```

Syntax

```
odacli create-backup -i Database Resource ID [-bt] [-c] [-h] [-j]
[-k] [-t]
```

Parameters

Parameter	Description
<code>--backupType, -bt {Regular-L0 Regular-L1 Longterm archive log}</code>	Defines the type of backup. The options are not case sensitive.
<code>--component, -c {Database TDEWallet}</code>	(Optional) Defines the component. The supported options are Database and TDE Wallet. The options are not case-sensitive. The default value is Database. If you specify the value as Database, then a backup of both the database and TDE Wallet is taken.
<code>--dbName, -in</code>	Defines the Database name (required for database components backup).
<code>--dbid, -i</code>	Defines the Database Resource ID (required for database components backup).
<code>--help, -h</code>	(Optional) Displays help for using the command.
<code>--json, -j</code>	(Optional) Displays JSON output. The default is false.
<code>--keep-archive log, -ka</code>	Keeps archive logs.
<code>--keepDays, -k</code>	Defines the Keep Days. For Longterm Backup Type only.
<code>--tag, -t</code>	Defines the name of the backup. A tag is alphanumeric, up to 30 characters. Required for Longterm Backup Type. The tag must be wrapped in single quotes when special characters are used.

Usage Notes

- Use the command `odacli create-backup` for a specified Database Resource ID and provide a tag for the backup name. Use up to 30 alphanumeric characters for the backup name tag. Three types of backups are available:
 - Level 0: An RMAN incremental backup that backs up all data blocks in the data files being backed up. An incremental backup at level 0 is identical in content to a full backup, but unlike a full backup, the level 0 backup is part of an incremental backup strategy.
 - Level 1: An RMAN incremental backup that includes only those blocks that have been changed since the "parent" backup was taken. A parent backup can be either a level 0 or a level 1 backup. If you do not select a backup type (level 0, level 1, or LongTerm), a level 1 backup is performed.
 - Longterm: Longterm backups are only available when backing up to Oracle Cloud Infrastructure Object Storage (Oracle Object Storage).
 - Archivelog: This option is used to perform backup of all archivelogs not yet backed up to the backup destination, such as Internal FRA, External FRA (NFS location), or Object Store.
- This command creates a Backup Report with a Resource ID. To get the ID, use the command `odacli describe-job -i job_id -j` and look for the `resourceId` attribute in `resourceList`.

Example 14-47 Create a Manual Database Backup

Create a long term backup that is kept for 90 days and named q12018HR.

```
# odacli create-backup -i Database Resource ID -bt Longterm -c
database -k 90 -t q12018HR
```

Example 14-48 Create a Level 0 Database Backup

Create a Level 0 backup named 2017Dec22ProductionLevel0 for resource ID 20576eb1-bc32-4e34-bf97-fda0b60ca15b

```
# odacli create-backup -i 20576eb1-bc32-4e34-bf97-fda0b60ca15b -bt
Regular-L0 -t 2017Dec22ProductionLevel0
```

Example 14-49 Create a Backup of only the TDE Wallet

```
# odacli create-backup -n testdb -c TDEWallet
```

Example 14-50 Create a Backup of the database and TDE Wallet

```
# odacli create-backup -n testdb -bt regular-l0
```

odacli create-backupconfig

Use the command `odacli create-backupconfig` to create a backup configuration.

File Path

`/opt/oracle/dcs/bin/odacli`

Syntax

```
odacli create-backupconfig -n backup configuration name -d backup destination{Disk|ObjectStore|NFS|None} [-c] [-cr] [-h] [-j] [-no-cr] [-o] [-w] [-f]
```

Parameters

Parameter	Description
<code>--backupdestination, -d {Disk ObjectStore NFS None}</code>	Defines the backup destination. The options are not case sensitive.
<code>--container, -c</code>	(Optional) Defines the object store container.
<code>--crosscheck, -cr</code>	(Optional) Enable crosscheck.
<code>--help, -h</code>	(Optional) Displays help for using the command.
<code>--json, -j</code>	(Optional) Displays JSON output. The default is false.
<code>--name, -n</code>	Defines the backup configuration name.
<code>--no-crosscheck, -no-cr</code>	(Optional) Disable crosscheck.
<code>--objectstoreswiftId, -o</code>	(Optional) Defines the swift object store credential ID.
<code>--tde-container, -f</code>	(Optional) Defines the container or backup location to backup the TDE Wallet. Must be the absolute path to the parent directory when the backup target is NFS, and must be the container name when the backup target is Objectstore.
<code>--recoverywindow, -wDisk: {1-14} ObjectStore: {1-31}</code>	(Optional) Defines the Recovery Window in days. {1-14} days for Disk and {1-31} days for Object Storage in the cloud.

Usage Notes

- To backup a TDE-enabled database, backup configuration with separate TDE Wallet backup location and Database backup location is mandatory.
- To backup a non-TDE database, backup configuration with either single database backup location or backup configuration with both database backup location and TDE Wallet backup location can be used.
- For Disk backup configuration, TDE Wallet backup location is by default, Fast Recovery Area (FRA), but in a separate path from the Database backup path

within FRA. Hence, TDE Wallet backup location need not be specified when creating the Disk backup configuration.

- The recovery window that is defined in the backup configuration determines when backups are considered obsolete. The following are guidelines:
 - Disk: 1-14 days
 - Object Storage: 1-31 days

Example 14-51 Create a Backup Configuration for disk

Create a backup configuration named `production` that backs up to disk with a 14 day recovery window.

```
# odacli create-backupconfig -d Disk -n production -w 14
```

Example 14-52 Create a Backup Configuration for NFS location

Create a backup configuration that backs up to NFS with a 2 day recovery window.

```
# odacli create-backupconfig -d NFS -n NfsPolicy1 -c /tmp/Nfsbackps -w 2
```

Example 14-53 Create a Backup Configuration with separate backup locations for database backup and TDE Wallet backup

```
# odacli create-backupconfig -n bcfg1 -d Objectstore -w 1 -c location1-  
on oss1 -f location2
```

Example 14-54 Create a Backup Configuration with single backup location for database backup

```
# odacli create-backupconfig -n bcfg2 -d Objectstore -w 1 -c testb2 -on  
oss2
```

odacli create-objectstoreswift

Use the command `odacli create-objectstoreswift` to create and store the Oracle credential details required to backup to Oracle Object Store.

File Path

```
/opt/oracle/dcs/bin/odacli
```

Syntax

```
# odacli create-objectstoreswift -e swift end point URL [-h] [-j] -n  
Object Store Swift name -t Object Store tenant name -u Object Store  
user name
```

Parameters

Parameter	Description
<code>--endpointurl, -e</code>	Defines the swift end point URL.
<code>--help, -h</code>	(Optional) Displays help for using the command.
<code>--json, -j</code>	(Optional) Displays JSON output. The default is false.
<code>--name, -n</code>	Defines the Object Store Swift name.
<code>--tenantname, -t</code>	Defines the Object Store Swift tenant name.
<code>--username, -u</code>	Defines the Object Store Swift user name.

Usage Notes

The command creates and stores the Oracle Cloud Infrastructure Object Storage credential details in the system and stores the password in an encrypted Oracle wallet. You can attach the credentials to one or more backup configurations.

The credentials are validated during the command `odacli create-backupconfig` with `objectstore` as the destination. The credentials are not validated against endpoint URL and tenancy.

odacli delete-backup

Use the command `odacli delete-backup` to delete backups.

File Path

`$ORACLE_HOME/opt/oracle/dcs/bin/odacli`

Syntax

```
odacli delete-backup -iDatabase Resource ID [-br] [-h] [-j]
```

Parameters

Parameter	Description
<code>--backupreport, -br</code>	(Optional) Defines the backup report. To delete a Long Term backup, use a JSON input file for the backupreport.
<code>--dbid, -i</code>	Defines the Database Resource Identifier (ID). To delete a level 0 or level 1 backup, use the database resource ID.
<code>--help, -h</code>	(Optional) Displays help for using the command.
<code>--json, -j</code>	(Optional) Displays JSON output. The default is false.

Usage Notes

- Delete older, obsolete level 0 and level 1 backups with the Database Resource ID. The recovery window that is defined in the backup configuration determines when backups are considered obsolete.
- Delete long term backups from Oracle Object Storage by using a JSON file with the `--backupreport` option.
- To locate the database ID, view the databases in the Browser User Interface or use the command `odacli list-databases`.

Example 14-55 Delete a Level 0 or Level 1 Backup

```
# odacli delete-backup -i20576eb1-bc32-4e34-bf97-fda0b60ca15b
```

Example 14-56 Delete a Long Term Backup Report

Delete a Long Term backup using a JSON input file for the Backup Report. In this example, `backupreport.json` is the JSON input for the `backupreport`.

```
# odacli delete-backup -i 20576eb1-bc32-4e34-bf97-fda0b60ca15b -br
backupreport.json
```

odacli delete-backupconfig

Use the command `odacli delete-backupconfig` to delete a backup configuration.

File Path

```
$ORACLE_HOME/opt/oracle/dcs/bin/odacli
```

Syntax

```
odacli delete-backupconfig -i backup configuration id [-h] [-j]
```

Parameters

Parameter	Description
<code>--help, -h</code>	(Optional) Displays help for using the command.
<code>--id, -i</code>	Defines the Backup Config identifier (ID).
<code>--json, -j</code>	(Optional) Displays JSON output. The default is false.

Usage Notes

You cannot delete a backup configuration if it is attached to a database.

Example 14-57 Deleting a Backup Configuration

Delete a backup configuration named `production` that backs up to disk with a 14 day recovery window.

```
# odacli delete-backupconfig -d Disk -n production -w 14
```

odacli describe-backupreport

Use the command `odacli describe-backupreport` to display details of a specific backup report.

File Path

```
$ORACLE_HOME/opt/oracle/dcs/bin/odacli
```

Syntax

```
odacli describe-backupreport [-h] [-j] [-i]
```

Parameters

Parameter	Description
<code>--help, -h</code>	(Optional) Displays help for using the command.
<code>--json, -j</code>	(Optional) Displays JSON output. The default is false.
<code>--id, -i</code>	Defines the backup report ID.

Example 14-58 Display Details of a Specific Backup Report

```
# odacli describe-backupreport -i 2d82460c-d648-4e75-8c7d-72cc90bc442a
{
  "id" : "2d82460c-d648-4e75-8c7d-72cc90bc442a",
  "dbResId" : "b5fc646e-01a6-4c8b-8286-7633346c4329",
  "tag" : null,
  "dbId" : "2717054291",
  "dbName" : "ExampleDB",
  "dbUniqueName" : "ExampleDBu",
  "backupType" : "REGULAR-L1",
  "keepDays" : null,
  "backupLocation" : "https://swiftobjectstorage.example.com/v1/
dbaasimage/backupbucket",
  "cfBackupHandle" : "c-2717054291-20180108-04",
  "spfBackupHandle" : "c-2717054291-20180108-04",
  "pitrTimeStamp" : "January 08, 2018 12:43:14 PM UTC",
  "pitrSCN" : "1175058",
  "resetLogsTimeStamp" : "January 08, 2018 09:55:34 AM UTC",
  "resetLogsSCN" : "1112268",
  "oraHomeVersion" : "12.2.0.1.170814 (26723265, 26609817)",
  "sqlPatches" : "25811364,26609817",

  "backupLogLoc" : "https://swiftobjectstorage.example.com/v1/dbaasimage/
backupbucket/scaoda702c1n1/rmanlog/ExampleDBu/2717054291/2018-01-08/
```

```
rman_backup_2018-01-08_12-42-41.0545.log",
  "tdeWalletLoc" : null,
  "dbConfigLoc" : "https://swiftobjectstorage.example.com/v1/dbaasimage/
backupbucket/scaoda702c1n1/dbconfig/ExampleDBu/2717054291/2018-01-08/
DBCONFIG_TAG20180108T124407_2018-01-08_12-44-07.0533.tar.gz",
  "name" : "Backup_Report_ExampleDB",
  "createTime" : "January 08, 2018 12:42:08 PM UTC",
  "state" : {
    "status" : "CONFIGURED"
  },
  "updatedAt" : "January 08, 2018 12:44:12 PM UTC",
  "backupReportLogDetail" :
"https://swiftobjectstorage.example.com/v1/dbaasimage/backupbucket/
scaoda702c1n1/rmandetaillogreport/ExampleDBu/2717054291/2018-01-08/
rman_list_backup_detail_2018-01-08_12-44-04.0362.log",
  "dbInfo" : {
    "dbClass" : "OLTP",
    "dbType" : "RAC",
    "dbShape" : "odbl",
    "dbEdition" : "EE",
    "dbStorage" : "ASM"
  },
  "dbDataSize" : "1542M",
  "dbRedoSize" : "16403M"
}
```

odacli delete-objectstoreswift

Use the command `odacli delete-objectstoreswift` to delete the credentials for the ObjectStore account.

File Path

```
$ORACLE_HOME/opt/oracle/dcs/bin/odacli
```

Syntax

```
# odacli delete-objectstoreswift [-h] [-j] -i Object Store Swift id
```

Parameters

Parameter	Description
<code>--help, -h</code>	(Optional) Displays help for using the command.
<code>--json, -j</code>	(Optional) Displays JSON output. The default is false.
<code>--objectstoreswiftid, -i</code>	Defines the Object Store Swift identifier (ID).

Usage Notes

You cannot delete the Object Store credentials if they are attached to a backup configuration.

Example 14-59 Deleting the Oracle Object Store Credentials

```
# odacli delete-objectstoreswift -i Object Store Swift id
```

odacli describe-schedule

Use the command `odacli describe-schedule` to display details for a specific schedule.

File Path

```
$ORACLE_HOME/opt/oracle/dcs/bin/odacli
```

Syntax

```
# odacli describe-schedule [-h] [-j] [-i]
```

Parameters

Parameter	Description
--help, -h	(Optional) Displays help for using the command.
--json, -j	(Optional) Displays JSON output. The default is false.
--scheduleid, -id	Defines the schedule with an identifier (ID).

Example 14-60 Display Schedule Details

```
# odacli describe-schedule -i scheduleid
```

odacli irestore-database

Use the command `odacli irestore-database` to restore a database from one system to other system from an external FRA (NFS) or Object Store location based on a BackupReport.

File Path

```
/opt/oracle/dcs/bin/odacli
```

Syntax

```
odacli irestore-database [-n] [-bp] [-r] [-cl] [-nn] [-co] [-s] [-ro]
[-dr] [-y] [-h] [-j] [-c] [-oid] [-tf] [-bl] [-rDBID] [-sh|-no-sh] [-t]
[-tl] [-cp]
```

Parameters

Parameter	Description
<code>--backupPassword(s), -bp</code>	(Optional) Defines the RMAN password for recovery. You can provide more than one password, but the passwords must be separated by a comma(,).
<code>--backupReport, -r</code>	JSON input for a backup report.
<code>--dbClass, -cl {EE: OLTP/DSS/IMDB, SE: OLTP}</code>	(Optional) Defines the Database class.
<code>--dbConsoleEnable, -co</code>	(Optional) Enables the Database Console.
<code>--dbShape, -s {odb1,odb2, and so on}</code>	(Optional) Defines the database shape.
<code>--dbStorage, -dr {ACFS ASM}</code>	(Optional) Defines the database storage. Database Storage {ACFS ASM} (non case-sensitive). The default is ASM.
<code>--dbType, -y</code>	(Optional) Defines the type of database. The default is single instance (SI).
<code>--dbEdition, -de</code>	(Optional) Defines the Database Edition (SE or EE).
<code>--databaseHome, -dh</code>	(Optional) Defines the database home.
<code>--dbName, -n</code>	(Optional) Defines the database name.
<code>--dbUniqueName, -u</code>	(Optional) Defines the database unique name.
<code>--dbDomainName, -dn</code>	Defines the database domain name.
<code>--dbrole, -ro</code>	Defines the database role for Oracle Data Guard operations. The options are PRIMARY STANDBY.
<code>--help, -h</code>	(Optional) Displays help for using the command.
<code>--json, -j</code>	(Optional) Displays JSON output. The default is false.
<code>--enable-tde, -t</code>	(Optional) Specifies whether you want to enable TDE on the target database.
<code>--tde-backup-location, -tl</code>	(Optional) Specifies the backup location for TDE wallet.
<code>--noOfRmanChannels, -c</code>	(Optional) Defines the number of RMAN channels (parallelism) Default: SE Edition: 1, Other Enterprise Editions: 5
<code>--objectStoreId, -oid</code>	Defines the Swift Object Store credential ID.
<code>--objectStoreName, -on</code>	Defines the Swift Object Store resource name.
<code>--backuplocation, -bl</code>	(Optional) Specifies the NFS or local directory path where backups are available.

Parameter	Description
<code>--dbRedundancy, -rd</code>	Specifies the database redundancy value, that is, {HIGH MIRROR}. To specify the <code>dbRedundancy</code> option for an Oracle ASM or ACFS storage-based database, at least one disk group of FLEX redundancy must exist. To specify the <code>dbRedundancy</code> option for an Oracle ASM storage database, the <code>dbVersion</code> or <code>dbHomeVersion</code> must be 12.2 or later. The precedence logic for setting the <code>dbRedundancy</code> is: <ol style="list-style-type: none"> 1. <code>dbRedundancy</code> that is specified in the <code>irestore-database</code> command. 2. <code>dbRedundancy</code> in the backup report. 3. If the disk group redundancy is FLEX, then the default <code>dbRedundancy</code> value is MIRROR.
<code>--resetDBID, -rDBID</code>	Resets the DB ID. The default is TRUE.
<code>--associated-networks, -nn</code>	Specifies the associated network names (in the format <code>networkName1,networkName2,...</code>).
<code>--disable-seha, -no-sh</code>	(Optional) Specifies whether you want to disable Standard Edition High-Availability for Oracle Database Standard Edition 19c and later single-instance databases.
<code>--enable-seha, -sh</code>	(Optional) Specifies whether you want to enable Standard Edition High-Availability for Oracle Database Standard Edition 19c and later single-instance databases.
<code>--dbOnFlashStorage, -f</code>	(Optional) Specifies whether to enable data on Flash storage.
<code>--no-dbOnFlashStorage, -no-f</code>	(Optional) Specifies whether to disable data on Flash storage.
<code>--cpupool, -cp</code>	(Optional) Specifies the CPU pool name.

Usage Notes

Caution:

When you create a database with Transparent Data Encryption (TDE) enabled, you are prompted to set a password for the TDE wallet. Provide a strong password for security compliance. Set the password carefully, and ensure that this password is available to you at all times for database management operations. Failure to provide the TDE wallet password when prompted, will cause an error in accessing encrypted data.

- The command `odacli irestore-database` restores a database to a system using the Backup Report that is in the Oracle Object Store or External FRA (NFS) location. You can restore a database from one appliance to another appliance, or to the same appliance after the source database is deleted.

- An Oracle wallet (ObjectStoreSwift credentials) must be created to access the backups in Oracle Object Store. This command performs the environment checks, validation checks, and tasks needed to restore a database to an Oracle Database Appliance system.
- If `-cp` parameter is provided as part of the command, the database is associated with the particular CPU pool.
- If `-cp` parameter is not provided as part of the command, and if the backup report has information about the associated CPU pool, then the command validates the CPU pool specified in the backup report. If the validation fails, then an error message is displayed.
- If the backup report does not have information about any associated CPU pool, then the database is created without being associated with any CPU pool.
- To restore a TDE-enabled database, the TDE wallet password must be provided.
- If source database is TDE enabled, then the target database which was restored will also have TDE enabled.
- Specify the TDE wallet location if the backup report does not have TDE wallet location or if the backup report is inaccessible or unavailable.

Example 14-61 Restoring a Database to the Same System

Run the command `odacli irestore-database` with the backup report. Enter the SYS user password when prompted.

```
# odacli irestore-database -r backupreport.json -oid Object Store ID
```

Example 14-62 Restoring a Database to a Different System

To restore to a different system, copy the backup report to the other machine's `\bin` folder (or provide the complete path to the backup report), then run the command `odacli irestore-database` with the backup report. Enter the SYS user password when prompted.

```
# odacli irestore-database -r backupreport.json -oid Object Store ID
```

Example 14-63 Restoring a Database with TDE Wallet backup from a backup report

```
# odacli irestore-database -r backupreport.json -on oss1 -t  
Password for SYS user:  
Password for TDE Wallet:
```

Example 14-64 Restoring a Database with TDE Wallet backup specified on the CLI

```
# odacli irestore-database -r  
backupreport.json -tl https://swiftobjectstorage.us-  
ashburn-1.oraclecloud.com/v1/paas_test/tde_Backups/test2-c/database/  
91276171/tdbacf2/tdewallet/ewallet_2020021714442745.p12 -on oss2 -p -m  
Password for SYS user:  
Password for TDE Wallet:
```

Example 14-65 Restoring to a standby database when Oracle Data Guard is configured

```
# odacli irestore-database -r backup_report.json -u dbUniqueName -ro
STANDBY -ro STANDBY
```

Example 14-66 Recovering a Database that was associated with a CPU Pool

```
# odacli irestore-database -n irmendb3 -r dbcpupllong.json -on ostore
-bp -dh 45156cc5-e768-4817-8b52-2a0a482be18f
Rman Backup Encryption Password(s). Multiple passwords needs to be
comma separated:
Password for SYS user:
{
  "jobId" : "31af6cc8-5e04-459b-8017-271c55b8c99b",
  "status" : "Created",
  "message" : null,
  "reports" : [ ],
  "createTimestamp" : "August 10, 2020 11:20:08 AM UTC",
  "resourceList" : [ ],
  "description" : "Database service recovery with db name: irmendb3",
  "updatedAtTime" : "August 10, 2020 11:20:08 AM UTC"
}
```

odacli list-backupconfigs

Use the command `odacli list-backupconfigs` to list all backup configurations.

File Path

```
/opt/oracle/dcs/bin/odacli
```

Syntax

```
odacli list-backupconfigs [-h] [-j]
```

Parameters

Parameter	Description
<code>--help, -h</code>	(Optional) Displays help for using the command.
<code>--json, -j</code>	(Optional) Displays JSON output. The default is false.

Example 14-67 Displaying a List of Backup Configuration

Display a list of backup configurations.

```
# odacli list-backupconfigs -d Disk -n production -w 14
```

odacli list-backupreports

Use the command `odacli list-backupreports` to display a list of all backup reports.

File Path

`$ORACLE_HOME/opt/oracle/dcs/bin/odacli`

Syntax

```
# odacli list-backupreports [-h] [-j]
```

Parameters

Parameter	Description
<code>--help, -h</code>	(Optional) Displays help for using the command.
<code>--json, -j</code>	(Optional) Displays JSON output. The default is false.

Usage Notes

Displays a list of all database backup reports generated from the command `odacli create-backup`.

Example 14-68 Display a List of all Backup Reports

```
# odacli list-backupreports
```

odacli list-objectstoreswifts

Use the command `odacli list-objectstoreswifts` to display a list of credentials for the ObjectStore account.

File Path

`$ORACLE_HOME/opt/oracle/dcs/bin/odacli`

Syntax

```
# odacli list-objectstoreswifts [-h] [-j]
```

Parameters

Parameter	Description
<code>--help, -h</code>	(Optional) Displays help for using the command.
<code>--json, -j</code>	(Optional) Displays JSON output. The default is false.

Example 14-69 Displaying a List of ObjectStore Swift Credentials

```
# odacli list-objectstoreswifts
```

odacli list-schedules

Use the command `odacli list-schedules` to display all of the schedules in the system, including database backup schedules and some internal maintenance schedules.

File Path

```
$ORACLE_HOME/opt/oracle/dcs/bin/odacli
```

Syntax

```
# odacli list-schedules [-h] [-j]
```

Parameters

Parameter	Description
<code>--help, -h</code>	(Optional) Displays help for using the command.
<code>--json, -j</code>	(Optional) Displays JSON output. The default is false.

Usage Notes

The command lists all of the schedules in the system, including database backup schedules and some internal maintenance schedules.

Example 14-70 Display a List of Scheduled Database Backups

Display a list of all scheduled database backups and details.

```
# odacli list-schedules
ID                                     Name
Description
CronExpression                        Disabled
-----
-----
201672f6-c80c-4ff9-99be-2bc8be480e66  metastore maintenance
internal metastore maintenance        0 0 0 1/1 * ?
*                                     true
e86ff1e9-8607-41f8-8d0a-cf59dc1e52a9  AgentState metastore cleanup
internal agentstateentry metastore maintenance 0 0 0 1/1 * ?
*                                     true
17640773-aa8b-4b4f-b170-3a68d5329cbb  bom maintenance
reports generation                    0 0 1 ? * SUN
*                                     true
cae98cb1-e8ab-48c6-aaf9-22d9ab4097b1  Big File Upload Cleanup
clean up expired big file uploads.    0 0 1 ? * SUN
```

```

*           true
745333ad-8845-4444-b591-7ca7d19a4d91   feature_tracking_job
Feature tracking job                       0 0 20 ? * WED
*           true
42b6894f-f680-4316-9958-f4ecf501d781   Log files Cleanup           Auto
log file purge bases on policy           0 0 3 1/1 * ?
*           true

```

odacli list-tdebackupreports

Use the `odacli list-tdebackupreports` command to view TDE Wallet backup reports.

File Path

`/opt/oracle/dcs/bin/odacli`

Syntax

```
odacli list-tdebackupreports [-h] [-j]
```

Parameters

Parameter	Description
<code>--help, -h</code>	(Optional) Displays help for using the command.
<code>--json, -j</code>	(Optional) Displays JSON output. The default is false.

Usage Notes

The TDE backup report saves the latest TDE Wallet backup location of a TDE-enabled database, when a database backup or a TDE Wallet backup is taken for that database.

Example 14-71 Viewing the TDE backup report

```

# odacli list-tdebackupreports
DbResID                               OraDbId
BackupLocation
-----
49772c1b-e4e4-401b-a5f0-16c7992d6766
1080131389                             https://swiftobjectstorage.us-
ashburn-1.oraclecloud.com/v1/paastest/TestLtBackupFailur/test2-c/
database/1080131389/tddb3/tdewallet/ewallet_2020053120350968.p12
f1043fa4-b1ee-461b-84d6-8541e4f6f053   1052183392                       /u01/
NFS_TDE/orabackups/test2-c/database/1052183392/tddb4/tdewallet/
ewallet_2020060102471941.p12
944a5613-2alf-41fb-b7b1-91d35e3e8530   1002460890                       /u03/app/
oracle/fast_recovery_area/TDD5/tdewallet/ewallet_2020060103125231.

```

odacli recover-database

Use the `odacli recover-database` command to recover or restore a database from backup.

File Path

`/opt/oracle/dcs/bin/odacli`

Syntax

```
odacli recover-database -i Database Resource ID [-br] [-i] [-h] [-j]
[-r] [-t] [-p] [-s] [-in] [-tp] [-tl] [-cp]
```

Parameters

Parameter	Description
<code>--backupReport, -br{Regular-L0 Regular-L1 Longterm}</code>	(Optional) JSON input for a backup report.
<code>--dbName, -in</code>	Defines the Database Name.
<code>--dbid, -i</code>	Defines the Database Resource ID.
<code>--help, -h</code>	(Optional) Displays help for using the command.
<code>--json, -j</code>	(Optional) Displays JSON output. The default is false.
<code>--tde-backup-location, -tl</code>	(Optional) Specifies the backup location for TDE wallet. If not specified, the latest known TDE backup location is used.
<code>--recoveryTimeStamp, -r</code>	(Optional) Defines the date and time of the backup. The Recovery Timestamp (in format mm/dd/yyyy hh:mm:ss) is required when the recovery is a point in time recovery (PITR).
<code>--recoverytype, -t {Latest PITR SCN}</code>	(Optional) Defines the recovery type. Do not provide the recovery type if you define the Backup Report.
<code>--rmanrecoverypassword(s), -p</code>	(Optional) Defines the password for recovery. You can provide more than one password, but the passwords must be within single quote separated by comma(.).
<code>--scn, -s</code>	(Optional) Defines the SCN recovery type. Required when the RecoveryType is SCN.
<code>--cpupool, -cp</code>	(Optional) Specifies the CPU pool name.

Usage Notes

Recovers a database to the latest, a point in time recovery (PITR), or System Change Number (SCN) as input. You can also recover a database from a Backup Report provided as JSON input file.

This command performs various environment and validation checks in order to attempt to ensure that recovery of database is successful. If backups are in ObjectStore, the RMAN recovery passwords are needed to recover the database. This includes RMAN restore and recovery.

This command always performs a full RMAN database restore and recovery. This command is most useful when there is a complete database loss or when the majority of the database files are lost. If you do not require a full RMAN restore, you can perform a manual recovery. For example, a single data file loss or control file loss.

- If `-cp` parameter is provided as part of the command, recovered database is associated with the particular CPU pool.
- If `-cp` parameter is not provided as part of the command, and if the backup report has information about the associated CPU pool, then the recovered database is also associated with the same CPU pool.
- If the original database does not have any associated CPU pool, then the recovered database is also not associated with any CPU pool.

Example 14-72 Recovering a Database to a Point-in-Time

```
# odacli recover-database -i b5fc646e-01a6-4c8b-8286-7633346c4 -t PITR
-r 11/08/2017 12:57:33 -p
```

Example 14-73 Recovering a Database to the latest

```
# odacli recover-database -i b5fc646e-01a6-4c8b-8286-7633346c4 -t
Latest -p
```

Example 14-74 Recovering a Database to an SCN

```
# odacli recover-database -i b5fc646e-01a6-4c8b-8286-7633346c4 -t SCN
-s 392375947
```

Example 14-75 Restoring the TDE Wallet while performing database recovery, if TDE wallets are lost

```
# odacli recover-database -in db1 -t latest -tp -
t1 /u01/NFS_TDE/testbackups/test2-c/database/91276171/tdbacf2/tdewallet/
ewallet_2020021714442745.p12
Enter new 'TDE wallet' password:
Confirm 'TDE wallet' password:
```

Example 14-76 Recovering a Database that was associated with a CPU Pool

```
# odacli recover-database -t latest -in irmendb4 -cp testcpupool3
{
  "jobId" : "b09f2d3f-2b01-4dbb-9797-122ba786e0e4",
  "status" : "Created",
  "message" : null,
  "reports" : [ ],
  "createTimestamp" : "August 10, 2020 14:56:57 PM UTC",
  "resourceList" : [ ],
  "description" : "Create recovery-latest for db : irmendb4",
  "updatedAtTime" : "August 10, 2020 14:56:57 PM UTC"
}
```

odacli restore-archivelog

Use the `odacli restore-archivelog` command to restore archivelog from one SCN to another SCN, or from one timestamp to another timestamp.

File Path

```
/opt/oracle/dcs/bin/odacli
```

Syntax

```
odacli restore-archivelog -fs from_scn -ts to_scn -ft from_timestamp  
-tt to_timestamp [-h] [-j]
```

Parameters

Parameter	Description
<code>--dbname, -in</code>	Specifies the Database Name.
<code>--dbid, -i</code>	(Optional) Specifies the Database resource ID.
<code>--from-scn, -fs</code>	(Optional) Specifies the start SCN of archivelog restore.
<code>--from-timestamp, -ft</code>	(Optional) Specifies the start time of archivelog restore (in the format mm/dd/yyyy hh:mi:ss).
<code>--to-scn, -ts</code>	(Optional) Specifies the end SCN of archivelog restore.
<code>--to-timestamp, -tt</code>	(Optional) Specifies the end time of archivelog restore (in the format mm/dd/yyyy hh:mi:ss).
<code>--help, -h</code>	(Optional) Displays help for using the command.
<code>--json, -j</code>	(Optional) Displays JSON output. The default is false.

Usage Notes

You can restore archivelog for all supported database versions and database types for an Oracle Database Appliance release.

Example 14-77 Restoring archivelog

```
# odacli restore-archivelog -fs from_scn -ts to_scn  
# odacli restore-archivelog -ft from_timestamp -tt to_timestamp
```

odacli restore-tdewallet

Use the `odacli restore-tdewallet` command to recover or restore TDE wallet from the backup location.

File Path

```
/opt/oracle/dcs/bin/odacli
```

Syntax

```
odacli restore-tdewallet [-in] [-tl] [-h] [-j]
```

Parameters

Parameter	Description
--dbname, -in	Specifies the Database Name.
--tde-backup-location, -tl	(Optional) Specifies the backup location for TDE wallet.
--help, -h	(Optional) Displays help for using the command.
--json, -j	(Optional) Displays JSON output. The default is false.

Usage Notes

▲ Caution:

When you create a database with Transparent Data Encryption (TDE) enabled, you are prompted to set a password for the TDE wallet. Provide a strong password for security compliance. Set the password carefully, and ensure that this password is available to you at all times for database management operations. Failure to provide the TDE wallet password when prompted, will cause an error in accessing encrypted data.

- This command prompts for TDE wallet password. When prompted, enter the password of the TDE wallet. This password is the one you created or last updated using the modify-database command.
- TDE Wallet backup location is optional. If no TDE Wallet backup location is provided, then the latest TDE Wallet backup of the database known to the system is used for restoring the TDE Wallet.

Example 14-78 Restoring TDE wallet for a database from a backup location

```
# odacli restore-tdewallet -in testdb -tl /u01/NFS_TDE/testbackups/
test2-c/database/91276171/tdbacf2/tdewallet/ewallet_2020021714442745.p12
Enter current 'TDE wallet' password:
```

odacli update-backupconfig

Use the command `odacli update-backupconfig` to update a backup configuration.

File Path

```
$ORACLE_HOME/opt/oracle/dcs/bin/odacli
```

Syntax

```
odacli update-backupconfig -n backup configuration name [-i] [-in]
[-ca] -d backup destination{Disk|ObjectStore|None} [-c] [-cr] [-h] [-j]
[-no-cr] [-o][-w]
```

Parameters

Parameter	Description
--backupconfigid, -i	Defines the Backup Config ID.
--backupconfigname, -in	Defines the Backup Config name.
--backupdestination, -d{Disk ObjectStore None}	Defines the backup destination. The options are not case sensitive. Applicable to System type backup config.
--compression-algo, -ca{BASIC LOW MEDIUM HIGH}	Defines the Compression Algorithm that RMAN must use. The default is BASIC for Disk and NFS backup and MEDIUM for ObjectStore backup.
--container, -c	(Optional) Defines the object store container or absolute path to the parent directory of NFS destination for backups.
--crosscheck, -cr	(Optional) Enable Crosscheck. Applicable to Database type backup config.
--help, -h	(Optional) Displays help for using the command.
--json, -j	(Optional) Displays JSON output. The default is false.
--name, -n	Defines the backup configuration name.
--no-crosscheck, -no-cr	(Optional) Disable crosscheck.
--objectstoreswiftId, -o	(Optional) Defines the swift object store credential ID.
--recoverywindow, -w Disk: {1-14} ObjectStore: {1-30}	(Optional) Defines the Recovery Window in days. {1-14} days for Disk and {1-30} days for Object store. Applicable to Database type backup config.

Usage Notes

- The recovery window that is defined in the backup configuration determines when backups are considered obsolete. The following are guidelines:
 - Disk: 1-14 days
 - ObjectStore in Casper: 1-30 days

Example 14-79 Revise a Backup Configuration for Disk

Create a backup configuration named `production` that backs up to disk with a 14 day recovery window.

```
# odacli update-backupconfig -d Disk -n production -w 14
```

odacli update-objectstoreswift

Use the command `odacli update-objectstoreswift` to change the credentials for the ObjectStore account.

File Path

```
/opt/oracle/dcs/bin/odacli
```

Syntax

```
# odacli update-objectstoreswift [-h] [-j] -i Object Store Swift id [-p] [-u] Object Store user name
```

Parameters

Parameter	Description
<code>--help, -h</code>	(Optional) Displays help for using the command.
<code>--json, -j</code>	(Optional) Displays JSON output. The default is false.
<code>--objectstoreswiftid, -i</code>	Defines the Object Store Swift identifier (ID).
<code>--swiftpassword, -p</code>	(Optional) Defines the Object Store Swift password.
<code>--username, -u</code>	(Optional) Defines the Object Store Swift user name.

Usage Notes

Use this command to update the password when it is changed for an ObjectStore account. The command updates the Oracle ObjectStore credential details in the system and stores the password in an encrypted Oracle wallet.

The credentials are validated during the command `odacli update-backupconfig` with `objectstore` as the destination. The credentials are not validated against endpoint URL and tenancy.

Example 14-80 Changing the Oracle Casper ObjectStore Password

```
# odacli update-objectstoreswift -i Object Store Swift id -p
```

Example 14-81 Changing the Oracle ObjectStore User Name

```
# odacli update-objectstoreswift -i Object Store Swift id -u Object Store user name
```

odacli update-schedule

Use the command `odacli update-schedule` to update the schedule for a database, or to disable the database backup schedule.

File Path

```
$ORACLE_HOME/opt/oracle/dcs/bin/odacli
```

Syntax

```
# odacli update-schedule [-x] [-t] [-d] [-e] [-h] [-j] [-id]
```

Parameters

Parameter	Description
<code>--cronExpression, -x</code>	(Optional) Defines the date and time for the update.
<code>--description, -t</code>	(Optional) Provides a description for the update schedule.
<code>--disable, -d</code>	(Optional) Disables the schedule.
<code>--enable, -e</code>	(Optional) Enables a disabled schedule.
<code>--help, -h</code>	(Optional) Displays help for using the command.
<code>--json, -j</code>	(Optional) Displays JSON output. The default is false.
<code>--scheduleid, -id</code>	Defines the schedule with an identifier (ID).

Usage Notes

Backups incur overhead on the system. When possible, do not schedule backups to run when users are trying to access data.

Use a utility, such as www.croncronmaker.com, to generate a valid cron expression.

Example 14-82 Change What Time the Backup Occurs

Edit the cron expression to change the time of scheduled backups for a given schedule ID.

```
# odacli update-schedule -i scheduleid -x "0 0 13 1/1 * ? *" -e
```

Example 14-83 Disable Scheduled Database Backups

```
# odacli update-schedule -i scheduleid -d
```

Oracle Data Guard odacli Commands

Use ODACLI commands to configure and manage Oracle Data Guard in your Oracle Database Appliance deployment.

- [odacli configure-dataguard](#)
Use the command `odacli configure-dataguard` to configure Oracle Data Guard on Oracle Database Appliance.
- [odacli deconfigure-dataguard](#)
Use the command `odacli deconfigure-dataguard` to deconfigure Oracle Data Guard on Oracle Database Appliance.
- [odacli describe-dataguardstatus](#)
Use the command `odacli describe-dataguardstatus` to view Oracle Data Guard status on Oracle Database Appliance.
- [odacli failover-dataguard](#)
Use the command `odacli failover-dataguard` on the standby system to failover the Oracle Data Guard primary database to the standby database.
- [odacli list-dataguardstatus](#)
Use the command `odacli list-dataguardstatus` to verify Oracle Data Guard status on both primary and standby databases.
- [odacli reinstate-dataguard](#)
Use the command `odacli reinstate-dataguard` on the new primary system to reinstate a failed primary database after a failover and convert it to a new standby database.
- [odacli switchover-dataguard](#)
Use the command `odacli switchover-dataguard` on the primary system to reverse the Oracle Data Guard primary and standby database roles on Oracle Database Appliance.

odacli configure-dataguard

Use the command `odacli configure-dataguard` to configure Oracle Data Guard on Oracle Database Appliance.

File Path

`/opt/oracle/dcs/bin/odacli`

Syntax

```
# odacli configure-dataguard [-h] [-j] [-i] [-r] [-s]
```

Parameters

Parameter	Description
<code>--help, -h</code>	(Optional) Displays help for using the command.
<code>--json, -j</code>	(Optional) Displays JSON output. The default is false.
<code>--requestjson, -r</code>	(Optional) Specifies the JSON file for creating the appliance.
<code>--skip-password-copy, -s</code>	(Optional) Specifies that step to copy the password from primary database to standby database can be skipped.

Usage Notes

If the database orapwd file is not in the typical location, then an error may occur in the configuration process. In such a case, manually copy the orapwd file from the primary database to the standby database in advance, and configure Oracle Data Guard with the `--skip-password-copy` option.

Example 14-84 Configuring Oracle Data Guard interactively on the command line

```
# odacli configure-dataguard
Standby site address: test_domain
BUI username for Standby site (default: oda-admin):
BUI password for Standby site:
TrustStore path for Standby DCS server: /cacerts.a
TrustStore password for Standby DCS server: <TrustStore_Password>
Database name for Data Guard configuration: cpub
Primary database syspassword:
*****
*****
Data Guard default settings
Primary site network for Data Guard configuration: Public-network
Standby site network for Data Guard configuration: Public-network
Primary database listener port: 1521
Standby database listener port: 1521
Transport type: ASYNC
Protection mode: MAX_PERFORMANCE
Data Guard configuration name: pcpub_scpub
Active Data Guard: disabled
Do you want to edit this Data Guard configuration? (Y/N, default:N):
The TrustStore of the Standby site should be removed unless it is
necessary for some other purpose. Do you want to delete it? (Y/N,
default:Y): n
As a requirement, Standby database's SYS password will be set to
Primary database's after Data Guard configuration. Are you sure you
want to proceed with Data Guard configuration? (Y/N): y
*****
*****
Configure Data Guard pcpub_scpub started
*****
*****
Step 1: Validate Data Guard configuration request (Primary site)
Description: Validate DG Config Creation
Job ID: bafb8ef4-d3c9-4421-84a1-4c75d73e71a0
Started August 25, 2020 05:51:20 UTC
Validate create Data Guard configuration request
Finished August 25, 2020 05:51:27 UTC
*****
*****
Step 2: Validate Data Guard configuration request (Standby site)
Description: Validate DG Config Creation
Job ID: a7b80880-40ab-4dbf-b8be-22717ae87711
Started August 25, 2020 05:51:27 UTC
Validate create Data Guard configuration request
```



```
Finished August 25, 2020 05:51:33 UTC
*****
*****
Step 3: Download password file from Primary database (Primary site)
Description: Download orapwd file from Primary database
Started August 25, 2020 05:51:33 UTC
Prepare orapwd file for Primary database cpub
Finished August 25, 2020 05:51:38 UTC
*****
*****
Step 4: Upload password file to Standby database (Standby site)
Description: Upload orapwd file to Standby database
Started August 25, 2020 05:51:38 UTC
Write orapwd file to Standby database cpub
Finished August 25, 2020 05:51:47 UTC
*****
*****
Step 5: Configure Primary database (Primary site)
Description: DG Config service creation - ConfigurePrimary
Job ID: b6726f76-0a3a-4bb1-8fec-a3eb311531cf
Started August 25, 2020 05:51:47 UTC
Configure host DNS on primary env
Configure Data Guard Tns on primary env
Enable Data Guard related Db parameters for primary env
Enable force logging and archivelog mode in primary env
Enable FlashBac
Configure network parameters for local listener on primary env
Restart listener on primary env
Create services for primary db
Finished August 25, 2020 05:52:10 UTC
*****
*****
Step 6: Configure Standby database (Standby site)
Description: DG Config service creation - ConfigureStandby
Job ID: e6b552be-fef0-4cd6-a61d-81292f957a6e
Started August 25, 2020 05:52:10 UTC
Configure Data Guard Tns on standby env
Configure host DNS on standby env
Clear Data Guard related Db parameters for standby env
Enable Data Guard related Db parameters for standby env
Enable force logging and archivelog mode in standby env
Populate standby database metadata
Configure network parameters for local listener on standby env
Reset Db sizing and hidden parameters for ODA best practice
Restart Listener on standby env
Create services for standby db
Finished August 25, 2020 05:53:40 UTC
*****
*****
Step 7: Configure and enable Data Guard (Primary site)
Description: DG Config service creation - ConfigureDg
Job ID: 0b79511f-794a-4bc2-936d-5c651110467f
Started August 25, 2020 05:53:40 UTC
Config and enable Data Guard
Post check Data Guard configuration
```

```

Finished August 25, 2020 05:55:06 UTC
*****
*****
Step 8: Enable Flashback (Standby site)
Description: DG Config service creation - EnableFlashback
Job ID: b526445e-67df-4c35-a7ca-8420298b8bd2
Started August 25, 2020 05:55:06 UTC
Enable FlashBack
Finished August 25, 2020 05:55:17 UTC
*****
*****
Step 9: Re-enable Data Guard (Primary site)
Description: DG Config service creation - ReenableDg
Job ID: 4833133f-da65-44a9-beb7-2c4d347c9120
Started August 25, 2020 05:55:23 UTC
Re-enable Data Guard if inconsistent properties found
Post check Data Guard configuration
Finished August 25, 2020 05:55:29 UTC
*****
*****
Step 10: Create Data Guard status (Primary site)
Description: DG Status service creation - NewDgconfig
Job ID: 430d0613-bcd3-4e34-9418-c5f4dfddc052
Started August 25, 2020 05:55:33 UTC
Create Data Guard status
Finished August 25, 2020 05:55:37 UTC
*****
*****
Step 11: Create Data Guard status (Standby site)
Description: DG Status service creation - NewDgconfig
Job ID: 93bcdd39-657f-4d7c-b893-c50dc5e708c4
Started August 25, 2020 05:55:40 UTC
Create Data Guard status
Finished August 25, 2020 05:55:43 UTC
*****
*****
Configure Data Guard pcpub_scpub completed
*****
*****

```

Example 14-85 Configuring Oracle Data Guard using JSON file

```

# odacli configure-dataguard -r configdg_ODA_HA.json
Standby machine address: 192.214.108.19
BUI username for Standby machine (default: oda-admin):
BUI password for Standby machine:
TrustStore path for Standby DCS server (copy from /opt/oracle/dcs/
dcscli/cacerts on Standby machine to this machine and set file
permissions to 400): /cacerts.a
TrustStore password for Standby DCS server: (can be found in /opt/
oracle/dcs/dcscli/dcscli.conf)
Primary database syspassword:
Standby database syspassword (default: same as primary):
The TrustStore of the Standby machine should be removed unless it is

```

```
necessary for some other purpose. Do you want to delete it? (Y/N,
default:Y): n
As a requirement, Standby database's SYS password will be set to
Primary database's after Data Guard configuration. Are you sure you
want to proceed? (Y/N): y
Data Guard configuration for database 'test' started
*****
*****
Step 1: Validate Data Guard configuration request (Primary machine)
.....
```

Example 14-86 Sample JSON for configuring Oracle Data Guard on Oracle Database Appliance High-Availability Deployments

```
{
  "name": "pink1_pink7",
  "protectionMode": "MAX_PERFORMANCE",
  "enableFlashback": true,
  "enableActiveDg": false,
  "replicationGroups": [
    {
      "sourceEndPoints": [
        {
          "endpointType": "PRIMARY",
          "hostName": "test_domain1",
          "listenerPort": 1521,
          "databaseUniqueName": "pink1",
          "ipAddress": "192.214.96.214"
        },
        {
          "endpointType": "PRIMARY",
          "hostName": "test_domain2",
          "listenerPort": 1521,
          "databaseUniqueName": "pink1",
          "ipAddress": "192.214.96.215"
        }
      ],
      "targetEndPoints": [
        {
          "endpointType": "STANDBY",
          "hostName": "test_domain1",
          "listenerPort": 1521,
          "databaseUniqueName": "pink7",
          "ipAddress": "192.214.108.19"
        },
        {
          "endpointType": "STANDBY",
          "hostName": "test_domain2",
          "listenerPort": 1521,
          "databaseUniqueName": "pink7",
          "ipAddress": "192.214.108.20"
        }
      ],
      "transportType": "ASYNC"
    }
  ]
}
```

```
}
 ]
}
```

odacli deconfigure-dataguard

Use the command `odacli deconfigure-dataguard` to deconfigure Oracle Data Guard on Oracle Database Appliance.

File Path

`/opt/oracle/dcs/bin/odacli`

Syntax

```
# odacli deconfigure-dataguard [-h] [-j] [-i]
```

Parameters

Parameter	Description
<code>--help, -h</code>	(Optional) Displays help for using the command.
<code>--json, -j</code>	(Optional) Displays JSON output. The default is false.
<code>--dgconfigid, -i</code>	Specifies the Oracle Data Guard Configuration ID.

Usage Notes

For deconfiguring Oracle Data Guard, you must specify the Oracle Data Guard Configuration ID. Run the `odacli list-dataguardstatus` command to find the Oracle Data Guard Configuration ID.

Example 14-87 Deconfiguring Oracle Data Guard on the Primary Machine

```
# odacli deconfigure-dataguard -i 8396aac4-f7e7-42e4-a2e8-0cbbc89ce31b
Standby site address: test_domain
BUI username for Standby site (default: oda-admin):
BUI password for Standby site:
TrustStore path for Standby DCS server : /cacerts.a
TrustStore password for Standby DCS server: TrustStore_Password
The TrustStore of the Standby site should be removed unless it is
necessary for some other purpose. Do you want to delete it? (Y/N,
default:Y): n
Standby database will be deleted after Data Guard configuration is
removed. Are you sure you want to proceed? (Y/N): y
Deconfigure Dataguard Started
*****
*****
Step 1: Deconfigure Data Guard (Primary site)
Description: Deconfigure DG service
Job ID: 8deb3e4c-09cd-4593-8184-f7706dd2ec8a
Started
```

```

Deconfigure Data Guard service
Cleanup broker resources
Finished
*****
*****
Step 2: Delete Data Guard status (Primary site)
Description: DG Status service creation - UpdateDgconfig
Job ID: 59c61629-6c7d-474c-8c29-c0a9565d91a3
Started
Update Data Guard status
Finished
*****
*****
Step 3: Delete Data Guard status (Standby site)
Description: DG Status service creation - UpdateDgconfig
Job ID: 93dcf4cd-1019-4bcd-984a-d3efeb3fae6e
Started
Update Data Guard status
Finished
*****
*****
Step 4: Delete Standby database (Standby site)
Description: Database service deletion with db name: panda with id :
30dd49da-a54f-4a9a-abbf-d3a4e39abee5
Job ID: 0b1cb921-fd41-4e01-86df-beff3adb6de0
Started
Validate db 30dd49da-a54f-4a9a-abbf-d3a4e39abee5 for deletion
Database Deletion
Unregister Db From Cluster
Kill Pmon Process
Database Files Deletion
Deleting Volume
Delete File Groups of Database panda
Finished
*****
*****
Data Guard configuration is removed

```

odacli describe-dataguardstatus

Use the command `odacli describe-dataguardstatus` to view Oracle Data Guard status on Oracle Database Appliance.

File Path

`/opt/oracle/dcs/bin/odacli`

Syntax

```
# odacli describe-dataguardstatus [-h] [-j] [-i]
```

Parameters

Parameter	Description
--help, -h	(Optional) Displays help for using the command.
--json, -j	(Optional) Displays JSON output. The default is false.
--dgid, -i	Specifies the Oracle Data Guard Status ID.

Usage Notes**Example 14-88 Viewing Oracle Data Guard configuration status**

```
# odacli describe-dataguardstatus -i 5f0ed48a-366d-454c-a389-
fe367772dbb7
```

odacli failover-dataguard

Use the command `odacli failover-dataguard` on the standby system to failover the Oracle Data Guard primary database to the standby database.

File Path

```
/opt/oracle/dcs/bin/odacli
```

Syntax

```
# odacli failover-dataguard [-h] [-j] [-i] [-u]
```

Parameters

Parameter	Description
--help, -h	(Optional) Displays help for using the command.
--json, -j	(Optional) Displays JSON output. The default is false.
--dgid, -i	Specifies the Oracle Data Guard Status ID.
--databaseUniqueName, -u	Specifies the unique name of the database to failover to.

Usage Notes

After performing the failover, view the status with the `odacli list-dataguardstatus` command.

Example 14-89 Performing Failover Oracle Data Guard

```
# odacli failover-dataguard -i 75f23ce0-006a-4aeb-ba6d-b4b60275c19 -u
houdg02
```

odacli list-dataguardstatus

Use the command `odacli list-dataguardstatus` to verify Oracle Data Guard status on both primary and standby databases.

File Path

`/opt/oracle/dcs/bin/odacli`

Syntax

```
# odacli list-dataguardstatus [-h] [-j]
```

Parameters

Parameter	Description
<code>--help, -h</code>	(Optional) Displays help for using the command.
<code>--json, -j</code>	(Optional) Displays JSON output. The default is false.

Usage Notes

Example 14-90 Viewing Oracle Data Guard status on primary and standby databases

```
# odacli list-dataguardstatus
```

odacli reinstate-dataguard

Use the command `odacli reinstate-dataguard` on the new primary system to reinstate a failed primary database after a failover and convert it to a new standby database.

File Path

`/opt/oracle/dcs/bin/odacli`

Syntax

```
# odacli reinstate-dataguard [-h] [-j] [-i] [-u]
```

Parameters

Parameter	Description
<code>--help, -h</code>	(Optional) Displays help for using the command.
<code>--json, -j</code>	(Optional) Displays JSON output. The default is false.

Parameter	Description
--dgid, -i	Specifies the Oracle Data Guard Status ID.
--databaseUniqueName, -u	(Optional) Specifies the unique name of the database to reinstate.

Usage Notes

After completing the reinstate operation, view the status with the `odacli list-dataguardstatus` command.

Example 14-91 Performing reinstate operation on Oracle Data Guard

```
# odacli reinstate-dataguard -i 75f23ce0-006a-4aeb-ba6d-b4b60275c19 -u
houdg02
```

odacli switchover-dataguard

Use the command `odacli switchover-dataguard` on the primary system to reverse the Oracle Data Guard primary and standby database roles on Oracle Database Appliance.

File Path

```
/opt/oracle/dcs/bin/odacli
```

Syntax

```
# odacli switchover-dataguard [-h] [-j] [-i] [-u]
```

Parameters

Parameter	Description
--help, -h	(Optional) Displays help for using the command.
--json, -j	(Optional) Displays JSON output. The default is false.
--dgid, -i	Specifies the Oracle Data Guard Status ID.
--databaseUniqueName, -u	(Optional) Specifies the unique name of the database to switchover to.

Usage Notes

After performing the switchover, view the status with the `odacli list-dataguardstatus` command.

Example 14-92 Switching over Oracle Data Guard

```
# odacli switchover-dataguard -i 75f23ce0-006a-4aeb-ba6d-b4b60275c19 -u
houdg02
```

odacli CPU Core Commands

Use the CPU Core commands to enable CPU cores and display current and historical CPU core configurations.

- [odacli list-cpucores](#)
Use the `odacli list-cpucores` command lists the history of core configuration changes in the system.
- [odacli describe-cpucore](#)
Use the `odacli describe-cpucore` command to display the current core configuration and the modification date and time.
- [update-cpucore](#)
Use the `odacli update-cpucore` command to enable the number of CPU cores in the system.

odacli list-cpucores

Use the `odacli list-cpucores` command lists the history of core configuration changes in the system.

File Path

`$ORACLE_HOME/opt/oracle/dcs/bin/odacli`

Syntax

`odacli list-cpucores [-h]`

Parameters

Parameter	Description
<code>--help, -h</code>	(Optional) Displays help for using the command.

Example 14-93 Displaying a List of Cores

```
# odacli list-cpucores
```

```
Node  Cores  Modified                               Job Status
-----
0      10     July 22, 2016 12:06:08 PM SGT    Configured
0       8     July 25, 2016 9:39:59 AM SGT    Configured
```

odacli describe-cpucore

Use the `odacli describe-cpucore` command to display the current core configuration and the modification date and time.

File Path

```
/opt/oracle/dcs/bin/odacli
```

Syntax

```
odacli describe-cpucore [-h]
```

Parameters

Parameter	Description
<code>--help, -h</code>	(Optional) Displays help for using the command.

Example 14-94 Displaying the Current Core Configuration

```
# odacli describe-cpucore
```

```
Node Cores Modified Job Status
-----
0      8    July 25, 2016 9:39:59 AM SGT Configured
```

update-cpucore

Use the `odacli update-cpucore` command to enable the number of CPU cores in the system.

File Path

```
/opt/oracle/dcs/bin/odacli
```

Syntax

```
odacli update-cpucore -c cores [-h]
```

Parameters

Parameter	Description
<code>--cores, -c</code>	Defines the number of cores to be enabled in the system.
<code>--help, -h</code>	(Optional) Displays help for using the command.

Usage Notes

- The number of cores you enable must be a multiple of 2.
- After the initial configuration, you cannot reduce the number of cores. You can only increase the number of cores.

Example 14-95 Enabling CPU Cores

The following command enables 8 CPU cores.

```
# odacli update-cpucore -c 8

{
"jobId" : "2807f6ae-3ba5-48a5-8941-b8b365d89d24",
"status" : "Created",
"message" : null,
"reports" : [ ],
"createTimestamp" : 1469410799194,
"description" : "CPU cores service update",
"updatedAt" : 1469410799194
}
```

odacli CPU Pool Commands for Bare Metal and KVM

Use odacli commands to manage resource allocations on Oracle Database Appliance for bare metal and KVM deployments.

CPU pools enable management of CPU resources in both bare metal and KVM environments. There are two types of CPU pools, that is, BM and VM.

Use the BM CPU pool to ensure that the database on a bare metal host runs exclusively on the CPUs specified in the CPU pool.

Use the VM CPU pools to cage and manage CPU resource allocations to workloads for virtual machines. Workloads are isolated by creating CPU pools and assigning or pinning virtual machines to a specific CPU pool. When you pin a virtual machine to a CPU pool, you ensure that the virtual machine uses CPUs in only that CPU pool.

Resources in CPU pools cannot overlap, that is, CPU pools cannot share CPUs.

- [odacli create-cpupool](#)
Use the `odacli create-cpupool` command to create a new CPU pool on Oracle Database Appliance Bare Metal or Kernel-based Virtual Machine (KVM) deployment.
- [odacli list-cpupools](#)
Use the `odacli list-cpupools` command to list all CPU Pools on Oracle Database Appliance Bare Metal or Kernel-based Virtual Machine (KVM) deployment.
- [odacli describe-cpupool](#)
Use the `odacli describe-cpupool` command to describe CPU Pools on Oracle Database Appliance Bare Metal or Kernel-based Virtual Machine (KVM) deployment.

- [odacli modify-cpupool](#)
Use the `odacli modify-cpupool` command to modify a CPU Pool configuration on Oracle Database Appliance Bare Metal or Kernel-based Virtual Machine (KVM) deployment.
- [odacli delete-cpupool](#)
Use the `odacli delete-cpupool` command to delete a CPU Pool configuration on Oracle Database Appliance Kernel-based Virtual Machine (KVM).
- [odacli list-auditrecords](#)
Use the `odacli list-auditrecords` command to list the audit records for a CPU Pool on Oracle Database Appliance Bare Metal or Kernel-based Virtual Machine (KVM) deployment.
- [odacli describe-auditrecord](#)
Use the `odacli describe-auditrecord` command to describe the audit record for a CPU Pool on Oracle Database Appliance Bare Metal or Kernel-based Virtual Machine (KVM) deployment.

odacli create-cpupool

Use the `odacli create-cpupool` command to create a new CPU pool on Oracle Database Appliance Bare Metal or Kernel-based Virtual Machine (KVM) deployment.

Syntax

```
odacli create-cpupool -n name -c {-bm|-vm} -nn node_name [-j] [-h]
```

Parameters

Parameter	Description
<code>--name, -n</code>	Specifies the CPU Pool name.
<code>--cores, -c</code>	Specifies the CPU Pool cores
<code>--bm, -bm</code>	Specifies the CPU Pool as Bare Metal
<code>--vm, -vm</code>	Specifies the CPU Pool as Virtual Machine.
<code>--node-name, -nn</code>	(Optional) Specifies the node where the CPU Pool will be created. On High-Availability deployment, if this option is not specified, then the CPU pool is created on both nodes.
<code>--json, -j</code>	(Optional) Displays output in JSON format.
<code>--help, -h</code>	(Optional) Displays help for using the command.

Usage Notes

- Attach the BM CPU pool to databases. Bare metal CPU pools can be assigned to multiple databases.
- Attach VM CPU pool VM guest machines. VM CPU pools can be assigned to multiple VMs.
- Resources in CPU pools cannot overlap, that is, CPU pools cannot share CPUs.
- After you create a BM CPU pool, you can associate this CPU pool to a database using the `create-database` or `modify-database` command.

- After you create a VM CPU pool, you can associate this CPU pool to a VM using the `create-vm` or `modify-vm` command.
- Number of cores must be an even number between 2 and the total number of available cores on the system.

Example

Create a BM CPU pool named `cpupool1` with 6 cores associated to it.

```
# odacli create-cpupool -n cpupool1 -c 6 -bm
```

Create a VM CPU pool named `cpupool2` with 6 cores associated to it.

```
# odacli create-cpupool -n cpupool2 -c 6 -vm
```

odacli list-cpupools

Use the `odacli list-cpupools` command to list all CPU Pools on Oracle Database Appliance Bare Metal or Kernel-based Virtual Machine (KVM) deployment.

Syntax

```
odacli list-cpupools [-j] [-h]
```

Parameters

Parameter	Description
<code>--json, -j</code>	(Optional) Displays output in JSON format.
<code>--help, -h</code>	(Optional) Displays help for using the command.

Example

```
# odacli list-cpupools
```

odacli describe-cpupool

Use the `odacli describe-cpupool` command to describe CPU Pools on Oracle Database Appliance Bare Metal or Kernel-based Virtual Machine (KVM) deployment.

Syntax

```
odacli describe-cpupool -n name [-j] [-h]
```

Parameters

Parameter	Description
<code>--name, -n</code>	Specifies the name of the CPU Pool.
<code>--json, -j</code>	(Optional) Displays output in JSON format.
<code>--help, -h</code>	(Optional) Displays help for using the command.

Example: Describing a CPU pool named cpupool1

```
# odacli describe-cpupool -n cpupool1
```

odacli modify-cpupool

Use the `odacli modify-cpupool` command to modify a CPU Pool configuration on Oracle Database Appliance Bare Metal or Kernel-based Virtual Machine (KVM) deployment.

Syntax

```
odacli modify-cpupool -n name -c cores -f -l [-j] [-h]
```

Parameters

Parameter	Description
<code>--name, -n</code>	Specifies the CPU Pool name
<code>--cores, -c</code>	Specifies the new number of CPU cores
<code>--force, -f</code>	(Optional) Forces the operation
<code>--live, -l</code>	(Optional) Applies the changes to running VMs
<code>--json, -j</code>	(Optional) Displays output in JSON format.
<code>--help, -h</code>	(Optional) Displays help for using the command.

Usage Notes

For VM CPU pool, if `--live` is not specified, then the changes are applied to the VM configuration file and will be activated next time the VM is started. If `--live` is specified, then the changes will be applied to both VM configuration file and to the running VM.

Example

Set the size of a CPU Pool `cpupool1` to 10. If `--live` is not specified, the change is applied to the VM configuration file and will be activated next time the VM is started.

```
# odacli modify-cpupool -n cpupool1 -c 10
```

odacli delete-cpupool

Use the `odacli delete-cpupool` command to delete a CPU Pool configuration on Oracle Database Appliance Kernel-based Virtual Machine (KVM).

Syntax

```
odacli delete-cpupool -n name -f [-j] [-h]
```

Parameters

Parameter	Description
<code>--name, -n</code>	Specifies the CPU Pool name to be deleted

Parameter	Description
<code>--force, -f</code>	(Optional) Forces deletion.
<code>--json, -j</code>	(Optional) Displays output in JSON format.
<code>--help, -h</code>	(Optional) Displays help for using the command.

Example

Delete a CPU pool named `cpupool1`.

```
# odacli delete-cpupool -n cpupool1
```

odacli list-auditrecords

Use the `odacli list-auditrecords` command to list the audit records for a CPU Pool on Oracle Database Appliance Bare Metal or Kernel-based Virtual Machine (KVM) deployment.

Syntax

```
odacli list-auditrecords -du dcs-username -f from_date-range -l latest -n
node_ID -ot operation_type -ou OS_username -rn resource_name -rt resource_type
-t to_date-range [-j] [-h]
```

Parameters

Parameter	Description
<code>--dcs-user, -du</code>	(Optional) Specifies the DCS user name.
<code>--from, -f</code>	(Optional) Specifies the <i>from</i> date in the date range for the CPU pool audit records.
<code>--latest, -l</code>	(Optional) Specifies the latest number of CPU pool audit records.
<code>--node-id, -n</code>	(Optional) Specifies the node ID.
<code>--op-type, -ot</code>	(Optional) Specifies the type of operation.
<code>--os-user, -ou</code>	(Optional) Specifies the operating system user.
<code>--rsc-name, -rn</code>	(Optional) Specifies the resource name.
<code>--rsc-type, -rt</code>	(Optional) Specifies the resource type.
<code>--to, -t</code>	(Optional) Specifies the <i>to</i> date in the date range for the CPU pool audit records.
<code>--json, -j</code>	(Optional) Displays output in JSON format.
<code>--help, -h</code>	(Optional) Displays help for using the command.

Example

```
# odacli list-auditrecords
ID                               Resource type      Resource
name      Operation type  DCS username      OS username
Timestamp
-----
41295d99-f263-4284-b6d9-2aff1ae0f850  BM_CPU_POOL
```

```

testbmpool          CREATE          oda-admin          root
2020-10-08 13:27:05 UTC
0f07a013-5bb4-4cd8-bd49-04dc61fcd454 BM_CPU_POOL
pool_9f74a8e9-      DELETE          oda-admin          root
2020-10-08 12:26:30 UTC
d858269b-6c28-4bc2-af71-79004f3561e6 BM_CPU_POOL
pool_9f74a8e9-      CREATE          oda-admin          root
2020-10-08 12:24:36 UTC
9d7852c1-93fb-410e-9e0c-8c0a95ed3f0c VM_CPU_POOL
pool_d48e81e4-      DELETE          oda-admin          root
2020-10-08 12:06:45 UTC
0235cc84-9345-40bc-ac4f-7de3f63202e2 VM_CPU_POOL
pool_4fe0b4f4-      DELETE          oda-admin          root
2020-10-08 12:06:45 UTC
762f7263-7bd9-4b12-b891-48305165bf36 VM_CPU_POOL
pool_4fe0b4f4-      MODIFY          oda-admin          root
2020-10-08 12:06:22 UTC
0bd2a25d-2327-4918-bd47-8c00f7406f92 VM_CPU_POOL
pool_4fe0b4f4-      MODIFY

```

odacli describe-auditrecord

Use the `odacli describe-auditrecord` command to describe the audit record for a CPU Pool on Oracle Database Appliance Bare Metal or Kernel-based Virtual Machine (KVM) deployment.

Syntax

```
odacli describe-auditrecord -i [-j] [-h]
```

Parameters

Parameter	Description
--id, -i	Describes the ID of the audit record.
--json, -j	(Optional) Displays output in JSON format.
--help, -h	(Optional) Displays help for using the command.

Example

```
# odacli describe-auditrecord -i 41295d99-f263-4284-b6d9-2aff1ae0f850
Audit Record details
```

```
-----
Event details
```

```
-----
Record ID: 41295d99-f263-4284-b6d9-2aff1ae0f850
Record timestamp: 2020-10-08 13:27:05 UTC
DCS username: oda-admin
OS username: root
Cluster ID: test_cluster-c
Node ID: test_cluster
```

```
Resource/Operation
```

```
-----
Resource type: BM_CPU_POOL
Resource ID: b17cb623-bf79-491f-86d8-d8502987e26c
Resource name: testbmpool
Operation type: CREATE
```

Operation description: Created with '2' cores and allocation
'test_cluster:1-2,17-18'

odacli Database Commands

Use the `odacli` database commands to perform database lifecycle operations.

- [odacli clone-database](#)
Use the `odacli clone-database` command to clone a new database from a source database.
- [odacli create-database](#)
Use the `odacli create-database` command to create a new database.
- [odacli delete-database](#)
Use the `odacli delete-database` command to delete a database.
- [odacli describe-database](#)
Use the `odacli describe-database` command to display database details.
- [odacli list-databases](#)
Use the `odacli list-databases` command to list all databases on the appliance.
- [odacli modify-database](#)
Use the `odacli modify-database` command to modify the configuration of a database, such as backup configuration, database class, and database type.
- [odacli move-database](#)
Use the command `odacli move-database` to move a database from one Oracle home to another home of the same database version.
- [odacli register-database](#)
Use the `odacli register-database` command to register a migrated database with the appliance.
- [odacli upgrade-database](#)
You can the `odacli upgrade-database` command to upgrade a database from a supported release. This command is deprecated and will be desupported in a future release. Instead, use the command `odacli move-database` to move databases from one Oracle Database home to another.

odacli clone-database

Use the `odacli clone-database` command to clone a new database from a source database.

File Path

```
/opt/oracle/dcs/bin/odacli
```

Syntax

```
odacli clone-database [-u] [-n] [-s] [-t] [-j] [-f] [-nn] [-p] [-h]  
[-sh|-no-sh]
```

Parameters

Parameter	Description
--databaseUniqueName, -u	(Optional) Defines a unique name for the database. If the --databaseUniqueName option is not provided, then the name of the database is set to the --dbname value.
--dbname, -n	Defines the name given to the new database (dbname.)
--dbshape, -s	Identifies the database shape (template) and determines the total memory allocated to the database. For example, odb1 and odb2. The default is odb1.
--dbtype, -t [SI]	Defines the database type. The default database type is the source database type, if the option is not specified.
--help, -h	(Optional) Displays help for using the command.
--json, -j	(Optional) Displays JSON output.
--sourcedbname, -f	Specifies the name of the source database
--associated-networks, -nn	(Optional) Specifies the associated network names (in the format networkName1,networkName2,...).
--disable-seha, -no-sh	(Optional) Specifies whether you want to disable Standard Edition High-Availability for Oracle Database Standard Edition 19c and later single-instance databases.
--enable-seha, -sh	(Optional) Specifies whether you want to enable Standard Edition High-Availability for Oracle Database Standard Edition 19c and later single-instance databases.
--cpupool, -cp	(Optional) Specifies the CPU pool name.
--tdepassword, -p	(Optional) Specifies the TDE password of the source database.

Usage Notes

- The source database must be up and running.
- The source database must use Oracle ACFS storage.
- The source database must not be a multitenant container database (CDB)
- If -cp parameter is provided as part of the command, cloned database is associated with the particular CPU pool.
- If -cp parameter is not provided as part of the command, and if the parent database has an associated CPU pool, then the cloned database is also associated with the same CPU pool as that of parent database.
- If -cp parameter is not provided as part of the command, and if the parent database does not have any associated CPU pool, then the cloned database is also not associated with any CPU pool.

Example 14-96 Cloning a Database

The following example creates a clone database snap1 from source database acfsdb1.

```
# /opt/oracle/dcs/bin/odacli clone-database -n snap1 -u snaplu -f
acfsdb1
```

Example 14-97 Cloning a Database and associating it with the same CPU Pool as the parent database

```
# odacli clone-database -f dbcpupin -n dbclone -u dbcloneUnique
Enter new 'SYS user' password:
Confirm 'SYS user' password:
{
  "jobId" : "74a80586-3523-4367-93a0-38401647c5a0",
  "status" : "Created",
  "message" : null,
  "reports" : [ ],
  "createTimestamp" : "August 09, 2020 10:25:40 AM UTC",
  "resourceList" : [ ],
  "description" : "Snap Database service creation with db name:
dbclone",
  "updatedAtTime" : "August 09, 2020 10:25:40 AM UTC"
}
```

Example 14-98 Cloning a Database and associating it with a different CPU Pool

```
# odacli clone-database -f dbcpupin -n dbclone -u dbcloneUnique -cp
testdbcpupool2
Enter new 'SYS user' password:
Confirm 'SYS user' password:
{
  "jobId" : "2fe285b5-2e3b-4e80-9121-e7c8380952b3",
  "status" : "Created",
  "message" : null,
  "reports" : [ ],
  "createTimestamp" : "August 09, 2020 10:36:55 AM UTC",
  "resourceList" : [ ],
  "description" : "Snap Database service creation with db name:
dbclone",
  "updatedAtTime" : "August 09, 2020 10:36:55 AM UTC"
}
```

Example 14-99 Cloning a TDE-Enabled Database

```
# odacli clone-database -n tdbc -u tdbc -f tdb -p
Enter new 'SYS user' password:
Confirm 'SYS user' password:
Enter new 'TDE Wallet' password:
Confirm 'TDE Wallet' password:
```

Related Topics

- [Cloning an Oracle ACFS Database Using Command Line Interface](#)
Create a database from an existing Oracle ACFS database using CLI commands.

odacli create-database

Use the `odacli create-database` command to create a new database.

File Path

`/opt/oracle/dcs/bin/odacli`

Syntax

```
odacli create-database -n database_name -cs characterset -cl {OLTP|DSS|
IMDB}
-l dblanguage -s dbshape -r {ACFS|ASM} -dt dbterritory
-y dbtype -ns nationalscharacterset -d pdbadmin -p pdbname -v version
[-u databaseUniqueName] [-dh Database Home ID] [-c|-no-c] [-co|-no-co]
[-bi backupconfigid] [-io] [-dn] [-j] [-nn] [-h] [-rd] [-sh|-no-sh]
[-t] [-cp]
```

Parameters

Parameter	Description
<code>--backupconfigid, -bi</code>	(Optional) Defines the backup configuration identifier for future use.
<code>--cdb, -c</code>	(Optional) Creates the database as a container database. Use the <code>-c</code> flag to create a container database and use the <code>-no-c</code> flag to create a non-CDB database. The default is <code>-no-c</code> .
<code>--characterset, -cs</code>	Defines the character set. The default is AL32UTF8.
<code>--databaseUniqueName, -u</code>	(Optional) Defines a unique name for the database.
<code>--dbdomainname, -dn</code>	Defines the database domain name.
<code>--cpupool, -cp</code>	Defines the CPU pool name. The CPU pool must be of type bare metal (BM).
<code>--dbEdition, -de</code>	Defines the Database Edition.
<code>--dbclass, -cl {OLTP DSS IMDB}</code>	Defines the database class. The default is OLTP. The options are as follows: <ul style="list-style-type: none"> • Enterprise Edition: OLTP, DSS, or IMDB. • Standard Edition: OLTP
<code>--dbconsole, -co</code>	(Optional) Enables the Database Console. Use the <code>-no-co</code> flag to disable the Database Console. If not selected, the default is no database console.
<code>--dbhomeid, -dh</code>	(Optional) Identifies the existing Database Home ID.
<code>--dblanguage, -l</code>	Defines the database language. The default language is AMERICAN.
<code>--dbname, -n</code>	Defines the name given to the new database (<code>dbname</code> .)

Parameter	Description
--dbshape, -s	Identifies the database shape (template) and determines the total memory allocated to the database. For example, odb1 and odb2. The default is odb1. You cannot specify the database shape when you create a instance-only database.
--dbstorage, -r{ACFS ASM}	Defines the Database Storage, either Oracle ACFS or Oracle ASM. The default value is Oracle ASM.
--dbterritory, -dt	Defines the database territory. The default territory is AMERICA.
--dbtype, -y [SI]	Defines the database type. The default database type is SI.
--help, -h	(Optional) Displays help for using the command.
--instanceonly, -io	(Optional) Creates a database instance, password file and also the underlying Oracle ACFS mount point. You can use the instance as an auxiliary instance for RMAN duplicate.
--json, -j	(Optional) Displays JSON output.
--nationalscharacterst, -ns	Defines the NLS National Character Set. The default is AL16UTF16.
--no-cdb, -no-c	(Optional) Creates a database that is <i>not</i> a container database. Use this flag when you want to create a non-CDB database. Use the -c flag to create a container database.
--no-dbconsole, -no-co	(Optional) Disables Database Console. Use the -co flag to enable Database Console.
--pdbadmin, -d	Defines the Pluggable Database (PDB) Admin User.
--pdbname, -p	Defines the Pluggable Database (PDB) name. The default value is pdb1.
--version, -v	Defines the database bundle patch number. To install the latest bundle patch for a release, specify the release version. To specify a specific supported bundle, use the 5 digit format. For example, 12.1.0.2.170814 or 11.2.0.4.170814.
--dbRedundancy, -rd	Specifies the database redundancy value, that is, {HIGH MIRROR}. To specify the dbRedundancy option for an Oracle ASM or ACFS storage-based database, at least one disk group of FLEX redundancy must exist. To specify the dbRedundancy option for an Oracle ASM storage database, the dbVersion or dbHomeVersion must be 12.2 or later.
--associated-networks, -nn	Specifies the associated network names (in the format networkName1,networkName2,...).
--enable-tde, -t	Specifies whether to enable Transparent Data Encryption (TDE) which uses Software Keystore.
--disable-seha, -no-sh	Specifies whether you want to disable Standard Edition High-Availability for Oracle Database Standard Edition 19c and later single-instance databases.
--enable-seha, -sh	Specifies whether you want to enable Standard Edition High-Availability for Oracle Database Standard Edition 19c and later single-instance databases.

Parameter	Description
--targethost, -th	(Optional) Specifies the target host name (applicable only for Oracle RAC One Node Database and Standard Edition High Availability single-instance Oracle Database 19c and later).
--targetnode, -g	(Optional) Specifies the target node number (applicable only for Oracle RAC One Node database and Standard Edition High Availability single-instance Oracle Database 19c and later). The values are 0 or 1.
--levelzerobackupday, -lb	(Optional) Specifies the level zero backup day. The values can be Monday Tuesday Wednesday... Sunday. The default is Sunday.
--backupconfigname, -bn	(Optional) Specifies the name of the backup configuration.
--bkuppassword, -bp	(Optional) Specifies the RMAN backup encryption password.
--enableFlashCache, -fc	(Optional) Specifies whether to enable Flash Cache.
--no-enableFlashCache, -no-fc	(Optional) Specifies whether to disable Flash Cache.
--dbOnFlashStorage, -f	(Optional) Specifies whether to enable data on Flash storage.
--no-dbOnFlashStorage, -no-f	(Optional) Specifies whether to disable data on Flash storage.

Usage Notes

- If the disk group redundancy is FLEX, then the default dbRedundancy value is MIRROR.
- Flash cache is disabled by default.
- You cannot mix Oracle Database Standard Edition and Enterprise Edition databases on the same appliance.
- For Standard Edition Oracle Database 19c or later, you cannot create Oracle RAC Or Oracle RAC One Node Database. For Standard Edition, you can only deploy single-instance Oracle Database with or without high-availability enabled.
- Transparent Data Encryption (TDE) is an Advanced Security Option (ASO) available with Oracle Database Enterprise Edition.
- TDE is not configured by default during database creation.
- The dbname and databaseUniqueName can contain underscores (-), lowercase and uppercase alphabet (a-zA-Z, and numeric characters (0-9), must start with an alphabet, and must not exceed 8 characters in length. The dbname and databaseUniqueName must not also be an Oracle reserved key word.
- Use the --cdb or --no-cdb flag to indicate whether or not the database is a container database. When neither flag is specified, the default database created is a non-CDB database.
- When --dbhomeid is not provided, the create-database command creates a new Oracle Database Home.

- When `--dbhomeid` is provided, the `create-database` command creates the database using the existing Oracle Home. Use the `odacli list-dbhomes` command to obtain the `dbhomeid`.
- When you use the command to create an instance-only database, then you cannot specify the database shape (template).
- When you specify both the `--version` and the `--dbhomeid`, the version is ignored and the database is created against the existing database home.
- Oracle Database 12.1 or later is supported on both Oracle Automatic Storage Management (Oracle ASM) and Oracle ASM Cluster file system (ACFS). The default is Oracle ASM.
- Oracle Database 11.2 is only supported on Oracle ACFS.
- When databases are created in Oracle ACFS, each database is configured with its own Oracle ACFS file system for the datafiles and uses the following naming convention: `/u02/app/db user/oradata/db unique name`. The default size of this mount point is 100 GB.

 **Note:**

Oracle recommends not sharing the mount point across different databases.

- Online logs are stored in the `/u03/app/db user/redo/` directory.
- Oracle Fast Recovery Area (FRA) is located in the `/u03/app/db user/fast_recovery_area` directory.
- For the version, you can specify the database version, for example, 18.8.0.0, 12.2.0.1, 12.1.0.2 or 11.2.0.4, or you can use a 5 digit format to specify a specific patch bundle version. If you use the database version without specifying the bundle patch number, the latest bundle patch is used.

 **Note:**

Oracle Database 11.2.0.4.160419 is not supported. Attempts to create an Oracle Database 11.2 against an 11.2.0.4.160419 database home will fail.

 **Caution:**

When you create a database with Transparent Data Encryption (TDE) enabled, you are prompted to set a password for the TDE wallet. Provide a strong password for security compliance. Set the password carefully, and ensure that this password is available to you at all times for database management operations. Failure to provide the TDE wallet password when prompted, will cause an error in accessing encrypted data.

Example 14-100 Creating a TDE-enabled database

```
# odacli create-database -n test -t
Enter new 'SYS, SYSTEM and PDB Admin user' password:
Confirm 'SYS, SYSTEM and PDB Admin user' password:
Enter new 'TDE wallet' password:
Confirm 'TDE wallet' password:
```

Example 14-101 Creating a Database in Interactive Mode

This example creates a 19.10.0.0.0 OLTP container database named `hrdb` with shape `odb2` and enables you to provide the password interactively.

```
# odacli create-database -n hrdb -c -cl OLTP -s odb2 -p pdb1

Enter new 'SYS, SYSTEM and PDB Admin user' password:
Confirm 'SYS, SYSTEM and PDB Admin user' password:
{
  "jobId" : "f12485f2-dcbe-4ddf-aeel-de24d37037b6",
  "status" : "Created",
  "message" : null,
  "reports" : [ ],
  "createTimestamp" : "January 8, 2021 03:54:03 AM EDT",
  "description" : "Database service creation with db name: hrdb",
  "updatedAtTime" : "January 8, 2021 03:54:03 AM EDT"
}
```

Example 14-102 Creating a Database Against a Different Version

Either of the following statements creates a database against a home with Oracle Database Bundle applied:

```
# odacli create-database -n hrmsdb1 -v 19.10.0.0.0
# odacli create-database -n hrmsdb2 -v 19.10.0.0.210119
```

The following statement creates a new database against a home with a specific Oracle Database Bundle:

```
# odacli create-database -n hrmsdb3 -v 19.10.0.0.210119
```

Example 14-103 Creating a Database associated with a CPU Pool

The following command creates a new database associated with a CPU pool:

```
# odacli create-database -j -n dbcpupl -r ACFS -cp testdbcpupool
```

odacli delete-database

Use the `odacli delete-database` command to delete a database.

File Path

```
/opt/oracle/dcs/bin/odacli
```

Syntax

To delete a database:

```
odacli delete-database -i dbid [-h] [-j] [-fd]
```

Parameters

Parameter	Description
<code>--dbid, -i</code>	Identifies the database home identifier (ID) to display. Use the <code>odacli list-databases</code> command to obtain the <code>--dbid</code> .
<code>--force, -fd</code>	(Optional) Forces the delete operation.
<code>--help, -h</code>	(Optional) Displays help for using the command.
<code>--json, -j</code>	(Optional) Displays JSON output.

Usage



Note:

The `odacli delete-database` command deletes the database, the file system, and the underlying `advn` volumes assigned to the database. For example, deleting a database named `hrpdb` also deletes the file system `/u02/app/oracle/oradata/hrpdb`. Do not keep any other files on this database file location. If you have manually added static entries for the database you want to delete in your `listener.ora` file, then remove these entries before running the `odacli delete-database` command.

Example 14-104 Deleting a Database Named `hrmsdb`

In this example we want to delete a database named `hrmsdb`. Before we can delete the database, we need to know the database home identifier (`dbid`). This example shows how to run the `odacli list-databases` command to list the databases and their associated `dbid`, then how to delete database `hrmsdb`.

```
# odacli list-databases
```

```
ID                               DB Name  DB Version  CDB
Class
-----
```

```
a3f4a6c0-a0c9-4c79-bad7-898afcf9de46  hrmsdb  12.1.0.2  true  OLTP
7e28bf52-1a09-49fd-9391-841838d2c42f  crmdb  12.1.0.2  false OLTP
```

(continued)

```
Shape      Storage  Status
-----
odbl       ACFS     Configured
odbl       ACFS     Configured
```

```
# odacli delete-database -i a3f4a6c0-a0c9-4c79-bad7-898afcf9de46
```

odacli describe-database

Use the `odacli describe-database` command to display database details.

File Path

```
$ORACLE_HOME/opt/oracle/dcs/bin/odacli
```

Syntax

To display database details:

```
odacli describe-database -i dbid [-h] [-j]
```

Parameters

Parameter	Description
--dbid, -i	Identifies the database home identifier (ID) to display. Use the <code>odacli list-databases</code> command to obtain the dbid.
--json, -j	(Optional) Displays JSON output.
--help, -h	(Optional) Displays help for using the command.

Example 14-105

Display information for a database.

```
# odacli describe-database -i odacn
```

Database details

```
-----
ID: 896238139
Description: odacn
DB Name: odacn
DB Version: 19.6.0.0.200114
DB Type: Si
DB Role: PRIMARY
DB Target Node Name: node1
DB Edition: EE
DBID: 896238139
```

```

Instance Only Database: false
      CDB: false
      PDB Name:
PDB Admin User Name:
      SEHA Enabled: false
      Class: Oltp
      Shape: Odb1
      Storage: Asm
      DB Redundancy: MIRROR
      CharacterSet: AL32UTF8
National CharacterSet: AL16UTF16
      Language: AMERICAN
      Territory: AMERICA
      Home ID: bcc3991a-0ffc-4d29-86ae-40f2b8721dc4
      Console Enabled: false
      Level 0 Backup Day: Sunday
      AutoBackup Enabled: true
      Created: March 30, 2020 9:33:09 AM PDT
      DB Domain Name: domain.com
      Associated Networks: Public-network

```

Example 14-106 Displaying Database Details

Display information for database named ac48e0d2-a7b0-4ffd-a27e-f8e42b028c5f :

```

# odacli describe-database -i ac48e0d2-a7b0-4ffd-a27e-f8e42b028c5f

Database details
-----
ID: ac48e0d2-a7b0-4ffd-a27e-f8e42b028c5f
Description: rdb1
DB Name: rdb1
DB Version: 19.10.0.0.0
DBID: 1339792271
CDB: true
PDB Name: rlpdb1
PDB Admin User Name: pdbadmin
Class: OLTP
Shape: odb2
Storage: ASM
CharacterSet: DbCharacterSet(characterSet=AL32UTF8,
nlsCharacterSet=AL16UTF16, dbTerritory=AMERICA, dbLanguage=AMERICAN)
Home ID: fe87f30c-b810-45d1-8b96-13996ad7a255
Console Enabled: true
Created: January 8, 2021, 2016 6:21:14 PM

```

odacli list-databases

Use the `odacli list-databases` command to list all databases on the appliance.

File Path

```
$ORACLE_HOME/opt/oracle/dcs/bin/odacli
```

Syntax

To display a list of all databases:

```
odacli list-databases [-h]
```

Parameters

Parameter	Description
--help, -h	(Optional) Displays help for using the command.

Example 14-107 Displaying a List of Databases

Display a list of databases:

```
# odacli list-databases
```

```

ID                                     DB Name    DB Version  CDB
-----
ad6c7326-e460-411e-94df-230dedbef743  rdb121a    19.10.0.0.0  true
fb4d02f3-2413-47ca-8584-a768e23ec2e7  ee12db     19.10.0.0.0  false

```

(Continued)

```

Class   Shape  Storage  Status
-----
OLTP    odb1   ACFS     Configured
IMDB    odb1   ASM      Configured

```

odacli modify-database

Use the `odacli modify-database` command to modify the configuration of a database, such as backup configuration, database class, and database type.

File Path

```
/opt/oracle/dcs/bin/odacli
```

Syntax

```
odacli modify-database [-i] [-dn] [-no-sh] [-sh] [-lb] [-nobkp] [-th]
[-g] [-cl] [-rd] [-s] [-an] [-bi] [-bin] [noab] [-bp] [-id] [-in] [-y]
[-cp] [-no-cpupool] [-rkt] [-ctp] [-h] [-j]
```

Parameters

Parameter	Description
--databaseid, -id	Defines the database identifier.
--dbName, -in	Defines the database name to be updated. Specify either --dbName or --dbid.

Parameter	Description
--dbid, -i	Defines the database ID to be updated. Specify either --dbName or --dbid.
--dbRedundancy, -rd	(Optional) Specifies the database redundancy value, that is, {HIGH MIRROR}. To specify the dbRedundancy option for an Oracle ASM or ACFS storage-based database, at least one disk group of FLEX redundancy must exist. To specify the dbRedundancy option for an Oracle ASM storage database, the dbVersion or dbHomeVersion must be 12.2 or later.
--levelzerobackupday, -lb	(Optional) Specifies the Level zero Backup Day. For example, Monday Tuesday Wednesday... Sunday
--backupconfigid, -bi	(Optional) Defines the backup configuration identifier for future use.
--backupconfigname, -bin	(Optional) Specifies the name of the backup configuration.
--bkuppassword, -bp	(Optional) Specifies the RMAN backup encryption password.
--no-autobackup, -noab	(Optional) Disables automatic database backups.
--no-backup, -nobkp	(Optional) Disables database backups. Specify this option to also remove the database backup and archivelog backup schedulers. To enable database backups again, you must update the database with a backupconfig object.
--dbclass, -cl	(Optional) Defines the database class. The default is OLTP. The options are OLTP, DSS, or IMDB.
--dbshape, -s	(Optional) Identifies the database shape (template) and determines the total memory allocated to the database. For example, odb1 and odb2. The default is odb1. You cannot specify the database shape for an instance-only database.
--attachnetworks, -an	(Optional) Specifies the name of the networks to be attached. Specify the networks in the format <i>network_name1, network_name1, network_name1</i> .
--detachnetworks, -dn	(Optional) Specifies the name of the networks to be detached. Specify the networks in the format <i>network_name1, network_name1, network_name1</i> .
--dbtype, -y	Defines new database type. The only option is SI.
--disable-seha, -no-sh	Disables Standard Edition High Availability for single-instance Oracle Database 19c and later.
--enable-seha, -sh	Enables Standard Edition High Availability for single-instance Oracle Database 19c and later.
--targethost, -th	(Optional) Specifies the target host name (applicable only for Oracle RAC One Node Database and Standard Edition High Availability single-instance Oracle Database 19c and later).

Parameter	Description
<code>--targetnode, -g</code>	(Optional) Specifies the target node number (applicable only for Oracle RAC One Node database and Standard Edition High Availability single-instance Oracle Database 19c and later). The values are 0 or 1.
<code>--cpupool, -cp</code>	(Optional) Specifies the CPU pool name. Use this option to associate a CPU pool to a database that does not use any CPU pool or to change the existing association of a CPU pool to a new CPU pool for a database.
<code>--no-cpupool</code>	(Optional) Removes the attached CPU pool.
<code>--change-tde-password, -ctp</code>	(Optional) When specified, you are prompted for the current and new TDE Wallet password.
<code>--rekey-tde, -rkt</code>	(Optional) When specified, current TDE Wallet password is prompted to rekey the TDE master encryption key.
<code>--help, -h</code>	(Optional) Displays help for using the command.
<code>--json, -j</code>	(Optional) Displays JSON output.

Usage Notes

▲ Caution:

When you change the TDE wallet password for a database with Transparent Data Encryption (TDE) enabled, you are prompted to set a password for the TDE wallet. Provide a strong password for security compliance. Set the password carefully, and ensure that this password is available to you at all times for database management operations. Failure to provide the TDE wallet password when prompted, will cause an error in accessing encrypted data.

Example 14-108 Modifying the Database Shape (Template) and Database Class

```
# odacli modify-database -s database_shape -cl database_class -i dbid
odacli modify-database -i 1941d594-c777-4eca-9fce-18b778d5c153 -s odb2
-cl DSS
{
  "jobId" : "833d43a7-bcc6-48a7-9f98-b42ffdab3fe1",
  "status" : "Created",
  "message" : null,
  "reports" : [ ],
  "createTimestamp" : "August 26, 2019 06:48:58 AM UTC",
  "resourceList" : [ ],
  "description" : "modify-database service with db ids: 1941d594-
c777-4eca-9fce-18b778d5c153",
  "updatedAtTime" : "August 26, 2019 06:48:58 AM UTC"
}
```

Example 14-109 Converting Oracle RAC or Oracle RAC One Node Database to Single-instance Oracle Database

```
# odacli modify-database -in db18 -y SI
For moving a database between homes please use the command 'move-
database'.
{
  "jobId" : "4b548365-dac5-4557-a6a8-2f65c2b725e7",
  "status" : "Created",
  "message" : "Modify database",
  "reports" : [ ],
  "createTimestamp" : "April 21, 2020 00:32:55 AM UTC",
  "resourceList" : [ {
    "resourceId" : "de2a7959-e31b-4dee-b600-6b16dfb78c34",
    "resourceType" : "DB",
    "resourceNewType" : null,
    "jobId" : "4b548365-dac5-4557-a6a8-2f65c2b725e7",
    "updatedAt" : "April 21, 2020 00:32:55 AM UTC"
  } ],
  "description" : "Modify database : db18",
  "updatedAt" : "April 21, 2020 00:32:55 AM UTC"
}
```

Example 14-110 Specifying the target node when converting database

```
# odacli modify-database -in db18 -y SI -g node_number
# odacli modify-database -in db18 -y SI -th node_name
```

Example 14-111 Changing the TDE Wallet Password

```
# odacli modify-database -in testdb -ctp
Enter current 'TDE wallet' password:
Enter new 'TDE wallet' password:
Confirm 'TDE wallet' password:
```

Example 14-112 Re-keying the TDE Master Encryption Password

```
# odacli modify-database -in testdb -rkt
Enter current 'TDE wallet' password:
```

Example 14-113 Removing a CPU pool

```
# odacli modify-database -in dbcpupin -cp testdbcpupool2
DB will be restarted as part of CPU Pool operation. Do you want to
continue [y/n]:y
For moving a database between homes please use the command 'move-
database'.
{
  "jobId" : "c1d05fb3-828a-4644-af9a-9d82b4ef5a89",
  "status" : "Created",
  "message" : "Modify database",
  "reports" : [ ],
```

```

    "createTimestamp" : "August 09, 2020 16:18:54 PM UTC",
    "resourceList" : [ {
      "resourceId" : "ff9c138b-a003-40cf-b1fc-0b33cd955ebf",
      "resourceType" : "DB",
      "resourceNewType" : null,
      "jobId" : "c1d05fb3-828a-4644-af9a-9d82b4ef5a89",
      "updatedAt" : "August 09, 2020 16:18:54 PM UTC"
    } ],
    "description" : "Modify database : dbcpupin",
    "updatedAt" : "August 09, 2020 16:18:54 PM UTC"
  }
}

```

odacli move-database

Use the command `odacli move-database` to move a database from one Oracle home to another home of the same database version.

File Path

```
/opt/oracle/dcs/bin/odacli
```

Syntax

```
odacli move-database [-i dbid] [-in dbname] [-dh dest-dbhome-id][-dhn
dest-dbhome-name][-j] [-h]
```

Parameters

Parameter	Description
<code>--dbid, -i</code>	(Optional) Defines the database ID.
<code>--dbName, -in</code>	(Optional) Defines the database name.
<code>--help, -h</code>	(Optional) Displays help for using the command.
<code>--json, -j</code>	(Optional) Displays JSON output. The default is false.
<code>--dest-db-home-id, -dh</code>	(Optional) Defines the destination database home ID.
<code>--dest-dbhome-name, -dhn</code>	(Optional) Defines the destination database home name.

Usage Notes

Example 14-114 Moving a Database from one Oracle home to another

```
# ./odacli move-database -i database_ID -dh destination_database_home_ID
```

odacli register-database

Use the `odacli register-database` command to register a migrated database with the appliance.

File Path

```
/opt/oracle/dcs/bin/odacli
```

Syntax

```
odacli register-database -c {OLTP|DSS|IMDB} -s dbshape -t dbtypeSI -o hostname -sn servicename [-bi backupconfigid] [-co|-no-co] [-nn] [-h] [-j] [-sh|-no-sh]
```

Parameters

Parameter	Description
<code>--backupconfigid, -bi</code>	(Optional) Defines the backup configuration identifier for future use.
<code>--dbclass, -c {OLTP DSS IMDB}</code>	Defines the database class. The database class setting determines the database SGA memory and instance PGA memory configuration. The options are as follows: <ul style="list-style-type: none"> Enterprise Edition: OLTP, DSS, or IMDB. Standard Edition: OLTP
<code>--dbconsole, -co</code>	(Optional) Enables the Database Console. Use the <code>-no-co</code> flag to disable the Database Console. If not selected, the default is no Database Console.
<code>--dbshape, -s</code>	Identifies the database shape (template) and determines the total memory allocated to the database. For example, <code>odb1</code> and <code>odb2</code> . The default is <code>odb1</code> .
<code>--dbtype, -t [SI]</code>	Defines the type of database. Only single-instance databases can be registered.
<code>--help, -h</code>	(Optional) Displays help for using the command.
<code>--hostname, -o</code>	Defines the host name. Default: local host name
<code>--json, -j</code>	(Optional) Displays JSON output.
<code>--no-dbconsole, -no-co</code>	(Optional) Disables Database Console. Use the <code>-co</code> flag to enable Database Console.
<code>--servicename, -sn</code>	Defines the Database Service Name. Using this service name, the EZCONNECT String is derived for connecting to the database. For example, <code>hostname:port/servicename</code> . The Port number is the port configured for the listener, as part of the deployment.

Parameter	Description
<code>--associated-networks, -nn</code>	Specifies the associated network names (in the format <code>networkName1,networkName2,...</code>).
<code>--disable-seha, -no-sh</code>	Specifies whether you want to disable Standard Edition High-Availability for Oracle Database Standard Edition 19c and later single-instance databases.
<code>--enable-seha, -sh</code>	Specifies whether you want to enable Standard Edition High-Availability for Oracle Database Standard Edition 19c and later single-instance databases.

Usage Notes

Note:

It is a good practice to use Easy Connect (EZCONNECT) to test the database connectivity before registering the database.

Log in as the `sys` user and enter the following command:

```
sqlplus sys/password@//hostname:1521/service name
```

- The `odacli register-database` command is supported only on the primary database.
- The migrated database is registered with the listener configured during the provisioning of the appliance. The migrated database must be in read-write or read-only mode for the registration to succeed.
- The `register-database` command validates the `datafile` and `log file` locations and moves the `controlfile` and `spfile` to the correct locations.
- The following are the minimum compatible parameters set, based on the database version:
 - Oracle Database 18c : 18.3.0.0
 - Oracle Database 12c : 12.1.0.2
 - Oracle Database 11 g : 11.2.0.4
- Some `init.ora` parameters are set, or reset, as part of the registration. Review the parameter changes before and after registration.

The following are examples of changes implemented as part of registration:

- The `memory_target` is reset.
- The `sga_target/pga_aggregate_target/log_buffer/inmemory_size` is configured based on the database class and database shape settings used during registration.
- The registration process sets, or resets, the recommended appliance-specific parameters.

- The database being registered must use Oracle Managed Files and the file location must match the DATA Location, REDO Location and RECO Location of the `odacli describe-dbstorage` command.
- As part of the registration process, the database is registered with Oracle Clusterware. Only the primary database is registered with Oracle Clusterware.

Example 14-115 Registering a Migrated Database

The following is the syntax to register a single instance OLTP database that is using shape `odbl`.

```
odacli register-database -c OLTP -s odbl -sn crmdb.example.com
Enter new 'SYS user' password:
Confirm 'SYS user' password:
{
  "jobId" : "317b430f-ad5f-42ae-bb07-13f053d266e2",
  "status" : "Created",
  "message" : null,
  "reports" : [ ],
  "createTimestamp" : "January 8, 2021 05:55:49 AM EDT",
  "description" : "Database service registration with db service name:
crmdb.example.com",
  "updatedAt" : "January 8, 2021 05:55:49 AM EDT"
}
rpandrap: ]# odacli describe-job -i "317b430f-ad5f-42ae-
bb07-13f053d266e2"
```

Job details

```
-----
                        ID: 317b430f-ad5f-42ae-bb07-13f053d266e2
Description: Database service registration with db service
name: crmdb.example.com
Status: Success
Created: January 8, 2021 5:55:49 AM EDT
Message:
```

Task Name	Start Time
restore control file	January 8, 2021 5:55:49 AM EDT
move spfile to right location	January 8, 2021 5:56:08 AM EDT
register DB with clusterware	January 8, 2021 5:56:13 AM EDT
reset db parameters	January 8, 2021 5:57:05 AM EDT
Running DataPatch	January 8, 2021 5:57:36 AM EDT

(Continued)

End Time	Status
January 8, 2021 5:56:08 AM EDT	Success
January 8, 2021 5:56:13 AM EDT	Success
January 8, 2021 5:57:05 AM EDT	Success
January 8, 2021 5:57:36 AM EDT	Success
January 8, 2021 5:57:49 AM EDT	Success

odacli upgrade-database

You can use the `odacli upgrade-database` command to upgrade a database from a supported release. This command is deprecated and will be desupported in a future release. Instead, use the command `odacli move-database` to move databases from one Oracle Database home to another.

File Path

```
/opt/oracle/dcs/bin/odacli
```

Syntax

To upgrade an Oracle Database:

```
odacli upgrade-database -i Comma separated list of database ids -from source dbhome id -to destination dbhome id [-j] [-h] [-sh|-no-sh]
```

Parameters

Parameter	Description
<code>--databaseids, -i</code>	(Optional) Defines the Database IDs to upgrade. You can use a comma separated list of database IDs.
<code>--destDbHomeId, -to</code>	The DB HOME ID of the destination database home.
<code>--sourceDbHomeId, -from</code>	The DB HOME ID of the source database home.
<code>--json, -j</code>	(Optional) Displays JSON output. The default is false.
<code>--disable-seha, -no-sh</code>	Specifies whether you want to disable Standard Edition High-Availability for Oracle Database Standard Edition 19c and later single-instance databases.
<code>--enable-seha, -sh</code>	Specifies whether you want to enable Standard Edition High-Availability for Oracle Database Standard Edition 19c and later single-instance databases.
<code>--help, -h</code>	(Optional) Displays help for using the command.

Usage Notes

You cannot upgrade Oracle RAC or Oracle RAC One Node Database to a destination database home of Standard Edition 19c or later. You must first convert Oracle RAC or Oracle RAC One Node Database to single-instance Oracle Database using the `odacli modify-database` command and then upgrade the single-instance Oracle Database to a destination database home of Standard Edition 19c or later.

You have the following options for defining the databases to upgrade:

- When you define a single database ID, only the database of the source database home is upgraded.
- When you define more than one database ID, only those databases of the source database home are upgraded.
- When you do not define a database ID, all of the databases under the source database home are upgraded.

You can upgrade databases of the following releases:

- Oracle Database 18c to 19c
- Oracle Database 12.2 to 19c
- Oracle Database 12.1 to 19c
- Oracle Database 11.2.0.4 to 19c
- Oracle Database 12.2 to 18c
- Oracle Database 12.1 to 18c
- Oracle Database 11.2.0.4 to 18c
- Oracle Database 12.1 to 12.2
- Oracle Database 11.2.0.4 to 12.2
- Oracle Database 11.2.0.4 to 12.1

Example 14-116 Upgrading an Oracle Database

In this example, a single database is upgraded. Use the command `odacli list-databases` to display the database ID, then use the command `odacli upgrade-databases` to upgrade the 11.2.0.4 database. After the upgrade is complete, you can run the command `odacli list-databases` again to verify the upgrade.

```
# odacli list-databases
```

ID	DB Name	DB Version	CDB
ad6c7326-e460-411e-94df-230dedbef743	rdb121a	11.2.0.4	true
fb4d02f3-2413-47ca-8584-a768e23ec2e7	ee12db	12.1.0.2	false

```
(Continued)
Class Shape Storage Status
-----
OLTP odb1 ACFS Configured
IMDB odb1 ASM Configured
```

```
# odacli upgrade-database -i ad6c7326-e460-411e-94df-230dedbef743 -from
fa4321f5-0543-477d-bb54-a429dcc8ee8d -to d752df28-ecdd-4af4-9454-38085ea17f8b
{
  "jobId" : "1bbe8boe-acb0-4296--9c8b-473b69da0c18",
  "status" : "Created",
  "message" : null,
  "reports" : [ ],
  "createTimestamp" : "October 24, 2017 03:54:03 AM EDT",
  "description" : "Database service upgrade with db ids: [ad6c7326-
e460-411e-94df-230dedbef743]",
  "updatedAtTime" : "October 24, 2017 03:54:03 AM EDT"
}

# odacli list-databases
```

ID	DB Name	DB Version	CDB
ad6c7326-e460-411e-94df-230dedbef743	rdb121a	12.1.0.2	true
fb4d02f3-2413-47ca-8584-a768e23ec2e7	ee12db	12.1.0.2	false

```
(Continued)
Class Shape Storage Status
-----
OLTP odb1 ACFS Configured
```

IMDB odb1 ASM Configured

odacli DBHome Commands

Use the `odacli DBHome` commands to manage database Home operations.

- [odacli create-dbhome](#)
Use the `odacli create-dbhome` command to create an Oracle Database Home.
- [odacli delete-dbhome](#)
Use the `odacli delete-dbhome` command to delete database home that is not associated with a database.
- [odacli describe-dbhome](#)
Use the `odacli describe-dbhome` command to display Oracle Database Home details.
- [odacli list-dbhomes](#)
Use the `odacli list-dbhomes` command to display a list of Oracle Home directories.

odacli create-dbhome

Use the `odacli create-dbhome` command to create an Oracle Database Home.

File Path

```
$ORACLE_HOME/opt/oracle/dcs/bin/odacli
```

Syntax

To create an Oracle Database Home:

```
odacli create-dbhome -v version [-j] [-h]
```

Parameters

Parameter	Description
<code>-v <i>version number</i></code>	Defines the database bundle patch number.
<code>--json, -j</code>	(Optional) Displays JSON output.
<code>--help, -h</code>	(Optional) Displays help for using the command.

Usage Notes

For the version number, you can specify the database version, such as 18.7.0.0, 18.5.0.0, 12.2.0.1, 12.1.0.2 or 11.2.0.4, or you can use a 5 digit format to specify a specific patch bundle version. For example, 19.10.0.0.210119. If you use the database version without specifying the bundle patch number, then the latest bundle patch is used.

 **Note:**

Oracle Database 11.2.0.4.160419 is not supported. Attempts to create an Oracle Database 11.2 against an 11.2.0.4.160419 database home will fail.

Example 14-117 Creating an Oracle Database Home

The following example creates an Oracle Database Home version 19.10.0.0.210119.

```
# odacli create-dbhome -v 19.10.0.0.210119
```

odacli delete-dbhome

Use the `odacli delete-dbhome` command to delete database home that is not associated with a database.

File Path

```
$ORACLE_HOME/opt/oracle/dcs/bin/odacli
```

Syntax

```
odacli delete-dbhome -i [-h]
```

Parameters

Parameter	Description
<code>--id, -i</code>	Identifies the database home using a database identifier (ID).
<code>--help, -h</code>	(Optional) Displays help for using the command.

Usage Notes

- Use the `odacli list-dbhomes` command to locate the identifier.
- To delete, or uninstall, a database home (dbhome), there must not be any associated databases in the dbhome.
- Use the `odacli delete-database` command to delete an existing database.

Example 14-118 Deleting an Empty Database Home

```
# odacli delete-dbhome -i 0ce547ca-3df2-4178-a7e6-eefa613aeab4
```

odacli describe-dbhome

Use the `odacli describe-dbhome` command to display Oracle Database Home details.

File Path

```
$ORACLE_HOME/opt/oracle/dcs/bin/odacli
```

Syntax

To display details about Oracle Database Home:

```
odacli describe-dbhome -i dbhomeid [-h] [-j] [-v]
```

Parameters

Parameter	Description
<code>-i <i>dbhomeid</i></code>	Identifies the database home ID. Use the <code>odacli list-dbhomes</code> command to get the <i>dbhomeid</i> .
<code>--help, -h</code>	(Optional) Displays help for using the command.
<code>--json, -j</code>	(Optional) Displays JSON output. The default is false.
<code>-v<i>dbversion</i></code>	(Optional) Identifies the Database Home Version. Use the <code>odacli list-dbhomes -v</code> command to get the <i>dbversion</i> .

Example 14-119 Displaying Oracle Database Home Details

The following output is an example of using the display Oracle Database Home details command:

```
# odacli describe-dbhome -i b727bf80-c99e-4846-ac1f-28a81a725df6

DB Home details
-----
                ID: b727bf80-c99e-4846-ac1f-28a81a725df6
                Name: OraDB12102_home1
                Version: 12.1.0.2
Home Location: /u01/app/orauser/product/12.1.0.2/dbhome_1
Created: Jun 2, 2016 10:19:23 AM
```

odacli list-dbhomes

Use the `odacli list-dbhomes` command to display a list of Oracle Home directories.

File Path

```
$ORACLE_HOME/opt/oracle/dcs/bin/odacli
```

Syntax

To display a list of Oracle Home directories:

```
odacli list-dbhomes [-h] [-j]
```

Parameters

Parameter	Description
--help,-h	(Optional) Displays help for using the command.
--json,-j	(Optional) Displays JSON output.

Example 14-120 Displaying a List of Oracle Home Directories

Run the following command to display a list of Oracle Home directories:

```
# odacli list-dbhomes
```

ID	Name	DB Version
b727bf80-c99e-4846-ac1f-28a81a725df6	OraDB12102_home1	12.1.0.2

(continued)

Home Location

```
-----  
/u01/app/orauser/product/12.1.0.2/dbhome_1
```

odacli Database Storage Commands

Use the Database Storage commands to list, describe, create, and delete Oracle database storage.

- [odacli create-dbstorage](#)
Use the `odacli create-dbstorage` command to create the file system for database migrations.
- [odacli delete-dbstorage](#)
Use the `odacli delete-dbstorage` command to delete database storage that is not associated with a database.
- [odacli describe-dbstorage](#)
Use the `odacli describe-dbstorage` command to display storage configuration details.
- [odacli describe-dgstorage](#)
Use the `odacli describe-dgstorages` command to display the disk group information.
- [odacli list-dbstorages](#)
Use the `odacli list-dbstorages` command to display a list of all of the database storage configured in the appliance.

- [odacli list-dgstorages](#)
Use the `odacli list-dgstorages` command to display the disk group information.
- [odacli modify-dbstorage](#)
Use the `odacli modify-dbstorage` command to resize the database storage.
- [odacli update-dgstorage](#)
Use the `odacli update-dgstorage` command to release disks.

odacli create-dbstorage

Use the `odacli create-dbstorage` command to create the file system for database migrations.

File Path

```
$ORACLE_HOME/opt/oracle/dcs/bin/odacli
```

Syntax

```
odacli create-dbstorage -n dbname -s dataSize -u databaseUniqueName -r [ASM|ACFS] [-h]
```

Parameters

Parameter	Description
--dbname, -n	Defines the name of the database.
--dataSize, -s	(Optional) Defines the size, in gigabytes (GB), of the filesystem for storing database files and temp files. The default is: 100 GB The minimum size is 10 GB. When entering the size, do not include GB. For example, for 50 GB, use 50.
--databaseUniqueName, -u	(Optional) Defines a unique name for the database. Specify only if the database unique name is different than the database name. The command creates the following mount point: <code>/u02/app/oracle/oradata/db unique name</code>
--dbstorage, -r [ASM ACFS]	(Optional) Defines the type of database storage, either ASM or ACFS. When you select ASM, the command only creates the supporting directory structure for storing non-database files. The default is: ASM
--help, -h	(Optional) Displays help for using the command.

Usage Notes

- The `odacli create-dbstorage` command registers the storage metadata with the Appliance Manager.

- Oracle Database is supported on both Oracle Automatic Storage Management (Oracle ASM) and Oracle ASM Cluster file system (ACFS). The default is Oracle ASM.
- When you create ACFS database storage, the command creates a separate ACFS file system and creates the directory structure for other database files, such as archives and online logs.
- When you create ASM database storage, the command only creates the corresponding directories for non-database files.

Example 14-121 Creating Database Storage

The following statement creates 50 GB ACFS database storage for the APPSDB database.

```
# odacli create-dbstorage -n APPSDB -s 50 -r ACFS
{
  "jobId" : "fc6bf8fd-60c2-44f3-b8b7-efd0e9a2149f",
  "status" : "Created",
  "message" : null,
  "reports" : [ ],
  "createTimestamp" : "August 09, 2016 06:19:35 AM WSST",
  "description" : "Database storage service creation with db name:
APPSDB",
  "updatedAtTime" : "August 09, 2016 06:19:35 AM WSST"
}
```

odacli delete-dbstorage

Use the `odacli delete-dbstorage` command to delete database storage that is not associated with a database.

File Path

`$ORACLE_HOME/opt/oracle/dcs/bin/odacli`

Syntax

```
odacli delete-dbstorage -i [-h]
```

Parameters

Parameter	Description
<code>--id, -i</code>	Identifies the database storage using a database identifier (ID).
<code>--help, -h</code>	(Optional) Displays help for using the command.

Usage Notes

- You can only use the `delete-dbstorage` when the storage is not associated with any databases.
- Use the `delete-database` command to delete an existing database.

- Use the `list-dbstorages` command to locate the identifier.

Example 14-122 Deleting Empty Database Storage

```
# odacli delete-dbstorage -i 9fe39332-cc1a-4b4b-8393-165524a6ef6b
```

odacli describe-dbstorage

Use the `odacli describe-dbstorage` command to display storage configuration details.

File Path

```
$ORACLE_HOME/opt/oracle/dcs/bin/odacli
```

Syntax

```
odacli describe-dbstorage -i [-j] [-h]
```

Parameters

Parameter	Description
<code>--id, -i</code>	Identifies the database storage.
<code>--json, -j</code>	(Optional) Displays JSON output. The default is false.
<code>--help, -h</code>	(Optional) Displays help for using the command.

Usage Notes

- Use the `odacli list-dbstorages` command to get the database storage identifier (ID).
- The DATA Location corresponds to the `init.ora` parameter `db_create_file_dest`.
- RECO Location corresponds to the `init.ora` parameter `db_recovery_file_dest`
- REDO Location corresponds to the `init.ora` parameter `db_create_online_log_dest_1`

Example 14-123 Displaying Database Oracle ACFS Storage Details

The following example displays Oracle ASM Cluster file system (ACFS) storage details:

```
# odacli describe-dbstorage -i 9fe39332-cc1a-4b4b-8393-165524a6ef6b

DBStorage details
-----
ID: 9fe39332-cc1a-4b4b-8393-165524a6ef6b
DB Name: rdb121a
DBUnique Name: rdb121a
```

```
DB Resource ID: ad6c7326-e460-411e-94df-230dedbef743
Storage Type: Acfs
DATA Location: /u02/app/oracle/oradata/rdb121a
RECO Location: /u03/app/oracle/fast_recovery_area/
REDO Location: /u03/app/oracle/redo/
State: ResourceState(status=Configured)
Created: July 22, 2016 12:07:12 PM SGT
UpdatedTime: July 22, 2016 12:26:39 PM SGT
```

Example 14-124 Displaying Database Oracle ASM Storage Details

The following example displays Oracle Automatic Storage Management (Oracle ASM) storage details:

```
# odacli describe-dbstorage -i 4f2alb59-ca66-4d80-951c-425ab7b0acae

DBStorage details
-----
ID: 4f2alb59-ca66-4d80-951c-425ab7b0acae
DB Name: ee12db
DBUnique Name: ee12db
DB Resource ID: fb4d02f3-2413-47ca-8584-a768e23ec2e7
Storage Type: Asm
DATA Location: DATA
RECO Location: RECO
REDO Location: RECO
State: ResourceState(status=Configured)
Created: July 22, 2016 1:13:51 PM SGT
UpdatedTime: July 22, 2016 1:13:52 PM SGT
```

odacli describe-dgstorage

Use the `odacli describe-dgstorage` command to display the disk group information.

File Path

```
$ORACLE_HOME/opt/oracle/dcs/bin/odacli
```

Syntax

```
odacli describe-dgstorage -d diskgroup -h
```

Parameters

Parameter	Description
<code>--diskgroup, -d</code>	Specifies the disk group for which information is displayed.
<code>--help, -h</code>	(Optional) Displays help for using the command.

Usage Notes

This command displays the storage information for all the databases backed by a disk group, for each disk group present in the system.

Example 14-125 Displaying Disk Group Storage

```
# odacli list-dgstorages -r redundancy
Diskgroup storage details
```

```
-----
-----
Diskgroup: DATA
```

```
Redundancy: extern|normal|high|flex
```

```
Physical Free Space: wGB
```

```
Physical Total Space: xGB
```

```
Database Unique Name: rdbx
```

```
Location: /u02/app/test/test1/rdbx
```

```
Used Space: dGB (acfsutil.total -
acfsutil.freespace)
```

```
Free Space: dGB
(acfsutil.freespace)
```

```
Database Unique Name: rdby
```

```
Location: +DATA/rdby
```

```
Used Space: zGB (v$asm_file.bytes)
```

```
Free Space: xGB (PhyFree/
redundancy)
```

```
Physical Space:
vGB(v$asm_diskgroup.total_mb)
```

```
Physical Used : wGB
(v$asm_file.space)
```

```
Physical Free :
uGB(v$asm_diskgroup.free_mb)
```

```
Physical Reserved : uGB(Lookup
Table)
```

```

Diskgroup: RECO

Redundancy: normal|high|flex

Physical Free Space: wGB

Physical Total Space: xGB

Database Unique Name: rdbx

fast_recovery_area
Location: /u02/app/test/

acfsutil.freespace)
Used Space: dGB (acfsutil.total -

(acfsutil.freespace)
Free Space: dGB

Database Unique Name: rdby

Location: +DATA/rdby

Used Space: zGB (v$asm_file.bytes)

Free Space: xGB (PhyFree/

redundancy)

Physical Space:

vGB(v$asm_diskgroup.total_mb)

Physical Used : wGB

(v$asm_file.space)

Physical Free :

uGB(v$asm_diskgroup.free_mb)

Physical Reserved : uGB(Lookup

Table)

```

odacli list-dbstorages

Use the `odacli list-dbstorages` command to display a list of all of the database storage configured in the appliance.

File Path

```
/opt/oracle/dcs/bin/odacli
```

Syntax

```
# odacli list-dbstorages [-h]
```

Parameters

Parameter	Description
--help, -h	(Optional) Displays help for using the command.

Usage Notes

This command displays a list of all of the filesystems that are configured with the `create-database` command and the `create-dbstorage` command.

Example 14-126 Displaying a List of all Database Storage

```
# odacli list-dbstorages
```

ID Type	DBUnique	Name	Status
9fe39332-cc1a-4b4b-8393-165524a6ef6b	Acfs	rdb121a	Configured
4f2a1b59-ca66-4d80-951c-425ab7b0acae	Asm	ee12db	Configured
0266edac-c729-4539-861f-3f3d543be9e4	Acfs	db12SE	Configured

odacli list-dgstorages

Use the `odacli list-dgstorages` command to display the disk group information.

File Path

```
/opt/oracle/dcs/bin/odacli
```

Syntax

```
odacli list-dgstorages -r redundancy -h
```

Parameters

Parameter	Description
--redundancy, -r	Specifies the disk group redundancy for FLEX disk group.
--help, -h	(Optional) Displays help for using the command.

Usage Notes

- The command displays the storage-related information for all the disk groups present in the system.

- The redundancy option is valid only for FLEX disk groups. For all disk groups that are not FLEX, logical free space is calculated using the redundancy obtained from v\$asm_diskgroup rather than the CLI option.
- Redundancy option can take the values MIRROR | HIGH. Use one of these options to specify the database redundancy for FLEX disk groups.
- In the example below, Physical Total Space is the total space in the disk group. (V\$ASM_DISKGROUP.total_mb) Physical Reserved Space is the reserved space required to handle disk failures. Physical Free Space is the free space in the disk group. (V\$ASM_DISKGROUP.free_mb) Logical Free Space is the logical free space in the disk group. (V\$ASM_DISKGROUP.free_mb / redundancy)

This command displays the storage information for all the databases backed by a disk group, for each disk group present in the system.

Example 14-127 Displaying Disk Group Storage

```
# odacli list-dgstorages -r redundancy
Diskgroup Redundancy Physical Total Space Physical Reserved Space
Physical Free Space Logical Free
Space
-----
DATA          FLEX          xGB
yGB
          zGB          uGB

REDO          HIGH          xGB
yGB
          zGB          uGB

RECO          NORMAL        xGB
yGB
          zGB          uGB
```

odacli modify-dbstorage

Use the `odacli modify-dbstorage` command to resize the database storage.

File Path

```
/opt/oracle/dcs/bin/odacli
```

Syntax

```
odacli modify-dbstorage [-ds] [-in] [-fs] [-rcs] [-rds] [-h] [-j]
```

Parameters

Parameter	Description
--datasize, -ds	(Optional) Specifies the extendable size in GB for the DATA volume. Specify at least one size from FLASH, RECO, REDO, or DATA volumes.
--dbname, -in	Defines the database name on which you want to extend the volumes.
--flashsize, -fs	(Optional) Specifies the extendable size in GB for the FLASH volume.
--recoresize, -rcs	(Optional) Specifies the extendable size in GB for the RECO volume.
--redosize, -rds	(Optional) Specifies the extendable size in GB for the REDO volume.
--help, -h	(Optional) Displays help for using the command.
--json, -j	(Optional) Displays JSON output.

Usage Notes

- The command can resize DATA, RECO, REDO, and FLASH volumes.
- Database name is a mandatory parameter. All other parameters are optional, however, one of the volume sizes must be specified. If you only provide the DATA size, then the DCS agent calculates the recommended RECO size for the given DATA size is internally calculated. The storage is then extended with the recommended values.
- The mounted Oracle ACFS and its underlying Oracle ADVM storage is resized to match the new size specified.
- To check the result of the resize operation, use the `odacli list-dbstorages` command.
- After database resize operation is completed, use the `odacli describe-dbstorage` command to display storage configuration details.

Example 14-128 Modifying the Database Storage

```
# odacli modify-dbstorage -ds 10 -rcs 15 -n amdb1
{
  "jobId" : "e6d54155-ed4c-4fd6-a3f6-454120fa5c18",
  "status" : "Created",
  "message" : null,
  "reports" : [ ],
  "createTimestamp" : "June 03, 2019 06:06:42 AM UTC",
  "resourceList" : [ ],
  "description" : "Database storage modify operation",
  "updateTime" : "June 03, 2019 06:06:42 AM UTC"
}
```

odacli update-dgstorage

Use the `odacli update-dgstorage` command to release disks.

File Path

```
/opt/oracle/dcs/bin/odacli
```

Syntax

To release disks:

```
odacli update-dgstorage [-h] [-f] [-rd] [-j]
```

Parameters

Parameter	Description
<code>--json, -j</code>	(Optional) Displays JSON output.
<code>--help, -h</code>	(Optional) Displays help for using the command.
<code>--force, -f</code>	(Optional) Forces release of specified disks. When this option is specified, the check to verify that all disk groups are mounted on the current node is skipped.
<code>--release-disk, -rd</code>	Specifies the disks to release. Generally, this specifies a single storage device with partitions on different disk groups. You can also specify a comma-separated list of disks to release.

Usage Notes

- Run the `odacli list-dgdisks` to view details of the disk, before running the `odacli update-dgstorage` command.
- The `odacli update-dgstorage` command runs a precheck to ensure all disk groups are mounted on the node. You can use the `-f` option to override the precheck.

Example 14-129 Releasing a physical disk `HDD_E0_S10_577135552` which has two logical partitions on two different disk groups

```
# odacli update-dgstorage -rd HDD_E0_S10_577135552
```

```
Job details
```

```
-----
                ID: 46bc736c-417b-4ac2-826e-aa857db50e29
Description:    Release disks: [HDD_E0_S10_577135552]
                Status: Running
                Created: July 7, 2020 6:24:27 PM PDT
                Message: Release ASM disks
```

Verifying the result of the Release Disks operation:

```
# odacli describe-job -i 46bc736c-417b-4ac2-826e-aa857db50e29
```

Job details

```
-----  
ID: 46bc736c-417b-4ac2-826e-aa857db50e29  
Description: Release disks: [HDD_E0_S10_577135552]  
Status: Success  
Created: July 7, 2020 6:24:27 PM PDT  
Message: Release ASM disks
```

odacli Job Commands

Use the `odacli list-jobs` and `odacli describe-job` commands to display job details.

- [odacli create-jobdata-retention-policy](#)
Use the `odacli create-jobdata-retention-policy` command to create job data retention policy for default DCS jobs and specific auto scheduled jobs.
- [odacli create-purge-jobdata-job](#)
Use the `odacli create-purge-jobdata-job` command to create a job to delete data for default DCS jobs and specific auto scheduled jobs.
- [odacli delete-jobdata-retention-policy](#)
Use the `odacli delete-jobdata-retention-policy` command to delete job data retention for default DCS jobs and specific auto scheduled jobs.
- [odacli describe-job](#)
Use the `odacli describe-job` command to display details about a specific job, including the job ID, status, tasks, and the job created date and time stamp.
- [odacli list-jobs](#)
Use the `odacli list-jobs` command to display a list of jobs, including the job IDs, status, and the job created date and time stamp.
- [odacli list-jobdata-retention-policy](#)
Use the `odacli list-jobdata-retention-policy` command to list job data retention policy for default DCS jobs and specific auto scheduled jobs.
- [odacli list-purge-jobdata-job](#)
Use the `odacli list-purge-jobdata-job` command to list purge job data for default DCS jobs and specific auto scheduled jobs.
- [odacli list-scheduled-executions](#)

odacli create-jobdata-retention-policy

Use the `odacli create-jobdata-retention-policy` command to create job data retention policy for default DCS jobs and specific auto scheduled jobs.

File Path

```
/opt/oracle/dcs/bin/odacli
```

Syntax

To create job data retention policy:

```
odacli create-jobdata-retention-policy [-j] [-h] [-w] [-s]
```

Parameters

Parameter	Description
--json, -j	(Optional) Displays JSON output.
--help, -h	(Optional) Displays help for using the command.
--retentionWindow, -w	(Optional) Describes the time interval to retain the job data. Default is 30 days if not specified.
--retentionWindowUnit, -u	(Optional) Describes the unit for the retentionWindow. Possible values are Day Hour Minute. Default is Day if no value is specified.
--scheduleIds, -s	(Optional) Specifies the IDs, delimited by commas, of the scheduled jobs similar to the odacli list-schedules result. Use Default for all DCS jobs.

Usage Notes

- Once a policy is created, an auto scheduled job is created to start purging DCS job records regularly, for example, every day at 4 AM, based on the retention policies you define.

Example 14-130 Creating a default policy to purge all the jobs and scheduled executions older than 30 days

```
# odacli create-jobdata-retention-policy
```

```
Job details
```

```
-----
ID: 36d00489-39b1-425f-81bf-6d6e3bfede8b
Description: set job data retention policy
Status: Created
Created: April 23, 2020 3:32:09 PM PDT
Message:
```

```
Task Name Start Time End Time Status
```

```
-----
[root@oda1]# ./odacli describe-job -i c40c17f0-4185-40fe-
a126-30fe1f0e5cdd
```

```
Job details
```

```
-----
ID: c40c17f0-4185-40fe-a126-30fe1f0e5cdd
Description: set job data retention policy
Status: Success
Created: April 23, 2020 5:42:28 PM PDT
```

```
Message:
```

```
Task Name Start Time End Time Status
```

```

-----
-----
set job data retention policy  April 23, 2020 5:42:28 PM PDT  April
23, 2020 5:42:28 PM PDT  Success
create auto job data schedule  April 23, 2020 5:42:28 PM PDT  April
23, 2020 5:42:28 PM PDT  Success

```

Example 14-131 Set up a retention policy of 10 days for the schedule 'archive_log_backup'

```
# odacli create-jobdata-retention-policy -s 284a22b5-41e6-4be1-
a916-048eac74e076 -w 10 -u Day
```

Job details

```

-----
ID: ea68a90e-a8e2-4fc4-a4f1-75461e12c387
Description: set job data retention policy
Status: Created
Created: April 23, 2020 6:22:14 PM PDT

```

Message:

```
Task Name Start Time End Time Status
-----
```

```
[root@odal]# ./odacli list-jobdata-retention-policy
```

```

Schedule Id      Retention Window  Unit      Modified
-----
Default         20              Day       April 23, 2020 6:16:59 PM PDT
284a22b5-41e6-4be1-a916-048eac74e076  10 Day       April 23, 2020
6:22:14 PM PDT

```

odacli create-purge-jobdata-job

Use the `odacli create-purge-jobdata-job` command to create a job to delete data for default DCS jobs and specific auto scheduled jobs.

File Path

```
/opt/oracle/dcs/bin/odacli
```

Syntax

To create job data purge:

```
odacli create-purge-jobdata-job [-j] [-h] [-i] [-o] [-u] [-s]
```

Parameters

Parameter	Description
--json, -j	(Optional) Displays JSON output.
--help, -h	(Optional) Displays help for using the command.
--jobIds, -i	(Optional) Purges data for given DCS job IDs, delimited by commas.
--olderThan, -o	(Optional) Purges job data older than the specified time. If not specified, use the existing retentionWindow value.
--olderThanUnit, -u	(Optional) Describes the unit for the OlderThan option. Possible values are Day Hour Minute. If not specified, use the existing retentionWindow value.
--scheduleIds, -s	(Optional) Specifies the IDs, delimited by commas, of the scheduled jobs similar to the odacli list-schedules result.

Example 14-132 Creating a job to purge job data

```
# odacli create-purge-jobdata-job

Job details
-----
ID: e43dbd56-dc7c-4812-b653-0fc3208e0929
Description: purge job data
Status: Created
Created: April 23, 2020 6:27:40 PM PDT

Message:
Task Name Start Time End Time Status
-----
-----

[root@odal1]# odacli describe-job -i e43dbd56-dc7c-4812-
b653-0fc3208e0929
Job details
-----
ID: e43dbd56-dc7c-4812-b653-0fc3208e0929
Description: purge job data

Status: Success
Created: April 23, 2020 6:27:40 PM PDT
Message: Purged 21 metadata records and 10 files. Purge policies are:
Purge all jobs and scheduled executions older than 30 Days
Purge scheduled executions for ID:284a22b5-41e6-4be1-a916-048eac74e076
older than 10 Day

Task Name Start Time End Time Status
-----
-----
```

```
-----  
purge job data April 23, 2020 6:27:40 PM PDT April 23, 2020 6:27:40  
PM PDT Success
```

Example 14-133 Purging job data older than 5 hours, including all jobs and scheduled executions related records

```
# odacli create-purge-jobdata-job -o 5 -u Hour  
Job details  
-----  
ID: 4d065c96-a8eb-4974-a446-573b5ad3cb95  
Description: purge job data  
Status: Created  
Created: April 23, 2020 1:55:59 PM PDT  
Message:  
Task Name Start Time End Time Status  
-----  
-----  
[root@oda1]# odacli describe-job -i 4d065c96-a8eb-4974-  
a446-573b5ad3cb95  
  
Job details  
-----  
ID: 4d065c96-a8eb-4974-a446-573b5ad3cb95  
Description: purge job data  
Status: Success  
Created: April 23, 2020 1:55:59 PM PDT  
Message: Purged 242 metadata records and 0 files. Purge policies are:  
Purge all jobs and scheduled executions older than 5 Hour  
  
Task Name Start Time End Time Status  
-----  
-----  
purge job data April 23, 2020 1:55:59 PM PDT April 23, 2020  
1:55:59 PM PDT Success
```

Example 14-134 Purging job data for multiple jobs

```
# odacli create-purge-jobdata-job -i 87a926cd-a243-49e0-  
ba02-9d8968e1de1e,0e2a38c0-041a-41d8-91ad-7f9f7c646f12  
  
Job details  
-----  
ID: 217cbdbf-15a5-47d3-9582-3f26d6b5eebf  
Description: purge job data  
Status: Created  
Created: April 23, 2020 2:01:25 PM PDT  
Message: Task Name Start Time End Time Status  
-----  
-----  
-----
```



```
[root@oda1]# odacli describe-job -i
217cbdbf-15a5-47d3-9582-3f26d6b5eebf
Job details
-----
ID: 217cbdbf-15a5-47d3-9582-3f26d6b5eebf
Description: purge job data
Status: Success
Created: April 23, 2020 2:01:25 PM PDT
Message: Purged 11 metadata records and 0 files. Purge policies are:
Purge job with ID:87a926cd-a243-49e0-ba02-9d8968e1de1e
Purge job with ID:0e2a38c0-041a-41d8-91ad-7f9f7c646f12

Task Name Start Time End Time Status
-----
-----
purge job data      April 23, 2020 2:01:25 PM PDT      April 23, 2020
2:01:25 PM PDT      Success
```

Example 14-135 Purging job data for specific job data schedules older than 5 days

```
# odacli create-purge-jobdata-job -s 39cc86d6-30c2-4744-bfbc-
e62535e2aa67,31b3a83b-76ca-44d3-9268-b4dac948e217 -o 5 -u Day

Job details
-----
ID: be839a81-a79b-43ce-bf70-c8abala9cc91
Description: purge job data
Status: Created
Created: April 23, 2020 2:44:54 PM PDT
Message:

Task Name Start Time End Time Status
-----
-----

[root@oda1]# ./odacli describe-job -i be839a81-a79b-43ce-bf70-
c8abala9cc91

Job details
-----
ID: be839a81-a79b-43ce-bf70-c8abala9cc91
Description: purge job data
Status: Success
Created: April 23, 2020 2:44:54 PM PDT
Message: Purged 0 metadata records and 0 files. Purge policies are:
Purge scheduled executions for ID:39cc86d6-30c2-4744-bfbc-e62535e2aa67
older than 5 Day
Purge scheduled executions for ID:31b3a83b-76ca-44d3-9268-b4dac948e217
older than 5 Day
Task Name Start Time End Time Status
-----
```

```
-----
-----
purge job data April 23, 2020 2:44:54 PM PDT April 23, 2020 2:44:54 PM
PDT Success
```

odacli delete-jobdata-retention-policy

Use the `odacli delete-jobdata-retention-policy` command to delete job data retention for default DCS jobs and specific auto scheduled jobs.

File Path

```
/opt/oracle/dcs/bin/odacli
```

Syntax

To delete job data retention:

```
odacli delete-jobdata-retention-policy [-j] [-h][-s]
```

Parameters

Parameter	Description
<code>--json, -j</code>	(Optional) Displays JSON output.
<code>--help, -h</code>	(Optional) Displays help for using the command.
<code>--scheduleIds, -s</code>	(Optional) Specifies the IDs applied by the job data retention policy. If not supplied, delete all the existing policies.

Example 14-136 Deleting the job data retention policies

```
# odacli delete-jobdata-retention-policy

Job details
-----
ID: ab819d57-9e35-4f55-bd5e-d26fc6372448
Description: delete job data retention policy
Status: Running
Created: April 23, 2020 7:34:05 PM PDT

Message:
Task Name Start Time End Time Status
-----
-----
remove job data retention policy entries      April 23, 2020 7:34:05
PM PDT          April 23, 2020 7:34:05 PM PDT      Running

[root@odal1]# odacli describe-job -i ab819d57-9e35-4f55-bd5e-
d26fc6372448
```

Job details

```

-----
ID: ab819d57-9e35-4f55-bd5e-d26fc6372448
Description: delete job data retention policy
Status: Success
Created: April 23, 2020 7:34:05 PM PDT
Message:

```

```

Task Name Start Time End Time Status
-----
-----

```

```

remove job data retention policy entries      April 23, 2020 7:34:05
PM PDT          April 23, 2020 7:34:05 PM PDT      Success
remove auto job data schedule                April 23, 2020 7:34:05
PM PDT          April 23, 2020 7:34:05 PM PDT      Success

```

```
[root@oda1]# odacli list-jobdata-retention-policy
```

```
DCS-10032:Resource JobDataRetentionPolicy is not found.
```

odacli describe-job

Use the `odacli describe-job` command to display details about a specific job, including the job ID, status, tasks, and the job created date and time stamp.

File Path

```
$ORACLE_HOME/opt/oracle/dcs/bin/odacli
```

Syntax

To view a specific job, status, and tasks:

```
odacli describe-job -i jobid [-j] [-h]
```

Parameters

Parameter	Description
<code>--jobid, -i <i>jobid</i></code>	Identifies the job. To get the job identifier (<i>jobid</i>), run the <code>list-jobs</code> command.
<code>--json, -j</code>	(Optional) Displays JSON output.
<code>--help, -h</code>	(Optional) Displays help for using the command.

Example 14-137 Displaying Details for a Job

To display details of a specific job with *jobid* `02df22c8-c21f-4162-8265-97f7826c243a`:

```
# odacli describe-job -i 02df22c8-c21f-4162-8265-97f7826c243a
```

odacli list-jobs

Use the `odacli list-jobs` command to display a list of jobs, including the job IDs, status, and the job created date and time stamp.

File Path

```
$ORACLE_HOME/opt/oracle/dcs/bin/odacli
```

Syntax

To list jobs and view job details and status:

```
odacli list-jobs [-j] [-h] [-o] [-f] [-t] [-hd] [-tl] [-k] [-s]
```

Parameters

Parameter	Description
<code>--json, -j</code>	(Optional) Displays JSON output.
<code>--help, -h</code>	(Optional) Displays help for using the command.
<code>--for, -o</code>	(Optional) Describes a job created on a specific date. In the format YYYY-MM-DD, such as 2018-01-01 . Example: <pre><code># odacli list-jobs -o 2018-08-09</code></pre>
<code>--from, -f</code>	(Optional) Describes a job created since a specific date. In the format YYYY-MM-DD or YYYY-MM-DD HH:mm:ss, such as 2018-01-01 or 2018-01-01 01:00:00. Examples: <pre><code># odacli list-jobs -f 2018-08-27</code> <code># odacli list-jobs -f "2018-08-27 03:00:00"</code></pre>
<code>--head, -hd</code>	(Optional) Describes the maximum number of older jobs to be displayed, values can be 1 to 200. Example: <pre><code>odacli list-jobs -hd 10</code></pre>

Parameter	Description
<code>--to, -t</code>	(Optional) Describes a job created ahead of a specific date. In the format YYYY-MM-DD or YYYY-MM-DD HH:mm:ss, such as 2018-01-01 or 2018-01-01 01:00:00. Example: # odacli list-jobs -t 2018-08-07
<code>--tail, -tl</code>	(Optional) Describes the maximum number of latest jobs to be displayed, values can be 1 to 200. Example: # odacli list-jobs -tl 10
<code>--keyword, -k</code>	(Optional) Specifies the keyword that the job description contains. Example: # odacli list-jobs -k OraDB
<code>--status, -s</code>	(Optional) Specifies the status of the job, such as Created, Scheduled, Running, Failure, Success, InternalError. Example: # odacli list-jobs -s Failure

Example 14-138 Displaying a List of Jobs

To display a list of jobs:

```
# odacli list-jobs
```

```
ID                               Description                               Created
-----
a6084067-72a1-4625-bea7-efd Provisioning service creation Jun 2,
2018 10:19:23 AM
```

(Continued)

Status

Success

Example 14-139 Displaying Specified Number of Older Jobs

To display a specified number of older jobs:

```
# odacli list-jobs -hd 5
ID Description Created Status
--- --- --
643c6186-a667-43d7-847f-d756a96fa072 Create detailed Backup Report
August 5, 2018 12:36:26 AM UTC Success
f29cb82c-6150-487d-aaff-52d65f6ab972 Create recovery-pitr : time
'08/05/2018 07:16:12'
for db : igIyoz August 5, 2018 1:01:39 AM UTC Success
cfe19337-ab2f-4ef3-85b5-24601ba31be2 Create detailed Backup Report
August 5, 2018 1:17:46 AM UTC Success
3749b5e2-240e-4df5-b3c1-32d345243b25 Create detailed Backup Report
August 5, 2018 2:01:07 AM UTC Success
64828852-bb16-4f06-aca9-4bdf9fe7b6f2 Create regular-5 Backup with TAG-
id5UNjBZ8HN2FYL
for Db:igIyoz August 5, 2018 2:14:19 AM UTC Success
```

Example 14-140 Displaying Jobs in a Date Range

To display jobs created within a time frame:

```
# ./odacli list-jobs -f 2018-08-07 -t 2018-08-08
ID Description Created Status
--- --- --
1fc5ef97-a9db-49b2-9664-7c551bd005f4 Authentication key update for
test_user August 7, 2018 12:56:58 AM UTC Success
e24f86cf-bb2e-4ebe-84e0-da5cedb27ad4 Provisioning service creation
August 7, 2018 1:00:54 AM UTC Success
7f67efd6-cce5-47b4-8dc4-fdb732491f99 CPU cores service update August 7,
2018 1:41:05 AM UTC Success
0ae9a312-bac8-43be-8a64-5a12c24c2a02 SSH keys update August 7, 2018
1:42:59 AM UTC Success
af41fdc1-87ff-46cd-bc41-26615e115ae7 SSH key delete August 7, 2018
1:44:56 AM UTC Success
79e4cbb0-b474-48ab-9e04-d3d602bc0ed2 DcsCli patching August 7, 2018
1:50:18 AM UTC Success
edd55e7d-f81f-4a10-942d-1121aef0bff3 DcsCli patching August 7, 2018
1:50:32 AM UTC Success
acc22c60-3476-4566-8faa-4d36b116eded create backup
config:aaaaaaaaaaaaaaaaaaaaaaaaaaaa August 7, 2018 2:01:46 AM UTC
Success
d89efedf-9110-429a-a3b2-ccd6a53f8564 Database Home OraDB12201_home2
creation with version :12.2.0.1 August 7, 2018 2:36:05 AM UTC Success
2a5532ae-41fa-47c2-bc90-010a5f26d6b2 Database service creation with db
name: my122 August 7, 2018 3:52:38 AM UTC Success
c4e533e9-c596-478f-92db-2f11f1384075 Discover Components : all August
7, 2018 4:07:09 AM UTC Success
149e89b5-27d3-4c7c-9c03-f029ca3dd495 Discover Components : all August
7, 2018 4:08:45 AM UTC Success
21d4c37b-49ad-48dd-a1db-1f25d9288312 Database Home OraDB11204_home1
creation with version :11.2.0.4 August 7, 2018 4:19:32 AM UTC Success
b61dbbca-edc1-4a4a-9db2-82b0bdc64e6 Database service deletion with db
```

```
name: myTestDb with id : 6400c81d-5837-480c-b4a1-7c01591ee144 August 7,
2018 4:24:50 AM UTC Success
d4a104df-5796-4e37-9173-82f0e263d642 create backup config:bkfgd August
7, 2018 4:28:54 AM UTC Success
a121d40b-f33b-47a4-8fc6-4e3b84173f44 Database service creation with db
name: my112 August 7, 2018 6:51:13 PM UTC Success
42dd661f-9ba0-4877-ace9-39d3f212c071 Discover Components : all August
7, 2018 7:12:56 PM UTC Success
2f648f5a-c9c5-42ec-adb0-98cf6497c89e Discover System Components :
system August 8, 2018 3:28:12 AM UTC Success
a5755f43-509d-4d4c-b7ef-9f99660c4de7 DB Home Patching: Home Id is
97df26b3-42f2-4189-805b-82d1b38737d0 August 8, 2018 3:52:08 AM UTC
Success
79b0e697-065f-4630-a524-8d072a4e139a Database Home OraDB12102_home1
creation with version :12.1.0.2 August 8, 2018 4:34:30 AM UTC Success
112b75bc-3512-4c28-a479-3e0317eb0dc4 Database service creation with db
name: mynew121 August 8, 2018 8:02:51 AM UTC Failure
09f56fb0-1e91-4b02-a9b8-5add11a8da32 Database service creation with db
name: my121a August 8, 2018 9:13:01 AM UTC Success
5633ded9-07ea-4bf9-9533-31eb65789fe7 Database service deletion with db
name: mynew121 with id : 24be4362-16c8-476f-903a-f6f2ef59f5e4 August 8,
2018 9:24:31 AM UTC Success
458dlc45-02dc-456c-ae88-5da613faaa66 Database service creation with db
name: mynew121 August 8, 2018 9:27:31 AM UTC Success
f178f378-a9d7-4d5c-b6f5-6f62ea4e05bb Database service deletion with db
name: myTestDb with id : ef50387b-0c62-4446-b210-f8d070e2a043 August 8,
2018 9:40:43 AM UTC Success
7fab740f-a711-466a-ba6d-dd5643374c28 Database service deletion with db
name: myTestDb with id : 6632a083-558a-4eb4-8c2b-af0710179980 August 8,
2018 9:41:04 AM UTC Success
3121529d-2b9d-4bbe-bf58-996c2cf46996 Database service creation with db
name: mydss August 8, 2018 9:42:06 AM UTC Success
3d0a9261-19d7-42bb-8b92-00fcc4f8c41e Discover Components : db August 8,
2018 10:17:22 AM UTC Success
```

odacli list-jobdata-retention-policy

Use the `odacli list-jobdata-retention-policy` command to list job data retention policy for default DCS jobs and specific auto scheduled jobs.

File Path

```
/opt/oracle/dcs/bin/odacli
```

Syntax

To list jobs and view job details and status:

```
odacli list-jobdata-retention-policy [-j] [-h]
```

Parameters

Parameter	Description
--json, -j	(Optional) Displays JSON output.
--help, -h	(Optional) Displays help for using the command.

Example 14-141 Listing all job retention policies

```
# odacli list-jobdata-retention-policy

Schedule Id Retention Window Unit Modified
-----
Default      30 Days      April 23, 2020 6:16:59 PM PDT
284a22b5-41e6-4be1-a916-048eac74e076  10 Days      April 23, 2020
6:22:14 PM PDT
```

odacli list-purge-jobdata-job

Use the `odacli list-purge-jobdata-job` command to list purge job data for default DCS jobs and specific auto scheduled jobs.

File Path

```
/opt/oracle/dcs/bin/odacli
```

Syntax

To list job data purge policy:

```
odacli list-purge-jobdata-job [-j] [-h]
```

Parameters

Parameter	Description
--json, -j	(Optional) Displays JSON output.
--help, -h	(Optional) Displays help for using the command.

Usage Notes

The command describes the files that are purged, the purged count, the purged file size, and the time of purge.

Example 14-142 Listing history, statistics, and rules for job data purge jobs

```
# odacli list-purge-jobdata-jobs

Purge By Job                               Purged Object
Count      Size      Type      Purged Time
```



```
-----
-----
4d065c96-a8eb-4974-a446-573b5ad3cb95      TaskReport
102      Metadata      April 23, 2020 1:55:59 PM PDT
4d065c96-a8eb-4974-a446-573b5ad3cb95      ServiceJobReport
24      Metadata      April 23, 2020 1:55:59 PM PDT
4d065c96-a8eb-4974-a446-573b5ad3cb95      LogCleanupSummary
2      Metadata      April 23, 2020 1:55:59 PM PDT
4d065c96-a8eb-4974-a446-573b5ad3cb95      JobExecutionResource
93      Metadata      April 23, 2020 1:55:59 PM PDT
4d065c96-a8eb-4974-a446-573b5ad3cb95      JobDataPurgeResult
21      Metadata      April 23, 2020 1:55:59 PM PDT
```

odacli list-scheduled-executions

Use the command `odacli list-scheduled-executions` to display a list of jobs that were executed.

File Path

`$ORACLE_HOME/opt/oracle/dcs/bin/odacli`

Syntax

```
odacli list-scheduled-executions [-e] [-l] [-j] [-h]
```

Parameters

Parameter	Description
<code>--executionid, -e</code>	(Optional) Displays the execution ID.
<code>--scheduleid, -i</code>	(Optional) Displays the Schedule ID.
<code>--help, -h</code>	(Optional) Displays help for using the command.
<code>--json, -j</code>	(Optional) Displays JSON output. The default is false.

Example 14-143 Displaying a List of Scheduled and Executed Jobs

Display a list of scheduled tasks, the status, and the date and time that the task was executed. In the following example, three (3) scheduled tasks were executed. One task, Schedule ID `04b5750c-0d13-42cf-aba3-85416e8edafb`, was executed twice.

```
# odacli list-scheduled-executions

ID                               ScheduledId
JobId
-----
9890508c-ff6d-4307-972f-7962ec390871  04b5750c-0d13-42cf-
aba3-85416e8edafb
10a33e08-695c-4d13-b970-7dc7215f3cdd
7ee1e2aa-80a8-4297-97f7-365b84bcce4d
4a9e9796-4bed-4df7-af1e-de49362dda97  04b5750c-0d13-42cf-aba3-85416e8edafb

(Continued)
Status      Executed Time
```

```
-----
Executed February 4, 2018 12:00:00 AM UTC
Executed February 4, 2018 12:00:00 AM UTC
Executed February 5, 2018 12:00:00 AM UTC
```

To learn more about a scheduled backup, run the command `odacli list-schedules`. The output displays the ID, name, description, and schedule for each task.

```
# odacli list-schedules

ID                                     Name
Description
-----
d136cc72-4a80-4ab8-9f1e-120b995b2794  metastore maintenance
internal metastore maintenance
04b5750c-0d13-42cf-aba3-85416e8edafb    AgentState metastore cleanup
internal agentstateentry metastore maintenance
7ee1e2aa-80a8-4297-97f7-365b84bcce4d    backupreport maintenance
backup reports deletion

(Continued)
CronExpression                        Disabled
-----
0 0 0 1/1 * ? *                       true
0 0 0 1/1 * ? *                       false
0 0 0 1/3 * ? *                       false
```

Log Commands

Use the `odacli` log commands to specify the options to collect and delete logs.

- [odaadmcli manage diagcollect](#)
Use the `odaadmcli manage diagcollect` command to collect diagnostic logs for Oracle Database Appliance components.
- [odacli create-auto-logclean-policy](#)
Use the `odacli create-auto-logclean-policy` command to create a policy for a job to automatically purge log files for a specified time period when certain criteria are met.
- [odacli create-logcleanjob](#)
Use the `odacli create-logcleanjob` command to create a job to purge log files for a specified time period.
- [odacli describe-logcleanjob](#)
Use the `odacli describe-logcleanjob` command to describe a log cleanup job.
- [odacli list-auto-logclean-policy](#)
Use the `odacli list-auto-logclean-policy` command to list the jobs to purge log files.

- [odacli list-logcleanjobs](#)
Use the `odacli list-logcleanjobs` command to list the jobs to purge log files.
- [odacli list-logspaceusage](#)
Use the `odacli list-logspaceusage` command to display the log file usage.

odaadmcli manage diagcollect

Use the `odaadmcli manage diagcollect` command to collect diagnostic logs for Oracle Database Appliance components.

File Path

`$ORACLE_HOME/opt/oracle/dcs/bin/odaadmcli`

Syntax

To collect diagnostic logs for components:

```
odaadmcli manage diagcollect [-h] [--dataMask] [--dataSanitize] [--fromTime] [--toTime] [--Components]
```

Parameters

Parameter	Description
<code>--help, -h</code>	(Optional) Displays help for using the command.
<code>--dataMask</code>	(Optional) Masks sensitive data. The default is No.
<code>--dataSanitize</code>	(Optional) Sanitizes (redacts) sensitive data. The default is No.
<code>--fromTime</code>	(Optional) Specifies the time from when you want to collect data. The timestamp formats can be of the type: <code>mon/dd/yyyy hh:mm:ss</code> , or <code>yyyy-mm-dd hh:mm:ss</code> , or <code>yyyy-mm-ddThh:mm:ss</code> , or <code>yyyy-mm-dd</code> .
<code>--toTime</code>	(Optional) Specifies the time till when you want to collect data. The timestamp formats can be of the type: <code>mon/dd/yyyy hh:mm:ss</code> , or <code>yyyy-mm-dd hh:mm:ss</code> , or <code>yyyy-mm-ddThh:mm:ss</code> , or <code>yyyy-mm-dd</code> .
<code>--Components</code>	(Optional) Specifies the comma-separated list of components for which you want to collect data. The supported values are: <code>all, ips, oda, odalite, dcs, odabackup, odapatching, odadataguard, odaprovisioning, odaconfig, odasystem, odastorage, database, asm, crsclient, dbclient, dbwlm, tns, rhp, procinfo, afd, crs, cha, wls, emagent, oms, ocm, emplugins, em, acfs, install, cfgtools, os, ashhtml, ashtext, awrhtml, awrtext</code>
<code>--verbose</code>	Displays detailed message.

Usage Notes

The following types of sensitive information can be redacted using the `--dataMask` or the `--dataSanitize` option:

- Host names
- IP addresses
- Database names
- Tablespace names
- Service names
- Ports
- Operating System user names

For example, when the `--dataMask` option is used, all instances of a sensitive name such as a database name called "payrolldb" are replaced with "*****" in the TFA collection.

For example, when the `--dataSanitize` option is used, all instances of a sensitive name such as a database name called "payrolldb" are replaced with another string, such as "oCjIN7F8P", in the TFA collection.

Example 14-144 Masking Sensitive Data in Log Collection

```
# /opt/oracle/oak/bin/odaadmcli manage diagcollect --dataMask
DataMask is set as true
TFACTL command is: /opt/oracle/tfa/tfa_home/bin/tfactl
Data mask is set.
Collect data within last 12 hours as default
Please wait for several minutes for the collection to complete.
```

odacli create-auto-logclean-policy

Use the `odacli create-auto-logclean-policy` command to create a policy for a job to automatically purge log files for a specified time period when certain criteria are met.

File Path

```
$ORACLE_HOME/opt/oracle/dcs/bin/odacli
```

Syntax

To list jobs and view job details and status:

```
odacli create-auto-logclean-policy [-h] [-c] [-o] [-u] [-uMB] [-f]
[-uPer]
```

Parameters

Parameter	Description
--help, -h	(Optional) Displays help for using the command.
--components, -c	(Optional) Specifies the list of components, separated by comma. The values are <code>gi database dcs</code> . For example, <code>gi dcs</code> .
--olderthan, -o	(Optional) Cleans logs older than specified time interval. Default is 30 if it is not specified.
--olderThanUnit, -u	(Optional) Unit for the --olderthan parameter. Default is Day if it is not specified.
--freeSpaceBelowPercentage, -f	Starts purge when free disk space is below the specified number of percentage of the total partition size. Valid range is 20-50. Default is 20.
--usageOverMB, -uMB	Starts purge when log usage is over the specified number of MB. Valid range is 10%-50% of partition size.
--usageOverPercentage, -uPer	Starts purge when log usage is over the specified number of percentage of total partition space. Valid range is 10-50.

Example 14-145 Creating Automatic Jobs to Purge Logs

To create a policy for automatic jobs to purge logs:

```
# odacli create-auto-logclean-policy -c 'dcs' -o 30 -uPer 30
Component UsageOverPercentage freeSpaceBelowPercentage UsageOverMB
OlderThan OlderThanUnit
```

```
-----
-----
dcs          30          20
0           30          Day
```

odacli create-logcleanjob

Use the `odacli create-logcleanjob` command to create a job to purge log files for a specified time period.

File Path

```
$ORACLE_HOME/opt/oracle/dcs/bin/odacli
```

Syntax

To list jobs and view job details and status:

```
odacli create-logcleanjob [-h] [-c] [-o] [-u]
```

Parameters

Parameter	Description
--help, -h	(Optional) Displays help for using the command.
--components, -c	(Optional) Specifies the list of components, separated by comma. The values are <code>gi</code> <code>database</code> <code>dcs</code> . For example, <code>gi,dcs</code> .
--olderthan, -o	(Optional) Cleans logs older than specified time interval. Default is 30 if it is not specified.
--unit, -u	(Optional) Unit for the --olderthan parameter. Default is Day if it is not specified.

Example 14-146 Creating Jobs to Purge Logs

To create jobs to purge logs:

```
# odacli create-logcleanjob
Job details
-----
                ID: e03d90b5-41dd-45e0-8b7a-1480d6d7f86f
Description:    log file cleanup
                Status: Created
Created:       July 25, 2018 8:06:56 PM UTC
Message:

Task Name      Start Time End Time  Status
-----
# ./odacli describe-job -i e03d90b5-41dd-45e0-8b7a-1480d6d7f86f
Job details
-----
                ID: e03d90b5-41dd-45e0-8b7a-1480d6d7f86f
```

```

Description: log file cleanup

Status: Success

Created: July 25, 2018 8:06:56 PM UTC

Message:

```

```

Task Name      Start Time      End Time      Status
-----
Clean TFA logs  July 25, 2018 8:06:56 PM UTC July 25, 2018 8:06:59
PM UTC Success

Clean DCS logs  July 25, 2018 8:06:56 PM UTC July 25, 2018 8:06:56 PM
UTC Success

```

odacli describe-logcleanjob

Use the `odacli describe-logcleanjob` command to describe a log cleanup job.

File Path

```
$ORACLE_HOME/opt/oracle/dcs/bin/odacli
```

Syntax

To list jobs and view job details and status:

```
odacli describe-logcleanjob [-h]
```

Parameters

Parameter	Description
<code>--help, -h</code>	(Optional) Displays help for using the command.
<code>--jobid, -i</code>	Displays the summary of the log cleanup with the specified job ID.

Example 14-147 Displaying Log Cleanup Jobs

To display log cleanup jobs:

```

# odacli describe-logcleanjob -i e03d90b5-41dd-45e0-8b7a-1480d6d7f86f
JobId      Files Deleted  Size Freed  Component  Top Path
TimeStamp

-----
e03d90b5-41dd-45e0-8b7a-1480d6d7f86f 0 0 bytes dcs /opt/oracle/dcs/log

```

July 25, 2018 8:06:56 PM UTC

e03d90b5-41dd-45e0-8b7a-1480d6d7f86f 0 0 bytes gi /u01/app/12.2.0.1/
grid July 25, 2018 8:06:59 PM UTC

odacli list-auto-logclean-policy

Use the `odacli list-auto-logclean-policy` command to list the jobs to purge log files.

File Path

`$ORACLE_HOME/opt/oracle/dcs/bin/odacli`

Syntax

To list jobs and view job details and status:

```
odacli list-auto-logclean-policy [-h] [-c]
```

Parameters

Parameter	Description
<code>--help, -h</code>	(Optional) Displays help for using the command.
<code>--components, -c</code>	(Optional) Specifies the list of components, separated by comma. The values are <code>gi</code> <code>database</code> <code>dcs</code> For example, <code>gi,dcs</code> .

Example 14-148 Listing Jobs to Purge Logs

To list jobs to purge logs:

```
# odacli list-auto-logclean-policy
Component UsageOverPercentage freeSpaceBelowPercentage UsageOverMB
OlderThan OlderThanUnit
-----
gi          40                20
0          60                Day
database   40                20
0          60                Day
dcs        30                20
0          30                Day
```

odacli list-logcleanjobs

Use the `odacli list-logcleanjobs` command to list the jobs to purge log files.

File Path

`$ORACLE_HOME/opt/oracle/dcs/bin/odacli`

Syntax

To list jobs and view job details and status:

```
odacli list-logcleanjobs [-h]
```

Parameters

Parameter	Description
<code>--help, -h</code>	(Optional) Displays help for using the command.

Example 14-149 Listing Jobs to Purge Logs

To list jobs to purge logs:

```
# odacli list-logcleanjobs
JobId   Files Deleted   Size Freed   Component   Top Path   TimeStamp
-----
-----a8ef8315-02e8-4979-
ab1f-30251818c6eb 0   0 bytes gi   /u01/app/12.2.0.1/grid July 25, 2018
7:45:10 PM UTC

e03d90b5-41dd-45e0-8b7a-1480d6d7f86f 0 0 bytes gi   /u01/app/12.2.0.1/
grid July 25, 2018 8:06:59 PM UTC

e03d90b5-41dd-45e0-8b7a-1480d6d7f86f 0 0 bytes dcs   /opt/
oracle/dcs/log July 25, 2018 8:06:56 PM UTC
-----
```

odacli list-logspaceusage

Use the `odacli list-logspaceusage` command to display the log file usage.

File Path

`$ORACLE_HOME/opt/oracle/dcs/bin/odacli`

Syntax

To list jobs and view job details and status:

```
odacli list-logspaceusage [-c] [-h]
```

Parameters

Parameter	Description
--components, -c	Describes the list of components delimited by comma. The values can be <code>gi database dcs</code> . For example, <code>gi,dcs</code> .
--help, -h	(Optional) Displays help for using the command.

Example 14-150 Displaying a List of Logs

To display log file space usage for a list of components:

```
odacli list-logspaceusage
Timestamp: July 25, 2018 7:31:39 PM UTC

-----

Component      Size(MB)  Partition                               LogUsagePercentage
PartitionFreePercentage

-----

dcs      477.00    /dev/mapper/VolGroupSys-LogVolOpt      1.85
0.79                                         81.00

gi 1863.68    /dev/mapper/VolGroupSys-LogVolU01 1.85
86.00
```

odacli Oracle Auto Service Request Commands

Use the Oracle Auto Service Request (Oracle ASR) commands to configure, update, test, and delete Oracle ASR on the system.

- [odacli configure-asr](#)
- [odacli delete-asr](#)
- [odacli describe-asr](#)
- [odacli test-asr](#)
- [odacli update-asr](#)

odacli configure-asr

Use the `odacli configure-asr` command to configure Oracle Auto Service Request (Oracle ASR) after deploying the appliance.

File Path

`/opt/oracle/dcs/bin/odacli`

Syntax

```
odacli configure-asr -u username [-r proxyserver] [-t proxyport]
[-y proxyuser] [-s snmpversion] -i[asrip] -e [internal|external] [-j]
[-h]
```

Parameters

Parameter	Description
<code>--asrip, -i</code>	(Optional) Identifies the external Oracle ASR Manager IP address.
<code>--asrtype, -e {internal external}</code>	Defines the Oracle ASR Configuration Type. The default is internal.
<code>--help, -h</code>	(Optional) Displays help for using the command.
<code>--json, -j</code>	(Optional) Displays JSON output.
<code>--proxyport, -t</code>	(Optional) Defines the proxy server port.
<code>--proxyserver, -r</code>	(Optional) Defines the Proxy Server Address.
<code>--proxyuser, -y</code>	(Optional) Defines the proxy user name needed to authenticate the proxy server.
<code>--snmpversion, -s [V3]</code>	(Optional) Defines Simple Network Management Protocol (SNMP) Version 3.
<code>--username, -u</code>	Defines the Oracle ASR user name. The user name is the My Oracle Support user name under which the server is registered.

Usage Notes

All log files for Oracle ASR are located in the `/var/opt/asrmanager/log/` directory.

To configure an external Oracle ASR Manager, you must define the Oracle ASR Configuration Type as external (`-e external`). For example, `odacli configure-asr -e external -i 198.51.100.1`

Example 14-151 Configuring Oracle ASR with a Proxy Server

This example configures Oracle ASR for user name `scott.tiger@example.com`. A proxy server, `www-proxy.example.com`, and port 80 are defined.

```
# odacli configure-asr -u john.smith1@example.com -t 80 -r www-
proxy.example.com
```

```
Enter new 'ASR user' password:
Confirm 'ASR user' password:
```

```
Job details
```

```
-----
ID: d99559b6-d98d-4cb7-b44d-8577cab26667
Description: Configure ASR
Status: Created
Created: January 8, 2021 6:12:19 AM WSST
Message:
```

```
Task Name          Start Time          End Time          Status
-----
```

Example 14-152 Configuring an External Oracle ASR

This example configures Oracle Database Appliance to use an external Oracle ASR instance at IP address 10.20.30.40.

```
# odacli configure-asr --asrip 10.20.30.40 --asrtype External
{
  "jobId" : "ea054a2f-d18d-4253-83bc-b57434e3598e",
  "status" : "Created",
  "message" : "Please run the script '/tmp/activateExternalAssets.pl'
on the ASRManager host once the current job is successful.",
  "reports" : [ ],
  "createTimestamp" : "January 8, 2021 22:12:34 PM EST",
  "description" : "Configure ASR",
  "updatedAtTime" : "January 8, 2021 22:12:34 PM EST"
}
```

When the job completes successfully, run the `/tmp/activateExternalAssets.pl` script on the Oracle ASR Manager host.

odacli delete-asr

Use the `odacli delete-asr` command to remove the Oracle Auto Service Request (Oracle ASR) configuration from the system.

File Path

```
$ORACLE_HOME/opt/oracle/dcs/bin/odacli
```

Syntax

```
# odacli delete-asr [-h]
```

Parameters

Parameter	Description
--help, -h	(Optional) Displays help for using the command.

Example 14-153 Deleting Oracle ASR From the System

```
# odacli delete-asr
{
  "jobId" : "5d70bd17-ec4a-48da-8196-1364105db99d",
  "status" : "Running",
  "message" : null,
  "reports" : [ ],
  "createTimestamp" : 1469409622451,
  "description" : "Delete ASR",
  "updatedAtTime" : 1469409622458
}
```

odacli describe-asr

Use the `odacli describe-asr` command to display Oracle Auto Service Request (Oracle ASR) configuration details.

File Path

`$ORACLE_HOME/opt/oracle/dcs/bin/odacli`

Syntax

```
describe-asr [-h]
```

Parameters

Parameter	Description
--help, -h	(Optional) Displays help for using the command.

Example 14-154 Displaying Oracle ASR Details

```
# odacli describe-asr

ASR details
-----
ID: e841d74a-687b-4e87-9548-1baa2090d48e
Name: UserName: scott.tiger@example.com
ProvyServerName: www-proxy.example.com
ProxyPort: 80
ProxyUserName:
SnmpVersion: V3
```

State: N/A
Created: July 15, 2016 8:53:54 AM PST
Updated: July 15, 2016 8:53:54 AM PST

odacli test-asr

Use the `odacli test-asr` command to test the Oracle Auto Service Request (Oracle ASR) configuration.

File Path

`$ORACLE_HOME/opt/oracle/dcs/bin/odacli`

Syntax

```
# odacli test-asr [-h]
```

Parameters

Parameter	Description
<code>--help, -h</code>	(Optional) Displays help for using the command.

Usage Notes

This command internally invokes the SNMP test trap by invoking `/SP/alertmgmt/rules/1 testrule=true`.

Example 14-155 Testing the Oracle ASR Configuration

```
# odacli test-asr
```

Job details

```
-----
ID: ec6783f4-551d-4686-ab1b-22e2d9e59c98
Description: Test ASR
Status: Created
Created: July 25, 2016 9:03:15 AM SGT
Message:
```

```
Task Name                Start Time                End Time
Status
-----
```

odacli update-asr

Use the `odacli update-asr` command to make changes to Oracle Auto Service Request (Oracle ASR) configuration details after deploying the appliance.

File Path

`/opt/oracle/dcs/bin/odacli`

Syntax

```
update-asr -u username [-r proxyserver] [-t proxyport] [-y proxyuser] [-s snmpversion] -i[asrip] -e [internal|external] [-j] [-h]
```

Parameters

Parameter	Description
<code>--asrip, -i</code>	(Optional) Identifies the external Oracle ASR Manager IP address.
<code>--asrtype, -e [internal external]</code>	Defines the Oracle ASR Configuration Type. The default is internal.
<code>--help, -h</code>	(Optional) Displays help for using the command.
<code>--json, -j</code>	(Optional) Displays JSON output.
<code>--proxyport, -t</code>	(Optional) Defines the proxy server port.
<code>--proxyserver, -r</code>	(Optional) Defines the Proxy Server Address.
<code>--proxyuser, -y</code>	(Optional) Defines the proxy user name needed to authenticate the proxy server.
<code>--snmpversion, -s [v3]</code>	(Optional) Defines Simple Network Management Protocol (SNMP) Version 3.
<code>--username, -u</code>	Defines the Oracle ASR user name. The user name is the My Oracle Support user name under which the server is registered.

Usage Notes

- Enter the password during Oracle ASR configuration.
- All log files for Oracle ASR are located in the `/var/opt/asrmanager/log/` directory.
- You cannot use the `update-asr` command to change the Oracle ASR type. For example, from internal to external. To change the Oracle ASR type, delete the existing configuration using the `odacli delete-asr` and then re-configure Oracle ASR using the `odacli configure-asr` command.
- To configure an external Oracle ASR Manager, you must define the Oracle ASR Configuration Type as external (`-e external`). For example, `odacli update-asr -e external -i 198.51.100.1`

Example 14-156 Updating Oracle ASR with a New Proxy Server

This example updates Oracle ASR for user name `scott.tiger@example.com`. The password is not defined in the command-line. You are prompted to enter the password during configuration. The proxy server is updated to `www-proxy2.example.com`.

```
# odacli update-asr -u scott.tiger@example.com --proxyserver www-
proxy2.example.com --proxyport 80
Enter new 'ASR user' password:
Confirm 'ASR user' password:
```

Job details

```
-----
ID: 79cb2baa-1644-45c5-a004-a303e3111807
Description: Update ASR
Status: Created
Updated: January 8, 2021 9:53:54 AM PST
Message:
```

Task Name	Start Time	End Time	Status
-----------	------------	----------	--------

odacli OS Commands

Use the `odacli` OS commands to list and update operating system (OS) parameters.

- [odacli list-osconfigurations](#)
Use the command `odacli list-osconfigurations` to display the current HugePage and memlock values and view suggested values based on the total available space.
- [odacli update-osconfigurations](#)
Use the command `odacli update-osconfigurations` to update the HugePage and memlock values.

odacli list-osconfigurations

Use the command `odacli list-osconfigurations` to display the current HugePage and memlock values and view suggested values based on the total available space.

File Path

```
$ORACLE_HOME/opt/oracle/dcs/bin/odacli
```

Syntax

```
odacli list-osconfigurations [-h] [-j]
```

Parameters

Parameter	Description
--help, -h	(Optional) Displays help for using the command.
--json, -j	(Optional) Displays JSON output. The default is false.

Usage Notes

The command displays the configured values for HugePage and memlock from the `/etc/sysctl.conf` and `/etc/security/limits.conf` files. Based on the total available space, suggested values are calculated for the parameters.

Example 14-157 Displaying a List of Configured and Suggested Memlock and HugePage Configurations

```
# odacli list-osconfigurations
```

Parameter	User	ConfiguredValue	SuggestedValue
Memlock	grid	295971180KB	289034355KB
Memlock	oracle	295971180KB	289034355KB
HugeSpace	default	101430MB	101161MB

odacli update-osconfigurations

Use the command `odacli update-osconfigurations` to update the HugePage and memlock values.

File Path

`$ORACLE_HOME/opt/oracle/dcs/bin/odacli`

Syntax

```
odacli update-osconfigurations [-h] [-hs] [-j] [-m]
```

Parameters

Parameter	Description
--help, -h	(Optional) Displays help for using the command.
--hugespace, -hs	(Optional) Updates the HugePage value.

Parameter	Description
--json, -j	(Optional) Displays JSON output. The default is false.
--memlock, -m	(Optional) Updates the memlock value.

Usage Notes

The command updates memlock in the `/etc/security/limits.conf` file and HugePage in the `/etc/sysctl.conf` file with the suggested values.

You can update memlock or hugepage. If no option is provided, then both parameters are updated to the suggested values.

Example 14-158 Updating the HugePage and Memlock Parameters to the Suggested Values

```
odacli update-osconfigurations
{
  "jobId" : "954cf7a5-9cad-451c-8820-3140a716af26",
  "status" : "Created",
  "message" : "Successfully submitted a request to configure OS
parameters.",
  "reports" : [ ],
  "createTimestamp" : "February 06, 2018 00:03:51 AM MST",
  "resourceList" : [ ],
  "description" : "Configuring OS Parameter",
  "updatedAt" : "February 06, 2018 00:03:51 AM MST"
}
[root@rwsoda6s002 ~]# odacli describe-job -i
"954cf7a5-9cad-451c-8820-3140a716af26"
Job details
-----
ID: 954cf7a5-9cad-451c-8820-3140a716af26
Description: Configuring OS Parameter
Status: Success
Created: February 6, 2018 12:03:51 AM MST
Message:
Task Name          Start Time          End
Time              Status
-----
Setting up memlock. February 6, 2018 12:03:51 AM MST February 6, 2018 12:03:51 AM
MST Success
Setting up HugeSpace February 6, 2018 12:03:51 AM MST February 6, 2018 12:03:51 AM
MST Success
```

odaadmcli Hardware Monitoring Commands

Use the hardware monitoring commands to display hardware configurations.

- [odaadmcli show cooling](#)
Use the `odaadmcli show cooling` command to show cooling details.
- [odaadmcli show env_hw](#)
Use the `odaadmcli show env_hw` command to display information about the environment and hardware.
- [odaadmcli show fs](#)
Use the `odaadmcli show fs` command to display filesystem details.

- [odaadmcli show memory](#)
Use the `odaadmcli show memory` command to display memory details.
- [odaadmcli show network](#)
Use the `odaadmcli show network` command to show network details.
- [odaadmcli show power](#)
Use the `odaadmcli show power` command to display power supply details.
- [odaadmcli show processor](#)
Use the `odaadmcli show processor` command to display processor details.
- [odaadmcli show server](#)
Use the `odaadmcli show server` command to display server details.

odaadmcli show cooling

Use the `odaadmcli show cooling` command to show cooling details.

File Path

`$ORACLE_HOME/opt/oracle/dcs/bin/odaadmcli`

Syntax

To show cooling details:

```
odaadmcli show cooling [-h]
```

Parameters

Parameter	Description
<code>--help, -h</code>	(Optional) Displays help for using the command.

odaadmcli show env_hw

Use the `odaadmcli show env_hw` command to display information about the environment and hardware.

File Path

`$ORACLE_HOME/opt/oracle/dcs/bin/odaadmcli`

Syntax

To display environment and hardware details:

```
odaadmcli show env_hw [-h]
```

Parameters

Parameter	Description
<code>--help, -h</code>	(Optional) Displays help for using the command.

Example 14-159 Displaying Environment and Hardware Details

To display the hardware details, enter the command `odaadmcli show env_hw`. The results show a bare metal Oracle Database Appliance system.

```
# odaadmcli show env_hw

BM ODA_Lite X7-2 Medium
```

odaadmcli show fs

Use the `odaadmcli show fs` command to display filesystem details.

File Path

```
$ORACLE_HOME/opt/oracle/dcs/bin/odaadmcli
```

Syntax

To display filesystem details:

```
odaadmcli show fs [-h]
```

Parameters

Parameter	Description
--help, -h	(Optional) Displays help for using the command.

Example 14-160 Displaying Filesystem Details

```
# odaadmcli show fs

Type      Total Space  Free Space    Total DG Space  Free DG Space
ext3      30237M      7763M         -                -
ext3      484M        416M          -                -
ext3      60475M     38149M        -                -
ext3      100793M    22060M        -                -

acfs      102400M     102158M       4894016M        2418668M
acfs      102400M     100501M       4894016M        2418668M
acfs      102400M     100601M       4894016M        2418668M
```

(Continued)

```
Diskgroup Mount Point
          /
          /boot
          /opt
          /u01
DATA      /u02/app/oracle/oradata/ACFSDB1
DATA      /u02/app/oracle/oradata/ACFSDB2
DATA      /u02/app/oracle/oradata/EE12NCDB
```

odaadmcli show memory

Use the `odaadmcli show memory` command to display memory details.

File Path

`$ORACLE_HOME/opt/oracle/dcs/bin/odaadmcli`

Syntax

To show memory details:

```
odaadmcli show memory [-h]
```

Parameters

Parameter	Description
<code>--help, -h</code>	(Optional) Displays help for using the command.

Example 14-161 Display Memory Details

```
# odaadmcli show memory
```

```

NAME      HEALTH  HEALTH_DETAILS  PART_NO.      SERIAL_NO.
DIMM_0    OK      -                3A4K40BB1-CRC
00CE01154602EADA96
DIMM_11   OK      -                3A4K40BB1-CRC
00CE01154602EADADA
DIMM_3    OK      -                3A4K40BB1-CRC
00CE01154602EADBC7
DIMM_8    OK      -                3A4K40BB1-CRC
00CE01154602EADBA0

```

(Continued)

```

LOCATION  MANUFACTURER  MEMORY_SIZE  CURR_CLK_SPEED  ECC_Errors
P0/D0   Samsung       32 GB       2400 MHz       0
P0/D1   Samsung       32 GB       2400 MHz       0
P0/D3   Samsung       32 GB       2400 MHz       0
P0/D8   Samsung       32 GB       2400 MHz       0

```

odaadmcli show network

Use the `odaadmcli show network` command to show network details.

File Path

`$ORACLE_HOME/opt/oracle/dcs/bin/odaadmcli`

Syntax

To show network details:

```
odaadmcli show network [-h]
```

Parameters

Parameter	Description
--help, -h	(Optional) Displays help for using the command.

Example 14-162 Showing Network Details

```
# odaadmcli show network
NAME                HEALTH HEALTH_DETAILS LOCATION PART_NO MANUFACTURER
MAC_ADDRESS LINK_DETECTED DIE_TEMP

Ethernet_NIC_0      OK      -                NET0      i210      INTEL
00:10:E0:DD:9D:14  no (em1) N/A

Ethernet_NIC_1      OK      -                NET1      X710/X557-AT Intel
3C:FD:FE:78:93:92  no (p2p3) N/A

Ethernet_NIC_2      OK      -                NET2      X710/X557-AT Intel
3C:FD:FE:78:93:91  yes (p2p2) N/A

Ethernet_NIC_3      OK      -                NET3      X710/X557-AT Intel
3C:FD:FE:78:93:90  yes (p2p1) N/A

Ethernet_NIC_4      OK      -                NET4      BCM57414 Broadcom
B0:26:28:3F:D8:B8  yes (p7p2) N/A

Ethernet_NIC_5      OK      -                NET5      X710/X557-AT Intel
3C:FD:FE:78:93:93  no (p2p4) N/A

Ethernet_NIC_6      OK      -                NET6      BCM57414 Broadcom
B0:26:28:3F:D8:B0  yes (p7p1) N/A
```

odaadmcli show power

Use the `odaadmcli show power` command to display power supply details.

File Path

```
/opt/oracle/dcs/bin/odaadmcli
```

Syntax

Run this command on the first node, to display power supply details on Oracle Database Appliance High-Availability (HA) models:

```
odaadmcli show power [-h]
```

Parameters

Parameter	Description
--help, -h	(Optional) Displays help for using the command.

Example 14-163 Displaying Power Supply Details

```
# odaadmcli show power
```

```
NAME           HEALTH HEALTH_DETAILS PART_NO.   SERIAL_NO.
Power_Supply_0 OK        -          7079395   476856Z+1514CE056G
```

(Continued)

```
LOCATION    INPUT_POWER  OUTPUT_POWER  INLET_TEMP    EXHAUST_TEMP
PS0       Present      112 watts     28.000 degree C  34.938
degree C
```

odaadmcli show processor

Use the `odaadmcli show processor` command to display processor details.

File Path

```
$ORACLE_HOME/opt/oracle/dcs/bin/odaadmcli
```

Syntax

To show processor details:

```
odaadmcli show processor [-h]
```

Parameters

Parameter	Description
--help, -h	(Optional) Displays help for using the command.

Example 14-164 Displaying Processor Details

```
# odaadmcli show processor
```

```
NAME      HEALTH HEALTH_DETAILS PART_NO.  LOCATION  MODEL
CPU_0     OK      -          060F P0  (CPU 0)   Intel(R) Xeon(R)
CPU E5-2630
```

(Continued)

```
MAX_CLK_SPEED  TOTAL_CORES  ENABLED_CORES
2.200 GHz      10           10
```

odaadmcli show server

Use the `odaadmcli show server` command to display server details.

File Path

```
$ORACLE_HOME/opt/oracle/dcs/bin/odaadmcli
```

Syntax

To show server details:

```
odaadmcli show server [-h]
```

Parameters

Parameter	Description
<code>--help, -h</code>	(Optional) Displays help for using the command.

Example 14-165 Displaying Server Details

```
# odaadmcli show server

Power State : On
Open Problems : 0
Model : ORACLE SERVER X7-2
Type : Rack Mount
Part Number : 7320190
Serial Number : 1605NM10JJ
Primary OS : Not Available
ILOM Address : 10.209.8.215
ILOM MAC Address : 00:10:E0:95:98:F0
Description : Oracle Database Appliance X7-2 Small 1606NM1s02
Locator Light : Off
Actual Power Consumption : 135 watts
Ambient Temperature : 24.250 degree C
Open Problems Report : System is healthy
```

Storage Commands

Understand the commands to perform storage operations and diagnostics.

- [odaadmcli expand storage](#)
Use the `odaadmcli expand storage` command to expand storage.
- [odacli list-dgdisks](#)
Use the `odacli list-dgdisks` command to display details about the available disks.

- [odacli validate-storagetopology](#)
Use the `odacli validate-storagetopology` command to check the cable connections between the system controllers and the storage shelf, as well as the cable connection to the storage expansion shelf (if one is installed).
- [odaadmcli power disk](#)
Use the `odaadmcli power disk` command to power a disk on or off for NVMe drives only.
- [odaadmcli show controller](#)
Use the `odaadmcli show controller` command to display details of the controller.
- [odaadmcli show disk](#)
Use the `odaadmcli show disk` command to display the status of a single disk or of all disks on the system.
- [odaadmcli show diskgroup](#)
Use the `odaadmcli show diskgroup` command to list configured diskgroups or display a specific diskgroup configuration.
- [odaadmcli show raidsyncstatus](#)
Use the `odaadmcli show raidsyncstatus` command to display the RAID SYNC status.
- [odaadmcli show storage](#)
Use the `odaadmcli show storage` command to show the storage controllers, expanders, and disks.
- [odaadmcli stordiag](#)
Use the `odaadmcli stordiag` command to collect detailed information for each disk or NVMe.

odaadmcli expand storage

Use the `odaadmcli expand storage` command to expand storage.

File Path

```
/opt/oracle/dcs/bin/odaadmcli
```

Syntax

```
odaadmcli expand storage -ndisk number of disks to be added -  
enclosure {0|1} [-h]
```

Parameters

Parameter	Description
<code>--enclosure {0 1}</code>	Defines the JBOD or shelf number. The base storage shelf is 0. The storage expansion shelf is 1. This option is only available for multi-node platforms. It is not supported on Oracle Database Appliance single node platforms.

Parameter	Description
--help, -h	(Optional) Displays help for using the command.
-ndisk	Defines the number of disks to be added in the enclosure.

Usage Notes

On high-availability (HA) Oracle Database Appliance hardware models, run the command only on the first node.

Various storage options are available. On multi-node platforms, the base storage is SSD and you can choose to add either SSD or HDD disks. When adding a storage expansion shelf, all disks must be the same type (you cannot combine SSD and HDD disks).

Note:

In addition to reviewing the `expand storage` command, it is important to follow the procedures for adding storage. Cabling validation and disk placement is important. In some cases, you must move disks to different slots to successfully expand storage.

odacli list-dgdisks

Use the `odacli list-dgdisks` command to display details about the available disks.

File Path

```
/opt/oracle/dcs/bin/odacli
```

Syntax

To list available disk details:

```
odacli list-dgdisks [-h] [-dg] [-dp] [-j]
```

Parameters

Parameter	Description
--json, -j	(Optional) Displays JSON output.
--help, -h	(Optional) Displays help for using the command.
--diskgroup, -dg	(Optional) Displays all disks in the specified disk group. The possible values are: ALL, DATA, RECO, REDO, FLASH. If no value is specified, then ALL disks are displayed.

Parameter	Description
--diskpath, -dp	(Optional) Displays all disks that contains the specified value in the path. If no value is specified, then all disks are displayed.

Usage Notes

Example 14-166 Listing All Available Disks on the System

```
# odacli list-dgdisks -dg ALL
```

```
Name                               Group Mount St Group Num Mode St State
Redundancy Fail Grp                Path
Health Inc
-----
-----
-----
HDD_E0_S19_576667504P1  DATA  CACHED  1          ONLINE  NORMAL
UNKNOWN   HDD_E0_S19_576667504P1  AFD:HDD_E0_S19_576667504P1
0         0
HDD_E0_S08_577087696P1  DATA  CACHED  1          ONLINE  NORMAL
UNKNOWN   HDD_E0_S08_577087696P1  AFD:HDD_E0_S08_577087696P1
0         0
HDD_E0_S11_576021940P1  DATA  CACHED  1          ONLINE  NORMAL
UNKNOWN   HDD_E0_S11_576021940P1  AFD:HDD_E0_S11_576021940P1
0         0
HDD_E0_S13_576660012P1  DATA  CACHED  1          ONLINE  NORMAL
UNKNOWN   HDD_E0_S13_576660012P1  AFD:HDD_E0_S13_576660012P1
0         0
HDD_E0_S15_577131668P1  DATA  CACHED  1          ONLINE  NORMAL
UNKNOWN   HDD_E0_S15_577131668P1  AFD:HDD_E0_S15_577131668P1
0         0
HDD_E0_S09_576662448P1  DATA  CACHED  1          ONLINE  NORMAL
UNKNOWN   HDD_E0_S09_576662448P1  AFD:HDD_E0_S09_576662448P1
0         0
HDD_E0_S18_577136300P1  DATA  CACHED  1          ONLINE  NORMAL
UNKNOWN   HDD_E0_S18_577136300P1  AFD:HDD_E0_S18_577136300P1
0         0
```

Example 14-167 Listing Disks with the Specified Disk Path on the System

```
# odacli list-dgdisks -dp HDD_E0_S10_577135552
```

```
Name                               Group Mount St Group Num Mode St State
Redundancy Fail Grp                Path                Health Inc
-----
-----
-----
HDD_E0_S10_577135552P1  DATA  CACHED  1          ONLINE  NORMAL
UNKNOWN   HDD_E0_S10_577135552P1  AFD:HDD_E0_S10_577135552P1  0         0
HDD_E0_S10_577135552P2  RECO   CACHED  2          ONLINE  NORMAL
UNKNOWN   HDD_E0_S10_577135552P2  AFD:HDD_E0_S10_577135552P2  0         0
```

odacli validate-storagetopology

Use the `odacli validate-storagetopology` command to check the cable connections between the system controllers and the storage shelf, as well as the cable connection to the storage expansion shelf (if one is installed).

Oracle recommends that you run the `odacli validate-storagetopology` command before deploying the system to ensure that the cabling is correct. This will avoid and prevent problems during deployment due to incorrect or missing cable connections. If the cabling is not correct, you will see errors in your output.

File Path

`$ORACLE_HOME/opt/oracle/dcs/bin/odacli`

Syntax

```
odacli validate-storagetopology [-h]
```

Parameters

Parameter	Description
<code>--help, -h</code>	(Optional) Displays help for using the command.

odaadmcli power disk

Use the `odaadmcli power disk` command to power a disk on or off for NVMe drives only.

File Path

`$ORACLE_HOME/opt/oracle/dcs/bin/odaadmcli`

Syntax

To power an NVMe disk on or off:

```
odaadmcli power disk {on|off|status} disk_name [-h]
```

Parameters

Parameter	Description
<code>disk_name</code>	Defines the disk resource name. The resource name format is <code>pd_[0..3]</code> .
<code>{on off status}</code>	Power on a disk, power off a disk, display status.
<code>--help, -h</code>	(Optional) Displays help for using the command.

Example 14-168 Powering a Disk Off

This example shows how to power off a disk.

```
# odaadmcli power disk off pd_00
Disk 'pd_00' is already part of ASM

Are you sure you want to power OFF the disk?: 'pd_00'?
[yes/no]:
yes
Powered OFF pd_00
```

Example 14-169 Checking the Disk Status

This example shows how to get the status of disk pd_00.

```
# odaadmcli power disk status pd_00
The disk is powered ON
```

odaadmcli show controller

Use the `odaadmcli show controller` command to display details of the controller.

File Path

```
$ORACLE_HOME/opt/oracle/dcs/bin/odaadmcli
```

Syntax

To display details of the controller:

```
odaadmcli show controller id [-h]
```

Parameters

Parameter	Description
<code>controller_id, id</code>	Defines the controller.
<code>--help, -h</code>	(Optional) Displays help for using the command.

Example 14-170 Showing Controller Details

```
# odaadmcli show controller 1
Controller [1] information:
sun-controller-id = nvme:1b:00.00
sun-id = nvme:1b:00.00
sun-controller-manufacturer = Samsung
pci-vendor-id = 0x0000144d
sun-controller-model = 0xa821
pci-device-id = 0x0000a821
sun-controller-type = NVMe
sun-card-manufacturer = Sun Microsystems
```

```
pci-subvendor-id = 0x0000108e
sun-card-model = 0xa803
pci-subdevice-id = 0x0000a803
pci-address = 1b:00.0
sun-version-firmware = KPYA7R3Q
sun-serial-number = S2LHNAAH101008
sun-product-name = MS1PC2DD3ORA3.2T
pci-slot-number = 11
nvme-power-control = 1
sun-nac-name = /SYS/DBP/NVME1
```

odaadmcli show disk

Use the `odaadmcli show disk` command to display the status of a single disk or of all disks on the system.

File Path

```
$ORACLE_HOME/opt/oracle/dcs/bin/odaadmcli
```

Syntax

To display the status of all disks on the system:

```
odaadmcli show disk [-h]
```

To display the status of a single disk:

```
odaadmcli show disk disk_name [-h]
```

Parameters

Parameter	Description
<i>disk_name</i>	(Optional) Define the disk resource name. The resource name format is <code>pd_[0..3]</code> .
<code>--help, -h</code>	(Optional) Displays help for using the command.

Example 14-171 Displaying the Status of All Disks

To display the status of all the disks on the system:

```
# odaadmcli show disk
NAME          PATH          TYPE      STATE      STATE_DETAILS
pd_00        /dev/nvme0n1 NVD      ONLINE    Good
pd_01        /dev/nvme1n1 NVD      ONLINE    Good
```

Example 14-172 Displaying the Status of a Single Disk

To display the status of a disk named `pd_00`:

```
# odaadmcli show disk pd_00
```

```
The Resource is : pd_00
ActionTimeout : 1500
ActivePath : /dev/nvme0n1
  AsmDiskList : |data_00||reco_00|
AutoDiscovery : 1
AutoDiscoveryHi : |data:80:NVD||reco:20:NVD|
CheckInterval : 300
ColNum : 0
CriticalWarning : 0
DependListOpr : add
  Dependency : |0|
DiskId : 360025380144d5332
DiskType : NVD
Enabled : 1
ExpNum : 19
HbaPortNum : 10
IState : 0
Initialized : 0
IsConfigDepende : false
  ModelNum : MS1PC2DD3ORA3.2T
  MonitorFlag : 1
MultiPathList : |/dev/nvme0n1|
Name : pd_00
NewPartAddr : 0
OSUserType : |userType:Multiuser|
PlatformName : X7_1_LITE_S
PrevState : Invalid
PrevUsrDevName :
SectorSize : 512
SerialNum : S2LHNAAH000001
Size : 3200631791616
SlotNum : 0
SmartDiskWarnin : 0
SmartTemperatur : 37
State : Online
StateChangeTs : 1465263789
StateDetails : Good
TotalSectors : 6251233968
TypeName : 0
UsrDevName : NVD_S00_S2LHNAAH101026
VendorName : Samsung
gid : 0
  mode : 660
uid : 0
```

odaadmcli show diskgroup

Use the `odaadmcli show diskgroup` command to list configured diskgroups or display a specific diskgroup configuration.

File Path

```
$ORACLE_HOME/opt/oracle/dcs/bin/odaadmcli
```

Syntax

To list configured diskgroups:

```
odaadmcli show diskgroup [-h]
```

To display DATA configurations:

```
odaadmcli show diskgroup [DATA] [-h]
```

To display RECO configurations:

```
odaadmcli show diskgroup [RECO] [-h]
```

Parameters

Parameter	Description
DATA	(Optional) Displays the DATA diskgroup configurations.
RECO	(Optional) Displays the RECO diskgroup configurations.
--help, -h	(Optional) Displays help for using the command.

Example 14-173 Listing All Diskgroups

```
# odaadmcli show diskgroup
```

```
DiskGroups
```

```
-----
```

```
DATA
```

```
RECO
```

Example 14-174 Displaying DATA Configurations

```
# odaadmcli show diskgroup DATA
```

ASM_DISK	PATH	DISK	STATE	STATE_DETAILS
data_00	/dev/NVD_S00_S2LHNAAH101026p1	pd_00	ONLINE	Good
data_01	/dev/NVD_S01_S2LHNAAH101008p1	pd_01	ONLINE	Good

odaadmcli show raidsyncstatus

Use the `odaadmcli show raidsyncstatus` command to display the RAID SYNC status.

File Path

```
$ORACLE_HOME/opt/oracle/dcs/bin/odaadmcli
```

Syntax

To display the status of RAID SYNC:

```
odaadmcli show raidsyncstatus [-h]
```

Parameters

Parameter	Description
--help, -h	(Optional) Displays help for using the command.

Example 14-175 Displaying the RAID SYNC Status

To display the RAID SYNC details and status:

```
# odaadmcli show raidsyncstatus

Raid Type   Raid Device   Raid Status   maintainPdFailHistory   Rebuildrate
H/W Raid    /dev/sda      Optimal       ON                       30%
```

odaadmcli show storage

Use the `odaadmcli show storage` command to show the storage controllers, expanders, and disks.

File Path

```
$ORACLE_HOME/opt/oracle/dcs/bin/odaadmcli
```

Syntax

To display the storage controllers, expanders, and disks:

```
odaadmcli show storage [-h]
```

To show storage errors:

```
odaadmcli show storage -errors [-h]
```

Parameters

Parameter	Description
--errors	(Optional) Shows storage errors.
--help, -h	(Optional) Displays help for using the command.

Example 14-176 Displaying Storage Devices

The following example displays details about the storage devices on an appliance.

```
# odaadmcli show storage

==== BEGIN STORAGE DUMP =====
Host Description: Oracle Corporation:ORACLE SERVER X6-2
Total number of controllers: 2
  Id = 0
  Pci Slot = 10
  Serial Num = S2LHNAAH101026
  Vendor = Samsung
  Model = MS1PC2DD3ORA3.2T
  FwVers = KPYA7R3Q
  strId = nvme:19:00.00
  Pci Address = 19:00.0

  Id = 1
  Pci Slot = 11
  Serial Num = S2LHNAAH101008
  Vendor = Samsung
  Model = MS1PC2DD3ORA3.2T
  FwVers = KPYA7R3Q
  strId = nvme:1b:00.00
  Pci Address = 1b:00.0

Total number of expanders: 0
Total number of PDs: 2
  /dev/nvme0n1 Samsung NVD 3200gb slot: 0 pci : 19
  /dev/nvme1n1 Samsung NVD 3200gb slot: 1 pci : 1

==== END STORAGE DUMP =====
```

odaadmcli storddiag

Use the `odaadmcli storddiag` command to collect detailed information for each disk or NVMe.

File Path

```
/opt/oracle/dcs/bin/odaadmcli
```

Syntax

To collect storage diagnostics for disks and NVM Express (NVMe):

```
odaadmcli storddiag [-n] [-h]
```

Parameters

Parameter	Description
<code>-ndisk_name</code>	Defines the disk resource name. The resource name format is <code>pd_[0..3]</code> .
<code>--help, -h</code>	(Optional) Displays help for using the command.

Example 14-177 Displaying NVMe Details

To display detailed information for NVMe `pd_00`:

```
# odaadmcli storddiag pd_00
```

15

Oracle Database Appliance Command-Line Interface for KVM

Use `odacli` commands to manage Oracle Linux Kernel-based Virtual Machine (KVM) on Oracle Database Appliance.

- [About Command-Line Interface for Kernel-Based Virtual Machine \(KVM\)](#)
The `odacli` commands are the primary method for performing database and system administration on Oracle Database Appliance Kernel-Based Virtual Machine (KVM).
- [About ODACLI Commands Supported on Oracle KVM Database System](#)
Understand the `odacli` commands supported on Oracle Database Appliance Kernel-Based Virtual Machine (KVM) Database System in this release.
- [odacli Database System Commands for KVM](#)
Use the `odacli` database system commands to manage databases on Oracle Database Appliance for Oracle KVM.
- [odacli VM Storage Commands for KVM](#)
Use the `odacli` virtual machine storage commands to manage storage on Oracle Database Appliance for Oracle KVM.
- [odacli Virtual Disk Commands for Oracle KVM](#)
Use the `odacli` virtual disk commands to manage virtual disks on Oracle Database Appliance for Oracle KVM.
- [odacli CPU Pool Commands for Bare Metal and KVM](#)
Use `odacli` commands to manage resource allocations on Oracle Database Appliance for bare metal and KVM deployments.
- [odacli VM Network Commands for KVM](#)
Use the `odacli` virtual machine network commands to manage network on Oracle Database Appliance for Oracle KVM.
- [odacli Virtual Machine Commands for Oracle KVM](#)
Use the `odacli` virtual machine commands to manage virtual machines on Oracle Database Appliance for Oracle KVM.

About Command-Line Interface for Kernel-Based Virtual Machine (KVM)

The `odacli` commands are the primary method for performing database and system administration on Oracle Database Appliance Kernel-Based Virtual Machine (KVM).

You can perform the following tasks with ODACLI commands on Kernel-Based Virtual Machine (KVM):

- Manage VM instances
- Manage VM storage

- Manage virtual disks
- Manage virtual network
- Manage CPU pools

ODACLI Command Location and Path Configuration

The `odacli` command-line interface is in the following directory:

```
/opt/oracle/dcs/bin/odacli
```

Configure the `root` user account on your Oracle Database Appliance servers to have the `PATH` variable defined to search for `odacli` commands in the path `/opt/oracle/dcs/bin/odacli`.

ODACLI Syntax

Oracle Appliance Manager command-line interface commands and parameters are case-insensitive.

An `odacli` command uses the following command syntax:

```
odacli command object [options]
```

- *command* is an action you want to perform on the appliance. For example: `show`, `locate`, `apply`.
- *object* is the target or object on which the `odacli` command performs the operation. For example, you issue a command to create or configure a virtual disk, or a network, or perform other system or software administration. You can also use object abbreviations.
- *options* are optional parts of the `odacli` command. Options can consist of one or more options that extend the use of the `odacli` command carried out on an object. Options include additional information about the action that you want to perform on the object. Option names are preceded with a dash. Many options require the name of an object for the command to perform the action that you want to carry out. The help option (`-h`) is an option that is available with every command. When you include the `-h` option, you can obtain additional information about the command that you want to perform.

Oracle Appliance Manager Command-Line Interface Help

Run the following command to see the usage information for all `odacli` commands available for your Oracle Database Appliance:

```
odacli -h
```

Run the following command to see detailed help about a specific `odacli` command:

```
odacli command -h
```

Run the following command to see detailed help about a specific `odacli` command carried out on an object, and the options that are available for you to use with that object.

```
odacli command object -h
```

About ODACLI Commands Supported on Oracle KVM Database System

Understand the `odacli` commands supported on Oracle Database Appliance Kernel-Based Virtual Machine (KVM) Database System in this release.

This release of Oracle Database Appliance supports the provisioning of Oracle KVM database system through `odacli create-dbsystem` or the Browser User Interface. The following ODACLI commands are supported on Oracle KVM Database System on Oracle Database Appliance:

- `odacli ping-agent`
- `odacli list-jobs`
- `odacli describe-job`
- `odacli list-networks`
- `odacli describe-networks`
- `odacli list-networkinterfaces`
- `odacli describe-networkinterfaces`
- `odacli list-dbhomes`
- `odacli describe-dbhome`
- `odacli list-databases`
- `odacli describe-database`

Note:

No other ODACLI commands than the ones above are supported on Oracle Database Appliance KVM Database System, in this release.

odacli Database System Commands for KVM

Use the `odacli` database system commands to manage databases on Oracle Database Appliance for Oracle KVM.

- [odacli create-dbsystem](#)
Use the `odacli create-dbsystem` command to create a new database system on Oracle Database Appliance Kernel-based Virtual Machine (KVM).
- [odacli list-dbsystems](#)
Use the `odacli list-dbsystems` command to view the database systems on Oracle Database Appliance Kernel-based Virtual Machine (KVM).

- [odacli describe-dbsystem](#)
Use the `odacli describe-dbsystem` command to describe a database system on Oracle Database Appliance Kernel-based Virtual Machine (KVM).
- [odacli describe-dbsystem-image](#)
Use the `odacli describe-dbsystem-image` command to view the supported Oracle Grid Infrastructure and Oracle Database versions and the availability of the clone files and Database System KVM image in the Oracle Database Appliance system.
- [odacli start-dbsystem](#)
Use the `odacli start-dbsystem` command to start a database system on Oracle Database Appliance Kernel-based Virtual Machine (KVM).
- [odacli stop-dbsystem](#)
Use the `odacli stop-dbsystem` command to stop a database system on Oracle Database Appliance Kernel-based Virtual Machine (KVM).
- [odacli delete-dbsystem](#)
Use the `odacli delete-dbsystem` command to delete a database system on Oracle Database Appliance Kernel-based Virtual Machine (KVM).

odacli create-dbsystem

Use the `odacli create-dbsystem` command to create a new database system on Oracle Database Appliance Kernel-based Virtual Machine (KVM).

Syntax

```
odacli create-dbsystem -p json_payload_path [-j] [-h]
```

Parameters

Parameter	Description
<code>--params, -p</code>	(Mandatory) Input parameters file path for DB system creation.
<code>--json, -j</code>	(Optional) Displays output in JSON format.
<code>--help, -h</code>	(Optional) Displays help for using the command.

Example

Create a KVM database system using a JSON file for input parameters.

```
# odacli create-dbsystem -p example_system.json
```

Job details

```
-----
                ID:  fcf305c-3e75-4af4-8702-992aa15619d0
Description:  DB System example_system creation
                Status:  Created
Created:  January 5, 2021 9:28:03 AM CST
                Message:
```

```
Task Name                Start
Time                    End Time                Status
-----
```

Related Topics

- [Example JSON File to Create a High-Availability DB System](#)
Follow the JSON file example to create a JSON file to deploy a two-node DB System, with role separation, with the command `odacli create-dbssystem`.
- [Example JSON File to Create a Single-Node DB System](#)
Follow the JSON file example to create a JSON file to deploy a single-node DB System, with role separation, with the command `odacli create-dbssystem`.
- [odacli describe-dbssystem-image](#)
Use the `odacli describe-dbssystem-image` command to view the supported Oracle Grid Infrastructure and Oracle Database versions and the availability of the clone files and Database System KVM image in the Oracle Database Appliance system.

odacli list-dbsystems

Use the `odacli list-dbsystems` command to view the database systems on Oracle Database Appliance Kernel-based Virtual Machine (KVM).

Syntax

```
odacli list-dbsystems [-j] [-h]
```

Parameters

Parameter	Description
--json, -j	(Optional) Displays output in JSON format.
--help, -h	(Optional) Displays help for using the command.

Example

List the KVM database systems.

```
# odacli list-dbsystems
Name                Shape      Cores  Memory  Status
Created            Updated
-----
dbssystem1         odb4       4      32.00 GB  CONFIGURED
2020-12-08 17:39:00 CST 2020-12-08 17:39:00 CST
dbssystem2         odb2       2      16.00 GB  CREATING
2020-12-16 09:28:03 CST 2020-12-16 09:28:03 CST
```

odacli describe-dbsystem

Use the `odacli describe-dbsystem` command to describe a database system on Oracle Database Appliance Kernel-based Virtual Machine (KVM).

Syntax

```
odacli describe-dbsystem -n db_system_name [-j] [-h]
```

Parameters

Parameter	Description
<code>--name, -n</code>	(Mandatory) Describes the name of the DB system.
<code>--json, -j</code>	(Optional) Displays output in JSON format.
<code>--help, -h</code>	(Optional) Displays help for using the command.

Example

View details of a KVM database system on a single-node system.

```
# odacli describe-dbsystem -n example_system1
```

```
DB System
details
```

```
-----
```

```

                                ID: 0656fe7b-111a-4bd3-b1f0-b3832812d328
                                Name: scaoda8m018c4
                                Shape: odb2
                                Memory: 16.00 GB
                                Status: CONFIGURED
                                Created: 2021-01-19 00:07:20 UTC
                                Updated: 2021-01-19 00:39:16 UTC
```

```
CPU Pool
```

```
-----
```

```

                                Name: cpu_pool1
                                Number of cores: 2
                                Node: node1
                                Effective CPU set: 14-15,46-47
                                Online CPUs: 14, 15, 46, 47
                                Offline CPUs: NONE
```

```
VM Storage
```

```
-----
```

```

                                Disk group: DATA
                                Volume name: SC0E8DB73A
                                Volume device: /dev/asm/sc0e8db73a-250
                                Size: 200.00 GB
                                Mount Point: /u05/app/sharedrepo/example_system
```

VMs

```
-----  
Host: host_name  
VM Name: vm_name  
VM Host Name: vm_host_name  
Target State: ONLINE  
Current State: ONLINE
```

VNetworks

```
-----  
Host: vm_host_name  
VM Name: vm_name  
Public: xxx.xxx.xxx.xxx / xxx.xxx.xxx.xxx /  
ens3 / BRIDGE(pubnet)  
ASM: xxx.xxx.xxx.xxx / xxx.xxx.xxxx.xxx /  
ens4 / BRIDGE(privasm) VLAN(priv0.100)
```

Databases

```
-----  
Name: c1kdb  
Resource ID: a98ea0d7-ec75-4dd7-a6b3-f72e0b644e3f  
Unique name: c1kdb  
Database ID: 1053377603  
Domain name: domain_name  
DB Home ID: 5ea6c0a1-d2ae-4b7f-96e9-109a569cd09b  
Shape: odb1  
Version: 19.10.0.0.210119  
Edition: EE  
Type: SI  
Role: PRIMARY  
Class: OLTP  
Storage: ASM  
Redundancy:  
Target node name:  
Character set: AL32UTF8  
NLS character set:  
Language: AMERICAN  
Territory: AMERICA  
Console enabled: false  
SEHA enabled: false  
Associated networks: NONE  
Backup config ID:  
Level 0 Backup Day: sunday  
Autobackup enabled: true  
TDE enabled: true  
CDB type: true  
PDB name: pdb1  
PDB admin user: pdbadmin
```

View details of a KVM database system on a High Availability system, without InfiniBand.

```
# odacli describe-dbsystem -n example_system2
```

DB System details

```
-----
ID: 04f718f8-ddc9-4b45-8e8e-07d14165eb9c
Name: example_system2
Shape: odb2
Memory: 16.00 GB
Status: CONFIGURED
Created: 2021-01-19 10:00:08 UTC
Updated: 2021-01-19 10:04:02 UTC
```

CPU Pool

```
-----
Name: c4bfa26faa
Number of cores: 2
Node: n1
Effective CPU set: 0-1,20-21
Online CPUs: 0, 1, 20, 21
Offline CPUs: NONE

Node: n2
Effective CPU set: 0-1,20-21
Online CPUs: 0, 1, 20, 21
Offline CPUs: NONE
```

VM Storage

```
-----
Disk group: DATA
Volume name: S4BFA26FAA
Volume device: /dev/asm/s4bfa26faa-497
Size: 400.00 GB
Mount Point: /u05/app/sharedrepo/example_system
```

VMs

```
-----
Host: host1
VM Name: x4bfa26faa
VM Host Name: example_domain1
Target State: ONLINE
Current State: ONLINE

Host: host2
VM Name: y4bfa26faa
VM Host Name: example_domain2
Target State: ONLINE
Current State: ONLINE
```

VNetworks

```
-----  
Host: example_domain1  
VM Name: x4bfa26faa  
Public: xxx.xxx.xxx.xxx / xxx.xxx.xxx.xxx /  
ens3 / BRIDGE(pubnet)  
ASM: xxx.xxx.xxx.xxx / xxx.xxx.xxx.xxx / ens4 /  
BRIDGE(privasm) VLAN(icbond0.100)  
Interconnect: xxx.xxx.xxx.xxx / xxx.xxx.xxx.xxx / ens5 /  
  
Host: example_domain2  
VM Name: y4bfa26faa  
Public: xxx.xxx.xxx.xxx / xxx.xxx.xxx.xxx /  
ens3 / BRIDGE(pubnet)  
ASM: xxx.xxx.xxx.xxx / xxx.xxx.xxx.xxx /  
ens4 / BRIDGE(privasm) VLAN(icbond0.100)  
Interconnect: xxx.xxx.xxx.xxx / xxx.xxx.xxx.xxx / ens5 /
```

Databases

```
-----  
Name: flashvm  
Resource ID: 350b72f7-2351-49e7-ada3-4051af9594f0  
Unique name: flashvmU  
Database ID:  
Domain name: domain_name  
DB Home ID: 617664f6-0a16-4922-8346-9eeb3d7256ee  
Shape: odb2  
Version: 19.0.0.0  
Edition: EE  
Type: SI  
Role: PRIMARY  
Class: OLTP  
Storage: ASM  
Redundancy:  
Target node name:  
Character set: AL32UTF8  
NLS character set:  
Language: AMERICAN  
Territory: AMERICA  
Console enabled: false  
SEHA enabled: false  
Associated networks: NONE  
Backup config ID:  
Level 0 Backup Day: sunday  
Autobackup enabled: true  
TDE enabled: true  
CDB type: false  
PDB name:  
PDB admin user:
```

View details of a KVM database system on a High Availability system, with InfiniBand.

```
# odacli describe-dbsystem -n example_system3
```

DDB System details

```
          ID: 0c5280a1-3ee1-438e-ad11-1cee23de17fd
          Name: example_system3
          Shape: odb2
          Status: CONFIGURED
          Memory: 16.00 GB
          Created: 2020-12-10 02:11:11 UTC
          Updated: 2020-12-10 02:11:11 UTC
```

CPU Pool

```
          Name: ce2ab55255
          Number of cores: 2
          Node: node1
          Effective CPU set: 4-5,24-25
          Online CPUs: 4, 5, 24, 25
          Offline CPUs: NONE
```

```
          Node: node2
          Effective CPU set: 4-5,24-25
          Online CPUs: 4, 5, 24, 25
          Offline CPUs: NONE
```

VM Storage

```
          Disk group: DATA
          Volume name: SE2AB55255
          Volume device: /dev/asm/se2ab55255-187
          Size: 400.00 GB
          Mount Point: /u05/app/sharedrepo/example_system
```

VMs

```
          Host: host1
          VM Name: xe2ab55255
          VM Host Name: host_name1
          Target State: ONLINE
          Current State: ONLINE
```

```
          Host: host2
          VM Name: ye2ab55255
          VM Host Name: host_name2
          Target State: ONLINE
          Current State: ONLINE
```

VNetworks

```
Host: node1
VM Name: xe2ab55255
Public: xxx.xxx.xxx.xxx /xxx.xxx.xxx.xxx /
ens3 / BRIDGE(pubnet)
ASM: xxx.xxx.xxx.xxx / xxx.xxx.xxx.xxx /
ibbond0 / VF(90:03.5)
Interconnect: xxx.xxx.xxx.xxx / xxx.xxx.xxx.xxx /
ibbond1 / VF(90:01.7)
```

```
Host: node2
VM Name: ye2ab55255
Public: xxx.xxx.xxx.xxx / xxx.xxx.xxx.xxx /
ens3 / BRIDGE(pubnet)
ASM: xxx.xxx.xxx.xxx / xxx.xxx.xxx.xxx /
ibbond0 / VF(90:01.0)
Interconnect: xxx.xxx.xxx.xxx / xxx.xxx.xxx.xxx /
ibbond1 / VF(90:01.6)
```

Databases

```
-----
Name: datavm
Resource ID: 6aac341a-3c73-46eb-af2a-1eada9b57661
Unique name: datavmU
Database ID: 3806144946
Domain name: domain_name
DB Home ID: dcc928f1-5eb3-477b-875d-050640b7f68c
Shape: odb2
Version: 19.10.0.0.210119
Edition: EE
Type: RAC
Role: PRIMARY
Class: OLTP
Storage: ASM
Redundancy:
Target node name:
Character set: AL32UTF8
NLS character set:
Language: AMERICAN
Territory: AMERICA
Console enabled: false
SEHA enabled: false
Associated networks: NONE
Backup config ID:
Level 0 Backup Day: sunday
Autobackup enabled: true
TDE enabled: true
CDB type: false
PDB name:
PDB admin user:
```

odacli describe-dbsystem-image

Use the `odacli describe-dbsystem-image` command to view the supported Oracle Grid Infrastructure and Oracle Database versions and the availability of the clone files and Database System KVM image in the Oracle Database Appliance system.

Syntax

```
odacli describe-dbsystem-image [-j] [-h]
```

Parameters

Parameter	Description
<code>--json, -j</code>	(Optional) Displays output in JSON format.
<code>--help, -h</code>	(Optional) Displays help for using the command.

Example

View details of a KVM database system image

```
# odacli describe-dbsystem-image
DB System Image details
-----
-----
Component Name Supported Versions Available Versions
-----
DBVM           19.10.0.0.0      19.10.0.0.0
GI             19.10.0.0.210119 19.10.0.0.210119
DB            19.10.0.0.210119 19.10.0.0.210119
```

View details of a system where KVM database system image is not available

```
# odacli describe-dbsystem-image
DB System Image details
-----
-----
Component Name Supported Versions Available Versions
-----
DBVM           19.10.0.0.0      not-available
GI             19.10.0.0.210119 19.10.0.0.210119
DB            19.10.0.0.210119 19.10.0.0.210119
```

The output shows that the KVM Database System image is not yet available on the system. Download the image and run the `odacli update-repository` to import the image to the repository. The output shows that the Oracle Grid Infrastructure and Oracle Database clones are already available on the system.

odacli start-dbsystem

Use the `odacli start-dbsystem` command to start a database system on Oracle Database Appliance Kernel-based Virtual Machine (KVM).

Syntax

```
odacli start-dbsystem -n dbssystem_name [-nn node_name] [-j] [-h]
```

Parameters

Parameter	Description
--name, -n	(Mandatory) Describes the name of the DB system.
--node-name, -nn	(Optional) Specifies the bare metal system node name on which to start the DB system VM.
--json, -j	(Optional) Displays output in JSON format.
--help, -h	(Optional) Displays help for using the command.

Example

Start a KVM database system.

```
# odacli start-dbsystem -n example_system
```

Job details

```

-----
ID: 68044afa-d3cc-4024-9dc8-50fcf847642c
Description: DB System scaoda8s008c4 start
Status: Success
Created: December 16, 2020 9:12:51 AM UTC
Message:

Task Name                               Start                               Status
Time                                   End Time
-----
-----
Start DB System                         December 16, 2020 9:12:51 AM
UTC   December 16, 2020 9:12:52 AM UTC   Success

```

odacli stop-dbsystem

Use the `odacli stop-dbsystem` command to stop a database system on Oracle Database Appliance Kernel-based Virtual Machine (KVM).

Syntax

```
odacli stop-dbsystem -n dbssystem_name [-nn node_name] [-f] [-j] [-h]
```

Parameters

Parameter	Description
<code>--name, -n</code>	(Mandatory) Describes the name of the DB system.
<code>--force, -f</code>	(Optional) Forces the operation to stop the DB system.
<code>--node-name, -nn</code>	(Optional) Specifies the bare metal system node name on which to stop the DB system VM.
<code>--json, -j</code>	(Optional) Displays output in JSON format.
<code>--help, -h</code>	(Optional) Displays help for using the command.

Example

Stop a KVM database system.

```
# odacli stop-dbsystem -n example_system
```

Job details

```
-----
                ID: 68044afa-d3cc-4024-9dc8-50fcf847642c
Description:    DB System scaoda8s008c4 start
                Status: Success
                Created: December 16, 2020 9:12:51 AM UTC
                Message:

Task Name                               Start                               Status
Time                                   End Time
-----
Stop DB System                           December 16, 2020 9:12:51 AM
UTC   December 16, 2020 9:12:52 AM UTC   Success
```

odacli delete-dbsystem

Use the `odacli delete-dbsystem` command to delete a database system on Oracle Database Appliance Kernel-based Virtual Machine (KVM).

Syntax

```
odacli delete-dbsystem -n dbsystem_name [-f] [-j] [-h]
```

Parameters

Parameter	Description
<code>--name, -n</code>	(Mandatory) Describes the name of the DB system.
<code>--force, -f</code>	(Optional) Forces deletion of the DB system.
<code>--json, -j</code>	(Optional) Displays output in JSON format.
<code>--help, -h</code>	(Optional) Displays help for using the command.

! Important:

Use the DROP DATABASE statement to drop the database, and then deinstall Oracle Database and Oracle Grid Infrastructure components inside the database system before deleting the database system. See *Oracle Database Installation Guide* and *Oracle Grid Infrastructure Installation Guide* in the Oracle Database documentation library for the procedures to deinstall Oracle Database and Oracle Grid Infrastructure.

Example

Delete a KVM database system.

```
# odacli delete-dbsystem -n example_system
WARNING: please ensure GI and *all* databases within the DB system are
properly deinstalled before proceeding.
Do you confirm delete DB System 'example_system'? (Options: y/n,
default: n):
```

Job details

```
-----
ID: 4d70e75d-1bc0-4917-a50a-63cd6a108d1e
Description: DB System example_system deletion
Status: Success
Created: January 16, 2021 9:19:54 AM UTC
Message:
```

Task Name	Start	Status
Time	End Time	
-----	-----	-----
-----	-----	-----

```
# odacli describe-job -i 4d70e75d-1bc0-4917-a50a-63cd6a108d1e
```

Job details

```
-----
ID: 4d70e75d-1bc0-4917-a50a-63cd6a108d1e
Description: DB System example_system deletion
Status: Success
Created: January 16, 2021 9:19:54 AM UTC
Message:
```

Task Name	Start	Status
Time	End Time	
-----	-----	-----
-----	-----	-----
Remove DB System from Clusterware	January 16, 2021 9:19:54 AM	Success
UTC January 16, 2021 9:19:54 AM UTC		
Deprovision DB System VM(s)	January 16, 2021 9:19:54 AM	Success
UTC January 16, 2021 9:19:54 AM UTC		
Delete DB System ACFS filesystem	January 16, 2021 9:19:54 AM	

```

UTC      January 16, 2021 9:20:04 AM UTC      Success
Delete DB System ASM volume                January 16, 2021 9:20:04 AM
UTC      January 16, 2021 9:20:11 AM UTC      Success
Delete DB System VNetworks                 January 16, 2021 9:20:04 AM
UTC      January 16, 2021 9:20:11 AM UTC      Success
Delete DB System metadata                  January 16, 2021 9:20:11 AM
UTC      January 16, 2021 9:20:11 AM UTC      Success

```

odacli VM Storage Commands for KVM

Use the odacli virtual machine storage commands to manage storage on Oracle Database Appliance for Oracle KVM.

- [odacli create-vmstorage](#)
Use the `odacli create-vmstorage` command to create a new VM storage on Oracle Database Appliance Kernel-based Virtual Machine (KVM).
- [odacli list-vmstorages](#)
Use the `odacli list-vmstorages` command to list all VM storages on Oracle Database Appliance Kernel-based Virtual Machine (KVM).
- [odacli describe-vmstorage](#)
Use the `odacli describe-vmstorage` command to describe VM storage on Oracle Database Appliance Kernel-based Virtual Machine (KVM).
- [odacli modify-vmstorage](#)
Use the `odacli modify-vmstorage` command to modify VM storage configuration on Oracle Database Appliance Kernel-based Virtual Machine (KVM).
- [odacli delete-vmstorage](#)
Use the `odacli delete-vmstorage` command to delete a vmstorage configuration on Oracle Database Appliance Kernel-based Virtual Machine (KVM).

odacli create-vmstorage

Use the `odacli create-vmstorage` command to create a new VM storage on Oracle Database Appliance Kernel-based Virtual Machine (KVM).

Syntax

```
odacli create-vmstorage -n name -s size -dg disk_group [-j] [-h]
```

Parameters

Parameter	Description
<code>--name, -n</code>	Name assigned to the VM storage.
<code>--size, -s</code>	Specifies the storage size. Format is K M G T. Minimum Size is 1024M (1G)
<code>--diskgroup, -dg</code>	(Optional) Defines the ASM disk group of the VM storage (Default: DATA).
<code>--json, -j</code>	(Optional) Displays output in JSON format.
<code>--help, -h</code>	(Optional) Displays help for using the command.

Example

Create a VM storage named `share1` of 8 GB.

```
# odacli create-vmstorage -n share1 -s 8G
```

odacli list-vmstorages

Use the `odacli list-vmstorages` command to list all VM storages on Oracle Database Appliance Kernel-based Virtual Machine (KVM).

Syntax

```
odacli list-vmstorages [-j] [-h]
```

Parameters

Parameter	Description
<code>--json, -j</code>	(Optional) Displays output in JSON format.
<code>--help, -h</code>	(Optional) Displays help for using the command.

Example

```
# odacli list-vmstorages
```

odacli describe-vmstorage

Use the `odacli describe-vmstorage` command to describe VM storage on Oracle Database Appliance Kernel-based Virtual Machine (KVM).

Syntax

```
odacli describe-vmstorage -n name [-j] [-h]
```

Parameters

Parameter	Description
<code>--name, -n</code>	Specifies the name of the VM storage.
<code>--json, -j</code>	(Optional) Displays output in JSON format.
<code>--help, -h</code>	(Optional) Displays help for using the command.

Example: Describing a VM Storage named `share1`

```
# odacli describe-vmstorage -n share1
```

odacli modify-vmstorage

Use the `odacli modify-vmstorage` command to modify VM storage configuration on Oracle Database Appliance Kernel-based Virtual Machine (KVM).

Syntax

```
odacli modify-vmstorage -n name -i increment [-j] [-h]
```

Parameters

Parameter	Description
<code>--name, -n</code>	Specifies the virtual disk name
<code>--increment, -i</code>	Incremental storage size to be modified. Format is K M G T
<code>--json, -j</code>	(Optional) Displays output in JSON format.
<code>--help, -h</code>	(Optional) Displays help for using the command.

Example

Increase the size of a VM storage named `share1` by 10 gigabytes.

```
# odacli modify-vmstorage -n share1 -i 10G
```

odacli delete-vmstorage

Use the `odacli delete-vmstorage` command to delete a vmstorage configuration on Oracle Database Appliance Kernel-based Virtual Machine (KVM).

Syntax

```
odacli delete-vmstorage -n name [-f] [-j] [-h]
```

Parameters

Parameter	Description
<code>--name, -n</code>	Specifies the vmstorage name to be deleted
<code>--force, -f</code>	(Optional) Specifies the force option
<code>--json, -j</code>	(Optional) Displays output in JSON format.
<code>--help, -h</code>	(Optional) Displays help for using the command.

Example

Delete a VM storage named `share1`.

```
odacli delete-vmstorage -n share1
```

odacli Virtual Disk Commands for Oracle KVM

Use the `odacli` virtual disk commands to manage virtual disks on Oracle Database Appliance for Oracle KVM.

- [odacli create-vdisk](#)
Use the `odacli create-vdisk` command to create a new virtual disk in a VM storage on Oracle Database Appliance Kernel-based Virtual Machine (KVM).
- [odacli list-vdisks](#)
Use the `odacli list-vdisks` command to list all virtual disks on Oracle Database Appliance Kernel-based Virtual Machine (KVM).
- [odacli describe-vdisk](#)
Use the `odacli describe-vdisk` command to describe a virtual disk on Oracle Database Appliance Kernel-based Virtual Machine (KVM).
- [odacli modify-vdisk](#)
Use the `odacli modify-vdisk` command to modify a virtual disk on Oracle Database Appliance Kernel-based Virtual Machine (KVM).
- [odacli clone-vdisk](#)
Use the `odacli clone-vdisk` command to clone a virtual disk on Oracle Database Appliance Kernel-based Virtual Machine (KVM).
- [odacli delete-vdisk](#)
Use the `odacli delete-vdisk` command to delete a virtual disk on Oracle Database Appliance Kernel-based Virtual Machine (KVM).

odacli create-vdisk

Use the `odacli create-vdisk` command to create a new virtual disk in a VM storage on Oracle Database Appliance Kernel-based Virtual Machine (KVM).

Syntax

```
odacli create-vdisk -n name -vms vmstorage_name -s size -sh -sp [-j] [-h]
```

Parameters

Parameter	Description
<code>--name, -n</code>	Name assigned to the virtual disk that is unique within the name repository
<code>--vmstorage, -vms</code>	Name of the VM storage where the virtual disk will be created
<code>--size, -s</code>	Amount of storage to be assigned from the shared repository to the shared disk. The default unit is G (for gigabytes) and the minimum size is 500 M (for megabytes). Format is K M G T
<code>--shareable, -sh</code>	(Optional) Sets the option of allowing the virtual disk to be shared by more than one virtual machine (<code>shared</code>)
<code>--sparse, -sp</code>	(Optional) Creates a sparse vdisk
<code>--json, -j</code>	(Optional) Displays output in JSON format.
<code>--help, -h</code>	(Optional) Displays help for using the command.

Example

Create a 2 GB non-sparse and shareable Virtual Disk named `vdisk1` inside the VM storage `vms1`.

```
odacli create-vdisk -n vdisk1 -vms vms1 -s 2G -sh
```

odacli list-vdisks

Use the `odacli list-vdisks` command to list all virtual disks on Oracle Database Appliance Kernel-based Virtual Machine (KVM).

Syntax

```
odacli list-vdisks [-j] [-h]
```

Parameters

Parameter	Description
<code>--json, -j</code>	(Optional) Displays output in JSON format.
<code>--help, -h</code>	(Optional) Displays help for using the command.

Example

```
odacli list-vdisks
```

odacli describe-vdisk

Use the `odacli describe-vdisk` command to describe a virtual disk on Oracle Database Appliance Kernel-based Virtual Machine (KVM).

Syntax

```
odacli describe-vdisk -n name [-j] [-h]
```

Parameters

Parameter	Description
<code>--name, -n</code>	Specifies the name of the virtual disk.
<code>--json, -j</code>	(Optional) Displays output in JSON format.
<code>--help, -h</code>	(Optional) Displays help for using the command.

Example: Describing a Virtual Disk named `vdisk1`

```
odacli describe-vdisk -n vdisk1
```

odacli modify-vdisk

Use the `odacli modify-vdisk` command to modify a virtual disk on Oracle Database Appliance Kernel-based Virtual Machine (KVM).

Syntax

```
odacli modify-vdisk -n name -i [-no-s|-s] [-j] [-h]
```

Parameters

Parameter	Description
--name, -n	Specifies the virtual disk name
--increment, -i	Defines the size to increase the virtual disk. Format is <i>value units</i> , units are K M G T
--no-shareable, --no-s	(Optional) Set the Virtual Disk as non-shareable
--shareable, -s	(Optional) Set the Virtual Disk as shareable
--json, -j	(Optional) Displays output in JSON format.
--help, -h	(Optional) Displays help for using the command.

Example

Increase the size of a virtual disk named `vdisk1` by 4 gigabytes.

```
# odacli modify-vdisk -n vdisk1 -i 4G
```

odacli clone-vdisk

Use the `odacli clone-vdisk` command to clone a virtual disk on Oracle Database Appliance Kernel-based Virtual Machine (KVM).

Syntax

```
odacli clone-vdisk -n name -cn clone_name [-j] [-h]
```

Parameters

Parameter	Description
--name, -n	Specifies the virtual disk name to be cloned
--clone-name, -cn	Specifies the name of the cloned virtual disk
--json, -j	(Optional) Displays output in JSON format.
--help, -h	(Optional) Displays help for using the command.

Example

Create a clone of a virtual disk named `vdisk1`, with the name `vdisk1_clone`. The cloned disk is created on the same storage as `vdisk1`.

```
# odacli clone-vdisk -n vdisk1 -cn vdisk1_clone
```

odacli delete-vdisk

Use the `odacli delete-vdisk` command to delete a virtual disk on Oracle Database Appliance Kernel-based Virtual Machine (KVM).

Syntax

```
odacli delete-vdisk -n name [-f] [-j] [-h]
```

Parameters

Parameter	Description
<code>--name, -n</code>	Specifies the virtual disk name to be deleted
<code>--force, -f</code>	(Optional) Specifies the force option
<code>--json, -j</code>	(Optional) Displays output in JSON format.
<code>--help, -h</code>	(Optional) Displays help for using the command.

Example

Delete a virtual disk named `vdisk1`.

```
# odacli delete-vdisk -n vdisk1
```

odacli CPU Pool Commands for Bare Metal and KVM

Use `odacli` commands to manage resource allocations on Oracle Database Appliance for bare metal and KVM deployments.

CPU pools enable management of CPU resources in both bare metal and KVM environments. There are two types of CPU pools, that is, BM and VM.

Use the BM CPU pool to ensure that the database on a bare metal host runs exclusively on the CPUs specified in the CPU pool.

Use the VM CPU pools to cage and manage CPU resource allocations to workloads for virtual machines. Workloads are isolated by creating CPU pools and assigning or pinning virtual machines to a specific CPU pool. When you pin a virtual machine to a CPU pool, you ensure that the virtual machine uses CPUs in only that CPU pool.

Resources in CPU pools cannot overlap, that is, CPU pools cannot share CPUs.

- [odacli create-cpupool](#)
Use the `odacli create-cpupool` command to create a new CPU pool on Oracle Database Appliance Bare Metal or Kernel-based Virtual Machine (KVM) deployment.
- [odacli list-cpupools](#)
Use the `odacli list-cpupools` command to list all CPU Pools on Oracle Database Appliance Bare Metal or Kernel-based Virtual Machine (KVM) deployment.
- [odacli describe-cpupool](#)
Use the `odacli describe-cpupool` command to describe CPU Pools on Oracle Database Appliance Bare Metal or Kernel-based Virtual Machine (KVM) deployment.
- [odacli modify-cpupool](#)
Use the `odacli modify-cpupool` command to modify a CPU Pool configuration on Oracle Database Appliance Bare Metal or Kernel-based Virtual Machine (KVM) deployment.

- [odacli delete-cpupool](#)
Use the `odacli delete-cpupool` command to delete a CPU Pool configuration on Oracle Database Appliance Kernel-based Virtual Machine (KVM).
- [odacli list-auditrecords](#)
Use the `odacli list-auditrecords` command to list the audit records for a CPU Pool on Oracle Database Appliance Bare Metal or Kernel-based Virtual Machine (KVM) deployment.
- [odacli describe-auditrecord](#)
Use the `odacli describe-auditrecord` command to describe the audit record for a CPU Pool on Oracle Database Appliance Bare Metal or Kernel-based Virtual Machine (KVM) deployment.

odacli create-cpupool

Use the `odacli create-cpupool` command to create a new CPU pool on Oracle Database Appliance Bare Metal or Kernel-based Virtual Machine (KVM) deployment.

Syntax

```
odacli create-cpupool -n name -c {-bm|-vm} -nn node_name [-j] [-h]
```

Parameters

Parameter	Description
<code>--name, -n</code>	Specifies the CPU Pool name.
<code>--cores, -c</code>	Specifies the CPU Pool cores
<code>--bm, -bm</code>	Specifies the CPU Pool as Bare Metal
<code>--vm, -vm</code>	Specifies the CPU Pool as Virtual Machine.
<code>--node-name, -nn</code>	(Optional) Specifies the node where the CPU Pool will be created. On High-Availability deployment, if this option is not specified, then the CPU pool is created on both nodes.
<code>--json, -j</code>	(Optional) Displays output in JSON format.
<code>--help, -h</code>	(Optional) Displays help for using the command.

Usage Notes

- Attach the BM CPU pool to databases. Bare metal CPU pools can be assigned to multiple databases.
- Attach VM CPU pool VM guest machines. VM CPU pools can be assigned to multiple VMs.
- Resources in CPU pools cannot overlap, that is, CPU pools cannot share CPUs.
- After you create a BM CPU pool, you can associate this CPU pool to a database using the `create-database` or `modify-database` command.
- After you create a VM CPU pool, you can associate this CPU pool to a VM using the `create-vm` or `modify-vm` command.
- Number of cores must be an even number between 2 and the total number of available cores on the system.

Example

Create a BM CPU pool named `cpupool1` with 6 cores associated to it.

```
# odacli create-cpupool -n cpupool1 -c 6 -bm
```

Create a VM CPU pool named `cpupool2` with 6 cores associated to it.

```
# odacli create-cpupool -n cpupool2 -c 6 -vm
```

odacli list-cpupools

Use the `odacli list-cpupools` command to list all CPU Pools on Oracle Database Appliance Bare Metal or Kernel-based Virtual Machine (KVM) deployment.

Syntax

```
odacli list-cpupools [-j] [-h]
```

Parameters

Parameter	Description
<code>--json, -j</code>	(Optional) Displays output in JSON format.
<code>--help, -h</code>	(Optional) Displays help for using the command.

Example

```
# odacli list-cpupools
```

odacli describe-cpupool

Use the `odacli describe-cpupool` command to describe CPU Pools on Oracle Database Appliance Bare Metal or Kernel-based Virtual Machine (KVM) deployment.

Syntax

```
odacli describe-cpupool -n name [-j] [-h]
```

Parameters

Parameter	Description
<code>--name, -n</code>	Specifies the name of the CPU Pool.
<code>--json, -j</code>	(Optional) Displays output in JSON format.
<code>--help, -h</code>	(Optional) Displays help for using the command.

Example: Describing a CPU pool named `cpupool1`

```
# odacli describe-cpupool -n cpupool1
```

odacli modify-cpupool

Use the `odacli modify-cpupool` command to modify a CPU Pool configuration on Oracle Database Appliance Bare Metal or Kernel-based Virtual Machine (KVM) deployment.

Syntax

```
odacli modify-cpupool -n name -c cores -f -l [-j] [-h]
```

Parameters

Parameter	Description
--name, -n	Specifies the CPU Pool name
--cores, -c	Specifies the new number of CPU cores
--force, -f	(Optional) Forces the operation
--live, -l	(Optional) Applies the changes to running VMs
--json, -j	(Optional) Displays output in JSON format.
--help, -h	(Optional) Displays help for using the command.

Usage Notes

For VM CPU pool, if `--live` is not specified, then the changes are applied to the VM configuration file and will be activated next time the VM is started. If `--live` is specified, then the changes will be applied to both VM configuration file and to the running VM.

Example

Set the size of a CPU Pool `cpupool1` to 10. If `--live` is not specified, the change is applied to the VM configuration file and will be activated next time the VM is started.

```
# odacli modify-cpupool -n cpupool1 -c 10
```

odacli delete-cpupool

Use the `odacli delete-cpupool` command to delete a CPU Pool configuration on Oracle Database Appliance Kernel-based Virtual Machine (KVM).

Syntax

```
odacli delete-cpupool -n name -f [-j] [-h]
```

Parameters

Parameter	Description
--name, -n	Specifies the CPU Pool name to be deleted
--force, -f	(Optional) Forces deletion.
--json, -j	(Optional) Displays output in JSON format.
--help, -h	(Optional) Displays help for using the command.

Example

Delete a CPU pool named `cpupool1`.

```
# odacli delete-cpupool -n cpupool1
```

odacli list-auditrecords

Use the `odacli list-auditrecords` command to list the audit records for a CPU Pool on Oracle Database Appliance Bare Metal or Kernel-based Virtual Machine (KVM) deployment.

Syntax

```
odacli list-auditrecords -du dcs-username -f from_date-range -l latest -n
node_ID -ot operation_type -ou OS_username -rn resource_name -rt resource_type
-t to_date-range [-j] [-h]
```

Parameters

Parameter	Description
<code>--dcs-user, -du</code>	(Optional) Specifies the DCS user name.
<code>--from, -f</code>	(Optional) Specifies the <i>from</i> date in the date range for the CPU pool audit records.
<code>--latest, -l</code>	(Optional) Specifies the latest number of CPU pool audit records.
<code>--node-id, -n</code>	(Optional) Specifies the node ID.
<code>--op-type, -ot</code>	(Optional) Specifies the type of operation.
<code>--os-user, -ou</code>	(Optional) Specifies the operating system user.
<code>--rsc-name, -rn</code>	(Optional) Specifies the resource name.
<code>--rsc-type, -rt</code>	(Optional) Specifies the resource type.
<code>--to, -t</code>	(Optional) Specifies the <i>to</i> date in the date range for the CPU pool audit records.
<code>--json, -j</code>	(Optional) Displays output in JSON format.
<code>--help, -h</code>	(Optional) Displays help for using the command.

Example

```
# odacli list-auditrecords
ID                               Resource type      Resource
name          Operation type  DCS username      OS username
Timestamp
-----
41295d99-f263-4284-b6d9-2aff1ae0f850  BM_CPU_POOL
testbmpool          CREATE          oda-admin          root
2020-10-08 13:27:05 UTC
0f07a013-5bb4-4cd8-bd49-04dc61fcd454  BM_CPU_POOL
pool_9f74a8e9-      DELETE          oda-admin          root
2020-10-08 12:26:30 UTC
d858269b-6c28-4bc2-af71-79004f3561e6  BM_CPU_POOL
pool_9f74a8e9-      CREATE          oda-admin          root
```

```

2020-10-08 12:24:36 UTC
9d7852c1-93fb-410e-9e0c-8c0a95ed3f0c VM_CPU_POOL
pool_d48e81e4- DELETE oda-admin root
2020-10-08 12:06:45 UTC
0235cc84-9345-40bc-ac4f-7de3f63202e2 VM_CPU_POOL
pool_4fe0b4f4- DELETE oda-admin root
2020-10-08 12:06:45 UTC
762f7263-7bd9-4b12-b891-48305165bf36 VM_CPU_POOL
pool_4fe0b4f4- MODIFY oda-admin root
2020-10-08 12:06:22 UTC
0bd2a25d-2327-4918-bd47-8c00f7406f92 VM_CPU_POOL
pool_4fe0b4f4- MODIFY

```

odacli describe-auditrecord

Use the `odacli describe-auditrecord` command to describe the audit record for a CPU Pool on Oracle Database Appliance Bare Metal or Kernel-based Virtual Machine (KVM) deployment.

Syntax

```
odacli describe-auditrecord -i [-j] [-h]
```

Parameters

Parameter	Description
<code>--id, -i</code>	Describes the ID of the audit record.
<code>--json, -j</code>	(Optional) Displays output in JSON format.
<code>--help, -h</code>	(Optional) Displays help for using the command.

Example

```

# odacli describe-auditrecord -i 41295d99-f263-4284-b6d9-2aff1ae0f850
Audit Record details
-----
Event details
-----
      Record ID: 41295d99-f263-4284-b6d9-2aff1ae0f850
Record timestamp: 2020-10-08 13:27:05 UTC
      DCS username: oda-admin
      OS username: root
      Cluster ID: test_cluster-c
      Node ID: test_cluster

Resource/Operation
-----
      Resource type: BM_CPU_POOL
      Resource ID: b17cb623-bf79-491f-86d8-d8502987e26c
      Resource name: testbmpool
      Operation type: CREATE
      Operation description: Created with '2' cores and allocation
'test_cluster:1-2,17-18'

```

odacli VM Network Commands for KVM

Use the odacli virtual machine network commands to manage network on Oracle Database Appliance for Oracle KVM.

- [odacli create-vnetwork](#)
Use the `odacli create-vnetwork` command to create a new network on Oracle Database Appliance Kernel-based Virtual Machine (KVM).
- [odacli list-vnetworks](#)
Use the `odacli list-vnetworks` command to list all virtual networks on Oracle Database Appliance Kernel-based Virtual Machine (KVM).
- [odacli describe-vnetwork](#)
Use the `odacli describe-vnetwork` command to describe virtual networks on Oracle Database Appliance Kernel-based Virtual Machine (KVM).
- [odacli start-vnetwork](#)
Use the `odacli start-vnetwork` command to start a virtual network on Oracle Database Appliance Kernel-based Virtual Machine (KVM).
- [odacli stop-vnetwork](#)
Use the `odacli stop-vnetwork` command to stop a virtual network on Oracle Database Appliance Kernel-based Virtual Machine (KVM).
- [odacli modify-vnetwork](#)
Use the `odacli modify-vnetwork` command to modify a network on Oracle Database Appliance Kernel-based Virtual Machine (KVM).
- [odacli delete-vnetwork](#)
Use the `odacli delete-vnetwork` command to delete a virtual network configuration on Oracle Database Appliance Kernel-based Virtual Machine (KVM).

odacli create-vnetwork

Use the `odacli create-vnetwork` command to create a new network on Oracle Database Appliance Kernel-based Virtual Machine (KVM).

Syntax

```
odacli create-vnetwork -n name -if interface-name -t type -br bridge -g gateway
-ip IP-address -nm netmask -u uniform -vlan VLAN-network ID [-j] [-h]
```

Parameters

Parameter	Description
<code>--name, -n</code>	Specifies the virtual network name.
<code>--interface-name, -if</code>	Specifies the the network interface on the host. This can be physical interface or bonded interface.
<code>--type, -t</code>	Specifies the virtual network type. Values are bridged or bridged-vlan.
<code>--bridge, -br</code>	(Optional) Specifies the name of the bridge.
<code>--gateway, -gw</code>	(Optional) Specifies the virtual network gateway

Parameter	Description
--ip, -ip	(Optional) Specifies the virtual network addresses. For more than one address, use the format " <i>node0_ip,node1_ip,...</i> "
--netmask, -nm	(Optional) Specifies the virtual network netmask
--uniform, -u	(Optional) Specifies whether the virtual network is created on both nodes in a high-availability deployment
--vlan-id, -vlan	(Optional) Specifies the VLAN network ID
--json, -j	(Optional) Displays output in JSON format.
--help, -h	(Optional) Displays help for using the command.

Usage Notes

If you did not specify the IP address, or netmask, or gateway during vnetwork creation, then you can add them later using the `odacli modify-vnetwork` command.

Example

Create a VM network of type `bridged` using the interface `btbond2`.

```
# odacli create-vnetwork -n vnet1 -if btbond2 -type bridged
```

odacli list-vnetworks

Use the `odacli list-vnetworks` command to list all virtual networks on Oracle Database Appliance Kernel-based Virtual Machine (KVM).

Syntax

```
odacli list-vnetworks [-j] [-h]
```

Parameters

Parameter	Description
--json, -j	(Optional) Displays output in JSON format.
--help, -h	(Optional) Displays help for using the command.

Example

```
# odacli list-vnetworks
```

odacli describe-vnetwork

Use the `odacli describe-vnetwork` command to describe virtual networks on Oracle Database Appliance Kernel-based Virtual Machine (KVM).

Syntax

```
odacli describe-vnetwork -n [-j] [-h]
```

Parameters

Parameter	Description
--name, -n	Specifies the name of the virtual network.
--json, -j	(Optional) Displays output in JSON format.
--help, -h	(Optional) Displays help for using the command.

Example: Describing a VM Network named vnet1

```
# odacli describe-vnetwork -n vnet1
```

odacli start-vnetwork

Use the `odacli start-vnetwork` command to start a virtual network on Oracle Database Appliance Kernel-based Virtual Machine (KVM).

Syntax

```
odacli start-vnetwork -n name [-j] [-h]
```

Parameters

Parameter	Description
--name, -n	Specifies the virtual machine name to be stopped
--json, -j	(Optional) Displays output in JSON format.
--help, -h	(Optional) Displays help for using the command.

Example

Start a virtual network named `vnet1`.

```
# odacli start-vnetwork -n vnet1
```

odacli stop-vnetwork

Use the `odacli stop-vnetwork` command to stop a virtual network on Oracle Database Appliance Kernel-based Virtual Machine (KVM).

Syntax

```
odacli stop-vnetwork -n name [-j] [-h]
```

Parameters

Parameter	Description
--name, -n	Specifies the virtual network to be stopped
--json, -j	(Optional) Displays output in JSON format.
--help, -h	(Optional) Displays help for using the command.

Example

Stop a virtual network named `vnet1`.

```
# odacli stop-vnetwork -n vnet1
```

odacli modify-vnetwork

Use the `odacli modify-vnetwork` command to modify a network on Oracle Database Appliance Kernel-based Virtual Machine (KVM).

Syntax

```
odacli modify-vnetwork -n name -if -t -br -gw -ip -nm -u -vlan [-j] [-h]
```

Parameters

Parameter	Description
<code>--name, -n</code>	Specifies the virtual network name.
<code>--gateway, -gw</code>	(Optional) Specifies the virtual network gateway
<code>--ip, -ip</code>	(Optional) Specifies the virtual network addresses. For more than one address, use the format " <i>node0_ip,node1_ip,...</i> "
<code>--netmask, -nm</code>	(Optional) Specifies the virtual network netmask
<code>--json, -j</code>	(Optional) Displays output in JSON format.
<code>--help, -h</code>	(Optional) Displays help for using the command.

Example

Modify a VM network to specify the gateway.

```
# odacli modify-vnetwork -n vnet1 -g 10.11.44.41
```

odacli delete-vnetwork

Use the `odacli delete-vnetwork` command to delete a virtual network configuration on Oracle Database Appliance Kernel-based Virtual Machine (KVM).

Syntax

```
odacli delete-vnetwork -n name [-j] [-h]
```

Parameters

Parameter	Description
<code>--name, -n</code>	Specifies the vnetwork name to be deleted
<code>--json, -j</code>	(Optional) Displays output in JSON format.
<code>--help, -h</code>	(Optional) Displays help for using the command.

Example

Delete a VM network named `vnet1`.

```
# odacli delete-vnetwork -n vnet1
```

odacli Virtual Machine Commands for Oracle KVM

Use the `odacli` virtual machine commands to manage virtual machines on Oracle Database Appliance for Oracle KVM.

- [odacli create-vm](#)
Use the `odacli create-vm` command to create a new virtual machine on Oracle Database Appliance Kernel-based Virtual Machine (KVM).
- [odacli list-vm](#)
Use the `odacli list-vm` command to list all virtual machines on Oracle Database Appliance Kernel-based Virtual Machine (KVM).
- [odacli describe-vm](#)
Use the `odacli describe-vm` command to describe a virtual machine on Oracle Database Appliance Kernel-based Virtual Machine (KVM).
- [odacli modify-vm](#)
Use the `odacli modify-vm` command to modify a virtual machine on Oracle Database Appliance Kernel-based Virtual Machine (KVM).
- [odacli start-vm](#)
Use the `odacli start-vm` command to start a virtual machine on Oracle Database Appliance Kernel-based Virtual Machine (KVM).
- [odacli stop-vm](#)
Use the `odacli stop-vm` command to stop a virtual machine on Oracle Database Appliance Kernel-based Virtual Machine (KVM).
- [odacli migrate-vm](#)
Use the `odacli migrate-vm` command to migrate a virtual machine on Oracle Database Appliance Kernel-based Virtual Machine (KVM).
- [odacli clone-vm](#)
Use the `odacli clone-vm` command to clone a virtual machine configuration on Oracle Database Appliance Kernel-based Virtual Machine (KVM).
- [odacli delete-vm](#)
Use the `odacli delete-vm` command to delete a virtual machine configuration on Oracle Database Appliance Kernel-based Virtual Machine (KVM).

odacli create-vm

Use the `odacli create-vm` command to create a new virtual machine on Oracle Database Appliance Kernel-based Virtual Machine (KVM).

Syntax

```
odacli create-vm -n name -m memory -src source -vc vcpus -vms vmstorage -cp  
cpupool -d description -g graphics  
-mm max-mem-size -mvc max-vcpu-count -ost os-type -osv os_variant -pn
```

```
preferred_node -s disk_size -vd vdisks
-vn virtual_networks [-j] [-h]
```

Parameters

Parameter	Description
--name, -n	Specifies the VM name
--memory, -st	Specifies the size of the VM memory. The format is "value_unit". Unit is M G.
--source, -src	Specifies the source installation. If local, it can be an ISO or a bootable disk image. If remote, it can be an URI pointing to an install tree hosted remotely over HTTP, HTTPS, FTP or NFS.
--vcpus, -vc	Specifies the number of vCPUs to use.
--vmstorage, -vms	Specifies the VM storage name
--cpupool, -cp	(Optional) Specifies the CPU pool name
--description, -d	(Optional) Specifies the VM description
--extra-args, -ea	(Optional) Specifies the extra arguments for the VM installer.
--graphics, -g	(Optional) Specifies the graphics settings for the VM
--max-memory, -mm	(Optional) Specifies the maximum size of the VM memory. The format is "value_unit". Unit is M G.
--max-vcpus, -mvc	(Optional) Specifies the maximum number of VCPUs
--os-type, -ost	(Optional) Specifies the operating system type
--os-variant, -osv	(Optional) Specifies the operating system variant
--pref-node, -pn	(Optional) Specifies the preferred node to run the VM
--size, -s	(Optional) Specifies the size of the VM. The format is "value_unit". Unit is K M G T.
--vdisks, -vd	(Optional) Specifies the names of the vdisks to use
--vnetworks, -vn	(Optional) Specifies the names of the virtual networks to use
--json, -j	(Optional) Displays output in JSON format.
--help, -h	(Optional) Displays help for using the command.

Usage Notes

Use the `--extra-args` parameter to add kickstart configuration file, kernel parameters for example, serial console. For example: `--extra-args "console=tty0 console=ttyS0,115200 ks=http://192.168.122.100:80/ks.txt"`

Example

Create a VM named `vm1` with 8 vcpus and 8 GB memory. The VM is stored in the VM Storage `vms1`. The source used for the installation is located on `/u01/OL7.iso`.

```
# odacli create-vm -n vm1 -vc 8 -m 8G -vms vs1 -src /u01/OL7.iso
```

odacli list-vms

Use the `odacli list-vms` command to list all virtual machines on Oracle Database Appliance Kernel-based Virtual Machine (KVM).

Syntax

```
odacli list-vms [-j] [-h]
```

Parameters

Parameter	Description
<code>--json, -j</code>	(Optional) Displays output in JSON format.
<code>--help, -h</code>	(Optional) Displays help for using the command.

Example

```
# odacli list-vms
```

odacli describe-vm

Use the `odacli describe-vm` command to describe a virtual machine on Oracle Database Appliance Kernel-based Virtual Machine (KVM).

Syntax

```
odacli describe-vm -n name [-j] [-h]
```

Parameters

Parameter	Description
<code>--name, -n</code>	Specifies the name of the virtual machine.
<code>--json, -j</code>	(Optional) Displays output in JSON format.
<code>--help, -h</code>	(Optional) Displays help for using the command.

Example: Describing a Virtual Machine named `vm1`

```
# odacli describe-vm -n vm1
```

odacli modify-vm

Use the `odacli modify-vm` command to modify a virtual machine on Oracle Database Appliance Kernel-based Virtual Machine (KVM).

Syntax

```
odacli modify-vm -n name -as -b boot_option -cfg -avd attach_vdisks -avn  
attach_vnetworks -d description -dvd detach-vdisk -dvn detach-vnetworks -mmm max-  
memory -mvc max-vcpus -m memory -no-cp -pn preferred-node -vc vcpu -di disk-  
increment [-j] [-h]
```

Parameters

Parameter	Description
--name, -n	Specifies the VM name
--autostart, -as	(Optional) Specifies if the auto-start option must be set for the VM
--no-autostart, -no-as	(Optional) Disables the auto-start option for the VM
--boot-option, -bo	(Optional) Specifies the the boot option to use
--config, -cfg	(Optional) Specifies whether the changes persist.
--live, -l	(Optional) Indicates whether the specified changes take place live (true) or after the next boot (false). Default is false
--cpu-pool, -cp	(Optional) Specifies the CPU pool name
--description, -d	(Optional) Specifies the VM description
--failover, -fo	(Optional) Specifies the configuration for the failover
--no-failover, -no-fo	(Optional) Specifies the configuration for the failover
--vcpus, -vc	(Optional) Specifies the number of vCPUs.
--memory, -m	(Optional) Specifies the memory size of the VM. The format is "value_unit". Unit is M G.
--max-memory, -mm	(Optional) Specifies the maximum memory size of the VM. The format is "value_unit". Unit is M G.
--max-vcpus, -mvc	(Optional) Specifies the maximum number of vCPUs.
--no-cpupool, -no-cp	(Optional) Dissociates the associated CPU Pool
--detach-vdisk, -dvd	(Optional) Specifies the names of the virtual disks to detach
--detach-vnetworks, -dvn	(Optional) Specifies the names of the virtual networks to detach
--pref-node, -pn	(Optional) Specifies the preferred node to run the VM
--disk-increment, -di	Specifies the change in size of the VM. The format is "value_unit". Unit is K M G T.
--attach-vdisks, -avd	(Optional) Specifies the names of the vdisks to attach
--attach-vnetworks, -avn	(Optional) Specifies the names of the virtual networks to attach
--json, -j	(Optional) Displays output in JSON format.
--help, -h	(Optional) Displays help for using the command.

Usage Tips

- `--live`: The change is applied to the running VM instance, but does not persist after the VM stops.
- `--config`: The change persists in the configuration of VM instance and takes effect on subsequent reboots.
- If neither `--live` or `--config` is specified, then the default behavior is `--config`.
- You can specify both the `--live` or `--config` options if you want the modification to take effect immediately and on subsequent boots.

Example

Update the configuration of a VM named `vm1`, setting the CPU count to 2 and the maximum memory to 2 gigabytes on both the running VM and subsequent boots.

```
# odacli modify-vm -n vm1 -vc 6 -mm 6G --live --config
```

odacli start-vm

Use the `odacli start-vm` command to start a virtual machine on Oracle Database Appliance Kernel-based Virtual Machine (KVM).

Syntax

```
odacli start-vm -n name -nn [-j] [-h]
```

Parameters

Parameter	Description
<code>--name, -n</code>	Specifies the virtual machine name to be stopped
<code>--node-name, -nn</code>	(Optional) Specifies the node name where the virtual machine will be started
<code>--json, -j</code>	(Optional) Displays output in JSON format.
<code>--help, -h</code>	(Optional) Displays help for using the command.

Usage Notes

- If `pref-node` is defined for the VM, then the VM starts on the `pref-node`. If `pref-node` is not defined for the VM, then the VM can start on any node, in a high-availability deployment.
- If you specify the node name `-n`, then the VM starts on the specified node, even if the preferred node is defined.

Example

Start a virtual machine named `vm1`.

```
# odacli start-vm -n vm1
```

odacli stop-vm

Use the `odacli stop-vm` command to stop a virtual machine on Oracle Database Appliance Kernel-based Virtual Machine (KVM).

Syntax

```
odacli stop-vm -n name [-f] [-j] [-h]
```

Parameters

Parameter	Description
<code>--name, -n</code>	Specifies the virtual machine name to be stopped

Parameter	Description
<code>--force, -f</code>	(Optional) Specifies the force option
<code>--json, -j</code>	(Optional) Displays output in JSON format.
<code>--help, -h</code>	(Optional) Displays help for using the command.

Example

Stop a virtual machine named `vm1`.

```
# odacli stop-vm -n vm1
```

odacli migrate-vm

Use the `odacli migrate-vm` command to migrate a virtual machine on Oracle Database Appliance Kernel-based Virtual Machine (KVM).

Syntax

```
odacli migrate-vm -n name -to node [-j] [-h]
```

Parameters

Parameter	Description
<code>--name, -n</code>	Specifies the virtual machine name to be migrated
<code>--target-node, -to</code>	Specifies the destination node
<code>--json, -j</code>	(Optional) Displays output in JSON format.
<code>--help, -h</code>	(Optional) Displays help for using the command.

Example

Migrate a virtual machine named `vm1` to node `n1`.

```
odacli migrate-vm -n vm1 -to n1
```

odacli clone-vm

Use the `odacli clone-vm` command to clone a virtual machine configuration on Oracle Database Appliance Kernel-based Virtual Machine (KVM).

Syntax

```
# odacli clone-vm -n name_of_vm_to_clone_from -cn clone_name [-j] [-h]
```

Parameters

Parameter	Description
<code>--name, -n</code>	Specifies the virtual machine name to be cloned
<code>--clone-name, -cn</code>	Specifies the name of the cloned virtual machine
<code>--description, -d</code>	(Optional) Specifies the description of the virtual machine

Parameter	Description
<code>--json, -j</code>	(Optional) Displays output in JSON format.
<code>--help, -h</code>	(Optional) Displays help for using the command.

Example

Create a clone of a virtual machine named `vm1`, with the name `vm1_clone`. The cloned VM is created on the same storage as `vm1`.

```
# odacli clone-vm -n vm1 -cn vm1_clone
```

odacli delete-vm

Use the `odacli delete-vm` command to delete a virtual machine configuration on Oracle Database Appliance Kernel-based Virtual Machine (KVM).

Syntax

```
odacli delete-vm -n name [-f] [-j] [-h]
```

Parameters

Parameter	Description
<code>--name, -n</code>	Specifies the virtual machine name to be deleted
<code>--force, -f</code>	(Optional) Specifies the force option
<code>--json, -j</code>	(Optional) Displays output in JSON format.
<code>--help, -h</code>	(Optional) Displays help for using the command.

Example

Delete a virtual machine named `vm1`.

```
odacli delete-vm -n vm1
```

16

Troubleshooting Oracle Database Appliance

Understand tools you can use to validate changes and troubleshoot Oracle Database Appliance problems.

- [Resolving Errors When Updating DCS Components During Patching](#)
Understand how to troubleshoot errors when updating DCS components during patching.
- [Viewing Component Information on the Appliance](#)
View details of all the components installed on the appliance, and the RPM drift information.
- [Errors When Logging into the Browser User Interface](#)
If you have problems logging into the Browser User Interface, then it may be due to your browser or credentials.
- [Errors when re-imaging Oracle Database Appliance](#)
Understand how to troubleshoot errors that occur when re-imaging Oracle Database Appliance.
- [Using Oracle Autonomous Health Framework for Running Diagnostics](#)
Oracle Autonomous Health Framework collects and analyzes diagnostic data collected, and proactively identifies issues before they affect the health of your system.
- [Running the Disk Diagnostic Tool](#)
Use the Disk Diagnostic Tool to help identify the cause of disk problems.
- [Running the Oracle Database Appliance Hardware Monitoring Tool](#)
The Oracle Database Appliance Hardware Monitoring Tool displays the status of different hardware components in Oracle Database Appliance server.
- [Configuring a Trusted SSL Certificate for Oracle Database Appliance](#)
The Browser User Interface and DCS Controller use SSL-based HTTPS protocol for secure communication. Understand the implications of this added security and the options to configure SSL certificates.
- [Disabling the Browser User Interface](#)
You can also disable the Browser User Interface. Disabling the Browser User Interface means you can only manage your appliance through the command-line interface.
- [Preparing Log Files for Oracle Support Services](#)
If you have a system fault that requires help from Oracle Support Services, then you may need to provide log records to help Oracle support diagnose your issue.

Resolving Errors When Updating DCS Components During Patching

Understand how to troubleshoot errors when updating DCS components during patching.

About DCS Components

When you run the `odacli update-dcscomponents` command during patching, pre-checks for MySQL installation are automatically verified before update of Zookeeper, MySQL, and DCS components. If any of the pre-checks fail, then the command errors out with a reference to the pre-check report log file location `/opt/oracle/dcs/log/jobId-dcscomponentsPreCheckReport.log`. Review the pre-check report and take corrective actions and then rerun the `odacli update-dcscomponents` command. If there are no pre-check errors, then the patching process proceeds with updating Zookeeper, MySQL, and DCS components such as the DCS Agent, DCS CLI, and DCS Controller.

Note:

Run the `odacli update-dcsadmin` command prior to running the `odacli update-dcscomponents` command.

When the `odacli update-dcscomponents` command completes successfully:

The command output is as follows:

```
# ./odacli update-dcscomponents -v 19.10.0.0.0
{
  "jobId" : "3ac3667a-fa22-40b6-a832-504a56aa3fdc",
  "status" : "Success",
  "message" : "Update-dcscomponents is successful on all the
node(s):DCS-Agent
shutdown is successful. MySQL upgrade is done before. Metadata
migration is
successful. Agent rpm upgrade is successful. DCS-CLI rpm upgrade is
successful.
DCS-Controller rpm upgrade is succ",
  "reports" : null,
  "createTimestamp" : "February 22, 2021 02:37:37 AM CST",
  "description" : "Update-dcscomponents job completed and is not part
of Agent
job list",
  "updatedAt" : "February 22, 2021 02:39:10 AM CST"
}
```

The pre-check report log file at the location `/opt/oracle/dcs/log/jobId-dcscomponentsPreCheckReport.log` contains the following:

```
Pre-check Name: Space check
Status: Success
Comments: Required space 3 GB is available in /opt

Pre-check Name: Port check
Status: Success
Comments: Port 3306 is available for running ODA MySQL

Pre-check Name: ODA MySQL rpm installation dry-run check
Status: Success
Comments: ODA MySQL rpm dry-run passed

Pre-check Name: Check for the existence of MySQL connector/J library
Status: Success
Comments: ODA MySQL connector/J library found

Pre-check Name: Check for the existence of Metadata migration utility
Status: Success
Comments: Metadata migration utility found
```

When the `odacli update-dcscomponents` command fails:

On Oracle Database Appliance single-node systems, the command output is as follows:

```
# ./odacli update-dcscomponents -v 19.10.0.0.0

DCS-10008:Failed to update DCScomponents: 19.10.0.0.0
Internal error while patching the DCS components :
DCS-10231:Cannot proceed. Pre-checks for update-dcscomponents failed.
Refer to
/opt/oracle/dcs/log/jobId-dcscomponentsPreCheckReport.log
on node 0 for details.
```

On Oracle Database Appliance high-availability systems, the command output is as follows:

```
# ./odacli update-dcscomponents -v 19.10.0.0.0

Internal error while patching the DCS components :
DCS-10231:Cannot proceed. Pre-checks for update-dcscomponents failed.
Refer to
/opt/oracle/dcs/log/jobId-dcscomponentsPreCheckReport.log
on node 0 and /opt/oracle/dcs/log/jobId-dcscomponentsPreCheckReport.log
on node 1 for details.
```

The command runs all pre-checks one by one, and errors out at the end if any of the pre-checks is marked as Failed. When a pre-check fails, the error message is displayed on to the console along with the reference to pre-check report log

location. The pre-check report log file is at the location `/opt/oracle/dcs/log/jobId-dcscomponentsPreCheckReport.log`.

Pre-check Name: Space check
Status: Failed
Comments: Available space in `/opt` is 2 GB but minimum required space in `/opt` is 3 GB

Pre-check Name: Port check
Status: Success
Comments: Port 3306 is available for running ODA MySQL

Pre-check Name: ODA MySQL rpm installation dry-run check
Status: Success
Comments: ODA MySQL rpm dry-run passed

Pre-check Name: Check for the existence of MySQL connector/J library
Status: Success
Comments: ODA MySQL connector/J library found

Pre-check Name: Check for the existence of Metadata migration utility
Status: Success
Comments: Metadata migration utility found

When the `odacli update-dcscomponents` command fails due to space check error:

The pre-check report log contains the following:

Pre-check Name: Space check
Status: Failed
Comments: Available space in `/opt` is 2 GB but minimum required space in `/opt` is 3 GB

Pre-check Name: Port check
Status: Success
Comments: Port 3306 is available for running ODA MySQL

Pre-check Name: ODA MySQL rpm installation dry-run check
Status: Success
Comments: ODA MySQL rpm dry-run passed

Pre-check Name: Check for the existence of MySQL connector/J library
Status: Success
Comments: ODA MySQL connector/J library found

Pre-check Name: Check for the existence of Metadata migration utility
Status: Success
Comments: Metadata migration utility found

When the `odacli update-dcscomponents` command fails due to port check error:

The pre-check report log contains the following:

Pre-check Name: Space check

Status: Success

Comments: Required space 3 GB is available in /opt

Pre-check Name: Port check

Status: Failed

Comments: No port found in the range (3306 to 65535)

Pre-check Name: ODA MySQL rpm installation dry-run check

Status: Success

Comments: ODA MySQL rpm dry-run passed

Pre-check Name: Check for the existence of MySQL connector/J library

Status: Success

Comments: ODA MySQL connector/J library found

Pre-check Name: Check for the existence of Metadata migration utility

Status: Success

Comments: Metadata migration utility found

When the `odacli update-dcscomponents` command fails due to MySQL RPM installation dry-run check error:

The pre-check report log contains the following:

Pre-check Name: Space check

Status: Success

Comments: Required space 3 GB is available in /opt

Pre-check Name: Port check

Status: Success

Comments: Port 3306 is available for running ODA MySQL

Pre-check Name: ODA MySQL rpm installation dry-run check

Status: Failed

Comments: ODA MySQL rpm dry-run failed. Failed due to the following error :

Exception details are displayed below

Pre-check Name: Check for the existence of MySQL connector/J library

Status: Success

Comments: ODA MySQL connector/J library found

Pre-check Name: Check for the existence of Metadata migration utility

Status: Success

Comments: Metadata migration utility found

When the `odacli update-dcscomponents` command fails due to MySQL connector/J library check error:

The pre-check report log contains the following:

```
Pre-check Name: Space check
Status: Success
Comments: Required space 3 GB is available in /opt

Pre-check Name: Port check
Status: Success
Comments: Port 3306 is available for running ODA MySQL

Pre-check Name: ODA MySQL rpm installation dry-run check
Status: Success
Comments: ODA MySQL rpm dry-run passed

Pre-check Name: Check for the existence of MySQL connector/J library
Status: Failed
Comments: MySQL connector/J library does not exist. Ensure update-
repository with latest serverzip bundles ran first without any issues
prior to running update-dcscomponents

Pre-check Name: Check for the existence of Metadata migration utility
Status: Success
Comments: Metadata migration utility found
```

When the `odacli update-dcscomponents` command fails due to Metadata migration utility check error:

The pre-check report log contains the following:

```
Pre-check Name: Space check
Status: Success
Comments: Required space 3 GB is available in /opt

Pre-check Name: Port check
Status: Success
Comments: Port 3306 is available for running ODA MySQL

Pre-check Name: ODA MySQL rpm installation dry-run check
Status: Success
Comments: ODA MySQL rpm dry-run passed

Pre-check Name: Check for the existence of MySQL connector/J library
Status: Success
Comments: ODA MySQL connector/J library found

Pre-check Name: Check for the existence of Metadata migration utility
Status: Failed
Comments: Metadata migration utility does not exist. Ensure update-
repository with latest serverzip bundles ran first without any issues
prior to running update-dcscomponents
```

Related Topics

- [Patching Oracle Database Appliance Bare Metal Systems Using the Command-Line](#)
Follow these steps to apply patches to your Oracle Database Appliance bare metal deployment and existing Oracle Database homes, using CLI commands.

Viewing Component Information on the Appliance

View details of all the components installed on the appliance, and the RPM drift information.

Viewing the Bill of Materials in the Browser User Interface

Use the Appliance tab in the Browser User Interface to view information about your deployment and the installed components. The Advanced Information tab displays information about the following components:

- Grid Infrastructure Version, and the home directory
- Database Version, Home location, and Edition
- Location and details about the databases configured
- All patches applied to the appliance
- Firmware Controller and Disks
- ILOM information
- BIOS version
- List of RPMs

In the List of RPMs section, click **Show** and then click **RPM Drift** to view the differences between the RPMs installed on the appliance, and the RPMs shipped in the latest Oracle Database Appliance Patch Bundle Update release.

Click **Download** to save the components report. You can use this report to help diagnose any deployment issues.

Viewing the Bill of Materials from the Command Line

The bill of materials is also available through the command line for bare metal and virtualized platforms deployments. The information about the installed components is collected according to a set schedule, and stored in the location `/opt/oracle/dcs/Inventory/` for bare metal deployments and in the `/opt/oracle/oak/Inventory/` directory for virtualized platforms. The file is stored in the format `oda_bom_TimeStamp.json`. Use the command `describe-system` to view the bill of materials on the command line. See the *Oracle Database Command-Line Interface* chapter for command options and usage notes.

Example 16-1 Example Command to View the Bill of Materials from the Command Line for Bare Metal Deployments

```
# odacli describe-system -b
ODA Components Information
-----
Component Name          Component
Details
```



```

-----
-----
-----
NODE                               Name : odal
                                   Domain Name : testdomain.com
                                   Time Stamp : April 21, 2020 6:21:15 AM
UTC

RPMS                               Installed RPMS :
abrt-2.1.11-55.0.1.el7.x86_64,
                                   abrt-addon-
ccpp-2.1.11-55.0.1.el7.x86_64,
                                   abrt-addon-
kerneloops-2.1.11-55.0.1.el7.x86_64,
                                   abrt-addon-
pstoreoops-2.1.11-55.0.1.el7.x86_64,
                                   abrt-addon-
python-2.1.11-55.0.1.el7.x86_64,
                                   abrt-addon-
vmcore-2.1.11-55.0.1.el7.x86_64,
                                   abrt-addon-
xorg-2.1.11-55.0.1.el7.x86_64,
                                   abrt-
cli-2.1.11-55.0.1.el7.x86_64,
                                   abrt-console-
notification-2.1.11-55.0.1.el7.x86_64,
                                   abrt-
dbus-2.1.11-55.0.1.el7.x86_64,
                                   abrt-
libs-2.1.11-55.0.1.el7.x86_64,
                                   abrt-
python-2.1.11-55.0.1.el7.x86_64,
                                   abrt-
tui-2.1.11-55.0.1.el7.x86_64,
                                   acl-2.2.51-14.el7.x86_64,
                                   adwaita-cursor-
theme-3.28.0-1.el7.noarch,
                                   adwaita-icon-
theme-3.28.0-1.el7.noarch,
                                   aic94xx-
firmware-30-6.el7.noarch,
                                   alsa-
aide-0.15.1-13.0.1.el7.x86_64,
                                   alsa-
firmware-1.0.28-2.el7.noarch,
                                   alsa-tools-
lib-1.1.8-1.el7.x86_64,
                                   at-3.1.13-24.el7.x86_64,
                                   at-spi2-
firmware-1.1.0-1.el7.x86_64,
                                   at-spi2-
atk-2.26.2-1.el7.x86_64,
                                   at-spi2-
core-2.28.0-1.el7.x86_64,

```

```

atk-2.28.1-1.el7.x86_64,
attr-2.4.46-13.el7.x86_64,
audit-2.8.5-4.el7.x86_64,
audit-
audit-libs-
augeas-
autogen-
avahi-
bash-
bc-1.06.95-13.el7.x86_64,
bind-export-
bind-
bind-libs-
bind-
bind-
binutils-2.27-41.base.0.7.el7_7.2.x86_64,
biosdevname-0.7.3-2.el7.x86_64,
blktrace-1.0.5-9.el7.x86_64,
bnxtnvm-1.40.10-1.x86_64,
boost-date-
boost-
boost-
filesystem-1.53.0-27.el7.x86_64,
iostreams-1.53.0-27.el7.x86_64,
....
....
....

```

Example 16-2 Example Command to View the Bill of Materials from the Command Line for Virtualized Platforms

```
# oakcli describe-system -b
```

Example 16-3 Example Command to View the Bill of Materials Report from the Stored Location

```
# ls -la /opt/oracle/dcs/Inventory/  
total 264  
-rw-r--r-- 1 root root 83550 Apr 26 05:41  
oda_bom_2018-04-26_05-41-36.json
```

Errors When Logging into the Browser User Interface

If you have problems logging into the Browser User Interface, then it may be due to your browser or credentials.

 **Note:**

Oracle Database Appliance uses self-signed certificates. Your browser determines how you log into the Browser User Interface. Depending on the browser and browser version, you may receive a warning or error that the certificate is invalid or not trusted because it is self-signed, or that the connection is not private. Ensure that you accept the self-signed certificate for the agent and Browser User Interface.

Follow these steps to log into the Browser User Interface:

1. Open a browser window.
2. Go to the following URL: `https://ODA-host-ip-address:7093/mgmt/index.html`
3. Get the security certificate (or certificate), confirm the security exception, and add an exception.
4. Log in with your Oracle Database Appliance credentials.

If you have not already set the `oda-admin` password, then a message is displayed, advising you to change the default password to comply with your system security requirements.

5. If you have not added an exception for the agent security certificate, then a message about accepting agent certificate is displayed.
6. Using a different tab in your browser, go to the following URL: `https://ODA-host-ip-address:7070/login`
7. Get the security certificate (or certificate), confirm the security exception, and add an exception.
8. Refresh the Browser User Interface URL : `https://ODA-host-ip-address:7093/mgmt/index.html`

 **Note:**

If you have any issues logging into the Oracle Database Appliance Browser User Interface on browsers such as macOS Catalina and Google Chrome, then you may need to use any workaround as described on the official site for the product.

Related Topics

- <http://www.oracle.com/technetwork/indexes/products/browser-policy-2859268.html>

Errors when re-imaging Oracle Database Appliance

Understand how to troubleshoot errors that occur when re-imaging Oracle Database Appliance.

If re-imaging Oracle Database Appliance fails, with old header issues such as errors in storage discovery, or in running GI root scripts, or disk group RECO creation, then use the force mode with `cleanup.pl`.

```
# cleanup.pl -f
```

To ensure that re-imaging is successful, remove the old headers from the storage disks by running the secure erase tool. Verify that the OAK/ASM headers are removed.

```
# cleanup.pl -erasedata  
# cleanup.pl -checkHeader
```

Retry the re-imaging operation.

Related Topics

- [Re-imaging Oracle Database Appliance](#)
Bare metal operating system re-imaging installs Oracle Database Appliance operating system software on the local (boot) drive.

Using Oracle Autonomous Health Framework for Running Diagnostics

Oracle Autonomous Health Framework collects and analyzes diagnostic data collected, and proactively identifies issues before they affect the health of your system.

- [About Installing Oracle Autonomous Health Framework](#)
Oracle Autonomous Health Framework is installed automatically when you provision or patch to Oracle Database Appliance release 19.10.
- [Using the Oracle ORAchK Health Check Tool](#)
Run Oracle ORAchK to audit configuration settings and check system health.

- [Generating and Viewing Oracle ORAchk Health Check Tool Reports in the Browser User Interface](#)
Generate Oracle ORAchk Health Check Tool reports using the Browser User Interface.
- [Generating and Viewing Database Security Assessment Reports in the Browser User Interface](#)
Generate and view Database Security Assessment Reports using the Browser User Interface.
- [Running Oracle Trace File Analyzer \(TFA\) Collector Commands](#)
Understand the installed location of `tfact1` and the options for the command.
- [Sanitizing Sensitive Information in Diagnostic Collections](#)
Oracle Autonomous Health Framework uses Adaptive Classification and Redaction (ACR) to sanitize sensitive data.
- [Sanitizing Sensitive Information in Oracle Trace File Analyzer Collections](#)
You can redact (sanitize or mask) Oracle Trace File Analyzer diagnostic collections.
- [Sanitizing Sensitive Information in Oracle ORAchk Output](#)
You can sanitize Oracle ORAchk output.

About Installing Oracle Autonomous Health Framework

Oracle Autonomous Health Framework is installed automatically when you provision or patch to Oracle Database Appliance release 19.10.

When you provision or patch your appliance to Oracle Database Appliance release 19.10, Oracle Autonomous Health Framework is installed in the path `/opt/oracle/dcs/oracle.ahf`.

You can verify that Oracle Autonomous Health Framework is installed by running the following command:

```
[root@oak ~]# rpm -q oracle-ahf
oracle-ahf-193000-#####.x86_64
```



Note:

When you provision or patch to Oracle Database Appliance release 19.10, Oracle Autonomous Health Framework automatically provides Oracle ORAchk Health Check Tool and Oracle Trace File Analyzer Collector.

Oracle ORAchk Health Check Tool performs proactive health checks for the Oracle software stack and scans for known problems. Oracle ORAchk Health Check Tool audits important configuration settings for Oracle RAC deployments in the following categories:

- Operating system kernel parameters and packages
- Oracle Database Database parameters, and other database configuration settings
- Oracle Grid Infrastructure, which includes Oracle Clusterware and Oracle Automatic Storage Management

Oracle ORAchk is aware of the entire system. It checks the configuration to indicate if best practices are being followed.

Oracle Trace File Collector provides the following key benefits and options:

- Encapsulation of diagnostic data collection for all Oracle Grid Infrastructure and Oracle RAC components on all cluster nodes into a single command, which you run from a single node
- Option to "trim" diagnostic files during data collection to reduce data upload size
- Options to isolate diagnostic data collection to a given time period, and to a particular product component, such as Oracle ASM, Oracle Database, or Oracle Clusterware
- Centralization of collected diagnostic output to a single node in Oracle Database Appliance, if desired
- On-Demand Scans of all log and trace files for conditions indicating a problem
- Real-Time Scan Alert Logs for conditions indicating a problem (for example, Database Alert Logs, Oracle ASM Alert Logs, and Oracle Clusterware Alert Logs)

Using the Oracle ORAchk Health Check Tool

Run Oracle ORAchk to audit configuration settings and check system health.

Note:

Before running ORAchk, check for the latest version of Oracle Autonomous Health Framework, and download and install it. See My Oracle Support Note 2550798.1 for more information about downloading and installing the latest version of Oracle Autonomous Health Framework.

Running ORAchk on Oracle Database Appliance 19.10 Baremetal Systems for New Installation

When you provision or upgrade to Oracle Database Appliance 19.10, ORAchk is installed using Oracle Autonomous Framework in the directory `/opt/oracle/dcs/oracle.ahf`.

To run `orachk`, use the following command:

```
[root@oak bin]# orachk
```

When all checks are finished, a detailed report is available. The output displays the location of the report in an HTML format and the location of a zip file if you want to upload the report. For example, you can choose the filter to show failed checks only, show checks with a Fail, Warning, Info, or Pass status, or any combination.

Review the Oracle Database Appliance Assessment Report and system health and troubleshoot any issues that are identified. The report includes a summary and filters that enable you to focus on specific areas.

Running ORAchk on Oracle Database Appliance 19.10 Virtualized Platform

When you provision or upgrade to Oracle Database Appliance 19.10, ORAchk is installed using Oracle Autonomous Framework in the directory `/opt/oracle.ahf`.

To run `orachk`, use the following command:

```
[root@oak bin]# oakcli orachk
```

Related Topics

- <https://support.oracle.com/rs?type=doc&id=2550798.1>

Generating and Viewing Oracle ORAchk Health Check Tool Reports in the Browser User Interface

Generate Oracle ORAchk Health Check Tool reports using the Browser User Interface.

1. Log into the Browser User Interface with the `oda-admin` username and password.

```
https://Node0-host-ip-address:7093/mgmt/index.html
```

2. Click the **Monitoring** tab.

3. In the Monitoring page, on the left navigation pane, click **ORAchk Report**.

On the ORAchk Reports page, a list of all the generated ORAchk reports is displayed.

4. In the Actions menu for the ORAchk report you want to view, click **View**.

The Oracle Database Appliance Assessment Report is displayed. It contains details of the health of your deployment, and lists current risks, recommendations for action, and links for additional information.

5. **To create an on-demand ORAchk report:** On the ORAchk Reports page, click **Create** and then click **Yes** in the confirmation box.

The job to create an ORAchk report is submitted.

6. Click the link to view the status of the job. Once the job completes successfully, you can view the Oracle Database Appliance Assessment Report on the ORAchk Reports page.

7. **To delete an ORAchk report:** In the Actions menu for the ORAchk report you want to delete, click **Delete**.

Generating and Viewing Database Security Assessment Reports in the Browser User Interface

Generate and view Database Security Assessment Reports using the Browser User Interface.

1. Log into the Browser User Interface with the `oda-admin` username and password.

```
https://Node0-host-ip-address:7093/mgmt/index.html
```

2. Click the **Security** tab.
3. In the Security page, on the left navigation pane, click **DBSAT Reports**.
On the Database Security Assessment Reports page, a list of all the generated DBSAT reports is displayed.
4. In the Actions menu for the ORAchk report you want to view, click **View**.
The Oracle Database Security Assessment Report is displayed. It contains details of the health of your deployment, and lists current risks, recommendations for action, and links for additional information.
5. **To create a DBSAT report:** On the DBSAT Reports page, click **Create** and then click **Yes** in the confirmation box.
The job to create a DBSAT report is submitted.
6. Click the link to view the status of the job. Once the job completes successfully, you can view the Oracle Database Appliance Assessment Report on the DBSAT Reports page.
7. **To delete a DBSAT report:** In the Actions menu for the DBSAT report you want to delete, click **Delete**.

Running Oracle Trace File Analyzer (TFA) Collector Commands

Understand the installed location of `tfactl` and the options for the command.

About Using `tfactl` to Collect Diagnostic Information

When you provision or upgrade to Oracle Database Appliance 19.10, Oracle Trace File Analyzer (TFA) Collector is installed in the directory `/opt/oracle.ahf/bin/tfactl`. You can invoke the command line utility for TFA, `tfactl` from the directory `/opt/oracle.ahf/bin/tfactl`, or simply type `tfactl`.

You can use the following command options to run `tfactl`:

```
/opt/oracle.ahf/bin/tfactl diagcollect -ips|-oda|-odalite|-dcs|-
odabackup|
-odapatching|-odadataguard|-odaprovisioning|-odaconfig|-odasystem|-
odastorage|-database|
-asm|-crsclient|-dbclient|-dbwlm|-tns|-rhp|-procinfo|-afd|-crs|-cha|-
wls|
-emagent|-oms|-ocm|-emplugins|-em|-acfs|-install|-cfgtools|-os|-
ashhtml|-ashtext|
-awrhtml|-awrtext -mask -sanitize
```

Table 16-1 Command Options for `tfactl` Tool

Option	Description
-h	(Optional) Describes all the options for this command.
-ips	(Optional) Use this option to view the diagnostic logs for the specified component.
-oda	(Optional) Use this option to view the logs for the entire Appliance.

Table 16-1 (Cont.) Command Options for tfactl Tool

Option	Description
-odalite	(Optional) Use this option to view the diagnostic logs for the odalite component.
-dcs	(Optional) Use this option to view the DCS log files.
-odabackup	(Optional) Use this option to view the diagnostic logs for the backup components for the Appliance.
-odapatching	(Optional) Use this option to view the diagnostic logs for patching components of the Appliance.
-odadataguard	(Optional) Use this option to view the diagnostic logs for Oracle Data Guard component of the Appliance.
-odaprovisioning	(Optional) Use this option to view provisioning logs for the Appliance.
-odaconfig	(Optional) Use this option to view configuration-related diagnostic logs.
-odasystem	(Optional) Use this option to view system information.
-odastorage	(Optional) Use this option to view the diagnostic logs for the Appliance storage.
-database	(Optional) Use this option to view database-related log files.
-asm	(Optional) Use this option to view the diagnostic logs for the Appliance.
-crsclient	(Optional) Use this option to view the diagnostic logs for the Appliance.
-dbclient	(Optional) Use this option to view the diagnostic logs for the Appliance.
-dbwlm	(Optional) Use this option to view the diagnostic logs for the specified component.
-tns	(Optional) Use this option to view the diagnostic logs for TNS.
-rhp	(Optional) Use this option to view the diagnostic logs for Rapid Home Provisioning.
-afd	(Optional) Use this option to view the diagnostic logs for Oracle ASM Filter Driver.
-crs	(Optional) Use this option to view the diagnostic logs for Oracle Clusterware.
-cha	(Optional) Use this option to view the diagnostic logs for the Cluster Health Monitor.
-wls	(Optional) Use this option to view the diagnostic logs for Oracle WebLogic Server.
-emagent	(Optional) Use this option to view the diagnostic logs for the Oracle Enterprise Manager agent.

Table 16-1 (Cont.) Command Options for tfactl Tool

Option	Description
-oms	(Optional) Use this option to view the diagnostic logs for the Oracle Enterprise Manager Management Service.
-ocm	(Optional) Use this option to view the diagnostic logs for the specified component.
-emplugins	(Optional) Use this option to view the diagnostic logs for Oracle Enterprise Manager plug-ins.
-em	(Optional) Use this option to view the diagnostic logs for Oracle Enterprise Manager deployment.
-acfs	(Optional) Use this option to view the diagnostic logs for Oracle ACFS storage.
-install	(Optional) Use this option to view the diagnostic logs for installation.
-cfgtools	(Optional) Use this option to view the diagnostic logs for the configuration tools.
-os	(Optional) Use this option to view the diagnostic logs for the operating system.
-ashhtml	(Optional) Use this option to view the diagnostic logs for the specified component.
-ashtext	(Optional) Use this option to view the diagnostic logs for the Appliance.
-awrhtml	(Optional) Use this option to view the diagnostic logs for the Appliance.
-awrtext	(Optional) Use this option to view the diagnostic logs for the specified component.
-mask	(Optional) Use this option to choose to mask sensitive data in the log collection.
-sanitize	(Optional) Use this option to choose to sanitize (redact) sensitive data in the log collection.

Usage Notes

You can use Trace File Collector (the `tfactl` command) to collect all log files for the Oracle Database Appliance components.

You can also use the command `odaadmcli manage diagcollect`, with similar command options, to collect the same diagnostic information.

For more information about using the `-mask` and `-sanitize` options, see the next topic.

Sanitizing Sensitive Information in Diagnostic Collections

Oracle Autonomous Health Framework uses Adaptive Classification and Redaction (ACR) to sanitize sensitive data.

After collecting copies of diagnostic data, Oracle Trace File Analyzer and Oracle ORAchk use Adaptive Classification and Redaction (ACR) to sanitize sensitive data in the collections. ACR uses a Machine Learning based engine to redact a pre-defined set of entity types in a given set of files. ACR also sanitizes or masks entities that occur in path names. Sanitization replaces a sensitive value with random characters. Masking replaces a sensitive value with a series of asterisks ("*").

ACR currently sanitizes the following entity types:

- Host names
- IP addresses
- MAC addresses
- Oracle Database names
- Tablespace names
- Service names
- Ports
- Operating system user names

ACR also masks user data from the database appearing in block and redo dumps.

Example 16-4 Block dumps before redaction

```
14A533F40 00000000 00000000 00000000 002C0000 [.....,]
14A533F50 35360C02 30352E30 31322E37 380C3938 [..650.507.2189.8]
14A533F60 31203433 37203332 2C303133 360C0200 [34 123 7310,..6]
```

Example 16-5 Block dumps after redaction

```
14A533F40 ***** ***** ***** ***** [*****]
14A533F50 ***** ***** ***** ***** [*****]
14A533F60 ***** ***** ***** ***** [*****]
```

Example 16-6 Redo dumps before redaction

```
col 74: [ 1] 80
col 75: [ 5] c4 0b 19 01 1f
col 76: [ 7] 78 77 06 16 0c 2f 26
```

Example 16-7 Redo dumps after redaction

```
col 74: [ 1] **
col 75: [ 5] ** ** ** ** **
col 76: [ 7] ** ** ** ** ** ** ** ** **
```

Redaction of Literal Values in SQL Statements in AWR, ASH and ADDM Reports

Automatic Workload Repository (AWR), Active Session History (ASH), and Automatic Database Diagnostic Monitor (ADDM) reports are HTML files, which contain sensitive entities such as hostnames, database names, and service names in the form of HTML tables. In addition to these sensitive entities, they also contain SQL statements, that can contain bind variables or literal values from tables. These literal values can be sensitive personal information (PI) stored in databases. ACR processes such reports to identify and redact both usual sensitive entities and literal values present in the SQL statements.

Sanitizing Sensitive Information Using odaadmcli Command

Use the `odaadmcli manage diagcollect` command to collect diagnostic logs for Oracle Database Appliance components. During collection, ACR can be used to redact (sanitize or mask) the diagnostic logs.

```
odaadmcli manage diagcollect [--dataMask|--dataSanitize]
```

In the command, the `--dataMask` option blocks out the sensitive data in all collections, for example, replaces `myhost1` with `*****`. The default is `None`. The `--dataSanitize` option replaces the sensitive data in all collections with random characters, for example, replaces `myhost1` with `orzhm1`. The default is `None`.

Sanitizing Sensitive Information in Oracle Trace File Analyzer Collections

You can redact (sanitize or mask) Oracle Trace File Analyzer diagnostic collections.

Enabling Automatic Redaction

To enable automatic redaction, use the command:

```
tfactl set redact=[mask|sanitize|none]
```

In the command, the `-mask` option blocks out the sensitive data in all collections, for example, replaces `myhost1` with `*****`. The `-sanitize` option replaces the sensitive data in all collections with random characters, for example, replaces `myhost1` with `orzhm1`. The `none` option does not mask or sanitize sensitive data in collections. The default is `none`.

Enabling On-Demand Redaction

You can redact collections on-demand, for example, `tfactl diagcollect -srdc ORA-00600 -mask` or `tfactl diagcollect -srdc ORA-00600 -sanitize`.

1. To mask sensitive data in all collections:

```
tfactl set redact=mask
```

- To sanitize sensitive data in all collections:

```
tfactl set redact=sanitize
```

Example 16-8 Masking or Sanitizing Sensitive Data in a Specific Collection

```
tfactl diagcollect -srdc ORA-00600 -mask  
tfactl diagcollect -srdc ORA-00600 -sanitize
```

Sanitizing Sensitive Information in Oracle ORAchK Output

You can sanitize Oracle ORAchK output.

To sanitize Oracle ORAchK output, include the `-sanitize` option, for example, `orachk -profile asm -sanitize`. You can also sanitize post process by passing in an existing log, HTML report, or a zip file, for example, `orachk -sanitize file_name`.

Example 16-9 Sanitizing Sensitive Information in Specific Collection IDs

```
orachk -sanitize comma_delimited_list_of_collection_IDS
```

Example 16-10 Sanitizing a File with Relative Path

```
orachk -sanitize new/orachk_node061919_053119_001343.zip  
orachk is sanitizing  
/scratch/testuser/may31/new/orachk_node061919_053119_001343.zip. Please  
wait...
```

```
Sanitized collection is:  
/scratch/testuser/may31/orachk_aydv061919_053119_001343.zip  
orachk -sanitize ../orachk_node061919_053119_001343.zip  
orachk is sanitizing  
/scratch/testuser/may31/../orachk_node061919_053119_001343.zip. Please  
wait...
```

```
Sanitized collection is:  
/scratch/testuser/may31/orachk_aydv061919_053119_001343.zip
```

Example 16-11 Sanitizing Oracle Autonomous Health Framework Debug Log

```
orachk -sanitize new/orachk_debug_053119_023653.log  
orachk is sanitizing /scratch/testuser/may31/new/  
orachk_debug_053119_023653.log.  
Please wait...
```

```
Sanitized collection is: /scratch/testuser/may31/  
orachk_debug_053119_023653.log
```

Example 16-12 Running Full Sanity Check

```
orachk -localonly -profile asm -sanitize -silentforce
```

```
Detailed report (html) -
/scratch/testuser/may31/orachk_node061919_053119_04448/
orachk_node061919_053119_04448.html
```

```
orachk is sanitizing /scratch/testuser/may31/
orachk_node061919_053119_04448.
Please wait...
```

```
Sanitized collection is: /scratch/testuser/may31/
orachk_aydv061919_053119_04448
```

```
UPLOAD [if required] - /scratch/testuser/may31/
orachk_node061919_053119_04448.zip
```

To reverse lookup a sanitized value, use the command:

```
orachk -rmap all|comma_delimited_list_of_element_IDs
```

You can also use `orachk -rmap` to lookup a value sanitized by Oracle Trace File Analyzer.

Example 16-13 Printing the Reverse Map of Sanitized Elements

```
orachk -rmap MF_NK1,fc63u2
```

Entity Type	Substituted Entity Name	Original Entity Name
dbname	MF_NK1	HR_DB1
dbname	fc63u2	rac12c2

```
orachk -rmap all
```

Running the Disk Diagnostic Tool

Use the Disk Diagnostic Tool to help identify the cause of disk problems.

The tool produces a list of 14 disk checks for each node. To display details, where `n` represents the disk resource name, enter the following command:

```
# odaadmcli stordiag n
```

For example, to display detailed information for NVMe `pd_00`:

```
# odaadmcli stordiag pd_00
```

Running the Oracle Database Appliance Hardware Monitoring Tool

The Oracle Database Appliance Hardware Monitoring Tool displays the status of different hardware components in Oracle Database Appliance server.

The tool is implemented with the Trace File Analyzer collector. Use the tool both on bare-metal and on virtualized systems. The Oracle Database Appliance Hardware Monitoring Tool reports information only for the node on which you run the command. The information it displays in the output depend on the component that you select to review.

Bare Metal Platform

You can see the list of monitored components by running the command `odaadmcli show -h`

To see information about specific components, use the command syntax `odaadmcli show component`, where *component* is the hardware component that you want to query. For example, the command `odaadmcli show power` shows information specifically about the Oracle Database Appliance power supply:

```
# odaadmcli show power
```

NAME	HEALTH	HEALTH_DETAILS	PART_NO.	SERIAL_NO.
Power_Supply_0	OK	-	7079395	476856Z+1514CE056G

(Continued)

LOCATION	INPUT_POWER	OUTPUT_POWER	INLET_TEMP	EXHAUST_TEMP
PS0	Present	112 watts	28.000 degree C	34.938 degree C

Virtualized Platform

You can see the list of monitored components by running the command `oakcli show -h`

To see information about specific components, use the command syntax `oakcli show component`, where *component* is the hardware component that you want to query. For example, the command `oakcli show power` shows information specifically about the Oracle Database Appliance power supply:

```
# oakcli show power
```

NAME	HEALTH	HEALTH_DETAILS	PART_NO.	SERIAL_NO.
Power Supply_0	OK	-	7047410	476856F+1242CE0020
Power Supply_1	OK	-	7047410	476856F+1242CE004J

(Continued)

LOCATION	INPUT_POWER	OUTPUT_POWER	INLET_TEMP	EXHAUST_TEMP
----------	-------------	--------------	------------	--------------

PS0	Present	88 watts	31.250 degree C	34.188 degree C
PS1	Present	66 watts	31.250 degree C	34.188 degree C

 **Note:**

Oracle Database Appliance Server Hardware Monitoring Tool is enabled during initial startup of ODA_BASE on Oracle Database Appliance Virtualized Platform. When it starts, the tool collects base statistics for about 5 minutes. During this time, the tool displays the message "Gathering Statistics..." message.

Configuring a Trusted SSL Certificate for Oracle Database Appliance

The Browser User Interface and DCS Controller use SSL-based HTTPS protocol for secure communication. Understand the implications of this added security and the options to configure SSL certificates.

The Browser User Interface provides an added layer of security using certificates and encryption, when an administrator interacts with the appliance. Encryption of data ensures that:

- Data is sent to the intended recipient, and not to any malicious third-party.
- When data is exchanged between the server and the browser, data interception cannot occur nor can the data be edited.

When you connect to the Browser User Interface through HTTPS, the DCS Controller presents your browser with a certificate to verify the identity of appliance. If the web browser finds that the certificate is not from a trusted Certificate Authority (CA), then the browser assumes it has encountered an untrusted source, and generates a security alert message. The security alert dialog boxes display because Browser User Interface security is enabled through HTTPS and SSL, but you have not secured your Web tier properly with a trusted matching certificate from a Certificate Authority. It is possible to purchase commercial certificates from a Certificate Authority or create your own and register them with a Certificate Authority. However, the server and browser certificates must use the same public certificate key and trusted certificate to avoid the error message produced by the browser.

There are three options to configure your certificates:

- Create your own key and Java keystore, ensure it is signed by a Certificate Authority (CA) and then import it for use.
- Package an existing Privacy Enhanced Mail (PEM) format key and certificates in a new Java keystore.
- Convert an existing PKCS or PFX keystore to a Java keystore and configure it for the Browser User Interface.

 **Note:**

For Oracle Database Appliance High-Availability hardware models, run the configuration steps on **both** nodes.

The following topics explain how to configure these options:

- [Option 1: Creating a Key and Java Keystore and Importing a Trusted Certificate](#)
Use `keytool`, a key and certificate management utility, to create a keystore and a signing request.
- [Option 2: Packaging an Existing PEM-format Key and Certificates in a New Java Keystore](#)
Use the OpenSSL tool to package Privacy Enhanced Mail (PEM) files in a PKCS keystore.
- [Option 3: Converting an Existing PKCS or PFX Keystore to a Java Keystore](#)
If you have an existing PKCS or PFX keystore for your server's domain, convert it to a Java keystore.
- [Configuring the DCS Server to Use Custom Keystore](#)
After packaging or converting your keystore into Java keystore, configure the DCS server to use your keystore.
- [Configuring the DCS Agent for Custom Certificate](#)
After you import the certificate into the keystore, configure the DCS agent to use the same certificate.

Option 1: Creating a Key and Java Keystore and Importing a Trusted Certificate

Use `keytool`, a key and certificate management utility, to create a keystore and a signing request.

1. Create the keystore:

```
keytool -genkeypair -alias your.domain.com -storetype jks -keystore
your.domain.com.jks -validity 366 -keyalg RSA -keysize 4096
```

2. The command prompts you for identifying data:

```
1. What is your first and last name? your.domain.com
2. What is the name of your organizational unit? yourunit
3. What is the name of your organization? yourorg
4. What is the name of your City or Locality? yourcity
5. What is the name of your State or Province? yourstate
6. What is the two-letter country code for this unit? US
```

3. Create the certificate signing request (CSR):

```
keytool -certreq -alias your.domain.com -file your.domain.com.csr
-keystore your.domain.com.jks -ext san=dns:your.domain.com
```

4. Request a Certificate Authority (CA) signed certificate:

- a. In the directory where you ran Step 1 above, locate the file `your.domain.com.csr`.
 - b. Submit the file to your Certificate Authority (CA).
Details vary from one CA to another. Typically, you submit your request through a website; then the CA contacts you to verify your identity. CAs can send signed reply files in a variety of formats, and CAs use a variety of names for those formats. The CA's reply must be in PEM or PKCS#7 format.
 - c. There may be a waiting period for the CA's reply.
5. Import the CA's reply. The CA's reply will provide one PKCS file or multiple PEM files.
 - a. Copy the CA's files into the directory where you created the keystore in Step 1 above.
 - b. Use `keytool` to export the certificate from the keystore:

```
keytool -exportcert -alias your.domain.com -file /opt/oracle/dcs/
conf/keystore-cert.crt
-keystore your.domain.name.jks
```

6. Use `keytool` to import the keystore certificate and the CA reply files:

```
keytool -importcert -trustcacerts -alias your.domain.com
-file /opt/oracle/dcs/conf/keystore-cert.crt -keystore /opt/
oracle/dcs/conf/dcs-ca-certs
```

To import PKCS file, run the command:

```
keytool -importcert -trustcacerts -alias your.domain.com -file
CAreply.pkcs -keystore /opt/oracle/dcs/conf/dcs-ca-certs
```

`CAreply.pkcs` is the name of the PKCS file provided by the CA and `your.domain.com` is the complete domain name of your server.

If the CA sent PEM files, then there may be one file, but most often there are two or three. Import the files to your keystore with commands in the order shown below, after substituting your values:

```
keytool -importcert -alias root -file root.cert.pem -keystore /opt/
oracle/dcs/conf/dcs-ca-certs -trustcacerts
keytool -importcert -alias intermediate -file intermediate.cert.pem
/opt/oracle/dcs/conf/dcs-ca-certs -trustcacerts
keytool -importcert -alias intermediat2 -file intermediat2.cert.pem
/opt/oracle/dcs/conf/dcs-ca-certs -trustcacerts
keytool -importcert -alias your.domain.com -file server.cert.pem
/opt/oracle/dcs/conf/dcs-ca-certs -trustcacerts
```

`root.cert.pem` is the name of the root certificate file and `intermediate.cert.pem` is the name of the intermediate certificate file. The root and intermediate files link the CA's signature to a widely trusted root certificate that is known to web browsers. Most, but not all, CA replies include roots and intermediates.

server.cert.pem is the name of the server certificate file. The file links your domain name with your public key and the CA's signature.

Option 2: Packaging an Existing PEM-format Key and Certificates in a New Java Keystore

Use the OpenSSL tool to package Privacy Enhanced Mail (PEM) files in a PKCS keystore.

If you have an existing private key and certificates for your server's domain in PEM format, importing them into a Java keystore requires the OpenSSL tool. OpenSSL can package the PEM files in a PKCS keystore. Java keytool can then convert the PKCS keystore to a Java keystore.

1. Install OpenSSL.
2. Copy your private key, server certificate, and intermediate certificate into one directory.
3. Package the key and certificates into a PKCS keystore as follows:

```
openssl pkcs12 -export -in server.cert.pem -inkey private.key.pem
-certfile
intermediate.cert.pem -name "your.domain.com" -out
your.domain.com.p12
```

server.cert.pem is the name of the server certificate file, *your.domain.com* is the complete domain name of your server, *private.key.pem* is the private counterpart to the public key in *server.cert.pem*, and *intermediate.cert.pem* is the name of the intermediate certificate file.

Convert the resulting PKCS keystore file, *your.domain.com.p12* into a Java keystore.

Option 3: Converting an Existing PKCS or PFX Keystore to a Java Keystore

If you have an existing PKCS or PFX keystore for your server's domain, convert it to a Java keystore.

1. Run the command:

```
keytool -importkeystore -srckeystore your.domain.com.p12 -
srcstoretype PKCS12
-destkeystore /opt/oracle/dcs/conf/dcs-ca-certs -deststoretype jks
```

your.domain.com.p12 is the existing keystore file and *your.domain.com* is the complete domain name of your server.

2. Configure the DCS server as explained in the topic *Configuring the DCS Server to Use Custom Keystore*.

Configuring the DCS Server to Use Custom Keystore

After packaging or converting your keystore into Java keystore, configure the DCS server to use your keystore.

1. Login to the appliance.

```
ssh -l root oda-host-name
```

2. Generate the obfuscated keystore password:

```
java -cp /opt/oracle/dcs/bin/dcs-controller-n.n.n.-SNAPSHOT.jar  
org.eclipse.jetty.util.security.Password keystore-password
```

For example:

```
[root@oda]# java -cp /opt/oracle/dcs/bin/dcs-controller-2.4.18-  
SNAPSHOT.jar  
org.eclipse.jetty.util.security.Password test  
12:46:33.858 [main] DEBUG org.eclipse.jetty.util.log  
- Logging to Logger[org.eclipse.jetty.util.log] via  
org.eclipse.jetty.util.log.Slf4jLog  
12:46:33.867 [main] INFO org.eclipse.jetty.util.log  
- Logging initialized @239ms to org.eclipse.jetty.util.log.Slf4jLog  
test  
OBF:1z0f1vu91vv11z0f  
MD5:098f6bcd4621d373cade4e832627b4f6  
[root@scaoda7s001 conf]#
```

Copy the password that starts with OBF:.

3. Update the DCS controller configuration file.

```
cd /opt/oracle/dcs/conf
```

Update the following parameters in `dcs-controller.json`:

```
"keyStorePath": "keystore-directory-path/your.domain.com.jks"  
"trustStorePath": /opt/oracle/dcs/conf/dcs-ca-certs  
"keyStorePassword": "obfuscated keystorepassword"  
"certAlias": "your.domain.com"
```

4. Restart the DCS Controller.

```
systemctl stop initdcscontroller  
systemctl start initdcscontroller
```

5. Access the Browser User Interface at `https://oda-host-name:7093/mgmt/index.html`.

Configuring the DCS Agent for Custom Certificate

After you import the certificate into the keystore, configure the DCS agent to use the same certificate.

1. Update the DCS agent configuration file:

```
cd /opt/oracle/dcs/conf
```

Update the following parameters in the `dcs-agent.json` file:

```
"keyStorePath": "keystore-directory-path/your.domain.com.jks"  
"trustStorePath": /opt/oracle/dcs/conf/dcs-ca-certs  
"keyStorePassword": "obfuscated keystorepassword"  
"certAlias": "your.domain.com"
```

2. Restart the DCS agent:

```
systemctl stop initdcsagent  
systemctl start initdcsagent
```

3. Access the agent at `https://oda-host-name:7070`.
4. Update the CLI certificates.

```
cp -f /opt/oracle/dcs/conf/dcs-ca-certs  
/opt/oracle/dcs/dcscli/dcs-ca-certs
```

5. Update the DCS command-line configuration files:

```
[root@]# cd /opt/oracle/dcs/dcscli
```

Update the following parameters in `dcscli-adm.conf` and `dcscli.conf`:

```
TrustStorePath=/opt/oracle/dcs/conf/dcs-ca-certs  
TrustStorePassword=keystore_password
```

Disabling the Browser User Interface

You can also disable the Browser User Interface. Disabling the Browser User Interface means you can only manage your appliance through the command-line interface.

1. Log in to the appliance:

```
ssh -l root oda-host-name
```

2. Stop the DCS controller. For High-Availability systems, run the command on both nodes.

```
systemctl stop initdcscontroller
```

Preparing Log Files for Oracle Support Services

If you have a system fault that requires help from Oracle Support Services, then you may need to provide log records to help Oracle support diagnose your issue.

You can collect diagnostic information for your appliance in the following ways:

- Use the Bill Of Materials report saved in the `/opt/oracle/dcs/Inventory/` directory, to enable Oracle Support to help troubleshoot errors, if necessary.
- You can use Trace File Collector (the `tfactl` command) to collect all log files for the Oracle Database Appliance components.
- Use the command `odaadmcli manage diagcollect` to collect diagnostic files to send to Oracle Support Services.

The `odaadmcli manage diagcollect` command consolidates information from log files stored on Oracle Database Appliance into a single log file for use by Oracle Support Services. The location of the file is specified in the command output.

Example 16-14 Collecting log file information for a time period, masking sensitive data

```
# odaadmcli manage diagcollect --dataMask --fromTime 2019-08-12 --
toTime 2019-08-25
DataMask is set as true
FromTime is set as: 2019-08-12
ToTime is set as: 2019-08-25
TFACTL command is: /opt/oracle/tfa/tfa_home/bin/tfactl
Data mask is set.
Collect data from 2019-08-12
Collect data to 2019-08-25
```

A

Oracle Database Appliance Software Configuration Defaults

Oracle Database Appliance software configuration defaults.

- [Directory Paths for Oracle Database Appliance](#)
Locate the storage and mount configuration file paths for Oracle Database Appliance.
- [Location of Log Files](#)
Log files are available for actions performed in the command-line interface and Browser User Interface and are useful when you need to track and debug jobs.
- [Oracle Groups and User Configurations for Oracle Database Appliance](#)
Review the groups and default users when you use the Browser User Interface to deploy the appliance. All passwords are set to the password that you define during deployment.

Directory Paths for Oracle Database Appliance

Locate the storage and mount configuration file paths for Oracle Database Appliance.

Oracle homes on Oracle Database Appliance follow Optimal Flexible Architecture guidelines.

Directory Paths for Oracle Database Appliance

Item	Directory Path
Grid home	<i>/u01/app/release-specific_name/gi owner</i>
Grid base	<i>/u01/app/gi owner</i>
Oracle home	<i>/u01/app/rdbms owner/product/rdbms_version/dbhome_home_sequence_number</i>
Oracle base	<i>/u01/app/rdbms owner</i>
Oracle Inventory	<i>/u01/app/oraInventory</i>
Java Runtime Environment (JRE)	<i>/opt/oracle/dcs/java/release_specific_JRE_version/</i>
Java SDK	<i>/opt/oracle/dcs/odajavask/</i>

Location of Log Files

Log files are available for actions performed in the command-line interface and Browser User Interface and are useful when you need to track and debug jobs.

You can also use the Oracle Appliance Manager Browser User Interface to view job activity, including the tasks that make up the job. The status of each task appears in the Browser User Interface and you can drill down to get greater details.

If you log a Service Request, upload all of the logs in the `/opt/oracle/dcs/log` and `/opt/oracle/dcs/dcscli/log` directories.

Patching Log Files

All patching-related information is logged in the `dcs-agent` log in the directory `/opt/oracle/dcs/log/`.

DCS Agent Log Directories

Agent-specific activities are logged in the `dcs-agent` log.

The DCS Agent, controller, and command-line interface output are stored in the directory `/opt/oracle/dcs/log/`.

If an error occurs in the command-line interface layer, then the output will show in the `/opt/oracle/dcs/dcscli/log/dcscli.log` file first.

DCS Components Log Directories

The Zookeeper logs are stored in the directory `/opt/zookeeper/log/`. The Zookeeper logs are `zkMonitor.log`, `zookeeper.log`, and `zookeeper.out`.

The MySQL logs are stored in the log `/opt/oracle/dcs/mysql/log/mysqlldb.log`. The log contains information about MySQL such as startup, shutdown, connection transaction details, and errors encountered when running MySQL.

Storage Logs

Storage-related activity is logged in the `oakd` log file.

```
/opt/oracle/oak/log/hostname/oak/oakd.log
```

For example, `/opt/oracle/oak/log/myhost/oak/oakd.log`

Use the `odaadmcli manage diagcollect` command to collect diagnostic logs for storage components. The files are saved in the `oakdiag` log file.

```
/opt/oracle/oak/log/hostname/oakdiag/file_name.tar.gz
```

For example, `/opt/oracle/oak/log/myhost/oakdiag/oakStorage-myhost-20161120_2217.tar.gz`

Database Logs

Online logs are stored in the `/u03/app/db user/redo/` directory.

Oracle Fast Recovery Area (FRA) is located in the `/u03/app/db user/fast_recovery_area` directory.

Database alert logs are stored in the location `$ORACLE_BASE/diag/rdbms/database_unique_name`.

Oracle Auto Service Request (Oracle ASR) Log Files

All log files for Oracle ASR are located in the `/var/opt/asrmanager/log/` directory.

Oracle Groups and User Configurations for Oracle Database Appliance

Review the groups and default users when you use the Browser User Interface to deploy the appliance. All passwords are set to the password that you define during deployment.

Default Operating System Groups and User Configurations

Table A-1 Default Operating System Groups and Users Configuration for Oracle Database Appliance

Groups and Users	Default Value
Oracle Grid Infrastructure installation owner	grid, UID 1001
Oracle Database installation owner	oracle, UID 1000
Oracle Database system administrator	sys
Oracle Database generic administrator	system
Oracle Inventory system privileges group	oinstall, GID 1001
Oracle ASM Administrators system privileges	asmadmin, GID 1004
Oracle ASM Users system privileges	asmdba, GID 1006
Oracle ASM Operator system privileges	asmoper, GID 1005
Oracle Database Administrators system privileges	dba, GID 1003
Oracle Database Operator system privileges	dbaoper, GID 1002

Oracle Groups and User Configurations

You can use the Browser User Interface or the `odacli create-appliance` command and a JSON file to deploy the appliance. The following configurations are supported:

- 2 Users with 6 groups (operating system role separation)
- Single User with 6 groups (no operating system role separation)
- Single user with 2 groups (no operating system role separation)

You can customize `groupname`, `username`, and `UID`.

B

Oracle Database Appliance Storage Defaults

Review this section to understand Oracle Database Appliance storage architecture and options and how to determine usable storage.

- [Database Disk Group Sizes for Oracle Database Appliance](#)
The table in this section shows the sizes for DATA, RECO, REDO, and FLASH disk groups on various configurations of Oracle Database Appliance.
- [Usable Storage on Oracle Database Appliance X5-2](#)
The table shows the usage storage available for various configurations of Oracle Database Appliance X5-2.
- [About Oracle Database Appliance Storage](#)
Use Oracle Automatic Storage Management (Oracle ASM) or Oracle Automatic Storage Management Cluster File System (Oracle ACFS) for database files storage.
- [Oracle ACFS Mount Points and Storage Space](#)
Review Oracle ASM Cluster file system (ACFS) mount points for Oracle Database Appliance.
- [Oracle ACFS Space Management](#)
The Oracle ACFS file systems are automatically created when you create a database on Oracle Database Appliance.

Database Disk Group Sizes for Oracle Database Appliance

The table in this section shows the sizes for DATA, RECO, REDO, and FLASH disk groups on various configurations of Oracle Database Appliance.

Each table row has values for either normal or for high redundancy levels. The disk capacities shown in the tables vary, because they are derived by converting disk hardware terabytes (based on 1 kilobyte equals 1,000 bytes) into data storage terabytes (based on 1 kilobyte equals 1,024 bytes).

The space calculated with a storage expansion shelf approximately doubles the space mentioned in these tables.

Table B-1 Approximate Database Disk Group Sizes for Oracle Database Appliance X5-2 and X6-2-HA

Sizing	X5-2 (GB), 4 TB	X5-2 (GB), 8 TB	X6-2-HA (GB), 8 TB
HDD Size	3,816	7,631	7,631
Total HDD	61,056	122,096	122,096
Total SSD (REDO Disk Group)	744	744	744

Table B-1 (Cont.) Approximate Database Disk Group Sizes for Oracle Database Appliance X5-2 and X6-2-HA

Sizing	X5-2 (GB), 4 TB	X5-2 (GB), 8 TB	X6-2-HA (GB), 8 TB
Total SSD (FLASH Disk Group)	1,492	1,492	1,492
Total HDD with High Redundancy	20,352	40,699	40,699
Total HDD with Normal Redundancy	30,528	61,048	61,048
DATA Disk Group with High Redundancy - External Backup	15,315	30,626	30,626
RECO Disk Group with High Redundancy - External Backup	2,493	4,986	4,986
DATA Disk Group with High Redundancy - Local Backup	7,473	16,407	16,407
RECO Disk Group with High Redundancy - Local Backup	9,906	21,748	21,748
DATA Disk Group with Normal Redundancy - External Backup	24,513	49,220	49,220
RECO Disk Group with Normal Redundancy - External Backup	4,007	8,013	8,013
DATA Disk Group with Normal Redundancy - Local Backup	12,307	24,610	24,610
RECO Disk Group with Normal Redundancy - Local Backup	15,920	32,623	32,623
REDO Disk Group	248	248	248
FLASH Disk Group	746	746	746

 **Note:**

1. For non-CDB databases, the REDO disk group has 50% free disk space.
2. For CDB databases, an Oracle ACFS mount point is created per CDB database, based on the template log file size. If this is a Single Instance (SI) database, then multiply by 3. If the is an Oracle RAC database, then multiply by 4.
3. Accelerator volume size is 0.4% of the database DATA Oracle ACFS file system size and shared REPO Oracle ACFS file system size.

 **Note:**

High Redundancy is triple-mirroring and Normal Redundancy is double-mirroring. The REDO Disk Group is always High Redundancy. The FLASH Disk Group is always Normal Redundancy.

 **See Also:**

[Oracle Automatic Storage Management Administrator's Guide](#), "Managing Capacity in Disk Groups" for more information about determining the amount of free space in your Oracle Database Appliance disk groups for Oracle ASM. The tables in this topic only provide the raw disk information.

Usable Storage on Oracle Database Appliance X5-2

The table shows the usage storage available for various configurations of Oracle Database Appliance X5-2.

The reserved storage is the amount of ASM storage required to maintain redundancy in the event of a disk failure. If you use the reserve storage capacity, then the system continues to run, and it is protected through ASM mirroring. However, in the event of a second disk failure, the system is then running in a non-protected and degraded mode. In this event, you must replace disks immediately. Refer to *Oracle Automatic Storage Management Administrator's Guide* for more information about ASM disk group capacity.

Table B-2 Usable Storage on Oracle Database Appliance X5-2

Sizing	Raw Value (GB)	Reserve (GB)	Usable (GB)
Total SSD (REDO Disk Group) (based on an estimated 190,780 GB) See the Note.	764	191	191
Total SSD (FLASH Disk Group) (based on an estimated 3,816 GB)	1,528	382	573
HDD Size: 8 TB	7,631		
External Backup/ Normal Redundancy (86%/14% split)			
DATA Disk Group with Normal Redundancy - External Backup	105,003	6,563	49,220
RECO Disk Group with Normal Redundancy - External Backup	17,093	1,068	8,013
External Backup/ High Redundancy			
DATA Disk Group with High Redundancy - External Backup	105,003	13,125	30,626
RECO Disk Group with High Redundancy - External Backup	17,093	2,137	4,986
Internal Backup/ Normal Redundancy (43%/57% split)			
DATA Disk Group with Normal Redundancy - Internal Backup	52,501	3,281	24,610
RECO Disk Group with Normal Redundancy - Internal Backup	69,595	4,350	32,623
Internal Backup/ High Redundancy			
DATA Disk Group with High Redundancy - Internal Backup	52,501	3,281	16,407
RECO Disk Group with High Redundancy - Internal Backup	69,595	4,350	21,748

Table B-2 (Cont.) Usable Storage on Oracle Database Appliance X5-2

Sizing	Raw Value (GB)	Reserve (GB)	Usable (GB)
HDD Size: 4 TB (Total: HDD Raw: 59,584 GB)	3,816		
External Backup/ Normal Redundancy (86%/14% split)			
DATA Disk Group with Normal Redundancy - External Backup	52,508	3,282	24,613
RECO Disk Group with Normal Redundancy - External Backup	8,548	534	4,007
External Backup/ High Redundancy			
DATA Disk Group with High Redundancy - External Backup	52,508	6564	15,315
RECO Disk Group with High Redundancy - External Backup	8,548	1,068	2,493
Internal Backup/ Normal Redundancy (43%/57% split)			
DATA Disk Group with Normal Redundancy - Internal Backup	26,254	1,641	12,307
RECO Disk Group with Normal Redundancy - Internal Backup	33,963	2,123	15,920
Internal Backup/ High Redundancy			
DATA Disk Group with High Redundancy - Internal Backup	25,621	3,203	7,473
RECO Disk Group with High Redundancy - Internal Backup	33,963	4,245	9,906

Related Topics

- [Administering Oracle ASM Disk Groups](#)

About Oracle Database Appliance Storage

Use Oracle Automatic Storage Management (Oracle ASM) or Oracle Automatic Storage Management Cluster File System (Oracle ACFS) for database files storage.

Database file systems are used exclusively for storing database files, and they include a DATA file system for database data files and a RECO file system for storing archive files and backups. Oracle Database Appliance supports Oracle ACFS and Oracle ASM database file storage. You determine the type of database storage when you create the database.

About Oracle ASM Database Storage

With Oracle ASM, database data files are stored in DATA diskgroup. Redo and archive files are in RECO diskgroup.

About Oracle ACFS Database Storage

With Oracle ACFS, an Oracle ACFS file system is created from DATA diskgroup for each database to store data files, and an Oracle ACFS file system is created from RECO diskgroup for redo and fast recovery area for all databases.

Oracle ACFS Mount Points and Storage Space

Review Oracle ASM Cluster file system (ACFS) mount points for Oracle Database Appliance.

If you select Oracle Automatic Storage Management (Oracle ASM) for database storage when you create a database, then an Oracle ASM Cluster file system (ACFS) is not created. All files are in an Oracle ASM diskgroup.

If you select Oracle ACFS for database storage, then each database has its own Oracle ACFS mount point:

- DATA diskgroup: `/u02/app/oracleuser/oradata/db_name`
- RECO diskgroup: `/u03/app/oracleuser`.

With Oracle ACFS, the following are created:

- A 100G ACFS is created from +DATA diskgroup for each database. This Oracle ACFS automatically extends the space on demand.
- A common Oracle ACFS with 25% of +RECO diskgroup is created with auto extension on. This file system is used for fast recovery area and redo logs for all databases.

Table B-3 Oracle ACFS Mount Points and Related Oracle ASM Disk Groups and Volume Information

File System	Oracle ASM Disk Group	Oracle ASM Dynamic Volume	Mount Point
DATA	+DATA	<code>/dev/asm/datadbname-<i>nnn</i></code> For example: <code>/dev/asm/datodacn-123</code>	<code>/u02/app/oracleuser/oradata/<i>dbname</i></code> For example: <code>/u02/app/example/oradata/odacn</code>
RECO	+RECO	<code>/dev/asm/reco-<i>nn</i></code>	<code>/u03/app/oracleuser</code> This mount point is shared by all databases for <code>fast_recovery_area</code> and redo logs. For <code>fast_recovery_area</code> , the path is: <code>/u03/app/oracleuser/fast_recovery_area/<i>db_name</i></code> For redo logs, the path is: <code>/u03/app/oracleuser/redo/<i>db_name</i></code>

Example B-1 Oracle ACFS Storage Space

When the Oracle ACFS file systems are created, they do not initially consume all of the storage in the appliance. Space is preserved for additional repositories, or in some cases, database files stored directly in Oracle ASM. You can check for available storage space in your file systems by running the operating system command `df -k` as shown in the following example.

```
# df -k
Filesystem                                1K-blocks  Used    Available Use%
```

Mounted on			
/dev/mapper/VolGroupSys-LogVolRoot	30963708	14203568	15187276
49% /			
tmpfs	65952292	647800	65304492
1% /dev/shm			
/dev/sda1	495844	43872	426372
10% /boot			
/dev/mapper/VolGroupSys-LogVolOpt	61927420	18594420	40187272
32% /opt			
/dev/mapper/VolGroupSys-LogVolU01	103212320	49621560	48347880
51% /u01			
/dev/asm/reco-62	76546048	1469676	75076372
2% /u03/app/oracle			
/dev/asm/datrd2-268	104857600	3872368	100985232
4% /u02/app/oracle/oradata/rdb2			
/dev/asm/datndb11-268	104857600	247160	104610440
1% /u02/app/oracle/oradata/ndb11			
/dev/asm/datndb12-268	104857600	247160	104610440
1% /u02/app/oracle/oradata/ndb12			

Oracle ACFS Space Management

The Oracle ACFS file systems are automatically created when you create a database on Oracle Database Appliance.

When you use Oracle ACFS for database storage, the following is created:

- A 100G ACFS is created from +DATA diskgroup for each database. This Oracle ACFS automatically extends the space on demand.
- A common Oracle ACFS with 25% of +RECO diskgroup is created with auto extension on. This file system is used for fast recovery area and redo logs for all databases.

When the Oracle ACFS file systems are created, they do not initially consume all of the storage in the appliance. Space is preserved for additional repositories, or in some cases, database files stored directly in Oracle ASM. You can check for available storage space in your file systems by running the operating system command `df -k` as shown in the following example.

```
# df -k
Filesystem                1K-blocks    Used    Available  Use%
Mounted on
/dev/mapper/VolGroupSys-LogVolRoot 30963708 14203568 15187276
49% /
tmpfs                       65952292    647800  65304492
1% /dev/shm
/dev/sda1                   495844      43872   426372
10% /boot
/dev/mapper/VolGroupSys-LogVolOpt 61927420 18594420 40187272
32% /opt
/dev/mapper/VolGroupSys-LogVolU01 103212320 49621560 48347880
51% /u01
/dev/asm/reco-62           76546048   1469676 75076372
2% /u03/app/oracle
/dev/asm/datrd2-268       104857600  3872368 100985232
4% /u02/app/oracle/oradata/rdb2
/dev/asm/datndb11-268    104857600  247160  104610440
1% /u02/app/oracle/oradata/ndb11
```

```
/dev/asm/datndb12-268          104857600    247160    104610440  
1%      /u02/app/oracle/oradata/ndb12
```

C

Creating an Appliance Using JSON File

Understand the process to create an appliance using the command `odacli create-appliance` and view an example JSON file.

- [Loading and Saving Appliance Configurations](#)
You can load a saved JSON file and use it to configure your appliance, and save an existing configuration as a JSON file from the Browser User Interface.
- [Readme for the Command `odacli create-appliance`](#)
If you want to create the appliance outside of the Browser User Interface, then review the readme file for details on how to create a JSON file to use with the command-line interface.
- [Example JSON Files to Create a Single Node Appliance with the CLI](#)
Follow these JSON file examples to create a JSON file to deploy a single node appliance with the command `odacli create-appliance`.
- [Example JSON File to Create a Multi-Node Appliance with the CLI](#)
Follow the JSON file example to create a JSON file to deploy a multi-node appliance with the command `odacli create-appliance`.

Loading and Saving Appliance Configurations

You can load a saved JSON file and use it to configure your appliance, and save an existing configuration as a JSON file from the Browser User Interface.

Using a Saved Configuration to Create a New Appliance in the Browser User Interface

You can load a saved configuration from your client machine, and create a new appliance.

1. Log into the Browser User Interface.
2. In the Create Appliance page, click **Browse** next to Load Configuration.
3. Select the JSON file from the local machine, being used to access the Browser User Interface.
4. The appliance configuration values from the JSON file are populated in the fields on the Create Appliance page.
5. Make any changes required, and submit the request to create the appliance
Note that for security requirements, you must enter passwords manually.

Saving an Appliance Configuration from the Browser User Interface

You can save an appliance configuration and use it to create another appliance.

1. Log into the Browser User Interface.
2. If you have already configured your appliance, then in the Create Appliance page, click **Save Configuration**.

3. The configuration is saved as a JSON file on the local machine, being used to access the Browser User Interface.

Readme for the Command `odacli create-appliance`

If you want to create the appliance outside of the Browser User Interface, then review the readme file for details on how to create a JSON file to use with the command-line interface.

You can use the command `odacli create-appliance` and a JSON file that includes your appliance configuration settings to deploy the appliance instead of using the Browser User Interface.

Note:

It is important to review the readme and the examples carefully before creating your JSON file. If you do not enter your network and Oracle ILOM information correctly based on your setup, you will lose network access to both the host and Oracle ILOM.

Readme

The readme is located in the `/opt/oracle/dcs/sample` directory. Review the readme carefully along with the provided JSON example files. Create a JSON file with the necessary changes based on your environment and requirements.

Example JSON Files to Create a Single Node Appliance with the CLI

Follow these JSON file examples to create a JSON file to deploy a single node appliance with the command `odacli create-appliance`.

Use the example JSON files and the information located in the readme as a template to create a file for your environment. Examples and the readme are located in the `/opt/oracle/dcs/sample` directory.

Note:

If you do not enter your network and Oracle ILOM information correctly based on your setup, then network access is lost to both the host and Oracle ILOM.

When using the example to create your JSON file, change the definitions to match your environment. The password must meet password requirements.

Example C-1 JSON File to Create a Single Node Oracle Database Appliance with Role Separation

The following is an example of a JSON file that creates a single node appliance on Oracle Database Appliance. The example uses role separation.

```
{
  "instance" : {
    "name" : "odambox",
    "instanceBaseName" : "odambox-c",
    "dbEdition" : "EE",
    "timeZone" : "UTC",
    "ntpServers" : ["10.0.3.14"],
    "dnsServers" : ["10.0.4.10", "10.0.4.11", "10.0.4.12"],
    "domainName" : "example.com",
    "isRoleSeparated" : true,
    "osUserGroup" : {
      "groups" : [ {
        "groupId" : 1001,
        "groupName" : "oinstall",
        "groupRole" : "oinstall"
      }, {
        "groupId" : 1002,
        "groupName" : "dbaoper",
        "groupRole" : "dbaoper"
      }, {
        "groupId" : 1003,
        "groupName" : "dba",
        "groupRole" : "dba"
      }, {
        "groupId" : 1004,
        "groupName" : "asmadmin",
        "groupRole" : "asmadmin"
      }, {
        "groupId" : 1005,
        "groupName" : "asmoper",
        "groupRole" : "asmoper"
      }, {
        "groupId" : 1006,
        "groupName" : "asmdba",
        "groupRole" : "asmdba"
      }
    ],
    "users" : [ {
      "userId" : 1000,
      "userName" : "oracle",
      "userRole" : "oracleUser"
    }, {
      "userId" : 1001,
      "userName" : "grid",
      "userRole" : "gridUser"
    }
  ]
},
  "nodes" : [ {
    "nodeNumber" : "0",
```

```

"nodeName" : "odambox",
"network" : [ {
  "nicName" : "btbond1",
  "ipAddress" : "10.0.1.11",
  "subNetMask" : "255.255.240.0",
  "gateway" : "10.0.0.1",
  "networkType" : [ "Public" ],
  "isDefaultNetwork" : true
},
],
"ilom" : {
  "ilomName": "odambox-c",
  "ipAddress": "10.0.2.10",
  "subNetMask": "255.255.240.0",
  "gateway": "10.0.0.1"
} ],
"grid" : {
  "diskGroup" : [ {
    "diskGroupName" : "DATA",
    "redundancy" : "NORMAL",
    "diskPercentage" : 80
  }, {
    "diskGroupName" : "RECO",
    "redundancy" : "NORMAL",
    "diskPercentage" : 20
  } ],
"scan" : {
  "scanName": "odambox-scan",
  "ipAddresses": [
    "10.0.1.11"
  ]
},
"vip": [
  {
    "nodeName": "0",
    "vipName": "odambox-vip",
    "ipAddress": "10.0.1.11"
  }
],
  "language" : "en",
  "enableAFD": "TRUE"
},
"database" : {
  "dbName" : "myTestDb",
  "databaseUniqueName": "myTestDb_sealkj",
  "dbEdition" : "EE",
  "dbVersion" : "12.2.0.1",
  "dbHomeId": null,
  "instanceOnly" : false,
  "isCdb" : true,
  "pdbName" : "pdb1",
  "pdbAdminuserName" : "pdbuser",
  "enableTDE": true,
  "adminPassword" : "password",

```

```

    "dbType" : "SI",
    "dbTargetNodeNumber" : null,
    "dbClass" : "OLTP",
    "dbShape" : "odbl",
    "dbStorage" : "ACFS",
    "dbCharacterSet" : {
      "characterSet" : "AL32UTF8",
      "nlsCharacterSet" : "AL16UTF16",
      "dbTerritory" : "AMERICA",
      "dbLanguage" : "AMERICAN"
    },
    "dbConsoleEnable" : false,
    "backupConfigId":null,
    "rmanBkupPassword": null
  },
  "asr" :{
    "asrType": "INTERNAL",
    "userName":"john.smith@example.com",
    "password":"password",
    "proxyServerName":"www-proxy.example.com",
    "proxyPort":"80",
    "proxyUserName":"proxy-user",
    "proxyPassword":"proxy-password",
    "snmpVersion":"v2"
  }
}

```

Example C-2 JSON File to Create a Single Node Oracle Database Appliance without Role Separation

The following is an example of a JSON file that creates an Oracle Database Appliance without using role separation. This example creates two groups (oinstall and dba) and one user ("oracle").

```

{
  "instance" : {
    "name" : "odambox",
    "instanceBaseName" : "odambox-c",
    "dbEdition" : "EE",
    "timeZone" : "UTC",
    "ntpServers" : ["10.0.3.14"],
    "dnsServers" : ["10.0.4.10","10.0.4.11","10.0.4.12"],
    "domainName" : "example.com",
    "isRoleSeparated" : false,
    "osUserGroup" : {
      "groups" : [ {
        "groupId" : 1001,
        "groupName" : "oinstall",
        "groupRole" : "oinstall"
      }, {
        "groupId" : 1002,
        "groupName" : "dba",
        "groupRole" : "dba"
      } ],
      "users" : [ {

```

```

        "userId" : 1000,
        "userName" : "oracle",
        "userRole" : "oracleUser"
    } ]
}
},
"nodes" : [ {
    "nodeNumber" : "0",
    "nodeName" : "odambox",
    "network" : [ {
        "nicName" : "btbond1",
        "ipAddress" : "10.0.1.11",
        "subNetMask" : "255.255.240.0",
        "gateway" : "10.0.0.1",
        "networkType" : [ "Public" ],
        "isDefaultNetwork" : true
    },
    ],
    "ilom" : {
        "ilomName": "odambox-c",
        "ipAddress": "10.0.2.10",
        "subNetMask": "255.255.240.0",
        "gateway": "10.0.0.1"
    }
} ],
"grid" : {
    "diskGroup" : [ {
        "diskGroupName" : "DATA",
        "redundancy" : "NORMAL",
        "diskPercentage" : 80
    }, {
        "diskGroupName" : "RECO",
        "redundancy" : "NORMAL",
        "diskPercentage" : 20
    } ],
    "scan" : {
        "scanName": "odambox-scan",
        "ipAddresses": [
            "10.0.1.11"
        ]
    },
    "vip": [
        {
            "nodeNumber": "0",
            "vipName": "odambox-vip",
            "ipAddress": "10.0.1.11"
        }
    ],
    "language" : "en",
    "enableAFD" : "TRUE"
},
"database" : {
    "dbName" : "myTestDb",
    "databaseUniqueName": "myTestDb_sealkj",
    "dbEdition" : "EE",

```

```

    "dbVersion" : "12.2.0.1",
    "dbHomeId":null,
    "instanceOnly" : false,
    "isCdb" : true,
    "pdBName" : "pdb1",
    "pdbAdminuserName" : "pdbuser",
    "enableTDE":true,
    "adminPassword" : "password",
    "dbType" : "SI",
    "dbTargetNodeNumber" : null,
    "dbClass" : "OLTP",
    "dbShape" : "odbl",
    "dbStorage" : "ACFS",
    "dbCharacterSet" : {
      "characterSet" : "AL32UTF8",
      "nlsCharacterSet" : "AL16UTF16",
      "dbTerritory" : "AMERICA",
      "dbLanguage" : "AMERICAN"
    },
    "dbConsoleEnable" : false,
    "backupConfigId":null,
    "rmanBkupPassword": null
  },
  "asr" :{
    "asrType": "INTERNAL",
    "userName":"john.smith@example.com",
    "password":"password",
    "proxyServerName":"www-proxy.example.com",
    "proxyPort":"80",
    "proxyUserName":"proxy-user",
    "proxyPassword":"proxy-password",
    "snmpVersion":"v2"
  }
}

```

Example JSON File to Create a Multi-Node Appliance with the CLI

Follow the JSON file example to create a JSON file to deploy a multi-node appliance with the command `odacli create-appliance`.

Use the example JSON files and the information located in the readme as a template to create a file for your environment. Examples and the readme are located in the `/opt/oracle/dcs/sample` directory.

Note:

It is important to review the readme and the examples carefully before creating your JSON file. If you do not enter your network and Oracle ILOM information correctly based on your setup, then network access is lost to both the host and Oracle ILOM.

Example C-3 JSON File to Create a Multi-Node Oracle Database Appliance with Role Separation

The following is an example of a JSON file that creates a multi-node appliance on Oracle Database Appliance bare metal platform. The example uses role separation. When using the example to create your JSON file, change the definitions to match your environment. The password must meet password requirements.

```
{
  "instance":{
    "name": "odahabox",
    "instanceBaseName": "odahabox",
    "dbEdition": "EE",
    "timeZone": "UTC",
    "ntpServers" : [ "10.0.3.14" ],
    "dnsServers" : [ "10.0.4.10", "10.0.4.11", "10.0.4.12" ],
    "domainName": "example.com",
    "isRoleSeparated": true,
    "osUserGroup": {
      "groups": [
        {
          "groupId": 1001,
          "groupName": "oinstall",
          "groupRole": "oinstall"
        },
        {
          "groupId": 1002,
          "groupName": "dbaoper",
          "groupRole": "dbaoper"
        },
        {
          "groupId": 1003,
          "groupName": "dba",
          "groupRole": "dba"
        },
        {
          "groupId": 1004,
          "groupName": "asmadmin",
          "groupRole": "asmadmin"
        },
        {
          "groupId": 1005,
          "groupName": "asmoper",
          "groupRole": "asmoper"
        },
        {
          "groupId": 1006,
          "groupName": "asmdba",
          "groupRole": "asmdba"
        }
      ],
      "users": [
        {
          "userId": 101,
          "userName": "grid",
```



```

        "userRole": "gridUser"
    },
    {
        "userId": 102,
        "userName": "oracle",
        "userRole": "oracleUser"
    }
]
},
"objectStoreCredentials": null
},
"nodes": [
    {
        "nodeNumber": "0",
        "nodeName": "odahaboxc1n2",
        "network": [
            {
                "nicName": "btbond1",
                "ipAddress": "10.31.98.133",
                "subNetMask": "255.255.240.0",
                "gateway": "10.31.96.1",
                "networkType": [
                    "Public"
                ],
                "isDefaultNetwork": true
            }
        ],
        "ilom": {
            "ilomName": "odahabox2-c",
            "ipAddress": "10.31.16.140",
            "subNetMask": "255.255.240.0",
            "gateway": "10.31.16.1"
        }
    },
    {
        "nodeNumber": "1",
        "nodeName": "odahaboxc1n1",
        "network": [
            {
                "nicName": "btbond1",
                "ipAddress": "10.31.98.132",
                "subNetMask": "255.255.240.0",
                "gateway": "10.31.96.1",
                "networkType": [
                    "Public"
                ],
                "isDefaultNetwork": true
            }
        ],
        "ilom": {
            "ilomName": "odahabox1-c",
            "ipAddress": "10.31.16.139",
            "subNetMask": "255.255.240.0",
            "gateway": "10.31.16.1"
        }
    }
]
}

```

```

    }
  ],
  "grid":{
    "diskGroup":[
      {
        "diskGroupName":"DATA",
        "redundancy":"HIGH",
        "diskPercentage":80
      },
      {
        "diskGroupName":"RECO",
        "redundancy":"HIGH",
        "diskPercentage":20
      },
      {
        "diskGroupName":"REDO",
        "redundancy":"HIGH",
        "diskPercentage":null
      }
    ],
    "scan":{
      "scanName":"odahaboxcl-scan",
      "ipAddresses":[
        "10.31.98.182",
        "10.31.98.183"
      ]
    },
    "vip":[
      {
        "nodeNumber":"0",
        "vipName":"odahaboxcln2-vip",
        "ipAddress":"10.31.98.159"
      },
      {
        "nodeNumber":"1",
        "vipName":"odahaboxcln1-vip",
        "ipAddress":"10.31.98.158"
      }
    ],
    "language":"en",
    "enableAFD":"TRUE"
  },
  "database":{
    "dbName":"myTestDb",
    "databaseUniqueName":"myTestDb_sealkj",
    "dbVersion":"12.2.0.1",
    "dbHomeId":null,
    "instanceOnly":false,
    "isCdb":true,
    "pdbName":"pdb1",
    "pdbAdminuserName":"pdbuser",
    "enableTDE":true,
    "adminPassword":"password",
    "dbType":"RAC",
    "dbTargetNodeNumber":null,

```

```
    "dbClass": "OLTP",  
    "dbShape": "odbl",  
    "dbStorage": "ACFS",  
    "dbCharacterSet": {  
        "characterSet": "AL32UTF8",  
        "nlsCharacterSet": "AL16UTF16",  
        "dbTerritory": "AMERICA",  
        "dbLanguage": "AMERICAN"  
    },  
    "dbConsoleEnable": false,  
    "backupConfigId": null  
  },  
  "asr": null  
}
```

D

Database Templates for Oracle Database Appliance

Use the information in this appendix to select database templates for your planned databases.

Topics:

- [Types of Database Templates for Oracle Database Appliance](#)
Choose a database template that best meets your database workload and hardware.

Types of Database Templates for Oracle Database Appliance

Choose a database template that best meets your database workload and hardware.

About Database Templates for Oracle Database Appliance

Oracle Database Appliance enables you to consolidate many databases into a single system. Consolidation can minimize idle resources, maximize efficiency, and lower costs. By using instance caging in conjunction with Oracle Database Resource Manager (the Resource Manager), you can provide desired levels of service across multiple instances on a single Oracle Database Appliance.

Oracle Database Appliance templates are already tuned for the size of each database instance workload. They are designed to run on a specific number of cores. Caging ensures that each database workload is restricted to the set of cores allocated by the template, enabling multiple databases to run concurrently with no performance degradation, up to the capacity of Oracle Database Appliance. You can select database template sizes larger than your current needs to provide for planned growth, which you accommodate later by adjusting System Global Area (SGA) and Program Global Area (PGA) sizes as well as the number of cores.

The Oracle Appliance Manager Configurator refers to the database sizing templates as *classes* of databases.

Note:

Oracle strongly recommends that you use the Oracle Database Appliance templates, because they implement best practices and are configured specifically for Oracle Database Appliance.

Use the following tables to help select the best templates for your databases. When using these tables remember that:

- The information in the tables assumes that you are creating disk backups. The information in the tables assume that you are creating local disk backups. Consider the space requirements for your database and the policy for local disk backups versus external backups. Typically, external backups have more space available for the database than local backups.
- Container databases are created on Oracle ACFS.
- I/O per second (I/Ops) values are derived from an 8-kilobyte random read-write response time of 10 to 12 milliseconds for Hard Disk Drives (HDDs), and less than 1 millisecond for Flash, for Oracle Database Appliance X5-2; 5 to 7 milliseconds for Oracle Database Appliance X4-2 and X3-2; and 5 milliseconds for Oracle Database Appliance Version 1 to service an online transaction processing (OLTP) I/O request. The rates are not based on the number of CPUs and assume that the system is running at capacity.
- Throughput, in megabytes per second (MBps) is based on a 1 MB sequential read/write for a data warehousing system. As with I/Ops, the MBps is a measure of throughput when the system is at capacity. With just a single small database running, the MBps would be the maximum available on the system for a large database.
- The log file size assumes four redo log groups for each instance with a log switch every 15 minutes when the system is running at full capacity.
- Storage is shared between the servers on Oracle Database Appliance.

About Improved Oracle Database Appliance Template Options

Oracle Appliance Manager provides improved database templates that are configured specifically for the type of database workload that you want to carry out on your databases on Oracle Database Appliance. Choose the template that best matches the common workload your databases perform (OLTP, DSS, In-Memory).

The improved Oracle Database templates replace the generic database templates from previous releases that only provided sizing parameters for OLTP workloads. The database sizing tables provide updated template names and sizing based on the number of CPUs and memory attributes for each type of database workload. The table “Oracle Database Appliance Database Template Name Conversions” provides a reference between the generic database template names and the database template names based on CPU cores.

Identify the template type that is appropriate to your database workload and hardware:

- Use Oracle Database Appliance OLTP Database Templates if your database workload is primarily online transaction processing (OLTP).
- Use Oracle Database Appliance DSS database templates if your database workload is primarily decision support services (DSS) or data warehousing.
- Use Oracle Database Appliance In-Memory (IMDB) database templates if your database workload can fit in memory, and can benefit from in-memory performance capabilities.
- Use Oracle Database Appliance X5-2 generic database templates if your database is on Oracle Database Appliance X5-2.
- Use Oracle Database Appliance X4-2 generic database templates if your database is on Oracle Database Appliance X4-2.

- Use Oracle Database Appliance X3-2 generic database templates if your database is on Oracle Database Appliance X3-2.
- Use Oracle Database Appliance Version 1 generic database templates if your appliance is the original model of Oracle Database Appliance.

The templates provide general guidelines about the maximum number of databases on a fully deployed Oracle Database Appliance. Base the memory and CPU sizing on the number of instances per server, not the number of databases. Memory and CPUs are shared by all databases and the number of databases impacts performance. For example, when you have one database, the database receives full I/O throughput. If you have 9 databases, then each database has only 1/9th of the available I/O throughput for all disks.

When you have multiple databases, they share and compete over available CPU resources. When choosing a template, do not have more CPU_COUNTs distributed than available threads in the system. Oracle recommends partitioning, where every database has exclusive CPUs. If you choose to exceed the recommended maximum number of databases on Oracle Database Appliance (over-provision), be aware of your I/O results and performance degradation. With the over-provisioned approach, the sum of the CPU_COUNT across all instances can exceed the number of CPUs. Better resource utilization is provided with over-provisioning; however, it is possible for contention to occur when multiple databases are heavily loaded at the same time. Over-provisioning is best used for systems running non-critical applications. Avoid using over-provisioning for databases with high I/O requirements or those with high transaction rates. If you choose to over-provision, then do not exceed twice the number of total CPUs. Twice the allocation of total CPUs is based on hyper-threading of 2 CPU threads per core.

Table D-1 Oracle Database Appliance Database Generic Template Name Conversions

CPU Core-Based Database Template Names	odb-01s	odb-01	odb-02	odb-04	odb-06	odb-12	odb-16	odb-24
Generic Database Template Names	Very, very small	Very Small	Small	Medium	Large	Extra Large	Extra Extra Large	Extra Extra Extra Large

 **Note:**

Extra Extra Large is applicable to Oracle Database Appliance X3-2 and Oracle Database Appliance X4-2. Extra Extra Extra Large is applicable to Oracle Database Appliance X4-2 only.

Table D-2 Oracle Database Appliance OLTP Database Template Sizes

Template	CPU Cores	SGA	PGA	Flash	Processes	LOG buffer, Redo Log
odb-01s (X5-2, X4-2, X3-2, and V1)	1	2 GB	1 GB	6 GB	200	16 MB, 1 GB
odb-01 (X5-2, X4-2, X3-2, and V1)	1	4 GB	2 GB	12 GB	200	16 MB, 1 GB

Table D-2 (Cont.) Oracle Database Appliance OLTP Database Template Sizes

Template	CPU Cores	SGA	PGA	Flash	Processes	LOG buffer, Redo Log
odb-02 (X5-2, X4-2, X3-2, and V1)	2	8 GB	4 GB	24 GB	400	16 MB, 1 GB
odb-04 (X5-2, X4-2, X3-2, and V1)	4	16 GB	8 GB	48 GB	800	32 MB, 1 GB
odb-06 (X5-2, X4-2, X3-2, and V1)	6	24 GB	12 GB	72 GB	1200	64 MB, 2 GB
odb-12 (X5-2, X4-2, X3-2, and V1)	12	48 GB	24 GB	144 GB	2400	64 MB, 4 GB
odb-16 (X5-2, X4-2, X3-2 Only)	16	64 GB	32 GB	192 GB	3200	64 MB, 4 GB
odb-24 (X5-2, X4-2 Only)	24	96 GB	48 GB	192 GB	4800	64 MB, 4 GB
odb-32 (X5-2 Only)	32	128 GB	64 GB	256 GB	6400	64 MB, 4 GB
odb-36 (X5-2 Only)	36	128 GB	64 GB	256 GB	7200	64 MB, 4 GB



Note:

Flash is applicable to Oracle Database Appliance X5-2 only.

Table D-3 Oracle Database Appliance DSS Database Template Sizes

Template	CPU Cores	SGA (GB)	PGA (GB)	Processes	Redo log file size (GB)	Log buffer (MB)
odb-01s (X5-2, X4-2, X3-2, and V1)	1	1	2	200	1	16
odb-01 (X5-2, X4-2, X3-2, and V1)	1	2	4	200	1	16
odb-02 (X5-2, X4-2, X3-2, and V1)	2	4	8	400	1	16
odb-04 (X5-2, X4-2, X3-2, and V1)	4	8	16	800	1	32
odb-06 (X5-2, X4-2, X3-2, and V1)	6	12	24	1200	2	64
odb-12 (X5-2, X4-2, X3-2, and V1)	12	24	48	2400	4	64
odb-16 (X5-2, X4-2, X3-2 Only)	16	32	64	3200	4	64
odb-24 (X5-2, X4-2 Only)	24	48	96	4800	4	64
odb-32 (X5-2 Only)	32	64	128	6400	4	64
odb-36 (X5-2 Only)	36	64	128	7200	4	64

Table D-4 Oracle Database Appliance In-Memory Database Template Size

Template	CPU Cores	SGA (GB)	PGA (GB)	In-Memory (GB)	Processes	Redo log file size (GB)	Log buffer (MB)
odb-01s (X5-2, X4-2, X3-2, and V1)	1	2	1	1	200	1	16
odb-01 (X5-2, X4-2, X3-2, and V1)	1	4	2	2	200	1	16
odb-02 (X5-2, X4-2, X3-2, and V1)	2	8	4	4	400	1	16
odb-04 (X5-2, X4-2, X3-2, and V1)	4	16	8	8	800	1	32
odb-06 (X5-2, X4-2, X3-2, and V1)	6	24	12	12	1200	2	64
odb-12 (X5-2, X4-2, X3-2, and V1)	12	48	24	24	2400	4	64
odb-16 (X5-2, X4-2, X3-2 Only)	16	64	32	32	3200	4	64
odb-24 (X5-2, X4-2 Only)	24	96	48	48	4800	4	64
odb-32 (X5-2 Only)	32	128	64	64	6400	4	64
odb-36 (X5-2 Only)	36	128	64	64	7200	4	64

Table D-5 Oracle Database Appliance X5-2 Database Template Size Storage Performance

Template	Number of databases that you can deploy using this template	Container Database ACFS Size on DATA Disk Group (GB)	I/Ops with single storage shelf (HDD/FLASH)	Throughput (MBps) with single storage shelf (HDD/FLASH)	I/Ops with storage shelf plus storage expansion shelf (HDD/FLASH)	Throughput (MBps) with storage shelf plus storage expansion shelf (HDD/FLASH)	Log generation (MBps)
odb-01s	36	100	42/4167	83/83	83/8333	167/167	6.83
odb-01	36	100	42/4167	83/83	83/8333	167/167	6.83
odb-02	18	200	83/8.3K	167/167	167/16.7K	333/333	6.83
odb-04	9	400	167/16.7K	333/333	333/33.3K	667/667	13.65
odb-06	6	800	250/25K	500/500	500/50K	1000/1000	27.3
odb-12	3	1600	500/50K	1000/1000	1000/100K	2000/2000	27.3
odb-16	2	1600	750/75K	1500/1500	1500/150K	3000/3000	27.3
odb-24	1	1600	1500/150K	3000/3000	3000/300K	6000/6000	27.3
odb-32	1	1600	1500/150K	3000/3000	3000/300K	6000/6000	27.3
odb-36	1	1600	1500/150K	3000/3000	3000/300K	6000/6000	27.3

 **Note:**

The number of databases that you can deploy using this template is for the entire Oracle Database Appliance.

Actual I/O per second (I/Ops) and throughput for a database depends on the percentage of I/O operations that are serviced through the FLASH, compared with the operations serviced through the hard disk drives (HDDs). The I/Ops weighting in these tables assumes an OLTP workload calculated as a mixed workload (80 percent reads, serviced through the FLASH cache, and 20 percent writes serviced through the HDDs).

Table D-6 Oracle Database Appliance X4-2 Database Template Size Storage Performance

Template	Number of databases that you can deploy using this template	Container Database ACFS Size on DATA Disk Group (GB)	I/Ops with single storage shelf	Throughput (MBps) with single storage shelf	I/Ops with storage shelf plus storage expansion shelf	Throughput (MBps) with storage shelf plus storage expansion shelf	Log generation (MBps)
odb-01s	24	100	138	146	275	229	6.83
odb-01	24	100	138	146	275	230	6.83
odb-02	12	200	275	292	550	458	6.83
odb-04	6	400	550	583	1100	917	13.65
odb-06	4	800	825	875	1650	1375	27.3
odb-12	2	1600	1650	1750	3300	2750	27.3
odb-16	1	1600	3300	3500	6600	5500	27.3
odb-24	1	1600	3300	3500	6600	5500	27.3

Table D-7 Oracle Database Appliance X3-2 Database Template Size Storage Performance

Template	Number of databases that you can deploy using this template	Container Database ACFS Size on DATA Disk Group (GB)	I/Ops with single storage shelf	Throughput (MBps) with single storage shelf	I/Ops with storage shelf plus storage expansion shelf	Throughput (MBps) with storage shelf plus storage expansion shelf	Log generation (MBps)
odb-01s	16	100	206	219	413	344	6.83
odb-01	16	100	206	219	413	344	6.83
odb-02	8	200	413	438	825	688	6.83
odb-04	4	400	825	875	1650	1375	13.65
odb-06	2	800	1650	1750	3300	2750	27.3
odb-12	1	1600	3300	3500	6600	5500	27.3
odb-16	1	1600	3300	3500	6600	5500	27.3

Table D-8 Oracle Database Appliance Version 1 Database Template Size Storage Performance

Template	Number of databases that you can deploy using this template	Container Database ACFS Size on DATA Disk Group (GB)	I/Ops	Throughput (MBps)	Log generation (Mps)
odb-01s	12	100	333	250	6.83
odb-01	12	100	333	250	6.83
odb-02	6	200	667	500	6.83
odb-04	3	400	1333	1000	13.65
odb-06	2	800	2000	1500	27.3
odb-12	1	1600	4000	3000	27.3

 **Note:**

For a single database, select a template that best fits your expected workload (the CPU and I/Ops capabilities you require) on the hardware that you are using. When creating multiple databases, calculate the overall workload; available system resources for any new database are affected by the CPU and I/Ops consumed by the existing databases that are already on the system.

Index

A

ACFS, [B-4–B-6](#)
ACFS mount points, [B-5](#)
ACR, [16-18](#)
administrative account users, [8-1](#)
administrative accounts, [8-1](#)
agent
 update, [14-39–14-42](#)
agent proxy setting, [10-10](#)
ASM, [B-4](#)
ASM Cluster File System
 See Oracle ACFS
ASR
 configure, [14-156](#)
 delete, [14-157](#)
 details, [14-158](#)
 test, [14-159](#)
 update, [14-160](#)
Automatic Storage Management
 See Oracle ASM

B

back up database, [10-13](#)
backup and recovery
 CLI commands, [14-55](#)
 RMAN, [8-2](#)
backup databases, [10-2](#)
backup file location
 configurator, [2-10](#)
backup policy, [10-16](#), [10-17](#)
 update, [10-13](#)
backup to external FRA, [10-11](#)
backup to internal FRA, [10-11](#)
backup to NFS location, [10-11](#)
backup to Object Store, [10-11](#)
bare metal patching, [6-5](#), [6-11](#)
bill of materials, [16-7](#)
Browser User Interface, [C-1](#)
 about, [1-5](#)
 actions, [1-5](#)
BUI
 clone vdisk, [13-25](#)
 clone vm, [13-30](#)

BUI (continued)

create CPU pool, [12-3](#)
create dbsystem, [13-8](#)
create vdisk, [13-24](#)
create vm, [13-28](#)
create vmstorage, [13-17](#)
create vnetwork, [13-20](#)
delete cpupool, [12-5](#)
delete dbsystem, [13-15](#)
delete vdisk, [13-27](#)
delete vm, [13-33](#)
delete vnetwork, [13-23](#)
delete-vmstorage, [13-19](#)
describe CPU pool, [12-4](#)
describe dbsystem, [13-13](#)
describe storage, [13-18](#)
describe vdisk, [13-25](#)
describe vm, [13-32](#)
describe vnetwork, [13-21](#)
list dbsystems, [13-12](#)
modify cpupool, [12-4](#)
modify vdisk, [13-26](#)
modify vm, [13-31](#)
modify vmstorage, [13-18](#)
modify vnetwork, [13-22](#)
start dbsystem, [13-13](#)
start vm, [13-32](#)
start vnetwork, [13-22](#)
stop dbsystem, [13-14](#)

C

cabling, [3-2](#)
 Oracle Database Appliance model X4-2 and X3-2, [3-3](#)
 Oracle Database Appliance model X5-2, [3-2](#)
 validate, [14-173](#)
checklist
 for system requirements, [2-6](#)
 tasks to complete before deployment, [2-1](#)
cleanup, [6-17](#)
cleanup utility, [7-1](#)
cleanup.pl, [7-1](#), [16-11](#)
CLI commands
 configure, [14-8](#)

cloning database, [8-13](#), [8-14](#)
 Cluster Time Synchronization Service
 See CTSS
 Configuration Audit Tool (ORAchk), [16-13](#)
 configure CLI commands
 configure-firstnet, [14-8](#)
 configure-firstnet, [4-1](#)
 CPU
 commands, [14-90](#)
 CPU core
 current configuration, [14-91](#)
 enable, [14-91](#)
 CPU cores
 configuration history, [14-90](#)
 list, [14-90](#)
 cpu pool
 creating, [12-3](#)
 CPU pool
 audit record, [12-6](#)
 deleting, [12-5](#)
 modifying, [12-4](#)
 over-subscribed, [12-6](#)
 viewing, [12-4](#)
 cpu pools
 about, [12-1](#)
 cpupool
 create, [14-93](#), [15-23](#)
 delete, [14-95](#), [15-25](#)
 describe, [14-94](#), [15-24](#)
 modify, [14-95](#), [15-25](#)
 cpupools
 auditrecord, [14-96](#), [14-97](#), [15-26](#), [15-27](#)
 list, [14-94](#), [15-24](#)
 create appliance, [4-8](#)
 CTSS (Cluster Time Synchronization Service),
 [2-7](#)

D

database, [2-10](#), [8-18](#), [D-1](#)
 backup policy, [10-12](#)
 block size
 configurator, [2-10](#)
 clone from backup, [8-11](#)
 consolidate multiple, [D-1](#)
 create, [8-7](#)
 delete, [8-17](#), [8-20](#)
 details, [8-6](#)
 home, [8-18](#)
 create multiple, [8-18](#)
 multiple, [8-18](#)
 language
 configurator, [2-10](#)
 list, [8-6](#)
 modify, [8-15](#)
 database (*continued*)
 move, [8-16](#)
 register, [14-114](#)
 shape
 See shape, database
 template
 See shape, database
 territory
 configurator, [2-10](#)
 upgrade, [8-17](#)
 database backup
 delete, [10-14](#)
 database home
 create, [8-19](#)
 details, [8-19](#)
 display details, [14-120](#)
 list, [8-19](#)
 Database Security Assessment report, [16-14](#)
 database storage, [B-1](#), [B-4](#)
 commands, [14-122](#)
 create, [14-123](#)
 display details, [14-124](#), [14-125](#)
 list, [14-128](#)
 database system
 creating, [13-8](#)
 delete, [13-15](#)
 describing, [13-13](#)
 start, [13-13](#)
 stop, [13-14](#)
 database systems
 list, [13-12](#)
 database template
 See template, database
 database templates, [D-1](#)
 database, register, [8-24](#)
 dbsystem
 create, [15-4](#)
 delete, [15-14](#)
 describe, [15-6](#), [15-12](#)
 start, [15-13](#)
 stop, [15-13](#)
 dbsystems
 list, [15-5](#)
 default groups and users, [A-3](#)
 deleting backups, [10-25](#)
 DHCP (Dynamic Host Configuration Protocol)
 connect to Oracle ILOM, [3-14](#)
 Oracle ILOM configuration, [3-14](#)
 directory paths, [A-1](#)
 disk group sizes, [A-3](#)
 disk group storage
 describe, [14-126](#)
 list, [14-129](#)
 DNS
 See domain name system

domain
 definition, [13-3](#)
 domain name system, [2-7](#)
 downloading software, [4-6](#)
 Dynamic Host Configuration Protocol
 See DHCP

E

electrical power cords
 connecting, [3-11](#)
 EM Express, [8-26](#)
 external FRA, [10-2](#)

F

fiber connections, [3-5](#)
 flex diskgroup, [8-7](#), [8-15](#)

G

Grid user, [8-1](#)
 groups, [2-4](#)
 groups and users defaults, [A-3](#)
 guest virtual machine
 definition, [13-3](#)

H

Host Public Addresses
 IP address, [2-11](#)

I

InfiniBand, [3-5](#)
 replacing cards, [3-13](#)
 InfiniBand interconnect cabling, [3-2](#)
 install software, [4-7](#)
 installed version
 display, [14-22](#), [14-24](#), [14-25](#), [14-31](#), [14-36](#)
 instance caging, [8-25](#)
 enable, [8-25](#)
 template, [D-1](#)
 Integrated Lights Out Manager
 See Oracle ILOM
 interconnect cables
 attach, [3-2](#)
 storage expansion shelf, [3-7](#)
 internal FRA, [10-2](#)

J

JSON file, [13-34](#), [13-36](#), [C-2](#), [C-7](#)

K

keyboard
 adding, [3-10](#)
 KVM, [15-1](#), [15-3](#)
 definition, [13-3](#)
 deploying, [13-16](#)
 KVM commands
 odacli clone-vdisk, [15-21](#)
 odacli clone-vm, [15-37](#)
 odacli create-cpupool, [14-93](#), [15-23](#)
 odacli create-dbsystem, [15-4](#)
 odacli create-vdisk, [15-19](#)
 odacli create-vm, [15-32](#)
 odacli create-vmstorage, [15-16](#)
 odacli create-vnetwork, [15-28](#)
 odacli delete-cpupool, [14-95](#), [15-25](#)
 odacli delete-dbsystem, [15-14](#)
 odacli delete-vdisk, [15-21](#)
 odacli delete-vm, [15-38](#)
 odacli delete-vmstorage, [15-18](#)
 odacli delete-vnetwork, [15-31](#)
 odacli describe-auditrecord, [14-97](#), [15-27](#)
 odacli describe-cpupool, [14-94](#), [15-24](#)
 odacli describe-dbsystem, [15-6](#)
 odacli describe-dbsystem-image, [15-12](#)
 odacli describe-vdisk, [15-20](#)
 odacli describe-vm, [15-34](#)
 odacli describe-vmstorage, [15-17](#)
 odacli describe-vnetwork, [15-29](#)
 odacli list-auditrecords, [14-96](#), [15-26](#)
 odacli list-cpupools, [14-94](#), [15-24](#)
 odacli list-dbsystems, [15-5](#)
 odacli list-vdisks, [15-20](#)
 odacli list-vms, [15-34](#)
 odacli list-vmstorages, [15-17](#)
 odacli list-vnetworks, [15-29](#)
 odacli migrate-vm, [15-37](#)
 odacli modify-cpupool, [14-95](#), [15-25](#)
 odacli modify-vdisk, [15-20](#)
 odacli modify-vm, [15-34](#)
 odacli modify-vmstorage, [15-18](#)
 odacli modify-vnetwork, [15-31](#)
 odacli start-dbsystem, [15-13](#)
 odacli start-vm, [15-36](#)
 odacli start-vnetwork, [15-30](#)
 odacli stop-dbsystem, [15-13](#)
 odacli stop-vm, [15-36](#)
 odacli stop-vnetwork, [15-30](#)

L

LED
 status when blinking, [3-11](#)
 status when steady, [3-11](#)

LED (*continued*)
 status when steady on, [3-11](#)

Linux
 and virtualization, [13-2](#), [13-6](#)

listener.ora, configure, [8-21](#)

load configuration, [C-1](#)

log files, [A-2](#)
 sending to Oracle Support Services, [16-29](#)

log switch
 select template, [D-1](#)

logs
 storage diagnostic, [14-47](#), [14-148](#)

M

migration
 from an existing database, [8-2](#)

monitor
 adding, [3-10](#)

mouse
 adding, [3-10](#)

multiple database instances
 instance caging, [8-25](#)

multiple Oracle homes, [8-18](#)
 create, [8-18](#)

My Oracle Support, [16-29](#)
 hardware SI, [2-1](#)
 send log files for troubleshooting, [16-29](#)

N

network
 configure, [14-8](#)

network planning, [2-7](#)

network time protocol service (NTP service)
 configurator, [2-10](#)

NFS backup, [10-9](#)

NTP service
 See network time protocol service

O

oakcli commands
 show power
 example, [16-22](#)

Object Store, [10-10](#)
 credentials, [14-60](#), [14-64](#), [14-70](#), [14-78](#)

odaadmcli commands
 expand storage, [14-170](#)
 hardware configuration, [14-163](#)
 hardware monitoring, [14-163](#)
 manage diagcollect, [14-148](#), [16-29](#)
 orachk, [14-47](#)
 power disk, [14-173](#)
 show controller, [14-174](#)

odaadmcli commands (*continued*)
 show cooling, [14-164](#)
 show disk, [14-175](#)
 show diskgroup, [14-176](#)
 show env_hw, [14-164](#)
 show fs, [14-165](#)
 show memory, [14-166](#)
 show network, [14-166](#)
 show power, [14-167](#)
 show processor, [14-168](#)
 show raidsyncstatus, [14-177](#)
 show server, [14-169](#)
 show storage, [14-178](#)
 storage, [14-169](#)
 stordiag, [14-179](#)

odacli cleanup-patchrepo, [6-17](#)

odacli commands
 appliance, [14-48](#)
 apply patch, [14-19](#)
 backup, [14-55](#)
 cleanup-patchrepo, [14-20](#)
 clone-database, [14-98](#)
 clone-vdisk, [13-25](#)
 clone-vm, [13-30](#)
 configure-asr, [14-156](#)
 configure-dataguard, [14-80](#)
 CPU core, [14-90](#)
 cpu pool, [14-92](#), [15-22](#)
 create database, [8-18](#)
 create vdisk, [13-24](#)
 create-appliance, [14-49](#)
 create-auto-logclean-policy, [14-149](#)
 create-backup, [14-57](#)
 create-backupconfig, [14-59](#)
 create-cpupool, [12-3](#)
 create-database, [14-101](#)
 create-dbhome, [14-119](#)
 create-dbstorage, [14-123](#)
 create-dbsystem, [13-8](#)
 create-jobdata-retention-policy, [14-133](#)
 create-logcleanjob, [14-150](#)
 create-network, [14-10](#)
 create-objectstoreswift, [14-60](#)
 create-prepatchreport, [14-22](#)
 create-purge-jobdata-job, [14-135](#)
 create-vm, [13-28](#)
 create-vmstorage, [13-17](#)
 create-vnetwork, [13-20](#)
 database, [14-98](#)
 database storage, [14-122](#)
 dataguard, [14-79](#)
 DBHome, [14-119](#)
 dbsystem, [15-3](#)
 deconfigure-dataguard, [14-85](#)
 delete-asr, [14-157](#)

odacli commands (*continued*)

- delete-backup, [14-61](#)
- delete-backupconfig, [14-62](#)
- delete-cpupool, [12-5](#)
- delete-database, [14-106](#)
- delete-dbhome, [14-120](#)
- delete-dbstorage, [14-124](#)
- delete-dbsystem, [13-15](#)
- delete-jobdata-retention-policy, [14-139](#)
- delete-network, [14-11](#)
- delete-networkinterface, [14-13](#)
- delete-objectstoreswift, [14-64](#)
- delete-prepatchreport, [14-24](#)
- delete-vdisk, [13-27](#)
- delete-vm, [13-33](#)
- delete-vmstorage, [13-19](#)
- delete-vnetwork, [13-23](#)
- describe-asr, [14-158](#)
- describe-backupreport, [14-63](#)
- describe-component, [14-25](#)
- describe-cpucore, [14-91](#)
- describe-cpupool, [12-4](#)
- describe-database, [14-107](#)
- describe-dataguardstatus, [14-86](#)
- describe-dbhome, [14-121](#)
- describe-dbstorage, [14-125](#)
- describe-dbsystem, [13-13](#)
- describe-dgstorage, [14-126](#)
- describe-job, [14-140](#)
- describe-latestpatch, [14-29](#)
- describe-logcleanjob, [14-152](#)
- describe-network, [14-14](#)
- describe-networkinterface, [14-15](#)
- describe-prepatchreport, [14-31](#)
- describe-schedule, [14-65](#)
- describe-system, [14-50](#)
- describe-vdisk, [13-25](#)
- describe-vm, [13-32](#)
- describe-vmstorage, [13-18](#)
- describe-vnetwork, [13-21](#)
- failover-dataguard, [14-87](#)
- irestore-database, [14-65](#)
- jobs, [14-133](#)
- list scheduler jobs, [14-146](#)
- list-auto-logclean-policy, [14-153](#)
- list-backupconfig, [14-69](#)
- list-backupreports, [14-70](#)
- list-cpucores, [14-90](#)
- list-cpupools, [12-4](#)
- list-databases, [14-108](#)
- list-dataguardstatus, [14-88](#)
- list-dbhomes, [14-121](#)
- list-dbstorages, [14-128](#)
- list-dbsystems, [13-12](#)
- list-dgdisks, [14-171](#)

odacli commands (*continued*)

- list-featuretracking, [14-53](#)
- list-jobdata-retention-policy, [14-144](#)
- list-jobs, [14-141](#)
- list-logcleanjobs, [14-154](#)
- list-logspaceusage, [14-154](#)
- list-networkinterfaces, [14-17](#)
- list-networks, [14-16](#)
- list-osconfigurations, [14-161](#)
- list-prepatchreports, [14-36](#)
- list-purge-jobdata-job, [14-145](#)
- list-scheduled-executions, [14-146](#)
- list-schedules, [14-71](#)
- list-tdebackupreports, [14-72](#)
- list-vdisks, [13-25](#)
- list-vms, [13-32](#)
- list-vmstorages, [13-18](#)
- list-vnetworks, [13-21](#)
- modify-cpupool, [12-4](#)
- modify-database, [14-109](#)
- modify-dbstorage, [14-130](#)
- modify-vdisk, [13-26](#)
- modify-vm, [13-31](#)
- modify-vmstorage, [13-18](#)
- modify-vnetwork, [13-22](#)
- move-database, [14-113](#)
- network, [14-7](#)
- odacli create-appliance, [C-2](#), [C-7](#)
- odacli create-dbsystem, [13-34](#), [13-36](#)
- odacli delete-agentconfig-parameters, [14-23](#)
- odacli list-agentconfig-parameters, [14-34](#)
- odacli list-availablepatches, [14-35](#)
- odacli list-dgstorages, [14-129](#)
- odacli list-objectstoreswifts, [14-70](#)
- odacli update-agentconfig-parameters, [14-37](#)
- Oracle ASR, [14-155](#)
- OS, [14-161](#)
- recover-database, [14-73](#)
- recovery, [14-55](#)
- register-database, [14-114](#)
- reinstate-dataguard, [14-88](#)
- restore-archivelog, [14-75](#)
- restore-tdewallet, [14-75](#)
- set-credential, [14-48](#)
- show -h
 - with Oracle Database Appliance Hardware Monitoring Tool, [16-22](#)
- start-dbsystem, [13-13](#)
- start-vm, [13-32](#)
- start-vnetwork, [13-22](#)
- stop-dbsystem, [13-14](#)

- odacli commands (*continued*)
 - stop-vm, [13-32](#)
 - stop-vnetwork, [13-22](#)
 - storage, [14-169](#)
 - switchover-dataguard, [14-89](#)
 - test-asr, [14-159](#)
 - update, [14-19](#)
 - update database home, [14-39](#)
 - update repository, [14-44](#)
 - update-asr, [14-160](#)
 - update-backupconfig, [14-76](#)
 - update-cpucore, [14-91](#)
 - update-dcsadmin, [14-39](#)
 - update-dcsagent, [14-40](#)
 - update-dcscomponents, [14-41](#)
 - update-dgstorage, [14-132](#)
 - update-network, [14-18](#)
 - update-objectstoreswift, [14-78](#)
 - update-osconfigurations, [14-162](#)
 - update-registry, [14-42](#)
 - update-schedule, [14-79](#)
 - update-server, [14-45](#)
 - update-storage, [14-46](#)
 - upgrade-database, [14-117](#)
 - validate storage topology, [14-173](#)
 - validate-storagetopology, [14-173](#)
 - vdisk, [15-18](#)
 - vm, [15-32](#)
 - vmstorage, [15-16](#)
 - vnetwork, [15-28](#)
- odacli create-appliance
 - example JSON files, [C-2](#), [C-7](#)
 - readme, [C-2](#)
- odacli create-dbsystem
 - example JSON files, [13-34](#), [13-36](#)
- odaeraser.py, [7-5](#)
- OINSTALL group, [8-1](#)
- operating system users, [2-4](#)
- Optimal Flexible Architecture
 - and Oracle homes, [A-1](#)
- ORAchk report, [16-14](#)
- Oracle ACFS, [13-3](#)
- Oracle ACFS (Oracle Automatic Storage Management Cluster File System)
 - virtual storage, [13-3](#)
- Oracle ASM (Oracle Automatic Storage Management)
 - add storage expansion shelf, [3-6](#)
 - data migration, [8-2](#)
 - user group, [A-3](#)
- Oracle ASR
 - commands, [14-155](#)
 - configure, [14-156](#)
- Oracle ASR (Oracle Auto Service Request)
 - configurator, [2-10](#)
- Oracle Automatic Storage Management
 - See Oracle ASM
- Oracle Cloud File System
 - configurator, [2-10](#)
- Oracle Data Guard, [11-1](#)
 - active data guard, [11-22](#)
 - CLI commands, [14-79](#)
 - configure, [11-2](#)
 - deconfigure, [11-23](#)
 - failover, [11-13](#)
 - migrating, [11-15](#)
 - network, [11-14](#)
 - patching, [11-20](#)
 - reinstate, [11-13](#)
 - status, [11-12](#)
 - switchover, [11-13](#)
 - upgrade database, [11-21](#)
- Oracle Database
 - See database
- Oracle Database Appliance Hardware Monitoring Tool, [16-22](#)
- Oracle Database Appliance Manager
 - software inventory, [1-3](#)
- Oracle Database Enterprise Edition
 - overview, [2-2](#)
- Oracle Database Resource Manager
 - instance caging, [8-25](#)
- Oracle Enterprise Manager Database Express, [8-26](#)
- Oracle home
 - multiple, [8-18](#)
- Oracle ILOM (Oracle Integrated Lights Out Manager)
 - configurator, [2-10](#)
 - configure, [3-14](#)
- Oracle Integrated Lights Out Manager
 - See Oracle ILOM
- Oracle Ksplice, [6-13](#)
- Oracle KVM, [13-2](#), [13-6](#)
- Oracle KVM command-line interface
 - alphabetical list of commands, [15-1](#)
- Oracle ORAchk, [16-20](#)
- Oracle ORAchk Health Check Tool, [16-13](#)
- Oracle RAC (Oracle Real Application Clusters), [2-2](#)
 - deployment option, [2-2](#)
 - See also Oracle RAC One Node
- Oracle RAC One Node, [2-2](#)
 - deployment option, [2-2](#)
- Oracle Real Application Clusters
 - See Oracle RAC
- Oracle Support Services
 - See My Oracle Support
- Oracle Trace File Analyzer Collection, [16-19](#)
- Oracle user, [8-1](#)

OS configuration
 current, [14-161](#), [14-162](#)
 suggested, [14-161](#), [14-162](#)
 OSASM group, [8-1](#)
 OSDBA, [8-1](#)
 OSDBA for ASM group, [8-1](#)
 OSDBA group, [8-1](#)
 OSOPER groups, [8-1](#)
 over-subscribed CPU pool, [12-6](#)

P

patches
 software inventory, [1-3](#)
 patching
 appliance, [6-1](#)
 using Browser User Interface, [6-9](#), [6-12](#)
 patching Oracle Database Appliance, [6-5](#), [6-11](#)
 performance tuning, [12-6](#)
 plumb network, [4-1](#)
 power cords
 connecting, [3-11](#)
 processor_group_name, [12-1](#)
 proxy setting, [10-10](#)
 public network interface, defining, [3-13](#)

R

readme, [C-2](#)
 recover database, [10-20](#)
 recovering database, [10-14](#)
 redundancy level
 disk group
 configurator, [2-10](#)
 reimage appliance, [7-4](#)
 resource management
 CPU pools, [12-6](#)
 Oracle KVM, [13-2](#), [13-6](#)
 supported virtual operating systems, [13-2](#),
[13-6](#)
 restore archivelog, [10-25](#)
 restore baremetal system, [7-4](#)
 restore database, [10-22](#)
 RMAN (Recovery Manager utility)
 database management, [8-2](#)
 RPM drift, [16-7](#)

S

sanitize diagnostics, [16-18](#)
 SAP user and group configuration, [2-4](#)
 save configuration, [C-1](#)
 SCAN (single client access name), [2-7](#)
 no NIS support, [2-7](#)

scheduler
 jobs, [14-146](#)
 Scheduling Database Backups, [10-19](#)
 secure erase tool, [7-5](#)
 odaeraser.py, [7-5](#)
 sending log files to Oracle Support Services,
[16-29](#)
 setupX4network.pl, [3-13](#)
 shape
 database
 select, [2-3](#)
 SI (Support Identifier)
 add to profile, [2-1](#)
 register, [2-1](#)
 software
 license registration, [2-1](#)
 space management, [B-5](#), [B-6](#)
 SQL*Loader, [8-2](#)
 Standard Edition High Availability, [8-3](#)
 static listener, configure, [8-21](#)
 storage, [9-1](#)
 storage expansion shelf
 adding, [3-6](#)
 storage planning, [2-7](#)
 support identifier
 See SI
 system requirements
 checklist, [2-6](#)

T

TDE, [8-4](#)
 template
 database
 choosing, [D-1](#)
 select, [2-3](#)
 templates, [D-1](#)
 TFA command, [16-15](#)
 TFA options, [16-15](#)
 Trace File Analyzer (TFA) Collector, [16-15](#)
 troubleshooting, [16-2](#), [16-11](#)
 log files for Oracle Support Services, [16-29](#)
 turning on Oracle Database Appliance, [3-11](#)

U

uninstall, [7-1](#)
 update-dcscomponents, [16-2](#)
 upgrade
 database, [6-18](#)
 user role separation, [2-4](#)

V

viewing backup reports, [10-14](#)

- virtual disk
 - clone, [15-21](#)
 - cloning, [13-25](#)
 - create, [15-19](#)
 - creating, [13-24](#)
 - delete, [15-21](#)
 - deleting, [13-27](#)
 - describe, [15-20](#)
 - list, [15-20](#)
 - modify, [15-20](#)
 - modifying, [13-26](#)
 - viewing, [13-25](#)
- virtual disks, [13-3](#)
- virtual IP address (virtual Internet Protocol address)
 - subnet, [2-7](#)
- virtual machine
 - about, [13-3](#)
 - assemblies, [13-3](#)
 - clone, [15-37](#)
 - cloning, [13-30](#)
 - create, [15-32](#)
 - creating, [13-28](#)
 - delete, [15-38](#)
 - deleting, [13-33](#)
 - describe, [15-34](#)
 - list, [15-34](#)
 - migrate, [15-37](#)
 - modify, [15-34](#)
 - modifying, [13-31](#)
 - start, [13-32](#), [15-36](#)
 - stop, [13-32](#), [15-36](#)
 - templates, [13-3](#)
 - viewing, [13-32](#)
- virtual network
 - creating, [13-20](#)

- virtual network (*continued*)
 - deleting, [13-23](#)
 - modifying, [13-22](#)
 - start, [13-22](#)
 - stop, [13-22](#)
 - viewing, [13-21](#)
- virtual storage
 - about, [13-3](#)
- virtualization, [13-2](#), [13-6](#)
- vm storage
 - creating, [13-17](#)
 - deleting, [13-19](#)
 - modifying, [13-18](#)
 - viewing, [13-18](#)
- vmstorage
 - create, [15-16](#)
 - delete, [15-18](#)
 - describe, [15-17](#)
 - modify, [15-18](#)
- vmstorages
 - list, [15-17](#)
- vnetwork
 - create, [15-28](#)
 - delete, [15-31](#)
 - describe, [15-29](#)
 - modify, [15-31](#)
 - start, [15-30](#)
 - stop, [15-30](#)
- vnetworks
 - list, [15-29](#)

W

- web interface
 - Oracle Enterprise Manager Database Express, [8-26](#)