

Oracle® Communications

EAGLE Database Administration- GTT User's Guide



Release 46.9

F27971-02

March 2021

The Oracle logo, consisting of a solid red square with the word "ORACLE" in white, uppercase, sans-serif font centered within it.

ORACLE®

F27971-02

Copyright © 1993, 2021, Oracle and/or its affiliates.

This software and related documentation are provided under a license agreement containing restrictions on use and disclosure and are protected by intellectual property laws. Except as expressly permitted in your license agreement or allowed by law, you may not use, copy, reproduce, translate, broadcast, modify, license, transmit, distribute, exhibit, perform, publish, or display any part, in any form, or by any means. Reverse engineering, disassembly, or decompilation of this software, unless required by law for interoperability, is prohibited.

The information contained herein is subject to change without notice and is not warranted to be error-free. If you find any errors, please report them to us in writing.

If this is software or related documentation that is delivered to the U.S. Government or anyone licensing it on behalf of the U.S. Government, then the following notice is applicable:

U.S. GOVERNMENT END USERS: Oracle programs (including any operating system, integrated software, any programs embedded, installed or activated on delivered hardware, and modifications of such programs) and Oracle computer documentation or other Oracle data delivered to or accessed by U.S. Government end users are "commercial computer software" or "commercial computer software documentation" pursuant to the applicable Federal Acquisition Regulation and agency-specific supplemental regulations. As such, the use, reproduction, duplication, release, display, disclosure, modification, preparation of derivative works, and/or adaptation of i) Oracle programs (including any operating system, integrated software, any programs embedded, installed or activated on delivered hardware, and modifications of such programs), ii) Oracle computer documentation and/or iii) other Oracle data, is subject to the rights and limitations specified in the license contained in the applicable contract. The terms governing the U.S. Government's use of Oracle cloud services are defined by the applicable contract for such services. No other rights are granted to the U.S. Government.

This software or hardware is developed for general use in a variety of information management applications. It is not developed or intended for use in any inherently dangerous applications, including applications that may create a risk of personal injury. If you use this software or hardware in dangerous applications, then you shall be responsible to take all appropriate fail-safe, backup, redundancy, and other measures to ensure its safe use. Oracle Corporation and its affiliates disclaim any liability for any damages caused by use of this software or hardware in dangerous applications.

Oracle and Java are registered trademarks of Oracle and/or its affiliates. Other names may be trademarks of their respective owners.

Intel and Intel Inside are trademarks or registered trademarks of Intel Corporation. All SPARC trademarks are used under license and are trademarks or registered trademarks of SPARC International, Inc. AMD, Epyc, and the AMD logo are trademarks or registered trademarks of Advanced Micro Devices. UNIX is a registered trademark of The Open Group.

This software or hardware and documentation may provide access to or information about content, products, and services from third parties. Oracle Corporation and its affiliates are not responsible for and expressly disclaim all warranties of any kind with respect to third-party content, products, and services unless otherwise set forth in an applicable agreement between you and Oracle. Oracle Corporation and its affiliates will not be responsible for any loss, costs, or damages incurred due to your access to or use of third-party content, products, or services, except as set forth in an applicable agreement between you and Oracle.

Contents

1 Introduction

Overview	1-1
Acronyms and Terminology	1-2
References	1-3
Maintenance and Administration Subsystem	1-3
EAGLE Database Partitions	1-4

2 Global Title Translation (GTT) Overview

Introduction	2-1
Global Title Translation Feature	2-1
Enhanced Global Title Translation Feature	2-4
Variable-length Global Title Translation Feature	2-8
Advanced GT Modification Feature	2-10
Intermediate GTT Load Sharing Feature	2-12
ANSI/ITU SCCP Conversion Feature	2-12
Support of SCCP XUDT Messages	2-17
In-Sequence Delivery of Class 1 UDT Messages	2-18
Flexible GTT Load Sharing	2-19
Flexible Intermediate GTT Load Sharing	2-19
Flexible Final GTT Load Sharing	2-23
Origin-Based SCCP Routing	2-28
Hex Digit Support for GTT	2-35
Weighted GTT Load Sharing	2-38
Transaction-Based GTT Load Sharing	2-45
SCCP Loop Detection	2-50
Flexible Linkset Optional Based Routing	2-51
TCAP Opcode Based Routing	2-67
GTT Actions	2-74
Support for CAT2 SS7 Security	2-99
Executing CAT2 SS7 Security Functionality	2-102
MTP Routed Global Title Translation	2-103
Unique GTT Selectors	2-104

XUDT UDT Conversion Feature	2-108
Upgrading from Global Title Translation (GTT) to Enhanced Global Title Translation (EGTT)	2-112
SCCP Overview	2-115
GTT Configuration	2-128
EGTT Configuration	2-132
Adding a Service Module	2-135
Removing a Service Module	2-167
Adding a Mapped SS7 Message Translation Type	2-170
Removing a Mapped SS7 Message Translation Type	2-173
Changing a Mapped SS7 Message Translation Type	2-175
Adding a Concerned Signaling Point Code	2-178
Removing a Concerned Signaling Point Code	2-191
Provisioning a Solitary Mated Application	2-198
Provisioning a Dominant Mated Application	2-232
Provisioning a Load Shared Mated Application	2-282
Provisioning a Combined Dominant/Load Shared Mated Application	2-326
Removing a Mated Application	2-365
Changing the Attributes of a Mated Application	2-390
Changing the Mated Application Type	2-405
Changing the Weight and In-Service Threshold Values of a Mated Application	2-420
Changing the MRNSET and MRN Point Code Values of MAP Entries	2-443
Provisioning MRN Entries	2-451
Removing MRN Entries	2-489
Changing the Relative Cost Values of MRN Entries	2-508
Changing MRN Entries with the ESWT Parameter	2-518
Changing the Weight and Threshold Values of MRN Entries	2-532
Changing the MAPSET, MAP Point Code, and MAP SSN Values of MRN Entries	2-552
Adding a GT Conversion Table Entry	2-560
Removing a GT Conversion Table Entry	2-569
Changing a GT Conversion Table Entry	2-576
Changing the ANSI/ITU SCCP Conversion Options	2-589
Changing SCCP Class 1 Sequencing Option	2-593
Changing the SCCP Alarm Thresholds	2-597
Changing the Transaction-Based GTT Load Sharing Options	2-602
Adding a Loopset	2-606
Removing a Loopset	2-611
Changing the Attributes of a Loopset	2-619
Configuring the ANSI to ITU-N SCCP Conversion Option	2-632
Configuring a SCCP Test Message	2-634
Adding Global Title Modification Information	2-643

Removing Global Title Modification Information	2-651
Changing Global Title Modification Information	2-662
Changing the MTP-Routed GTT Options	2-673

3 Global Title Translation (GTT) Configuration

Introduction	3-1
Adding a Translation Type	3-2
Removing a Translation Type	3-20
Adding a Global Title Translation	3-31
Removing a Global Title Translation	3-72
Changing a Global Title Translation	3-82

4 Enhanced Global Title Translation (EGTT) Configuration

Introduction	4-1
Adding a GTT Set	4-2
Removing a GTT Set	4-12
Changing a GTT Set	4-22
Adding a GTT Selector	4-31
Removing a GTT Selector	4-53
Changing a GTT Selector	4-60
Adding Global Title Address Information	4-71
Removing Global Title Address Information	4-126
Changing Global Title Address Information	4-138
Changing the Default GTT Mode Options	4-197
Adding a GTT Action	4-204
Removing a GTT Action	4-230
Changing a GTT Action	4-239
Adding a GTT Action Set	4-264
Removing a GTT Action Set	4-269
Changing a GTT Action Set	4-273
Adding a GTT Action Path Entry	4-279
Removing a GTT Action Path Entry	4-289
Changing a GTT Action Path Entry	4-292
Changing the Unique GTT Selector Option	4-301

5 Controlled Feature Activation Procedures

Introduction	5-1
Activating the IGTTLS feature	5-2
Clearing a Temporary FAK Alarm	5-11

Turning Off the IGTTLS Feature	5-13
Enabling the XGTT Table Expansion Feature	5-17
Enabling the XMAP Table Expansion Feature	5-26
Activating the EPAP Data Split and Dual ExAP Configuration Features	5-35
Activating the EPAPX DB Expansion Feature	5-40
Activating the ANSI/ITU SCCP Conversion Feature	5-42
Activating the Flexible GTT Load Sharing Feature	5-52
Turning Off the Flexible GTT Load Sharing Feature	5-61
Activating the Origin-Based SCCP Routing Feature	5-64
Activating the Hex Digit Support for GTT Feature	5-76
Activating the Weighted GTT Load Sharing Feature	5-85
Activating the Transaction-Based GTT Load Sharing Feature	5-96
Activating the SCCP Loop Detection Feature	5-108
Activating the Throughput Capacity Feature	5-118
Activating the Advanced GT Modification Feature	5-128
Activating the GTT Load Sharing with Alternate Routing Indicator Feature	5-137
Turning Off the GTT Load Sharing with Alternate Routing Indicator Feature	5-148
Activating the Support for 16 GTT Lengths in VGTT Feature	5-150
Activating the Flexible Linkset Optional Based Routing Feature	5-161
Activating the TCAP Opcode Based Routing Feature	5-171
Enabling a TOBR Opcode Quantity	5-176
Activating the GTT Actions Features	5-180
Activating the XUDT UDT Conversion Feature	5-191

A MO SMS B-Party Routing Configuration Procedures

Introduction	A-1
Activating the MO SMS B-Party Routing Feature	A-2
Configuring the GSM MO SMS B-Party Routing Options	A-11
Configuring the IS-41 MO SMS B-Party Routing Options	A-15
Adding a Service Selector Entry for the MO SMS B-Party Routing Feature	A-20
Removing a Service Selector Entry	A-32
Changing the Attributes of a Service Selector Entry for the MO SMS B-Party Routing Feature	A-37
Turning the MO SMS B-Party Routing Feature Off	A-49

B MO SMS Prepaid Intercept on B-Party Configuration Procedures

Introduction	B-1
Activating the Prepaid SMS Intercept Phase 1 Feature	B-1
Configuring the B-Party Check Option for the Prepaid SMS Intercept Phase 1 Feature	B-9

Configuring Point Code Entries for the Prepaid SMS Intercept Phase 1 Feature	B-12
Configuring GTA Entries for the Prepaid SMS Intercept Phase 1 Feature	B-24
Turning Off the Prepaid SMS Intercept Phase 1 Feature	B-32

My Oracle Support (MOS)

My Oracle Support (<https://support.oracle.com>) is your initial point of contact for all product support and training needs. A representative at Customer Access Support can assist you with My Oracle Support registration.

Call the Customer Access Support main number at 1-800-223-1711 (toll-free in the US), or call the Oracle Support hotline for your local country from the list at <http://www.oracle.com/us/support/contact/index.html>. When calling, make the selections in the sequence shown below on the Support telephone menu:

- For Technical issues such as creating a new Service Request (SR), select **1**.
- For Non-technical issues such as registration or assistance with My Oracle Support, select **2**.
- For Hardware, Networking and Solaris Operating System Support, select **3**.

You are connected to a live agent who can assist you with My Oracle Support registration and opening a support ticket.

My Oracle Support is available 24 hours a day, 7 days a week, 365 days a year.

What's New in This Guide

Release 46.9.1 - March 2021

This section introduces the documentation updates for Release 46.9.1 in Oracle Communications EAGLE.

- Removed slan and stplan instances from the guide due to the discontinued support of the stplan application in EAGLE.
- Updated the [Table 2-35](#) table.

1

Introduction

Chapter 1, Introduction, contains an overview of the features described in this manual, considerations when upgrading from the Global Title Translation (GTT) feature to the Enhanced Global Title Translation (EGTT) feature, general information about the database, and the organization of this manual.

Overview

The *Database Administration – GTT User's Guide* describes the procedures used to configure the Oracle Communications EAGLE and its database to implement these features:

- Global Title Translation
- Enhanced Global Title Translation
- Variable-Length Global Title Translation
- Advanced GT Modification
- Intermediate GTT Load Sharing
- ANSI/ITU SCCP Conversion
- Flexible GTT Load Sharing
- Origin-Based SCCP Routing
- Hex Digit Support for GTT
- Weighted GTT Load Sharing
- Transaction-Based GTT Load Sharing
- SCCP Loop Detection
- MOSMSB-Party Routing
- MO SMS Prepaid Intercept on B-Party
- GTT Loadsharing between ITU Network Types
- GTT Loadsharing with Alternate Routing Indicator
- Support for 16 GTT Lengths in VGTT
- Flexible Linkset Optional Based Routing (FLOBR)
- TCAP Opcode Based Routing (TOBR)
- GTT Actions
- XUDT UDT Conversion

 **Note:**

Before enabling any of these features, make sure you have purchased the feature to be turned on. If you are not sure whether you have purchased the feature to be turned on, contact your Sales Representative or Account Representative.

 **Note:**

Database administration privileges are password restricted. Only those persons with access to the command class “Database Administration” can execute the administrative functions. Refer to *Commands User's Guide* for more information on command classes and commands allowed by those classes.

It is possible for two or more users to make changes to the same database element at any time during their database administration sessions. It is strongly recommended that only one user at a time make any changes to the database.

Throughout this manual, these terms are used to refer to either the original card or the EPM-B version or other replacement version of the card unless one of the card types is specifically required.

- E5-ENET - the original E5-ENET or the E5-ENET-B card
- E5-E1T1 - the original E5-E1T1 or the E5-E1T1-B card
- E5-ATM - the original E5-ATM or the E5-ATM-B card
- E5-IPSM - the original E5-IPSM or the E5-ENET-B card that is running the IPSHC GPL
- E5-SM4G - the original E5-SM4G or the E5-SM8G-B card (not an EPM-B card)
- MCPM - the original MCPM or the E5-MCPM-B card

Acronyms and Terminology

The following table provides information about the acronyms and the terminology used in the document.

Table 1-1 Acronyms and Terminology

Acronym	Definition
	Area Code
	Called Party Number
CgPN	Calling Party Number
DLM	Digits used for Delimiter
EPAP	EAGLE Application Processor Provisioning
GWS	Gateway Screening
NPP	Numbering Plan Processor
RTDB	Real Time Database

Table 1-1 (Cont.) Acronyms and Terminology

Acronym	Definition
TIF	Triggerless ISUP Framework

References

Refer the following documents for TIF feature related configurations:

- Numbering Plan Processor (NPP) User's Guide
- Database Administration - Features User's Guide
- Unsolicited Alarm and Information Messages Reference
- Administration Guide for EPAP

Maintenance and Administration Subsystem

The Maintenance and Administration Subsystem (MAS) is the central management point for the EAGLE. The MAS provides user interface, maintenance communication, peripheral services, alarm processing, system disk interface, and measurements. Management and redundancy are provided by use of two separate subsystem processors.

The MAS resides on two separate sets of Maintenance and Administration Subsystem Processor (MASP) cards and a Maintenance Disk and Alarm card (collectively referred to as control cards). The control cards are located in slots 1113 through 1118 of the EAGLE control shelf. The control cards must be E5-based cards.

E5-based Control Cards

The E5-based set of EAGLE control cards consists of the following cards:

- Two Maintenance and Administration Subsystem Processor cards (E5-MASP) cards. Each dual-slot E5-MASP card is made up of the following two modules:
 - Maintenance Communication Application Processor (E5-MCAP) card
 - Terminal Disk Module (E5-TDM) card
- One Maintenance Disk and Alarm card (E5-MDAL card)

Maintenance Communication Application Processor (E5-MCAP) Card

The E5-MCAP card contains the Communications Processor and Applications Processor and provides connections to the IMT bus. The card controls the maintenance and database administration activity and performs both application and communication processing. E5-MCAP cards are located in slots 1113 and 1115 of the control shelf.

Each E5-MCAP card contains two USB ports. One latched USB port is used with removable flash media ("thumb drives"), and one flush-mounted USB port is used with a plug-in flash drive. The removable media drive in the latched USB port is used to install and back up customer data. The flush-mounted USB port is used for upgrade and could be used for disaster recovery.

Terminal Disk Module (E5-TDM) Card

The E5-TDM card provides the Terminal Processor for the 16 I/O ports, and interfaces to the Maintenance Disk and Alarm (E5-MDAL) card and fixed disk storage. The E5-TDM card also distributes Composite Clocks and High Speed Source clocks throughout the EAGLE, and distributes Shelf ID to the EAGLE. Each E5-TDM card contains one fixed SATA drive that is used to store primary and backup system databases, measurements, and Generic Program Loads (GPLs). E5-TDM cards are located in slots 1114 and 1116 of the control shelf.

Maintenance Disk and Alarm (E5-MDAL) Card

The E5-MDAL card processes alarm requests and provides fan control. There is only one E5-MDAL card in a control card set. Critical, major, and minor system alarms are provided for up to 6 individual frames. In addition to the 3 system alarms, the E5-MDAL card provides the system audible alarm. The E5-MDAL card provides control of fans on a per-frame basis, and allows for each fan relay to be set individually. The E5-MDAL card is located in slots 1117 and 1118 of the control shelf.

EAGLE Database Partitions

The data that the EAGLE uses to perform its functions are stored in two separate areas: the fixed disk drives, and the removable media. The following sections describe these areas and data that is stored on them. These areas and their partitions are shown in [Figure 1-1](#).

Figure 1-1 EAGLE Database Partitions (E5-Based Control Cards)

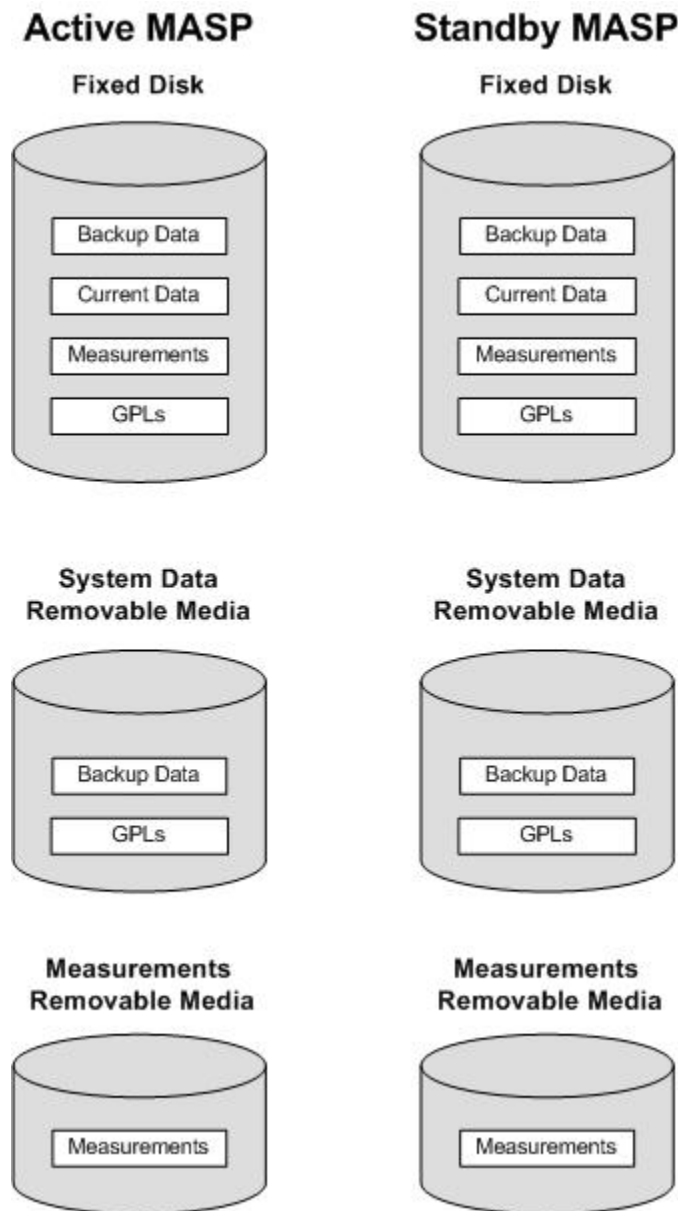

Fixed Disk Drive

There are two fixed disk drives on the EAGLE. The fixed disk drives contain the “primary” set of data and programs for the EAGLE. The two fixed disk drives are located on the terminal disk modules (E5-TDMs). Both disks have the same files. The data stored on the fixed disks is partially replicated on the various cards in the EAGLE. Changes made during database administration sessions are sent to the appropriate cards.

The data on the fixed disks can be viewed as four partitions.

- Current partition
- Backup partition

- Measurements partition
- Generic program loads (GPLs) partition

The data which can be administered by users is stored in two partitions on the fixed disk, a current database partition which has the tables which are changed by on-line administration, and a backup database partition which is a user-controlled copy of the current partition.

All of the on-line data administration commands affect the data in the current partition. The purpose of the backup partition is to provide the users with a means of rapidly restoring the database to a known good state if there has been a problem while changing the current partition.

A full set of GPLs is stored on the fixed disk, in the GPL partition. There is an approved GPL and a trial GPL for each type of GPL in this set and a utility GPL, which has only an approved version. Copies of these GPLs are downloaded to the EAGLE cards. The GPL provides each card with its functionality. For example, the `ss7ansi` GPL provides MTP functionality for link interface modules (LIMs).

Measurement tables are organized as a single partition on the fixed disk. These tables are used as holding areas for the measurement counts.

Removable Media

The removable media is used with the E5-MCAP card portion of the E5-MASP in card locations 1113 and 1115.

The removable media is used for two purposes.

- To hold an off-line backup copy of the administered data and system GPLs
- To hold a copy of the measurement tables

Because of the size of the data stored on the fixed disk drives on the E5-TDMs, a single removable media cannot store all of the data in the database, GPL and measurements partitions.

To use a removable media to hold the system data, it must be formatted for system data. To use a removable media to hold measurements data, it must be formatted for measurements data. The EAGLE provides the user the ability to format a removable media for either of these purposes. A removable media can be formatted on the EAGLE by using the `format-disk` command. More information on the `format-disk` command can be found in *Commands User's Guide*. More information on the removable media drives can be found in *Hardware Guide*.

Additional and preformatted removable media are available from the [#unique_17](#).

2

Global Title Translation (GTT) Overview

Chapter 2, Global Title Translation (GTT) Overview, describes the Global Title Translation feature and the procedures common to both the Global Title Translation (GTT) and Enhanced Global Title Translation (EGTT) features. This chapter also describes the features shown in the [Overview](#) section.

Introduction

This chapter describes the Global Title Translation (GTT) and the Enhanced Global Title Translation (EGTT) features and these optional add-on features.

- Variable-length Global Title Translation
- Advanced GT Modification
- Intermediate GTT Load Sharing
- ANSI/ITU SCCP Conversion
- Flexible GTT Load Sharing
- Origin-Based SCCP Routing
- Hex Digit Support for GTT
- Weighted GTT Load Sharing
- Transaction-Based GTT Load Sharing
- SCCP Loop Detection
- Flexible Linkset Optional Based Routing
- TCAP Opcode Based Routing
- GTT Actions
- XUDT UDT Conversion

This chapter also contains the procedures that are common to configuring either the Global Title Translation (GTT) feature or the Enhanced Global Title Translation (EGTT) feature. To find out about the differences between Global Title Translation feature and the Enhanced Global Title Translation feature, refer to the [Upgrading from Global Title Translation \(GTT\) to Enhanced Global Title Translation \(EGTT\)](#) section.

Global Title Translation Feature

The Global Title Translation (GTT) feature is designed for the signaling connection control part (SCCP) of the SS7 protocol. The EAGLE uses this feature to determine to which service database to send the query message when a Message Signaling Unit (MSU) enters the EAGLE and more information is needed to route the MSU.

If an MSU enters the EAGLE and more information is needed to route the MSU, the SCCP of the SS7 protocol sends a query to a service database to obtain the information. The EAGLE uses the GTT feature for the SCCP to determine which

service database to send the query messages to. These service databases are also used to verify calling card numbers and credit card numbers. The service databases are identified in the SS7 network by a point code and a subsystem number.

The GTT feature uses global title address (GTA) information to determine the destination of the MSU. The translation type (TT) indicates which global title translation table is used to determine the routing to a particular service database. Each global title translation table includes the point code (pc) of the node containing the service database, the subsystem number (ssn) identifying the service database on that node, and a routing indicator (ri). The routing indicator determines if further global title translations are required. GTA and TT are contained in the called party address (CDPA) field of the MSU.

The global title translation feature changes the destination point code and the origination point code in the routing label. The global title information is not altered. The routing label is changed to indicate the new destination point code retrieved from the global title translation and the origination point code is set to the EAGLE's point code.

Depending on how the global title translation data is configured, the routing indicator, the subsystem number, or the translation type in the called party address may also be changed by the global title translation feature. The gray shaded areas in [Figure 2-1](#) show the message fields affected by global title translation.

Figure 2-1 ANSI and ITU MSU Fields affected by the Global Title Translation Feature

ANSI MSU (ANSI Message Signal Unit)

BSN FSN LI	SIO xx xx xxxx NIC PRI SI	SIF			
		Routing Label DPC OPC SLS NCM NC NI NCM NC NI xx		CGPA Length Address Indicator (x x xxxx x x) Subsystem Point Code (NCM NC NI)	CDPA Length Address Indicator (x RI xxxx xx) Subsystem Point Code (NCM NC NI) Address (Translation Type) (Digits)

ITU-I MSU (ITU International Message Signal Unit)

BSN FSN LI	SIO xx xx xxxx NIC PRI SI	SIF			
		Routing Label DPC OPC SLS ID AREA ZONE ID AREA ZONE xx		CGPA Length Address Indicator (x x xxxx x x) Subsystem Point Code (ID AREA ZONE)	CDPA Length Address Indicator (x RI xxxx xx) Subsystem Point Code (ID AREA ZONE) Address (Translation Type) (Digits)

14-Bit ITU-N MSU (14-Bit ITU National Message Signal Unit)

BSN FSN LI	SIO xx xx xxxx NIC PRI SI	SIF			
		Routing Label DPC OPC SLS NPC NPC xx		CGPA Length Address Indicator (x x xxxx x x) Subsystem Point Code (NPC)	CDPA Length Address Indicator (x RI xxxx xx) Subsystem Point Code (NPC) Address (Translation Type) (Digits)

24-Bit ITU-N MSU (24-Bit ITU National Message Signal Unit)

BSN FSN LI	SIO xx xx xxxx NIC PRI SI	SIF			
		Routing Label DPC OPC SLS MSA SSA SP MSA SSA SP xx		CGPA Length Address Indicator (x x xxxx x x) Subsystem Point Code (SP SSA MSA)	CDPA Length Address Indicator (x RI xxxx xx) Subsystem Point Code (SP SSA MSA) Address (Translation Type) (Digits)

The GTT feature allows global title translation on global title addresses of fixed length. There are three optional add-on features that enhance the functionality of the global title translation feature:

- The Variable-length Global Title Translation feature (VGTT) feature allows global title translation on global title addresses of varying length. For more information on this feature, refer to the [Variable-length Global Title Translation Feature](#) section.

- The Advanced GT Modification feature allows the EAGLE to modify other fields of an MSU in addition to the translation type when the MSU requires further global title translation and the translation type is to be replaced. For more information about this feature, refer to the [Advanced GT Modification Feature](#) section.
- The ANSI/ITU SCCP Conversion Feature converts SCCP messages between the ANSI and ITU formats. For more information about this feature, refer to the [ANSI/ITU SCCP Conversion Feature](#) section.

The EAGLE supports:

- 269,999, 400,000, or 1,000,000 global title translations. The system default is 269,999 global title translations. This quantity can be increased to 400,000 by enabling the feature access key for part number 893-0061-01, or to 1,000,000 by enabling the feature access key for part number 893-0061-10. For more information on enabling these feature access keys, refer to the [Enabling the XGTT Table Expansion Feature](#) procedure.
- A maximum of 200,000 global title translations assigned to a translation type.
- 512 translation types, 256 translation types for ANSI MSUs, and 256 translation types for ITU MSUs.
- 1024, 2000, or 3000 remote point codes (mated applications), with up to 10 subsystems at each point code. The system default is 1024 mated applications. This quantity can be increased to 2000 by enabling the feature access key for part number 893-0077-01, or to 3000 by enabling the feature access key for part number 893-0077-10. For more information on enabling these feature access keys, refer to the [Enabling the XMAP Table Expansion Feature](#) procedure.

The GTT feature requires one of the following cards:

- Database Services Module (DSM) (Refers to the E5-SM4G or E5-SM8G-B card)
- SLIC card

For more information on these cards, refer to the [Adding a Service Module](#) procedure or to *Hardware Reference*.

Enhanced Global Title Translation Feature

The Enhanced Global Title Translation (EGTT) feature is designed for the signaling connection control part (SCCP) of the SS7 protocol. The EAGLE uses this feature to determine to which service database to send the query message when a Message Signaling Unit (MSU) enters the EAGLE and more information is needed to route the MSU.

If an MSU enters the EAGLE and more information is needed to route the MSU, the SCCP of the SS7 protocol sends a query to a service database to obtain the information. The EAGLE uses the EGTT feature for the SCCP to determine which service database to send the query messages to. The service databases are identified in the SS7 network by a point code and a subsystem number.

The EGTT feature uses global title information (GTI) to determine the destination of the MSU. The EAGLE supports ANSI GTI format 2 and ITU GTI formats 2 and 4. The GTI is contained in the called party address (CDPA) field of the MSU. For ITU GTI format 4, the GTI is made up of the Numbering Plan (NP), Nature of Address Indicator (NAI), and Translation Type (TT) selectors.

The EGTT feature allows global title translation on global title addresses of fixed length. There are three optional add-on features that enhance the functionality of the enhanced global title translation feature:

- The Variable-length Global Title Translation feature (VGTT), allows global title translation on global title addresses of varying length. For more information on this feature, refer to the [Variable-length Global Title Translation Feature](#) section.
- The Advanced GT Modification feature allows the EAGLE to modify other fields of an MSU in addition to the translation type when the MSU requires further global title translation and the translation type is to be replaced. For more information about this feature, refer to the section [Advanced GT Modification Feature](#).
- The ANSI/ITU SCCP Conversion Feature converts SCCP messages between the ANSI and ITU formats. For more information about this feature, refer to the [ANSI/ITU SCCP Conversion Feature](#) section.

The EGTT feature requires one of the following cards:

- EAGLE 5-Service Module 8GB (E5-SM8G-B) or SLIC

For more information on these cards, refer to the [Adding a Service Module](#) procedure or to *Hardware Reference*.

Inclusion of SSN in the CDPA

When the obtained translation data contains a subsystem, the translated SSN is placed in the SCCP CDPA before the message is sent to the next node. However, when no SSN is present in the CDPA, this insertion applies to ITU messages only. ANSI messages that do not contain an SSN in the CDPA will be rejected. The gray shaded areas in [Figure 2-2](#) show the message fields affected by enhanced global title translation.

Figure 2-2 ANSI and ITU MSU Fields affected by the Enhanced Global Title Translation Feature

ANSI MSU (ANSI Message Signal Unit)

BSN FSN LI	SIO xx xx xxxx NIC PRI SI	SIF		
		Routing Label DPC OPC SLS NCM NC NI NCM NC NI xx	CGPA Length Address Indicator (x x xxxx x x) Subsystem Point Code (NCM NC NI)	CDPA Length Address Indicator (x RI xxxx xx) Subsystem Point Code (NCM NC NI) Address (Translation Type) (Digits)

ITU-I MSU (ITU International Message Signal Unit)

BSN FSN LI	SIO xx xx xxxx NIC PRI SI	SIF		
		Routing Label DPC OPC SLS ID AREA ZONE ID AREA ZONE xx	CGPA Length Address Indicator (x x xxxx x x) Subsystem Point Code (ID AREA ZONE)	CDPA Length Address Indicator (x RI xxxx xx) Subsystem Point Code (ID AREA ZONE) Address (TT NAI NP Digits)

14-Bit ITU-N MSU (14-Bit ITU National Message Signal Unit)

BSN FSN LI	SIO xx xx xxxx NIC PRI SI	SIF		
		Routing Label DPC OPC SLS NPC NPC xx	CGPA Length Address Indicator (x x xxxx x x) Subsystem Point Code (NPC)	CDPA Length Address Indicator (x RI xxxx xx) Subsystem Point Code (NPC) Address (TT NAI NP Digits)

24-Bit ITU-N MSU (24-Bit ITU National Message Signal Unit)

BSN FSN LI	SIO xx xx xxxx NIC PRI SI	SIF		
		Routing Label DPC OPC SLS MSA SSA SP MSA SSA SP xx	CGPA Length Address Indicator (x x xxxx x x) Subsystem Point Code (SP SSA MSA)	CDPA Length Address Indicator (x RI xxxx xx) Subsystem Point Code (SP SSA MSA) Address (TT NAI NP Digits)

Inclusion of OPC in the CGPA

When an ITU unitdata (UDT) message does not have a point code (PC) present in the CGPA, and the CGPA route indicator (RI) is set to **Route on SSN**, the EGTT feature will insert the OPC from the Message Transfer Part (MTP) routing label into the CGPA before sending the message to the next node. The insertion does not apply to ANSI GTT processing.

Deletion of GT

The EGTT feature allows a Global Title (GT) in the CDPA to be deleted. For example, when the result of a GTT performed by the EAGLE is set to “Route on SSN”, there may be some end nodes that do not want to receive the GT information in the CDPA. The enhancement provides an option on a per translation basis (for both ANSI and ITU) to allow the GT to be deleted (`ent-gta:gta=000:ri=ssn:ccgt=yes` command). The option is not valid when the result of the GT is the EAGLE's point code and local SSN.

New Commands

The EGTT feature introduces three new command sets:

- GTTSET commands
 - ENT-GTTSET – Enter GTT Set
 - CHG-GTTSET – Change GTT Set
 - DLT-GTTSET – Delete GTT Set
 - RTRV-GTTSET – Retrieve GTT Set
- GTTSEL commands
 - ENT-GTTSEL – Enter GTT Selector
 - CHG-GTTSEL – Change GTT Selector
 - DLT-GTTSEL – Delete GTT Selector
 - RTRV-GTTSEL – Retrieve GTT Selector
- GTA commands
 - ENT-GTA – Enter Global Title Address
 - CHG-GTA – Change Global Title Address
 - DLT-GTA – Delete Global Title Address
 - RTRV-GTA – Retrieve Global Title Address

GTT Set Commands

The GTT Set commands are used to provision new sets of GTTs, linking GTT Selector (-GTTSEL) and Global Title Address (-GTA) commands. This set of commands provides greater flexibility when provisioning the type of messages that require Global Title Translation. There are no SEAS equivalents for these commands.

GTT Selector Commands

The GTT Selector commands are used to provision new selectors for global title translation. Together with the GTT Set commands, these commands replace the Translation Type (-TT) commands, providing greater flexibility when provisioning the type of messages that require Global Title Translation. There are no SEAS equivalents for these commands.

GTA Commands

GTA commands are used to provision GTTs using the new selectors for GTT.

The EAGLE supports the following:

- Maximum of 950 GTT sets.
- Maximum of 200,000 global title addresses per GTT set.
- 269,999, 400,000, or 1,000,000 global title addresses. The system default is 269,999 global title addresses. This quantity can be increased to 400,000 by enabling the feature access key for part number 893-0061-01, or to 1,000,000 by enabling the feature access key for part number 893-0061-10. For more information on enabling these feature access keys, refer to the [Enabling the XGTT Table Expansion Feature](#) procedure.
- Maximum of 100,000 GTT selectors.
- 1024, 2000, or 3000 remote point codes (mated applications), with up to 10 subsystems at each point code. The system default is 1024 mated applications. This quantity can be increased to 2000 by enabling the feature access key for part number 893-0077-01, or to 3000 by enabling the feature access key for part number 893-0077-10. For more information on enabling these feature access keys, refer to the [Enabling the XMAP Table Expansion Feature](#) procedure.

Variable-length Global Title Translation Feature

A translation type or GTT set can contain global title addresses of varying length. If the Variable-length Global Title Translation (VGTT) feature is turned on with the `chg-feat` command, a translation type or GTT set contain up to 10 different length global title addresses. If the Support for 16 GTT Lengths in VGTT feature is enabled and turned on with the `enable-ctrl-feat` and `chg-ctrl-feat` commands, a translation type or GTT set can contain up to 16 different length global title addresses. The Support for 16 GTT Lengths in VGTT feature cannot be enabled and turned on unless the VGTT feature is turned on.

The length of the global title address is only limited by the range of values for the `gta` and `egta` parameters of either the `ent-gtt` and `chg-gtt` commands, if only the GTT feature is turned on, or the `ent-gta` and `chg-gta` commands, if the EGTT feature is turned on, and by the global title addresses already assigned to the translation type or GTT set. The length of a global title address is from 1 to 21 digits, or 1 to 21 hexadecimal digits if the Hex Digit Support for GTT feature is enabled. The `ndgt` parameter of the `ent-tt` or `ent-gttset` command has no effect on the length of the global title address and cannot be used. If the `ndgt` parameter is specified with the `ent-tt` or `ent-gttset` command and the VGTT feature is on or the Support for 16 GTT Lengths in VGTT feature is enabled and turned on, the `ent-tt` or `ent-gttset` command is rejected with this message.

```
E4011 Cmd Rej: NDGT parameter is invalid for VGTT
```

As global title addresses of different lengths are assigned to a specific translation type, these lengths are displayed in the NDGT field of the `rtrv-tt` command output, as shown in the following example.

```
rlghncxa03w 09-05-25 09:57:31 GMT EAGLE5 41.0.0
TYPEA      TTN      NDGT
1          lidb      6, 12, 15
2          c800      10
3          d700      6
```

ALIAS	TYPEA	
50	3	
65	3	
TYPEI	TTN	NDGT
105	itudb	8
ALIAS	TYPEI	
7	105	
TYPEN	TTN	NDGT
120	dbitu	7
ALIAS	TYPEN	
8	120	

If the global title addresses are assigned to a GTT set, these lengths are displayed in the NDGT field of the `rtrv-gttset` command output, as shown in the following example.

```
rlghncxa03w 09-07-07 00:30:31 GMT EAGLE5 41.1.0
GTTSN      NETDOM  NDGT
lidb       ansi    3, 7, 10
t800       ansi    6
si000      itu     15
imsi       itu     15
abcd1234   itu     12
```

GTT-SET table is (5 of 2000) 1% full.

In the `rtrv-tt` output example, the ANSI translation type 1 contains three different length global title addresses; global title addresses containing 6 digits, 12 digits, and 15 digits.

In the `rtrv-gttset` example, the GTT set `lidb` contains three different length global title addresses; global title addresses containing 3 digits, 7 digits, and 10 digits.

When the VGTT feature is on, and the last global title address of a particular length is deleted for the specified translation type or GTT set, then that length is no longer supported. That length is not displayed in the NDGT field of the `rtrv-tt` or the `rtrv-gttset` output. For example, if the last 6-digit global title address is deleted from ANSI translation type 1 (from the previous example), the NDGT field of the `rtrv-tt` command shows only the numbers 12 and 15 in the NDGT field indicating that ANSI translation type 1 contains only 12- and 15-digit global title addresses. If the last 7-digit global title address is deleted from GTT set `lidb` (from the previous example), the NDGT field of the `rtrv-gttset` command shows only the numbers three and 10 in the NDGT field indicating that GTT set `lidb` contains only 3- and 10-digit global title addresses.

If the translation type has the maximum number of different length global title addresses assigned to it, and another global title address is specified for the translation type, the length of the global title address being added to the translation type must be the same as one of the lengths already assigned to the translation type.

If the length of the global title address is not one of the lengths shown in the `rtrv-tt` output, the `ent-gtt` command is rejected with this message.

```
E4007 Cmd Rej: Exceeding max GTA Lengths supported per TT
```

If the GTT set has the maximum number of different length global title addresses assigned to it, and another global title address is specified for the GTT set, the length of the global title address being added to the GTT set must be the same as one of the lengths already assigned to the GTT set. If the length of the global title address is not one of the lengths shown in the `rtrv-gttset` output, the `ent-gta` command is rejected with this message.

```
E4008 Cmd Rej: Exceeding max GTA Lengths supported per GTTSET
```

If the translation type or GTT set has less than the maximum number of different length global title addresses assigned to it, and another global title address is specified for the translation type or GTT set, the length of the global title address can be from one to 21 digits and does not have to match the length of the other global title addresses assigned to the translation type or the GTT set.

If the VGTT feature is off, shown the entry `VGTT = off` in the `rtrv-feat` output, the global title address length must be equal to the number of digits specified by the given translation type or GTT set. The length of the global title address can be verified with the `rtrv-tt` or `rtrv-gttset` command.

The VGTT and the Support for 16 GTT Lengths in VGTT features require that a service module is installed in the EAGLE. [Adding a Service Module](#) shows the type of service modules that can be used depending on which features are on or enabled.

Advanced GT Modification Feature

This feature allows the EAGLE to modify other fields of an MSU in addition to the translation type, destination point code, called party point code, called party SSN, routing indicator, numbering plan, and nature of address indicator when the MSU requires further global title translation and the translation type is to be replaced.

The numbering plan, nature of address indicator, and the prefix or suffix digits, in the called party address or calling party address portion of outbound MSUs can be changed with this feature to make the MSU more compatible with the network that the MSU is being sent to and to ensure that the MSU is routed correctly. These changes are made after the global title translation process, but before the MSU is routed to its destination.

This feature requires that service modules are installed in the EAGLE. [Adding a Service Module](#) shows the type of service modules that can be used depending on which features are on or enabled.

For the EAGLE to be able to make these changes to the called party address or calling party address portion of the MSU, the one of the Advanced GT Modification features shown in the following list must be enabled with the `enable-ctrl-feat` command.

- 893021801 - AMGTT - provides GT modification to both the called party address and the calling party address of SCCP messages. This part number can be specified only if no Advanced GT Modification feature is currently enabled.
- 893021802 - AMGTT CdPA Only - provides GT modification to the called party address of SCCP messages only. This feature and its part number is shown in the `rtrv-ctrl-feat` output only if the MGTT feature from previous releases was

turned on when the Eagle was upgraded to the release containing the Advanced GT Modification feature. This part number cannot be specified with the `enable-ctrl-feat` command.

- 893021803 - AMGTT CgPA Upgrade - provides GT modification to the calling party address and called party address of SCCP messages. This part number can be specified only if the AMGTT CdPA Only feature (part number 893021802) is enabled.

Perform the [Activating the Advanced GT Modification Feature](#) procedure to enable the Advanced GT Modification feature.

After the Advanced GT Modification feature has been enabled, the parameters shown in this list are used to modify the calling party address or called party address of the SCCP message.

- `gtmodid` – The name of the GT modification identifier
- `ntt` – The new translation type. None of the Advanced GT Modification features have to be enabled to create an entry in the GT modification table that contains only the `ntt` parameter value.
- `npn` – The new numbering plan
- `nnai` – The new nature of address indicator
- `npdd` – The number of digits to be deleted from the beginning of the Global Title Address digits (the prefix digits)
- `npds` – The digits that are being substituted for the prefix digits
- `nsdd` – The number of digits to be deleted from the end of the Global Title Address digits (the suffix digits)
- `nsds` – The digits that are being substituted for the suffix digits
- `cgpasn` – The calling party subsystem number
- `gt0fill` – Specifies whether the final 0 of the global title address is considered a valid digit in the global title address or as a filler during the GT modification process when going from GTI=2 to GTI=4. If the final 0 is considered as a filler, then it is ignored during the GT modification process. This parameter has two values, `on` or `off`. If the `gt0fill` value is `on`, the final 0 in the global title address is a filler. If the `gt0fill` value is `off`, the final 0 in the global title address is a valid digit.
- `ngti` – The new global title indicator value
- `precd` – Specifies whether the prefix or suffix digits take precedence when modifying the received global title address. This parameter can be specified only when the `npdd/npds` and the `nsdd/nsds` parameters are specified. This parameter has two values, `px` and `sfx`. When the `precd` value is `px`, the prefix digits (`npdd/npds` values) are processed before the suffix digits (`nsdd/nsds` values). When the `precd` value is `sfx`, the suffix digits (`nsdd/nsds` values) are processed before the prefix digits (`npdd/npds` values)
- `cggmod` - The calling party GT modification indicator. This parameter specifies whether or not calling party global title modification is required. This parameter can be specified only if the AMGTT or AMGTT CgPA Upgrade feature is enabled. The `cggmod` parameter can also be specified for when provisioning a linkset to indicate that calling party global title modification is required for SCCP traffic on

the linkset. This parameter is configured with the `ent-gtt`, `chg-gtt`, `ent-gta`, or `chg-gta` commands.

All the parameters, except the `cggtmod` parameter, are configured as an entry in the in the GT modification table using either the `ent-gtmod` or `chg-gtmod` commands. Each entry in the GT modification table is identified by the `gtmodid` parameter. The EAGLE can contain 100,000 GT modification identifier entries. Each entry is referenced in the GTT, GTA, and GTT actions tables. Perform one of these procedures to configure these parameters.

- [Adding Global Title Modification Information](#)
- [Changing Global Title Modification Information](#)

To configure the `cggtmod` parameter, perform one of these procedures.

- [Adding a Global Title Translation](#)
- [Changing a Global Title Translation](#)
- [Adding Global Title Address Information](#)
- [Changing Global Title Address Information](#)

Intermediate GTT Load Sharing Feature

This feature allows GTT traffic between multiple nodes to be load shared when intermediate global title translation (routing indicator in the message is GT) is being performed. A mated relay node (MRN) group is provisioned in the database to identify the nodes that the traffic is load shared with, and the type of routing, either dominant, load sharing, or combined dominant/load sharing. This load sharing is performed after intermediate global title translation is performed on the message. For more information, refer to [Provisioning MRN Entries](#).

ANSI/ITU SCCP Conversion Feature

Since some ANSI and ITU SCCP parameters are incompatible in format or coding, this feature provides a method for the EAGLE to convert these SCCP parameters in UDT, UDTS, XUDT, and XUDTS messages. Other types of SCCP messages (for example, XUDTS) are not supported and are discarded.

A specialized SCCP/TCAP conversion, introduced in EAGLE release 22.2 and used only in the Korean market, does not support this feature. The ANSI/ITU SCCP Conversion feature cannot be used with the EAGLE release 22.2 SCCP and TCAP Conversion features.

The ANSI/ITU SCCP Conversion feature provides a generic capability to correctly format and decode/encode these SCCP messages:

- UDT, UDTS, XUDT, and XUDTS messages. UDT and UDTS messages include SCMG messages, which are a specialized form of UDT messages.
- MTP routed SCCP messages.
- GT routed SCCP messages.

This feature also provides SCCP management (SCMG) across network type boundaries. For example, concerned signaling point codes for a mated application

may be of a different network type than the primary point code of the mated application.

The ANSI/ITU SCCP Conversion is optional for ITU-X to ITU-Y domain crossing, where X and Y are different variants of ITU domains (ITU-I, ITU-N, ITU-I Spare and ITU-N Spare).

Advanced GT Modification

The Advanced GT Modification feature allows the deletion or substitution of digits from the beginning (prefix digit modification) or the end (suffix digit modification) of the global title address in either the called party address or the calling party address of the MSU. Prefix and suffix digit modifications are performed based on the prefix and suffix digit modification parameter values that are contained in the GT modification identifier that is assigned to the GTT, GTA, or GTT Actions entry. If the Advanced GT Modification feature is enabled, each GTT, GTA, or GTT Actions entry can specify either prefix digit modification, suffix digit modification, or both prefix and suffix digit modification. Refer to the [Advanced GT Modification Feature](#) section for more information on the Advanced GT Modification feature.

ANSI/ITU SCCP Conversion Feature Configuration

This feature requires that service modules are present in the EAGLE. [Adding a Service Module](#) shows the type of service modules that can be used depending on which features are on or enabled.

The parameter CNVCLGITU in SCCPOPTS makes the SCCP CGPA conversion optional for ITU-I to ITU-N domain crossing. The default value of this parameter is OFF when ANSI/ITU SCCP Conversion feature is turned on. If the feature is already ON, and the system is upgraded to Eagle 45.0, the default value is ON.

With the introduction of the parameter `cgpcaction` under the `ent/chg-gta` commands, CGPCACTION in GTA is applied regardless of whether the domain crossing was determined by GTT or not. Refer to *Commands User's Guide* for more details and options.

ITU-I to ITU-N SCCP CgPA conversion is optional for GTT related features only (GTT, GTT Actions, GTMOD and MAP SCRN). It is not applicable for services and subsystems that perform GTT on CgPA (GPORT, EIR, IDPR)

The ANSI/ITU SCCP Conversion feature must be enabled with the `enable-ctrl-feat` command, and turned on with the `chg-ctrl-feat` command. Perform the [Activating the ANSI/ITU SCCP Conversion Feature](#) procedure to enable and turn on the ANSI/ITU SCCP Conversion feature.

The concerned signaling point code (CSPC) group configuration has been changed to allow CSPC groups to contain ANSI (`pc/pca`), ITU-I or ITU-I spare (`pci`), and either 14-bit ITU-N or 14-bit ITU-N spare (`pcn`), or 24-bit ITU-N (`pcn24`) point codes. A CSPC group cannot contain both 14-bit and 24-bit ITU-N point codes. Concerned signaling point code groups are configured in the [Adding a Concerned Signaling Point Code](#) procedure.

The format of the point codes in the CSPC group assigned to a mated application, specified with the `grp` parameter, must be the same as the primary point code specified with the `ent-map` or `chg-map` commands only if the ANSI/ITU SCCP Conversion feature is not enabled. If the ANSI/ITU SCCP Conversion feature is enabled, the CSPC group may contain a mixture of point code types, and the network

type of the CSPC group can be different from the network type of the primary point code of the mated application. Mated applications are configured in these procedures.

- [Provisioning a Solitary Mated Application](#)
- [Provisioning a Dominant Mated Application](#)
- [Provisioning a Load Shared Mated Application](#)
- [Provisioning a Combined Dominant/Load Shared Mated Application](#)
- [Changing the Attributes of a Mated Application.](#)

The conversion of ANSI and ITU SCCP messages is performed according to the options in the STP Options table, and by the entries contained in the default GT conversion table.

These options in the STP Options table control how this feature works.

:cnvcgda – The CGPA point code in ANSI SCCP messages are discarded if the point code or alias point code of the destination network type is not defined.

:cnvcgdi – The CGPA point code in ITU-I SCCP messages are discarded if the point code or alias point code of the destination network type is not defined.

:cnvcgdn – The CGPA point code in ITU-N SCCP messages are discarded if the point code or alias point code of the destination network type is not defined.

:cnvcgdn24 – The CGPA point code in ITU-N24 SCCP messages are discarded if the point code or alias point code of the destination network type is not defined.

:cnvclgitu – Allows for ITU-X to ITU-Y SCCP CGPA Conversion.

:gtcnvdf1t – SCCP messages are routed using system defaults when an appropriate entry is not found in the Default GT Conversion Table.

The values for these options are either *yes* or *no*. If these options are set to *yes*, the actions defined by these options will be performed. These options are configured using the `chg-stpopts` command in the [Changing the ANSI/ITU SCCP Conversion Options](#) procedure.

 **Note:**

If the value of the `cnvcgda`, `cnvcgdi`, or `cnvcgdn` options is *no*, and the calling party address of the MSU cannot be converted when the MSU is processed, then the MSU is discarded.

The Default GT Conversion Table contains the following items:

- The direction that the conversion takes place: ANSI to ITU, ITU to ANSI, or both directions.
- The global title indicator types being converted.
 - ANSI GTI type 2 to ITU GTI type 2
 - ANSI GTI type 2 to ITU GTI type 4
- The ANSI translation type
- The ITU translation type

- The numbering plan
- The nature of address indicator

The Default GT Conversion Table also provides for the provisioning of prefix or suffix address digit modification (refer to the [Advanced GT Modification](#) section. The Default GT Conversion Table is configured using either the `ent-gtcnv` command to add new entries to the Default GT Conversion Table (refer to the [Adding a GT Conversion Table Entry](#) procedure), or the `chg-gtcnv` command to change existing entries in the Default GT Conversion Table (refer to the [Changing a GT Conversion Table Entry](#) procedure).

The called party/calling party address indicator bit that is used when performing ANSI to ITU-N SCCP conversion is configured with the `chg-sccpopts` command. Perform the [Configuring the ANSI to ITU-N SCCP Conversion Option](#) procedure to select which called party/calling party address indicator bit will be used.

 **Note:**

The called party/calling party address indicator bit in the MSU may be modified as soon as the ANSI/ITU SCCP Conversion is enabled and turned on, depending on the destination network of the MSU. If the MSU is sent to an ITU-I network, the value of the called party/calling party address indicator bit in the MSU may be changed to 0. If the MSU is sent to an ANSI or ITU-N network, the value of the called party/calling party address indicator bit in the MSU may be changed to 1. If you wish to set the value of the called party/calling party address indicator bit in the MSU after the ANSI/ITU SCCP Conversion is enabled and turned on, perform the [Configuring the ANSI to ITU-N SCCP Conversion Option](#) procedure.

 **Note:**

The national indicator bit /international indicator bit for ANSI network or the ITU Reserved for National Use field (bit 8) within the calling party address/called party address indicator in the MSU may be modified as soon as the ANSI/ITU SCCP Conversion is enabled and turned on, depending on the destination network of the MSU. When an ANSI message is converted to an ITU message, the ITU Reserved for National Use field (bit 8) is set to the network associated with the post conversion DPC for MTP routed messages and the translated DPC for GT routed messages.

- If the DPC of the message is an ITU-N point code, then the ITU Reserved for National Use field is set to 1.
- If the DPC of the message is an ITU-I point code, then the ITU Reserved for National Use field is set to 0.

When an ITU message is converted to an ANSI message, the ANSI National/International Indicator (bit 8) is set to 1 (National).

If you wish to set the value of the Reserved for National Use bit (bit 8) in the calling party address/called party address indicator in the MSU after the ANSI/ITU SCCP Conversion is enabled and turned on, perform the [Configuring the ANSI to ITU-N SCCP Conversion Option](#) procedure.

Without the ANSI/ITU SCCP Conversion feature enabled, the domain of a GTT set must be the same as the domain of the GTI value of the GTT selectors. For example, an ANSI GTT set can be assigned to only ANSI GTT selectors and an ITU GTT set can be assigned to only ITU GTT selectors. When the ANSI/ITU SCCP Conversion feature is enabled a GTT set to be assigned to GTT selectors in both domains. This accomplished by creating a GTT set with the network domain of CROSS, a cross-domain GTT set. This allows the provisioning a single cross-domain GTT set with one set of GTA data and assign the cross-domain GTT set to multiple GTT selectors, regardless of their domain. The result is a GTT set that contains GTA data that can be used to translate both ANSI and ITU messages. Provisioning of the cross-domain GTT set is performed with the `ent-gttset` command. The EAGLE can contain more than one cross-domain GTT set. If the domain of the GTT set is either ANSI or ITU, the domain of a GTT set must be the same as the domain of the GTT selector. The domain of the GTT set can be changed from an ANSI GTT set or ITU GTT set to a cross-domain GTT set using the `chg-gttset` command. The EGTT feature must be turned on and the ANSI/ITU SCCP Conversion feature must be enabled to provision a cross-domain GTT set.

Alias Point Codes

For MTP routed SCCP messages, the message's DPC, OPC and CDPA must have alias point codes. The message's DPC, which is an alias, is converted to its true point code. The OPC is converted to its alias of the same network type as the DPC's true point code. If the message contains a CGPA PC, either it must have an alias of the same network type as the new DPC, or the Discard CGPA PC option for the original network type must be on.

For SCCP messages which receive GTT by the EAGLE, the message's DPC, OPC and CDPA are not converted and thus may not need alias point codes. The message's DPC is a result of GTT translation does not need conversion. The OPC is the EAGLE's OPC of the same network type as the DPC's network. If the message contains a CGPA PC, either it must have an alias of the same network type as the new DPC, or the Discard CGPA PC option for the original network type must be on.

For through-switched SCCP management messages, the message's DPC, OPC, and affected point code must have an alias of the destination network type.

For EAGLE originated SCCP messages, a mated application's PC(s) must have aliases of the same network types as the concerned point code group's PC(s).

Alias point codes are configured using the "Adding a Destination Point Code" procedure, for adding a new destination point code with an alias point code, or the "Changing a Destination Point Code" procedure, for changing the alias point code value for an existing destination point code. The "Adding a Destination Point Code" and "Changing a Destination Point Code" procedures are found in Chapter 2, Configuring Destination Tables in *Database Administration - SS7 User's Guide*.

Interaction with FLOBR/TOBR feature

All translations (CdPA GTA, CgPA GTA, CgPA PC, OPC, DPC, CgPA SSN, CdPA SSN and Opcode) support ANSI/ITU/CHINA SCCP Conversion feature. As a result of the ANSI/ITU/CHINA SCCP Conversion feature, the MSU can be routed to a different network domain. This is detected by comparing the incoming network domain against the network domain of the result of GTT (including GTT loadsharing).

ANSI/ITU/CHINA SCCP Conversion performs GTT on CgPA, one of 2 methods will be used:

- If the translation includes a CgPA Conversion Set (as defined by `cgcnvsn` parameter), then that set will be used with the CgPA GTA information from MSU to perform GTT in "CdPA-only" mode. Failure to locate translation information in the CgPA Conversion Set will fall back to Default Conversion GT information.
- If the translation does not include a CgPA Conversion Set, then CGPA selectors and GT digits from MSU will be used to perform GTT in CDPA only mode.

 **Note:**

This is how OBSR is implemented; However, with FLOBR it is possible that the "CdPA-only mode" entry in the GTT Selector table is not CdPA GTT type, which will cause GTT on CgPA to fail.

Support of SCCP XUDT Messages

The Support of SCCP XUDT Messages feature allows the global title translation feature and the following SCCP services to process XUDT messages.

- G-FLEX – supported for segmented or non-segmented XUDT messages. G-Flex Map Layer Routing only supports non-segmented XUDT messages.
- INP – Message Relay service supports segmented and non-segmented XUDT messages. Call related query service (INP-QS) only supports non-segmented XUDT messages.
- G-PORTMNP - XUDT response generation (that is, XUDTSRI_ack), when an XUDT SRI message is received, is supported if the SRI is not segmented. G-PORT treats any segmented message (SRI or non-SRI) as a non-SRI message and message relay is performed on the message. G-PORT Message Relay is supported for all non-SRI messages, including segmented and non-segmented, Class 0 and Class 1.
- A-PORT MNP - XUDT response generation, when an XUDT LocationRequest message is received, is supported if the XUDT message is not segmented. A-PORT treats any segmented message as a non-LocationRequest message and message relay is performed on the message. A-PORT Message Relay is supported for all non-LocationRequest messages, including segmented and non-segmented, Class 0 and Class 1.
- EAGLE's IS-41 to GSM Migration - XUDT response generation, when an XUDT/GSMSRI, XUDTGSMSRI_for_SM, XUDT IS-41 LocationRequest, and XUDT IS-41 SMSRequest is received is supported if the message received by the EAGLE is not segmented. If the messages are segmented, the EAGLE performs message relay.
- GSM MAP Screening/Enhanced GSM MAP Screening - GSM MAP Screening (GMS) and Enhanced GSM MAP Screening (EGMS) supports screening on non-segmented XUDT messages, but does not support screening on segmented XUDT messages. If a segmented XUDT message is received on a linkset which has GMS or EGMS activated, GMS/EGMS is bypassed for that message, even if the parameters in the message match the provisioned screening rules. The SCCP processing of the message continues.
- Intermediate GTT Loadsharing - Class 0 and Class 1 SCCP XUDT messages are supported.

- Prepaid SMS Intercept (PPSMS) supports only non-segmented XUDT messages.
- MNP Check for MOSMS (MNPSMS) supports only non-segmented XUDT messages.

The following features do not support this feature:

- North American Local Number Portability (LNP)
- ANSI-ITU SCCP Conversion
- GSM Equipment Identity Register (EIR)

XUDT messages can be screened by Gateway Screening and all gateway screening stop actions can be applied to XUDT messages.

In-Sequence Delivery of Class 1 UDT Messages

The In-Sequence Delivery of Class 1 UDT Messages provides for the sequencing for both UDT and XUDT Class 1 MSUs. All UDT/XUDT Class 1 messages are routed out of the EAGLE in the same order that they were received by the EAGLE. To enable the sequencing of UDT/XUDT Class 1 messages, the `class1seq` parameter value of the `chg-sccpopts` command is set to `on`.

When the `class1seq` parameter value is `on`, load sharing of these messages is performed in the dominant mode, overriding the load sharing configuration in the MAP and MRN tables. Delivering the UDT/XUDT Class 1 ITU messages in sequence is guaranteed only if the `randsls` parameter value of the `chg-stpopts` command is either `off` or `class0`. If you wish to guarantee delivering these messages in sequence, the `class1seq=on` and the `randsls=all` parameters should not be used together in the EAGLE. The value of the `randsls` parameter is shown in the `rtrv-stpopts` command.

When the `class1seq` parameter value is `off`, load sharing of the UDT/XUDT Class 1 messages is performed using the load sharing configuration in the MAP and MRN tables. The delivery of the UDT/XUDT Class 1 messages in sequence is not guaranteed.

▲ Caution:

If the `randsls` parameter value of the `chg-stpopts` command is `all`, thus activating the Random SLS feature for ITU Class 1 SCCP messages, the UDT/XUDT Class 1 messages are not delivered in sequence. To ensure that Class 1 UDT/XUDT messages are delivered in sequence, the `randsls` parameter value should be set to either `off` or `class0`.

▲ Caution:

However, if the `randsls` parameter value of the `chg-stpopts` command is `all`, Class 1 UDT/XUDT messages are load shared across equal cost destinations by the Weighted SCP Load Balancing and Intermediate Global Title Load Sharing (IGTTLS) features. If the `randsls` parameter value of the `chg-stpopts` command is either `off` or `class0`, load sharing for all Class 1 SCCP messages is supported only in the dominant mode.

If the messages are not in the correct sequence when they arrive at the EAGLE, they are not delivered to the next node in the correct sequence. The EAGLE does not perform message re-sequencing for messages that are received out of sequence, because the EAGLE is a transit node. Message re-sequencing is the responsibility of the originating and destination nodes.

GT-routed Class 0 UDT/XUDT messages are not sequenced, therefore, the EAGLE does not guarantee routing these messages out of the EAGLE in the same order that they were received.

Flexible GTT Load Sharing

Flexible GTT Load Sharing (FGTTLS) provides more routing diversity for GTT traffic. There are two parts to Flexible GTT Load Sharing: Flexible Intermediate GTT Load Sharing applied to GTT traffic requiring intermediate global title translation, and Flexible Final GTT Load Sharing applied to traffic requiring final global title translation. See the following sections for details:

- [Flexible Intermediate GTT Load Sharing](#)
- [Flexible Final GTT Load Sharing](#)

Flexible Intermediate GTT Load Sharing

Flexible Intermediate GTT Load Sharing provides more flexible GTT load sharing arrangements for GTT traffic requiring intermediate global title translation (the routing indicator in the message is GT) than the load sharing arrangements provided by the Intermediate GTT Load Sharing feature. For the EAGLE to perform Flexible Intermediate GTT Load Sharing, the Flexible GTT Load Sharing and Intermediate GTT Load Sharing features must be enabled and turned on.

Intermediate Load Sharing Feature Only

With the Intermediate GTT Load Sharing feature enabled and turned on and the Flexible GTT Load Sharing feature *not* enabled, the EAGLE load shares post-GTT destinations when intermediate global title translation is being performed through the use of the MRN table. The destination point codes in the MRN table can appear in the MRN table only once. The MRN table contains groups of point codes with a maximum of 128 point codes in each group. This arrangement allows only one set of relationships to be defined between a given point code and any other point codes in the MRN group. All global title addresses in the GTT table that translate to a point code in the given MRN group will have the same set of load sharing rules applied.

For example, the following point codes and relative cost values are provisioned in the MRN table.

PC	RC
005-005-005	10
006-001-001	10
006-001-002	10
006-001-003	10
006-001-004	10
006-001-005	10
006-001-006	10
006-001-007	10

When the point code in the intermediate global title translation is translated to 005-005-005, all traffic routed using the global title addresses in the global title translations containing this point code are load shared equally, no matter what the global title address is.

Addition of Flexible GTT Load Sharing Feature

When the Intermediate GTT Load Sharing and the Flexible GTT Load Sharing features are enabled and turned on (thus allowing Flexible Intermediate GTT Load Sharing to be performed), the intermediate GTT load sharing arrangements are determined by the following:

- The MRN set assigned to the global title translation
- The translated point code in the message assigned to the global title translation
- The global title address in the message assigned to the global title translation

When a global title address in a global title translation is translated to a point code, the MRN set assigned to the global title translation and containing the translated point code determines how load sharing is applied to the traffic for this global title translation.

An MRN set is a group of point codes in the MRN table defining the GTT load sharing rules that are applied to a global title translation. The method of load sharing is determined by the relative cost (RC) value assigned to each point code in the MRN set. There are three types of load sharing that can be performed:

- Dominant
- Load shared
- Combined dominant/load shared

Dominant

All the point codes in a dominant MRN set have different relative cost values. The translated point code in the message is the preferred point code that the message is routed on. The relative cost value assigned to the preferred point code does not have to be the lowest value in the MRN set. All traffic is routed to the preferred point code, if it is available. If the preferred point code becomes unavailable, the traffic is routed to next alternate point code. When the preferred point code becomes available again, the traffic is then routed back to the preferred point code.

The following shows sample output from the `rtrv-mrn` command for a dominant map set.

MRNSET	PC	RC
DFLT	225-200-167	10
	225-200-163	20
	225-200-165	30
	225-200-164	40
	225-200-160	50

For example, if the preferred point code is 225-200-164 (relative cost 40) and it becomes unavailable, the traffic is routed to 225-200-160 (relative cost 50). If that point code is unavailable, the next point code that is attempted is at the top of the list, 225-200-167 (relative cost 10).

Load shared

All the point codes in a load shared MRN set have the same relative cost value. Traffic is shared equally between the point codes in this type of MRN set.

The following shows sample output from the `rtv-mrn` command for a load shared map set.

MRNSET	PCN	RC
DFLT	15608	10
	15728	10
	15720	10
	15712	10
	15704	10
	15696	10
	15688	10
	15680	10
	15672	10
	15664	10
	15656	10
	15648	10
	15640	10
	15632	10
	15624	10
	15616	10

Combined dominant/load shared

A combined dominant/load shared MRN set is a combination of the dominant and load sharing MRN sets. At least two of the point codes in the MRN set have the same relative cost value, and at least one other point code has a different relative cost. The traffic is shared equally among the point codes with the same relative cost values. If the point codes with the same relative cost as the preferred point code all become unavailable, the traffic is routed to the next set of point codes in the MRN set and shared equally between them.

The following shows sample output from the `rtv-mrn` command for a combined dominant/load shared map set.

MRNSET	PC	RC
DFLT	225-200-175	10
	225-200-174	20
	225-200-171	20
	225-200-173	30
	225-200-170	30
	225-200-172	40
	225-200-169	40
	225-200-168	50

In this example, if the preferred point code is 225-200-173, the traffic is shared between the two point codes with a relative cost of 30. If those become unavailable, the traffic is routed to the point codes with a relative cost of 40. If those become unavailable, the traffic gets routed to the point code with a relative cost of 50. If that point code becomes unavailable, the traffic is routed back of the top of the list to the primary point code that has a relative cost of 10.

 **Note:**

EAGLE allows up to 128 entities to be configured in MRN or MAP set with same relative cost value. However, traffic will only be load shared among 100 point codes.

Point Code Assigned to Multiple MRN Sets

With the Flexible GTT Load Sharing feature enabled, the same point code can be assigned to multiple MRN sets. The relative cost value of this point code in each MRN set can be different.

In the following example, the point code 002-002-002 is assigned to three MRN sets.

MRNSET	PC	RC
1	225-200-999	5
	002-002-002	10
	225-200-174	20
	225-200-171	30
	225-200-173	40

MRNSET	PC	RC
2	225-200-173	20
	225-200-174	20
	225-200-171	20
	002-002-002	20
	225-200-170	20
	225-200-172	20
	225-200-169	20
	225-200-168	20

MRNSET	PC	RC
3	004-004-004	20
	225-200-174	20
	225-200-170	30
	002-002-002	30
	225-200-172	30
	225-200-169	40
	225-200-168	40

In MRN set 1, point code 002-002-002 is in a dominant MRN set and has a relative cost value of 10. In MRN set 2, point code 002-002-002 is one of eight point codes in a load shared MRN set, each with a relative cost value of 20. In MRN set 3, point code 002-002-002 is assigned the relative cost value of 30 in a combined dominant/load shared MRN set whose primary (first) point code is 004-004-004 with a relative cost value of 20.

MRN set 1 is assigned to a global title translation containing the global title address of 9195551212. When the point code in this intermediate global title translation is translated to 002-002-002, point code 002-002-002 handles all the traffic for this intermediate global title translation until this point code becomes unavailable. When point code 002-002-002 becomes unavailable, the next point code (225-200-174) in this dominant MRN set handles the traffic until this point code becomes unavailable, or until point code 002-002-002 becomes available again.

MRN set 2 is assigned to a global title translation containing the global title address of 8285551212. When the point code in this intermediate global title translation is translated to 002-002-002, the traffic for this intermediate global title translation is shared equally among all members of the MRN set.

MRN set 3 is assigned to a global title translation containing the global title address of 3365551212. When the point code in this intermediate global title translation is translated to 002-002-002, the traffic for this intermediate global title translation is shared equally among all members of the MRN set with the relative cost value of 30, including 002-002-002. When all of these point codes become unavailable, the traffic is shared equally among all the point codes with the relative cost value of 40. If these point codes become unavailable, the traffic is shared equally among the point codes with the relative cost of 20.

By allowing a point code to be assigned to multiple MRN sets, and by assigning an MRN set to a specific global title address, different load sharing arrangements can be made based on the global title address of the global title translation and the translated point code.

The same MRN set can be assigned to multiple global title translations.

For the EAGLE to perform Flexible Intermediate GTT Load Sharing, the Flexible GTT Load Sharing feature must be enabled with the `enable-ctrl-feat` command, and turned on with the `chg-ctrl-feat` command. Perform the [Activating the Flexible GTT Load Sharing Feature](#) procedure to enable and turn on the Flexible GTT Load Sharing feature. The Intermediate GTT Load Sharing feature must also be enabled with the `enable-ctrl-feat` command, and turned on with the `chg-ctrl-feat` command. Perform the [Activating the IGTTLS feature](#) procedure to enable and turn on the Intermediate GTT Load Sharing feature.

The Flexible GTT Load Sharing feature can also be turned off with the `chg-ctrl-feat` command. If the Flexible GTT Load Sharing feature is turned off, and the Intermediate GTT Load Sharing feature enabled and turned on, provisioning for Flexible Intermediate GTT Load Sharing can be performed with the `ent-mrn`, `dlt-mrn`, `chg-mrn`, and `rtrv-mrn` commands. The EAGLE will not perform Flexible Intermediate GTT Load Sharing on GTT traffic requiring intermediate global title translation. Perform the [Turning Off the Flexible GTT Load Sharing Feature](#) procedure to turn off the Flexible GTT Load Sharing feature.

Flexible Final GTT Load Sharing

Flexible Final GTT Load Sharing provides more routing diversity for GTT traffic requiring final global title translation (the routing indicator in the message is SSN) than the load sharing arrangements provided by the mated applications without the Flexible GTT Load Sharing feature enabled. For the EAGLE to perform Flexible Final GTT Load Sharing, the Flexible GTT Load Sharing feature must be enabled and turned on.

Final Load Sharing Feature Only

With the Flexible GTT Load Sharing feature *not* enabled, the EAGLE load shares post-GTT destination point codes and subsystems when final global title translation is being performed by using the mated application (MAP) table. The destination point codes and subsystems in the MAP table can appear in the MAP table only once. The MAP table contains groups of point codes with a maximum of 128 point codes and subsystems in each group. This arrangement allows only one set of relationships to be defined between a given point code and subsystem and any other point codes and

subsystems in the MAP group. All global title addresses in the GTT table that translate to a point code and subsystem in the given MAP group will have the same set of load sharing rules applied.

For example, the following point codes, subsystems, and relative cost values are provisioned in the MAP table.

PCA	Mate PCA	SSN	RC	MULT	SRM	MRC	GRP NAME	SSO
005-005-005		251	10	SHR	*Y	*Y	grp01	OFF
	006-001-001	254	10	SHR	*Y	*Y	grp01	OFF
	006-001-002	254	10	SHR	*Y	*Y	grp01	OFF
	006-001-003	254	10	SHR	*Y	*Y	grp01	OFF
	006-001-004	254	10	SHR	*Y	*Y	grp01	OFF
	006-001-005	254	10	SHR	*Y	*Y	grp01	OFF
	006-001-006	254	10	SHR	*Y	*Y	grp01	OFF
	006-001-007	254	10	SHR	*Y	*Y	grp01	OFF

When the point code and subsystem in the final global title translation is translated to 005-005-005, subsystem 251, all traffic routed using the global title addresses in the final global title translations containing this point code and subsystem are load shared equally, no matter what the global title address is.

Addition of Flexible GTT Load Sharing Feature

When the Flexible GTT Load Sharing feature enabled and turned on, allowing Flexible Final GTT Load Sharing to be performed, the GTT load sharing arrangements are determined by:

- The MAP set assigned to the final global title translation
- The translated point code and subsystem
- The global title address in the message assigned to the global title translation

When a global title address in a final global title translation is translated to a point code and subsystem, the MAP set assigned to the final global title translation containing the translated point code and subsystem determines how load sharing is applied to the traffic for this final global title translation.

A MAP set is a group of point codes and subsystems in the MAP table defining the GTT load sharing rules that are applied to a final global title translation. The method of load sharing is determined by the relative cost (RC) value assigned to each point code and subsystem in the MAP set. There are four types of load sharing that can be performed:

- Solitary
- Dominant
- Load sharing
- Combined dominant/load sharing

Solitary

A solitary MAP set contains only one point code and subsystem and no mate point codes and subsystems. Traffic can be routed only to this point code and subsystem.

The following shows sample output from the `rtrv-map` command for a solitary map set.

```
MAPSET ID=1      MRNSET ID=---- MRNPC=-----
PCI             Mate PCI      SSN RC MULT SRM MRC GRP NAME SSO WT %WT THR
7-111-1                255 10 SOL *N *N  ----- OFF - - - - -
```

Dominant

All the point codes in a dominant MAP set have different relative cost values. The translated point code and subsystem in the message is the preferred point code and subsystem that the message is routed on. The relative cost value assigned to the preferred point code and subsystem does not have to be the lowest value in the MAP set. All traffic is routed to the preferred point code and subsystem if it is available. If the preferred point code and subsystem becomes unavailable, the traffic is routed the next alternate point code and subsystem that is available. When the preferred point code and subsystem becomes available again, the traffic is then routed back to the preferred point code and subsystem.

The following shows sample output from the `rtrv-map` command for a dominant map set.

```
MAPSET ID=30
PCA             Mate PCA      SSN RC MULT SRM MRC GRP NAME SSO
254-007-221                218 10 COM YES *Y  ----- OFF
                        254-007-220 234 15 COM YES *Y  ----- OFF
                        254-007-219 250 20 COM YES *Y  ----- OFF
                        254-007-234  10 25 COM YES *Y  ----- OFF
                        254-007-233  26 30 COM YES *Y  ----- OFF
                        254-007-232  42 35 COM YES *Y  ----- OFF
                        254-007-231  58 40 COM YES *Y  ----- OFF
                        254-007-230  74 45 COM YES *Y  ----- OFF
```

In this example, the preferred point code and subsystem is 254-007-231, subsystem 58 (relative cost 40). If that point code and subsystem becomes unavailable, the traffic is routed down the list to the next available point code and subsystem (relative cost 45). If that point code and subsystem becomes unavailable, the traffic is routed to the top of the list to that primary point code and subsystem (relative cost 10), and so on.

Load shared

All the point codes and subsystems in a load shared MAP set have the same relative cost value. Traffic is shared equally between the point codes and subsystems in this type of MAP set.

The following shows sample output from the `rtrv-map` command for a load shared map set.

```
MAPSET ID=32
PCA             Mate PCA      SSN RC MULT SRM MRC GRP NAME SSO
254-007-219                250 10 SHR *Y *Y  ----- OFF
                        254-007-234  14 10 SHR *Y *Y  ----- OFF
                        254-007-233  26 10 SHR *Y *Y  ----- OFF
                        254-007-232  42 10 SHR *Y *Y  ----- OFF
                        254-007-231  58 10 SHR *Y *Y  ----- OFF
```

254-007-230	74	10	SHR	*Y	*Y	-----	OFF
254-007-229	90	10	SHR	*Y	*Y	-----	OFF
254-007-228	106	10	SHR	*Y	*Y	-----	OFF
254-007-227	122	10	SHR	*Y	*Y	-----	OFF
254-007-226	138	10	SHR	*Y	*Y	-----	OFF
254-007-225	154	10	SHR	*Y	*Y	-----	OFF
254-007-224	170	10	SHR	*Y	*Y	-----	OFF
254-007-223	186	10	SHR	*Y	*Y	-----	OFF
254-007-222	202	10	SHR	*Y	*Y	-----	OFF
254-007-221	218	10	SHR	*Y	*Y	-----	OFF
254-007-220	234	10	SHR	*Y	*Y	-----	OFF

Combined dominant/load shared

A combined dominant/load shared MAP set is a combination of the dominant and load sharing MAP sets. At least two of the point codes and subsystems in this MAP set have the same relative cost values, and at least one other point code and subsystem has a different relative cost value. The traffic is shared equally between the point codes and subsystems with the same relative cost values. If these point codes and subsystems become unavailable, the traffic is routed to the next point codes and subsystems in the MAP set and shared equally between these point codes and subsystems.

The following shows sample output from the `rtrv-map` command for a combined dominant/load shared map set.

```
MAPSET ID=31
PCA          Mate PCA      SSN RC MULT SRM MRC GRP NAME SSO
254-007-220  254-007-219  234 10  COM YES *Y  ----- OFF
                254-007-234   10 10  COM YES *Y  ----- OFF
                254-007-233   26 10  COM YES *Y  ----- OFF
                254-007-228  106 10  COM YES *Y  ----- OFF
                254-007-227  122 10  COM YES *Y  ----- OFF
                254-007-226  138 10  COM YES *Y  ----- OFF
                254-007-225  154 10  COM YES *Y  ----- OFF
                254-007-232   42 20  COM YES *Y  ----- OFF
                254-007-231   58 20  COM YES *Y  ----- OFF
                254-007-230   74 20  COM YES *Y  ----- OFF
                254-007-229   90 20  COM YES *Y  ----- OFF
                254-007-224  170 20  COM YES *Y  ----- OFF
                254-007-223  186 20  COM YES *Y  ----- OFF
                254-007-222  202 20  COM YES *Y  ----- OFF
                254-007-221  218 30  COM YES *Y  ----- OFF
```

In this example, if the preferred point code is 254-007-231, subsystem 58 (relative cost 20), then the traffic is shared among the seven point codes/subsystems with a relative cost of 20. If those become unavailable, the traffic is sent to 254-007-221, subsystem 218, which has a relative cost of 30. Finally, if point code 254-007-221, subsystem 218 is unavailable, the traffic is shared among the point codes/subsystems with a relative cost of 10.

Point Code Assigned to Multiple MAP Sets

With the Flexible GTT Load Sharing feature enabled, the same point code and subsystem can be assigned to multiple MAP sets. The relative cost value of this point code and subsystem in each MAP set can be different.

In the following example, the point code 002-002-002, subsystem 254, is assigned to three MAP sets.

MAPSET ID=1

PCA	Mate PCA	SSN	RC	MULT	SRM	MRC	GRP NAME	SSO
002-002-002		254	10	COM	YES	*Y	-----	OFF
	254-007-219	250	20	COM	YES	*Y	-----	OFF
	254-007-234	10	25	COM	YES	*Y	-----	OFF
	254-007-233	26	30	COM	YES	*Y	-----	OFF
	254-007-232	42	35	COM	YES	*Y	-----	OFF
	254-007-231	58	40	COM	YES	*Y	-----	OFF
	254-007-230	74	45	COM	YES	*Y	-----	OFF

MAPSET ID=2

PCA	Mate PCA	SSN	RC	MULT	SRM	MRC	GRP NAME	SSO
254-007-219		250	20	SHR	*Y	*Y	-----	OFF
	254-007-234	14	20	SHR	*Y	*Y	-----	OFF
	254-007-233	26	20	SHR	*Y	*Y	-----	OFF
	254-007-232	42	20	SHR	*Y	*Y	-----	OFF
	002-002-002	254	20	SHR	*Y	*Y	-----	OFF
	254-007-230	74	20	SHR	*Y	*Y	-----	OFF
	254-007-229	90	20	SHR	*Y	*Y	-----	OFF
	254-007-228	106	20	SHR	*Y	*Y	-----	OFF

MAPSET ID=3

PCA	Mate PCA	SSN	RC	MULT	SRM	MRC	GRP NAME	SSO
004-004-004		200	20	COM	YES	*Y	-----	OFF
	254-007-219	250	20	COM	YES	*Y	-----	OFF
	254-007-234	10	30	COM	YES	*Y	-----	OFF
	254-007-233	26	30	COM	YES	*Y	-----	OFF
	002-002-002	254	30	COM	YES	*Y	-----	OFF
	254-007-227	122	40	COM	YES	*Y	-----	OFF
	254-007-226	138	40	COM	YES	*Y	-----	OFF

In MAP set 1, point code 002-002-002, subsystem 254, is the primary (first) point code and subsystem in a dominant MAP set with a relative cost value of 10. In MAP set 2, point code 002-002-002, subsystem 254, is one of eight point codes and subsystems in a load shared MAP set, each with a relative cost value of 20. In MAP set 3, point code 002-002-002, subsystem 254, is assigned the relative cost value of 30 in a combined dominant/load shared MAP set whose primary point code and subsystem is 004-004-004, subsystem 200, with a relative cost value of 20.

MAP set 1 is assigned to a global title translation containing the global title address of 9195551212. When the point code and subsystem in this final global title translation is translated to 002-002-002, subsystem 254, this point code and subsystem handles all the traffic for this final global title translation until it becomes unavailable. When point code 002-002-002, subsystem 254 becomes unavailable, the next point code and subsystem (254-007-219, subsystem 250) in this dominant MAP set handles the traffic until this point code and subsystem become unavailable, or until point code 002-002-002, subsystem 254 becomes available again.

MAP set 2 is assigned to a global title translation containing the global title address of 8285551212. When the point code and subsystem in this final global title translation is translated to 002-002-002, subsystem 254, the traffic for this final global title translation is shared equally among all members of the MAP set.

MAP set 3 is assigned to a global title translation containing the global title address of 3365551212. When the point code and subsystem in this final global title translation is translated to 002-002-002, subsystem 254, the traffic for this final global title translation is shared equally among all members of the MAP set with the relative cost value of 30, including point code 002-002-002, subsystem 254. When all of these point codes and subsystems with a relative cost value of 30 become unavailable, the traffic is shared equally among all the point codes and subsystems with the relative cost value of 40. If those with a relative cost of 40 also become unavailable, the traffic is shared equally among all the point codes and subsystems with the relative cost of 20.

By allowing a point code and subsystem to be assigned to multiple MAP sets, and by assigning a MAP set to a specific global title address, different load sharing arrangements can be made based on the global title address of the global title translation and the translated point code and subsystem.

The same MAP set can be assigned to multiple global title translations.

For the EAGLE to perform Flexible Final GTT Load Sharing, the Flexible GTT Load Sharing feature must be enabled with the `enable-ctrl-feat` command, and turned on with the `chg-ctrl-feat` command. Perform the [Activating the Flexible GTT Load Sharing Feature](#) procedure to enable and turn on the Flexible GTT Load Sharing feature.

The Flexible GTT Load Sharing feature can also be turned off with the `chg-ctrl-feat` command. If the Flexible GTT Load Sharing feature is turned off, provisioning for Flexible Final GTT Load Sharing can be performed with the `ent-map`, `dlt-map`, `chg-map`, and `rtrv-map` commands. The EAGLE will not perform Flexible Final GTT Load Sharing on GTT traffic requiring final global title translation. Perform the [Turning Off the Flexible GTT Load Sharing Feature](#) procedure to turn off the Flexible GTT Load Sharing feature.

Origin-Based SCCP Routing

The Origin-Based SCCP Routing feature provides additional options for routing SCCP messages. Without the Origin-Based SCCP Routing feature enabled, the routing of SCCP messages is based only on the called party address fields in the message. With the Origin-Based SCCP Routing feature enabled, SCCP messages can be routed based on the called party address (CdPA), the calling party address (CgPA), CgPA point code, CgPA subsystem number, or originating point code (OPC) fields in the message.

Origin-Based SCCP Routing provides three modes of global title translation:

- CdPA global title translation
- CgPA global title translation
- Advanced CdPA global title translation

The CgPA global title translation and Advanced CdPA global title translation modes are performed only if the Origin-Based SCCP Routing feature is enabled and turned on.

The CdPA global title translation mode is performed whether or not the Origin-Based SCCP Routing feature is enabled and turned on.

The CdPA global title translation mode is based on the CdPA global title address, translation type, and global title indicator in the incoming message. If the global title indicator value in the message is 4, the CdPA numbering plan and nature of address indicator is also used in the CdPA global title translation mode.

The CgPA global title translation mode is based on this criteria.

- CgPA global title address, translation type, global title indicator, and subsystem number in the incoming message. If the global title indicator value in the message is 4, the CgPA numbering plan and nature of address indicator is also used in the CgPA global title translation mode.
- CgPA point code, translation type, global title indicator, and subsystem number in the incoming message. If the global title indicator value in the message is 4, the CgPA numbering plan and nature of address indicator is also used in the CgPA global title translation mode.

The Advanced CdPA global title translation mode is based on this criteria.

- The CdPA global title address
- The CgPA global title address, or CgPA point code, or Selector ID. If the Selector ID is used in the Advanced CdPA global title translation mode, the CgPA translation type and CgPA global title indicator are also used in the Advanced CdPA global title translation mode if the CgPA global title indicator value is not 0. If the CgPA GTI value is 0, then the CGPC GTT set name shown in the `rtrv-sccpopts` output is used to determine the global title translation performed on the message.
- The CgPA subsystem number
- The OPC from the MTP Routing Label
- The CdPA translation type
- The CdPA global title indicator
- If the global title indicator value in the message is 4, the CdPA numbering plan and nature of address indicator is also used in the Advanced CdPA global title translation mode and in the CgPA global title translation mode

GTT Mode Hierarchy

The GTT mode hierarchy determines the preference of GTT modes used by the global title translation process on an incoming message. The global title translation process starts with the first GTT mode of the GTT hierarchy. If the translation was found there, the global title translation process is stopped. If the translation was not found in this first GTT mode, the global title translation process tries to find a translation in the next GTT mode of the hierarchy. The GTT mode hierarchies are shown in the following list.

1. CdPA only
2. Advanced CdPA, CdPA
3. CgPA, Advanced CdPA, CdPA
4. Advanced CdPA, CgPA, CdPA
5. Advanced CdPA, CdPA, CgPA

6. CgPA, CdPA
7. CdPA, CgPA
8. CgPA only

For example, GTT hierarchy 3 (CgPA, Advanced CdPA, CdPA) is selected for the global title translation process. When an incoming message is processed, the CgPA global title translation information is searched first, starting with a search in GTT selector table for CgPA selectors. If no match is found, the advanced CdPA global title translation information is searched next, including a search in GTT selector for CdPA selectors. If no match is found, the CdPA global title translation information is searched. If a match is still not found, the message is handled as a failed GTT lookup and the appropriate action is taken. When a match is found, the global title translation process is stopped and the message is processed according to the global title translation routing data.

The GTT mode hierarchy can be configured on a system wide basis and on a per linkset basis. The system wide option is configured using the `df1tgttmode` parameter of the `chg-sccpopts` command and is used to define the default GTT mode hierarchy value for all linksets by default. Each linkset can be configured to use one of the GTT mode hierarchies using the `gttmode` parameter of either the `ent-1s` or `chg-1s` command. The linkset option overrides the system default GTT mode value for only that linkset. If the `gttmode` parameter is not specified for a specific linkset, the system default GTT mode hierarchy is assigned to the linkset.

CdPA GTT Mode

The GTT functionality in previous releases of the EAGLE is now the CdPA GTT mode. The CdPA translation type and global title indicator in the incoming messages are used to select the GTT table (GTT set) used to process the message. If the global title indicator value in the message is 4, the CdPA numbering plan and nature of address indicator are also used to select the GTT table used to process the message. Once the GTT table is selected, the CdPA global title address determines how the message is translated.

Advanced CdPA GTT Mode

The Advanced CdPA GTT mode provides greater flexibility to route SCCP messages. CdPA GTA translation, along with either one or both of the following types of translations:

- CgPA GTA or CgPA point code translation identified by a pre-provisioned GTT set in the CdPA translation or by a search in GTT selector table using the SELID value from the CdPA translation along with other CgPA selectors, with or without a subsequent CgPA subsystem number translation. The CgPA GTA, CgPA point code, and SELID translations are mutually exclusive.
- OPC translation, with or without a subsequent CgPA subsystem number translation.

The translations are executed in a predefined order as displayed in the previous list and cannot be changed.

These additional translations can be applied on top of the mandatory CdPA GTA translation:

- CgPA GTA translation only
- CgPA GTA and CgPA subsystem number translation

- CgPA point code translation only
- CgPA point code and CgPA subsystem number translation
- Translation based on the SELID
- CgPA GTA and OPC translation
- CgPA GTA, OPC, and CgPA subsystem number translation
- CgPA point code and OPC translation
- CgPA point code, OPC, and CgPA subsystem number translation
- SELID and OPC translation
- SELID, OPC, and CgPA subsystem number translation
- OPC translation only
- OPC and CgPA subsystem number translation

 **Note:**

The CdPA global title indicator is always validated before GTT starts processing SCCP messages. The CgPA global title indicator is not validated, which means, that when a subsequent lookup in the Advanced CdPA GTT mode is based on the SELID value, the attempt to find a CgPA GTT set in GTT selector table may fail because of an invalid or unsupported CgPA global title indicator in the incoming message.

CgPA GTT Mode

The CgPA GTT mode offers two options for translating and routing SCCP messages, the CgPA GTA translation with or without a subsequent CgPA subsystem number translation, or the CgPA point code translation with or without a subsequent CgPA subsystem number translation search. The CgPA GTA and CgPA point code are mutually exclusive.

When CgPA global title translation performs a lookup in the GTT selector table, two new selectors, the CgPA subsystem number and SELID, are always members of the selectors. If CgPA global title translation performs a lookup in the GTT selector table as a part of Advanced CdPA global title translation because the SELID is specified in the CdPA entry, the only GTT selector match that will be found is the entry with this particular SELID. If CgPA global title translation performs a lookup in the GTT selector table in the CgPA GTT mode, the only GTT selector match that will be found is the entry with the SELID value equal to `NONE`.

The CgPA subsystem number for GTT selector lookups is used differently. If the MSU contains a CgPA subsystem number, then the first and the best match that will be found is the entry with this particular CgPA subsystem number. If the MSU does not have a CgPA subsystem number or if the match for a specific CgPA subsystem number was not found, CgPA global title translation attempts to find a GTT selector entry with the CgPA subsystem number equal to `ANY`, along with the rest of the selectors.

 **Note:**

The CdPA global title indicator is always validated before global title translation starts processing SCCP messages, even when the GTT mode is CgPA and the CdPA data is not used by global title translation. The CgPA global title indicator is not validated, which means, that the attempt to find a CgPA GTT set in the GTT selector table may fail because of an invalid or unsupported CgPA global title indicator in the incoming MSU.

Interaction with the Advanced GT Modification Feature

Any kind of SCCP translation (CdPA GTA, CgPA GTA, CgPA PC, OPC, SSN) can be provisioned with Advanced GT Modification data. This Advanced GT Modification data will be applied to a CdPA GTA if it exists, or to a CgPA GTA if it exists. If the CdPA or CgPA part of the message under translation does not contain a GTA, the Advanced GT Modification data from this translation will be ignored. The CdPA GTA is modified only if it is provisioned in a CdPA GTA set. If the CdPA GTA is provisioned in a CdPA GTA set, the CdPA GTA is not modified. The only exception to this is discussed in the [Interaction with the ANSI/ITU SCCP Conversion Feature](#) section.

Interaction with the ANSI/ITU SCCP Conversion Feature

When the ANSI/ITU SCCP Conversion feature attempts to perform a global title translation lookup on the CgPA in the message, the GTT hierarchy of the incoming linkset is ignored. The EAGLE performs a CdPA only global title translation using the CgPA data. The selectors from the CgPA part are used to find a CdPA GTA set in the GTT selector table, and the CgPA global title address is used to find a translation in the CdPA GTA set.

Interaction with MPS-based Features

The messages from the MPS-based services are processed by global title translation using the GTT mode assigned to the linkset on which these messages arrived at the EAGLE.

GTT for EAGLE-generated MSUs

UDTS messages and responses generated by the EAGLE and the required global title translation are processed in the CdPA GTT mode only.

Wildcard Provisioning for the OPC and CgPA Point Code

Origin-Based SCCP Routing allows for the use of wildcards (asterisks) as values for an ANSI OPC or ANSI CgPA point code.

For example, the point code value 12-*. * indicates that any ANSI point code containing with the network indicator value 12, regardless of the network cluster and network cluster member values in the ANSI point code, is considered a match.

The point code value 12-34- * indicates that any ANSI point code containing the network indicator value 12 and the network cluster value 34, regardless of the network cluster member value in the ANSI point code, is considered a match.

When searches for ANSI point codes are performed, the search order tries to find the best possible match. For example, the incoming message contains the ANSI point code 12-24-25. The search mechanism first searches for the point code value

12-34-25 in the global title translation tables. If that search fails, the search mechanism searches for the point code value 12-34-* in the global title translation tables. If that search fails, the search mechanism searches for the point code value 12-*-* in the global title translation tables.

An ANSI OPC or ANSI CgPA point code value containing all asterisks is not allowed. Asterisks cannot be used for ITU point codes.

The Cluster Routing and Management Diversity or Network Routing features do not have to be turned on to use asterisks for the ANSI OPC or ANSI CgPA point code value.

Provisioning the Origin-Based SCCP Routing Feature

To provision the Origin-Based SCCP Routing feature, perform these steps.

1. Turn the GTT and EGTT features on using the `chg-feat` command. Add the required E5-SM8G-B or SLIC cards to the database using the `ent-card` command. Enter the `rtrv-card` command to verify the cards that are provisioned in the database. Perform the [Adding a Service Module](#) procedure.
2. Enable the Origin-Based SCCP Routing feature using the `enable-ctrl-feat` command. Enter the `rtrv-ctrl-feat` command to verify the status of the Origin-Based SCCP Routing feature. Perform the [Activating the Origin-Based SCCP Routing Feature](#) procedure.

Note:

The Origin-Based SCCP Routing feature can be turned on in this step using the `chg-ctrl-feat` command. If the Origin-Based SCCP Routing feature is not turned on in this step, provisioning for the Origin-Based SCCP Routing feature can still be performed except for provisioning the Origin-Based SCCP Routing GTT mode hierarchy for linksets and system wide default GTT mode option with one of the Origin-Based SCCP Routing GTT mode hierarchies. The Origin-Based SCCP Routing GTT mode hierarchy for linksets and system wide default GTT mode option with one of the Origin-Based SCCP Routing GTT mode hierarchies can be provisioned only when the Origin-Based SCCP Routing feature is enabled and turned on. When the provisioning is completed, the Origin-Based SCCP Routing feature can be turned on. The Origin-Based SCCP Routing feature will not work until the feature is turned on either in this step or step 8.

3. Change the system wide default GTT mode, if desired, using the `chg-sccpopts` command. Enter the `rtrv-sccpopts` command to verify the system-wide default GTT mode value. Perform the [Changing the Default GTT Mode Options](#) procedure.
4. Provision the required destination point codes, linksets, signaling links, and routes, by performing these procedures in *Database Administration - SS7 User's Guide*.
 - Destination Point Codes – Adding a Destination Point Code procedure in *Database Administration - SS7 User's Guide*. Enter the `rtrv-dstn` command to verify the destination point codes that are provisioned in the database.
 - Linksets – Perform one of these procedures depending on the type of linkset. Enter the `rtrv-ls` command to verify the linksets that are provisioned in the database.

- SS7 Linkset – Adding an SS7 Linkset procedure in the *Database Administration - SS7 User's Guide*
- These procedures in *Database Administration - IP7 User's Guide*
 - * IP Gateway Linkset – Configuring an IPGWx Linkset
 - * IPSP M2PA Linkset – Adding an IPSP M2PA Linkset
 - * IPSP M3UA Linkset – Adding an IPSP M3UA Linkset

 **Note:**

If you wish to use a GTT mode hierarchy for the linkset other than the system default GTT mode hierarchy, specify the `gttmode` parameter when provisioning the linkset. The `gttmode` parameter values for the Origin-Based SCCP Routing GTT hierarchy can be specified only when the Origin-Based SCCP Routing feature is enabled and turned on.

- Signaling Links – Perform one of these procedures depending on the type of signaling link. Enter the `rtrv-slk` command to verify the signaling links that are provisioned in the database.
 - A low-speed SS7 signaling link – Adding an SS7 Signaling Link procedure in *Database Administration – SS7 User's Guide*
 - An E1 signaling link – Adding an E1 Signaling Link procedure in *Database Administration – SS7 User's Guide*
 - A T1 signaling link – Adding a T1 Signaling Link procedure in *Database Administration – SS7 User's Guide*
 - An ATM signaling link – Adding an ATM High-Speed Signaling Link procedure in *Database Administration – SS7 User's Guide*
 - These procedures in *Database Administration – IP7 User's Guide*
 - * IPLIMx Signaling Link – Adding an IPLIMx Signaling Link
 - * IPGWx Signaling Link – Adding an IPGWx Signaling Link
 - * IPSP M2PA Signaling Link – Adding an IPSP M2PA Signaling Link
 - * IPSP M3UA Signaling Link – Adding an IPSP M3UA Signaling Link
 - Routes – Perform one of these procedures in *Database Administration - SS7 User's Guide* depending on the type of route. Enter the `rtrv-rte` command to verify the routes that are provisioned in the database.
 - A route containing an SS7 DPC – Adding a Route Containing an SS7 DPC procedure
 - A route containing a cluster point code – Adding a Route Containing a Cluster Point Code procedure
 - A route containing an IPGWx Linkset – Adding a Route Containing an IPGWx Linkset procedure
5. Provision the required GTT sets using the `ent-gttset` command. Enter the `rtrv-gttset` command to verify the GTT sets that are provisioned in the database. Perform the [Adding a GTT Set](#) procedure.

6. Provision the required GTT translations using the `ent-gta` command. Enter the `rtrv-gta` command to verify the GTT translations that are provisioned in the database. Perform the [Adding Global Title Address Information](#) procedure.

 **Note:**

The command line on the terminal can contain up to 150 characters. If the parameters and values specified with the `ent-gta` command are too long to fit on the `ent-gta` command line, perform the `chg-gta` command to complete adding the GTA entry. If the parameters and values specified with the `chg-gta` command are too long to fit on the `chg-gta` command line, perform the `chg-gta` command as many times as necessary to complete the GTA entry.

7. Provision the required GTT selectors using the `ent-gttsel` command. Enter the `rtrv-gttsel` command to verify the GTT selectors that are provisioned in the database. Perform the [Adding a GTT Selector](#) procedure.

 **Note:**

Performing this step is not required depending on how the GTT sets in Step 5 and the GTA entries in Step 6 are configured.

8. Turn the Origin-Based SCCP Routing feature on using the `chg-ctrl-feat` command. Perform the [Activating the Origin-Based SCCP Routing Feature](#) procedure.

 **Note:**

If the required database entity is shown in the output of the retrieve command for that database entity, the procedure for provisioning the database entity does not need to be performed.

Hex Digit Support for GTT

The Hex Digit Support for GTT feature, when enabled, allows the EAGLE to process incoming messages that contain either decimal (0-9) or hexadecimal digits (0-9, a-f, A-F) in the global title address in the called party address field of the messages.

If the Hex Digit Support for GTT feature is enabled and the Origin-Based SCCP Routing feature is enabled and turned on, the EAGLE can process messages containing decimal or hexadecimal digits in the global title address in either the calling party address or the called party address fields of the messages, depending on the GTT hierarchy that is used to process the messages. For more information on the Origin-Based SCCP Routing feature, refer to the [Origin-Based SCCP Routing](#) section.

With the Hex Digit Support for GTT feature enabled, hexadecimal digits can be specified for the `gta` and `egta` parameters of the `ent-gtt`, `chg-gtt`, `ent-gta`, and `chg-gta` commands. If the Advanced GT Modification feature is enabled, hexadecimal digits can be specified for the values of the prefix and suffix deletion

digit parameters (`npds` and `nsds`) of the `ent-gtmod`, and `chg-gtmod` commands. For more information on the Advanced GT Modification feature, refer to the [Advanced GT Modification Feature](#) section.

If the ANSI/ITU SCCP Conversion feature is enabled, hexadecimal digits can be specified for the values of the prefix and suffix deletion digit parameters (`npds` and `nsds`) of the `ent-gtcnv` or `chg-gtcnv` commands. For more information on the ANSI/ITU SCCP Conversion feature, refer to the [ANSI/ITU SCCP Conversion Feature](#) section.

After the Hex Digit Support for GTT feature is enabled, any existing range entries for global title addresses are treated as a range of hexadecimal values instead of a range of decimal values. For example, the database contains an entry that contains the range of global title addresses from 20 to 30. With the Hex Digit Support for GTT feature not enabled, this translation would match MSUs containing the global title addresses 20, 21, 22, 23, 24, 25, 26, 27, 28, 29, and 30. With the Hex Digit Support for GTT feature enabled, this translation would match MSUs containing the global title addresses 20, 21, 22, 23, 24, 25, 26, 27, 28, 29, 2A, 2B, 2C, 2D, 2E, 2F, and 30. Translations containing a single entry for the global title address are not changed.

If you wish to have different translated data for hexadecimal digits, the existing range entry can be split into 3 entries as follows in [Table 2-1](#).

Table 2-1 Hex Digit Range Example

GTA=20	EGTA=29	with existing translation data
GTA=2A	EGTA=2F	with user specified translation data
GTA=30		with existing translation data

Hexadecimal digits cannot be used as a value for the `gta` parameter for the `ent-gws-redirect` and `chg-gws-redirect` commands.

Hexadecimal digits can be used as values for GSM MAP screening entries only if the Enhanced GSM MAP Screening feature is enabled.

Provisioning the Hex Digit Support for GTT Feature

To provision the Hex Digit Support for GTT feature, perform these steps.

1. Turn the GTT feature on using the `chg-feat` command. Add the required service modules to the database using the `ent-card` command. Perform the [Adding a Service Module](#) procedure. If Enhanced Global Title Translation will be used, turn the EGTT feature on using the `chg-feat` command.
2. Enable the Hex Digit Support for GTT feature using the `enable-ctrl-feat` command. Perform the [Activating the Hex Digit Support for GTT Feature](#) procedure.

Note:

Once this feature is enabled, the feature is also turned on. The `chg-ctrl-feat` cannot be used to turn this feature on. Once this feature is enabled, the feature cannot be turned off.

3. Provision the required destination point codes, linksets, signaling links, and routes, by performing these procedures.
 - Destination Point Codes - Adding a Destination Point Code procedure in *Database Administration - SS7 User's Guide*.
 - Linksets - Perform one of these procedures depending on the type of linkset.
 - SS7 Linkset - Adding an SS7 Linkset procedure in *Database Administration - SS7 User's Guide*
 - These procedures in *Database Administration - IP7 User's Guide*.
 - * IP Gateway Linkset - Configuring an IPGWx Linkset
 - * IPSP M2PA Linkset - Adding an IPSP M2PA Linkset
 - * IPSP M3UA Linkset - Adding an IPSP M3UA Linkset
 - Signaling Links - Perform one of these procedures depending on the type of signaling link.
 - A low-speed SS7 signaling link - Adding an SS7 Signaling Link procedure in *Database Administration - SS7 User's Guide*
 - An E1 signaling link - Adding an E1 Signaling Link procedure in the *Database Administration Manual - SS7*
 - A T1 signaling link - Adding a T1 Signaling Link procedure in *Database Administration - SS7 User's Guide*
 - An ATM signaling link - Adding an ATM High-Speed Signaling Link procedure in *Database Administration - SS7 User's Guide*
 - These procedures in *Database Administration - IP7 User's Guide*.
 - * IPLIMx Signaling Link - Adding an IPLIMx Signaling Link
 - * IPGWx Signaling Link - Adding an IPGWx Signaling Link
 - * IPSP M2PA Signaling Link - Adding an IPSP M2PA Signaling Link
 - * IPSP M3UA Signaling Link - Adding an IPSP M3UA Signaling Link
 - Routes - Perform one of these procedures in *Database Administration - SS7 User's Guide* depending on the type of route.
 - A route containing an SS7 DPC - Adding a Route Containing an SS7 DPC procedure
 - A route containing a cluster point code - Adding a Route Containing a Cluster Point Code procedure
 - A route containing an IPGWx Linkset - Adding a Route Containing an IPGWx Linkset procedure

 **Note:**

If only the GTT feature was turned on in step 1, perform steps 4 and 5. If the EGTT feature was turned on in step 1, skip steps 4 and 5 and perform steps 6, 7, and 8.

4. Provision the required translation types using the `ent-tt` command. Perform the [Adding a Translation Type](#) procedure.

5. Provision the required global title translations using the `ent-gtt` command. Perform the [Adding a Global Title Translation](#) procedure.

 **Note:**

After the required global title translations have been provisioned in step 5, skip steps 6, 7, and 8.

6. Provision the required GTT sets using the `ent-gttset` command. Perform the [Adding a GTT Set](#) procedure.
7. Provision the required GTT translations using the `ent-gta` command. Perform the [Adding Global Title Address Information](#) procedure.

 **Note:**

The command line on the terminal can contain up to 150 characters. If the parameters and values specified with the `ent-gta` command are too long to fit on the `ent-gta` command line, perform the `chg-gta` command to complete adding the GTA entry. If the parameters and values specified with the `chg-gta` command are too long to fit on the `chg-gta` command line, perform the `chg-gta` command as many times as necessary to complete the GTA entry.

8. Provision the required GTT selectors using the `ent-gttset` command. Perform the [Adding a GTT Selector](#) procedure.

Weighted GTT Load Sharing

The default behavior of the EAGLE for performing load sharing between nodes with the same relative cost is to perform the load sharing in a round-robin fashion. A limitation of this design is that all destinations have equal processing power and should receive an equal load. However, as new hardware is added to load-sharing groups, the load-sharing groups may have different processing capabilities. Customization of the load-sharing group would allow the traffic load to be distributed on the individual characteristics of each destination.

Another default behavior of the EAGLE is to route traffic to a load-shared group if any member of that group with the relative cost value is available. Depending on the traffic, this can overwhelm and congest a node, even though other nodes at different relative cost values could have handled the traffic.

Both of these scenarios can be solved with the Weighted GTT Load Sharing feature, which allows unequal traffic loads to be provisioned in mated application (MAP) and mated relay node (MRN) load sharing groups.

The MAP and MRN load sharing groups can be MAP or MRN load sharing groups without the Flexible GTT Load Sharing enabled, or MAP or MRN sets with the Flexible GTT Load Sharing feature enabled. Weighted GTT Load Sharing can be applied to only load shared or combined dominant/load shared MAP or MRN groups, and cannot be applied to solitary mated applications, or dominant MAP or MRN groups.

This feature also allows provisioning control over load sharing groups so that if insufficient capacity within the load sharing group is available, the load sharing group is not used.

Weighted GTT Load Sharing provides two controls for GTT traffic distribution through either the MAP or MRN groups:

- Individual weighting for each entity in a relative cost (RC) group
- In-Service threshold for each RC group

An RC group is a group of entries in either a MAP group or an MRN group that have the same relative cost value. An entity is either a point code entry in the MRN table or a point code and subsystem number entry in the MAP table.

A MAP group or MRN group can also be referred to as an entity set.

Weighted GTT Load Sharing can be applied to only load shared or combined dominant/load shared MAP or MRN groups, and cannot be applied to solitary mated applications, or dominant MAP or RN groups.

Individual Weighting

Individual weighting is a method for assigning a different load capacity to each member of an RC group. Each entity is assigned a weight from 1 to 99 and receives a percentage of the traffic equal to its weight relative to the RC group's total weight. To calculate the percentage of traffic that a particular entity receives within its RC group (assuming all nodes are active and available for traffic), use the following equation:

$$\% \text{ of traffic for the entity} = (\text{weight value assigned to the entity} / \text{RC group weight}) \times 100\%$$

Note:

With round-robin load-sharing, there is a concept of the preferred entity. The preferred entity is the outcome of GTT. It is the first entity used for load-sharing after initialization, and is the primary entity for Class 1 SCCP Sequenced traffic. When weights are applied, no entity has any preference over another based on GTT information. Distribution is based on the RC group chosen by GTT, not the specific entity.

Individual Weighting Example

Table 2-2 shows how weighting affects traffic delivery. Entity A has a weight of 40 and the total RC group weight is 110, entity A receives 36% of the traffic. Entity C has a weight of 10 and receives only 9% of the traffic for this group. The total group weight is the sum of the individual weight values assigned to each entity in the group.

Note:

In order to maintain 100% for the RC group, some rounding may occur. This rounding error will always be $\pm 1\%$.

Table 2-2 RC Group Weight Example

Entity	RC	Weight	RC Group Weight	Percentage of Traffic
A	10	40	110	$(40 / 110) * 100\% = 36\%$
B	10	30		$(30 / 110) * 100\% = 27\%$
C	10	10		$(10 / 110) * 100\% = 9\%$
D	10	30		$(30 / 110) * 100\% = 28\%$

If all entities in an RC group have the same weight, the outbound traffic pattern provides equal distribution. For weighted load shared or weighted combined load shared MRN or MAP groups with In-Sequence Class 1 SCCP option on, In-Sequence Class 1 SCCP traffic is routed using the provisioned data as the initial method of routing and dynamic data (if the entity selected by provisioned data is prohibited) as the secondary method of routing. This allows all Class 1 traffic to be delivered to the same destination, and the traffic routing is affected unless the original destination changes status. If Transaction-Based GTT Load Sharing is not turned on, then the Weighted GTT Load Shared MSU Key is used. This provides a consistent MSU Key for the Class 1 SCCP traffic based on MTP parameters.

An MSU Key is a value calculated from parameters of an MSU that allows the MSU to be assigned to an entity within an RC group. An MSU Key always maps to the same entity until there is a status change to the MAP or MRN group.

In-Service Threshold

The in-service threshold defines the minimum percentage of weight that must be available for an RC group to be considered available. If the percentage of the available weight is less than the in-service threshold, then the entire RC group is considered unavailable for traffic. If the percentage of the available weight is equal to or greater than the in-service threshold, then the RC group is considered available, and traffic can be sent to any available entity in the RC group. The in-service threshold helps to prevent congestion when only a small portion of the RC group is available.

The in-service threshold has an initial value of 1%, and has a range of values from 1% to 100%. Current round-robin load sharing has an in-service threshold value of 1%, where if any entity in an RC group is available, it is always used.

The group weight that must be available to carry traffic (the required group weight) is determined by multiplying the total group weight (the sum of the individual weight values assigned to each entity in the group) by the in-service threshold value, expressed as a percentage. For example, if the RC group weight is 110, and the in-service threshold is 75%, the required group weight is 82.

An RC group can be in one of three states: Available, Prohibited, and Threshold-Prohibited. These states are determined by comparing the required RC group weight to the weight of the entities that are actually available for traffic, the entity available weight.

If the state of the entity in the RC group is Available, the entity available weight is the weight value assigned to the entity. If the state of the entity in the RC group is either Congested or Prohibited, the entity available weight is 0. The sum of all entity available weights in the RC group is the RC group available weight. [Table 2-3](#) shows how the states of the RC group are determined.

Table 2-3 RC Group In-Service Threshold States

RC Group State	Description
Available	The RC group available weight is greater than or equal to the Required RC group weight. Traffic can be routed to the RC group in all circumstances.
Prohibited	All entities in the RC group are prohibited (the RC group Available Weight = 0). No traffic can be routed to this RC group.
Threshold-Prohibited	At least one entity in the RC group is not prohibited, but RC group available weight is less than the required RC group weight. Even if the RC group available weight is 0, if one entity is congested, then the state of the RC group is Threshold-Prohibited. Normally, no traffic is routed to this RC group. The Transaction-based GTT Load Sharing and the SCCP Class 1 Sequencing features may route traffic to this group if the primary node is congested. Instead of moving this transaction-based traffic to another node and then back quickly when the congestion abates, routing will continue to the primary node.

In-Service Threshold Example

In the example shown in [Table 2-4](#), the RC group consisting of entities A, B, C, and D does not have sufficient available weight for the group (70 is less than 82), and therefore the RC group is considered Threshold-Prohibited. This RC group is unavailable for traffic.

The RC group consisting of entities E and F does have sufficient available weight for the group, and the RC group is considered Available.

The RC group consisting of entities G and H is Prohibited, since both entities G and H are Prohibited.

The RC group consisting of entities I and J is Threshold-Prohibited, since entity I is Congested. In order for the RC group status to be Prohibited, all entities in the RC group must be Prohibited. Non-Transaction-Based GTT Load Sharing traffic is not routed to the RC group.

If the Transaction-Based GTT Load Sharing feature is enabled and turned on, or SCCP Class 1 Sequencing is used, then traffic can be routed to entity I if that is the primary entity for the traffic (traffic would be routed if entity I were Available).

Table 2-4 In-Service Threshold Example

Entity	RC Group Wt.	In-Service Threshold	Req. RC Group Wt.	Entity Status	Entity Avail. Wt.	RC Group Avail. Wt.	RC Group In-Service Threshold Status
A	40	75%	82	Available	40	70	Threshold - Prohibited
B	30			Prohibited	0		
C	10			Prohibited	0		

Table 2-4 (Cont.) In-Service Threshold Example

Entity	RC	Wt.	RC Group Wt.	In-Service Threshold	Req. RC Group Wt.	Entity Status	Entity Avail. Wt.	RC Group Avail. Wt.	RC Group In-Service Threshold Status
D	10	30				Available	30		
E	20	30	40	100%	40	Available	30	40	Available
F	20	10				Available	10		
G	30	20	70	50%	35	Prohibited	0	0	Prohibited
H	30	50				Prohibited	0		
I	40	25	50	50%	25	Congested	0	0	Threshold - Prohibited
J	40	25				Prohibited	0		

Load-Sharing Groups

Weighted GTT Load-Sharing can be applied to only load shared mated application or MRN groups, or combined dominant/load shared mated application or MRN groups.

A load shared MAP or MRN group is a MAP or MRN group containing entries whose RC (relative cost) values are equal.

When Weighted GTT Load Sharing is applied to load shared MAP or MRN groups, traffic is distributed among the entities according to:

- Entity Status – traffic is only routed to an entity if the entity is considered Available.
- Entity Available Weight – the entity receives a percentage of the traffic determined by its weight relative to the total available weight of the RC group.
- RC group status - refer to [Table 2-3](#).
- Available RC group weight – The sum of all entity available weights in the RC group.

[Table 2-5](#) shows an example of Weighted GTT Load Sharing applied to a load shared MAP or MRN group.

Table 2-5 Load Shared Group with Weighted GTT Load Sharing Example

Entity	RC	Weight	RC Group Weight	In-Service Threshold	Required RC Group Weight	Entity Status
A	10	40	110	50%	55	Available
B	10	30				Prohibited
C	10	10				Available
D	10	30				Available

Entity	Entity Available Weight	RC Group Available Weight	RC Group In-Service Threshold Status	MAP or MRN Group Status	Current Load %
A	40	80	Available	Available	50%
B	0				0
C	10				13%
D	30				37%

All entities in the load shared group are in the same RC group, so if the RC group is unavailable for traffic, all traffic is discarded.

A combined dominant/load shared MAP or MRN group is a MAP or MRN group containing a minimum of two entries whose RC (relative cost) values are equal and a minimum of one entry whose RC value is different.

When Weighted GTT Load Sharing is applied to combined dominant/load shared MAP or MRN groups, traffic is distributed among the entities according to:

- Entity Status – traffic is only routed to an entity if the entity is considered Available.
- Entity Available Weight – the entity receives a percentage of the traffic determined by its weight relative to the total available weight of the RC group.
- RC group status – refer to [Table 2-3](#).
- Available RC group weight – The sum of all entity available weights in the RC group.
- MRN or MAP Group Status – the MRN or MAP group must be considered Available in order to route traffic.

[Table 2-6](#) shows an example of a weighted combined load shared group.

Based on the results of global title translation, traffic is routed to one of the RC groups in the weighted combined load shared group. If that RC group is unavailable for traffic, the RC group with the next highest cost that is available for traffic is used to route the traffic. If a higher cost RC group is being used to route traffic, and a lower cost RC group becomes available, the lower cost RC group is then used to route the traffic.

The status of the combined dominant/load shared group is based on the status of the RC groups that make up the combined dominant/load shared group. If the status of any RC group is Available, then the status of the combined dominant/load shared group is Available. If no RC group is available for traffic, but the status of at least one of the RC groups is Threshold-Prohibited, then the status of the combined dominant/load shared group is Threshold-Prohibited. If the status of all the RC groups is Prohibited, then the status of the combined dominant/load shared group is prohibited.

Table 2-6 Combined Dominant/Load Shared Group with Weighted GTT Load Sharing Example

Entity	RC	Weight	RC Group Weight	In-Service Threshold	Required RC Group Weight	Entity Status
A	10	40	110	75%	82	Available
B	10	30				Prohibited

Table 2-6 (Cont.) Combined Dominant/Load Shared Group with Weighted GTT Load Sharing Example

Entity	RC	Weight	RC Group Weight	In-Service Threshold	Required RC Group Weight	Entity Status
C	10	10				Prohibited
D	10	30				Available
E	20	30	40	100%	40	Available
F	20	10				Available
G	30	10	10	1%	1	Available

Entity	Entity Available Weight	RC group Available Weight	RC group In-Service Threshold Status	MRN or MAP Group Status	Current Load %
A	40	70	Threshold - Prohibited	Available	0
B	0				0
C	0				0
D	30				0
E	30	40	Available		75%
F	10				25%
G	10	10	Available		100%

 **Note:**

The Current Load % column shows the percentage of traffic each entity in the RC group handles.

MSU Routing under Congestion

For Transaction-Based GTT Load Sharing or SCCP Class 1 Sequenced traffic, the original destination of the traffic must be maintained under congestion. Diverting traffic during congestion can lead to invalid transaction states, and the originator is not informed of any problem. If a congested node is selected, then traffic is routed to that node. If the message is discarded, then a UDTS is generated so the originator is informed of a problem. If the node is prohibited, then the selection of an alternate node is acceptable. This action is equivalent to the action performed when the `mrc=no` parameter is specified with either the `ent-map` or `chg-map` commands.

For all other traffic, rerouting this traffic away from a congested node is acceptable, since no sequencing or state information needs to be maintained. This can be accomplished by considering a congested entity as Unavailable (thus, its available weight is 0). The congested node receives no traffic. The state of the RC group may transition from Available to Threshold-Prohibited. This action is equivalent to the action performed when the `mrc=yes` parameter is specified with either the `ent-map` or `chg-map` commands.

Provisioning the Weighted GTT Load Sharing Feature

To provision the Weighted GTT Load Sharing feature, perform these steps.

1. Turn the GTT and EGTT features on using the `chg-feat` command. Add the required E5-SM4G cards to the database using the `ent-card` command. Perform [Adding a Service Module](#).
2. Enable the Weighted GTT Load Sharing feature using the `enable-ctrl-feat` command and turn the Weighted GTT Load Sharing feature on using the `chg-ctrl-feat` command. Perform [Activating the Weighted GTT Load Sharing Feature](#).
3. Provision load shared or combined dominant/load shared MRN groups with the `ent-mrn` and `chg-mrn` commands. To provision the MRN groups, the Intermediate GTT Load Sharing feature must be enabled with the `enable-ctrl-feat` command and turned on with the `chg-ctrl-feat` command. Perform [Activating the IGTTLS feature](#). Once the Intermediate GTT Load Sharing feature is enabled and turned on, perform [Provisioning MRN Entries](#).
4. Provision load shared or combined dominant/load shared MAP groups with the `ent-map` and `chg-map` commands. Perform one of these procedures:
 - [Provisioning a Solitary Mated Application](#).
 - [Provisioning a Dominant Mated Application](#).
 - [Provisioning a Load Shared Mated Application](#).
 - [Provisioning a Combined Dominant/Load Shared Mated Application](#).

Transaction-Based GTT Load Sharing

Transaction-Based GTT Load Sharing allows messages with the same transaction parameters (TCAP, SCCP, MTP, or ENHMTP parameters) to be routed to the same destination within an entity set. An entity set is a group of entities that are used to determine the proper destination of a post-GTT message. This group of entities can be one of the following:

- A mated application (MAP) group
- A mated relay node (MRN) group
- A mated application set (MAPSET), if the Flexible GTTLoad Sharing feature is enabled
- A mated relay node set (MRNSET), if the Flexible GTTLoad Sharing feature is enabled.

This feature applies to the following types of SCCP messages:

- UDT/UDTS class 0 messages
- UDT/UDTS class 1 messages
- XUDT/XUDTS class 0 messages
- XUDT/XUDTS class 1 messages.

UDT/UDTS and XUDT/XUDTS messages are loadshared using a key derived from these elements in the message.

- MTP parameters - the first 3 bytes of the incoming OPC and 1 byte of the SLS.
- SCCP parameters - the last 4 bytes of the global title address field of the called party address.
- TCAP parameter - the TCAP Transaction ID in the messages.
- Enhanced MTP parameter - a combination of the SLS and the incoming OPC values.

The parameters used for Transaction-Based GTT Load Sharing are selected using the `chg-sccpopts` command. These parameters are:

- `:tgtt0` – enable or disable Transaction-Based GTT Load Sharing for SCCP Class 0 UDT, UDTS, XU DT, or XU DTS messages.
- `:tgtt1` – enable or disable Transaction-Based GTT Load Sharing for SCCP Class 1 UDT, UDTS, XU DT, or XU DTS messages.
- `:tgttudtkey` – the Transaction Parameter for the incoming UDT or UDTS messages.
- `:tgttxudtkey` – the Transaction Parameter for the incoming XU DT or XU DTS messages.

[Figure 2-3](#) describes how the Transaction-Based GTT Load Sharing SCCP options are used.

Figure 2-3 Transaction-Based GTT Load Sharing SCCP Options

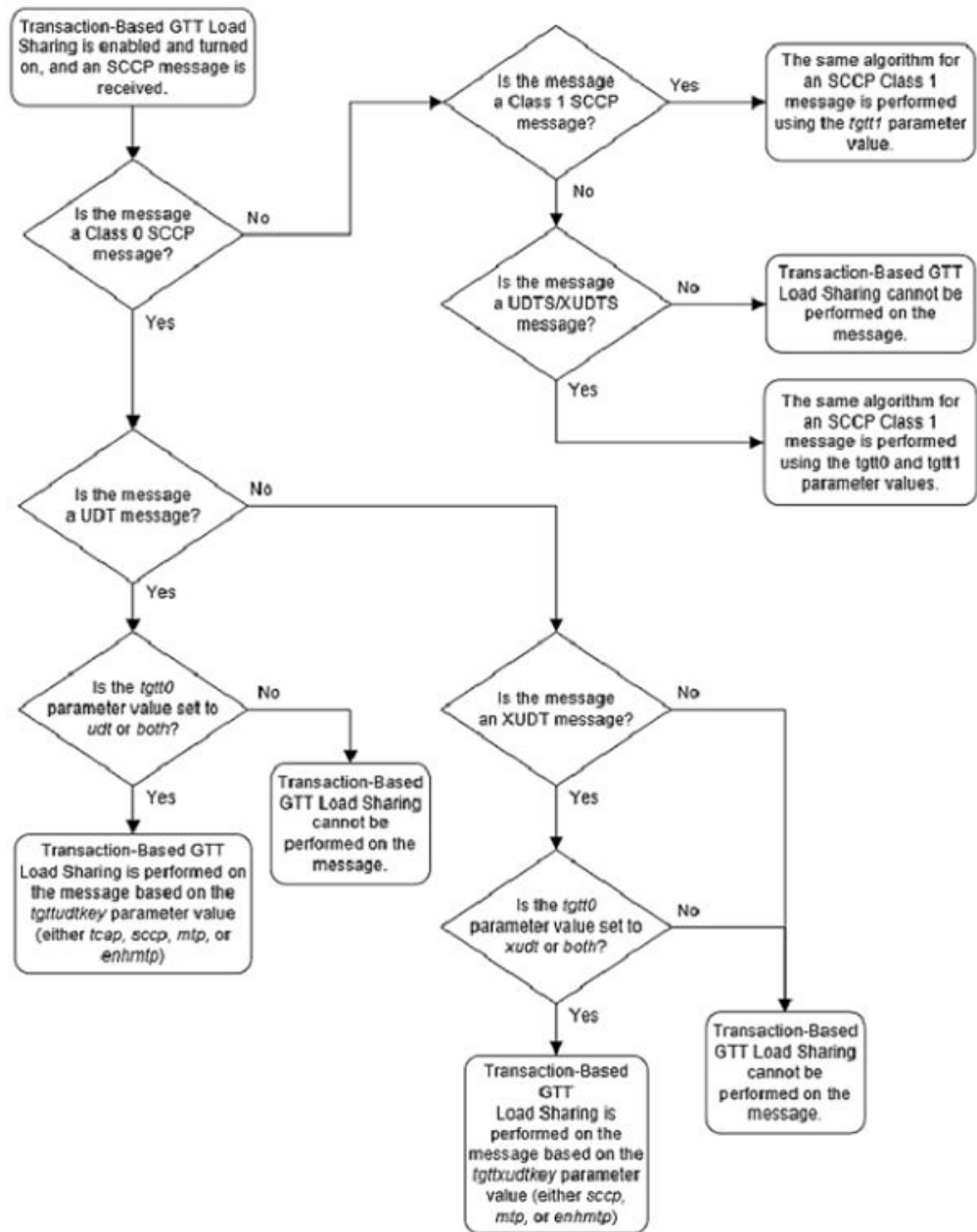

For more information on provisioning the Transaction-Based GTT Load Sharing option parameters, refer to the [Changing the Transaction-Based GTT Load Sharing Options](#) procedure.

Only load shared and combined dominant/load shared entity sets are used to determine the routing for messages that are processed by the Transaction-Based GTT Load Sharing feature.

Using a load shared entity set, the entire entity set is a part of one RC group and the messages are load-shared based on the Transaction Parameter in the entities in the entity set. If none of the entities in the entity set are available for routing, then the

message is discarded and a UDTS/XUDTS message is generated if "Return on Error" is set in the SCCP message. A UIM is generated indicating that the message has been discarded.

Using a combined dominant/load shared entity set, the RC group containing the point code, or point code and SSN, obtained as a result of the global title translation process is used to determine how the message is routed. If none of the entities in this RC group are available for routing, the next higher cost RC group is chosen. This is repeated until an entity in an entity set is available for routing. When an entity is found that is available for routing, the message is routed according to the criteria in that entity. If none of the entities in the entity set are available for routing, the message is discarded. A UDTS/XUDTS message is generated if "Return on Error" is set in the SCCP message. A UIM is generated indicating that the message has been discarded.

Once the MSU key is generated, it is passed to the Weighted GTT Load Sharing mode entity sets to determine how the message will be routed. If the Weighted GTT Load Sharing feature is active and weights have been assigned to the entity set, the Weighted GTT Load Sharing feature uses these weights to determine how to route the message. If no weights have been assigned to the entity set, then each RC group in the entity set is considered to be equally weighted.

Static routing is performed on all the messages that the Transaction-Based GTT Load Sharing feature has assigned an MSU key. Static routing always assigns an MSU key to the same node within an RC group. If static routing does not provide an available entity for routing the message, dynamic routing is used to find an available entity for routing the message. [Figure 2-4](#) illustrates this process.

Figure 2-4 Message Routing using Transaction-Based GTT Load Sharing

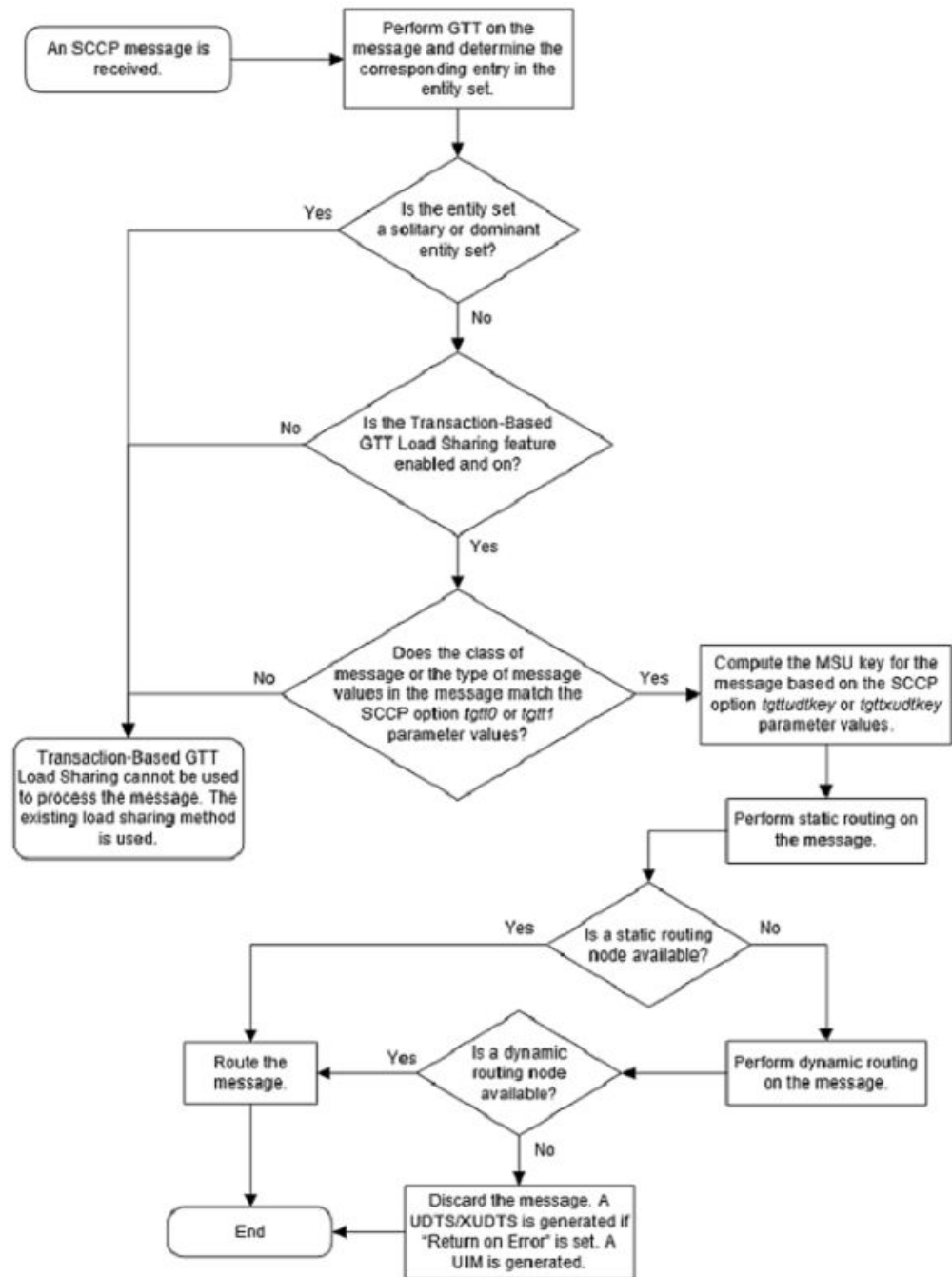

Provisioning the Transaction-Based GTT Load Sharing Feature

To provision the Transaction-Based GTT Load Sharing feature, perform these steps.

1. Turn the GTT and EGTT features on using the `chg-feat` command. Add the required DSMs or SLIC cards to the database using the `ent-card` command. Perform [Adding a Service Module](#).

2. Enable the Transaction-Based GTT Load Sharing feature using the `enable-ctrl-feat` command. Perform the [Activating the Transaction-Based GTT Load Sharing Feature](#) procedure.

 **Note:**

The Transaction-Based GTT Load Sharing feature can be turned on in this step using the `chg-ctrl-feat` command. If the Transaction-Based GTT Load Sharing feature is not turned on in this step, provisioning for the Transaction-Based GTT Load Sharing feature can still be performed. When the provisioning is completed, the Transaction-Based GTT Load Sharing feature can be turned on. The Transaction-Based GTT Load Sharing feature will not work until the feature is turned on either in this step or step 4.

3. Change the Transaction-Based GTT Load Sharing options, if desired, using the `chg-sccpopts` command. Perform the [Changing the Transaction-Based GTT Load Sharing Options](#) procedure.
4. Turn the Transaction-Based GTT Load Sharing feature on using the `chg-ctrl-feat` command. Perform the [Activating the Transaction-Based GTT Load Sharing Feature](#) procedure.

SCCP Loop Detection

This feature detects SCCP looping of UDT/UDTS and XUDT/XUDTS messages. The SCCP Loop Detection feature requires a feature access key (FAK) for part number 893-0165-01 to enable the feature.

Normally, an STP sends GTT messages to the capability point codes (CPCs) of mated nodes for load sharing. However, approach can result in SCCP looping if the destination point code is the same as the originating point code or the point code of any intermediate in the network.

This looping can be resolved by eliminating the use of CPCs and verifying at an intermediate STP whether the OPC of the incoming MSU is the same as the true point code (TPC) of the DPC after GTT. However, CPCs are often used to implement LNP in addition to the SCCP.

The SCCP Loop Detection feature resolves the looping issue by providing a correlation between the MTP-designated TPCs/secondary point codes (SPCs) and the CPCs for all concerned STPs.

The SCCP Loop Detection feature is provisioned by configuring the Loopset Table and adding a loopset to a to a Global Title Translation.

The loopset commands define the correlation between MTP-designated point codes and the capability point codes of the STPs that detect SCCP looping. The GTT commands allow the administration, deletion, and retrieval of loopset table entries for a particular Global Title Translation.

The SCCP Loop Detection feature operates in Regular or Discard modes. In the Regular (default) mode, the SCCP Loop Detection Feature generates a UIM when it detects SCCP looping but does not discard the MSU. This UIM allows the operator to capture and verify MSUs throughout the system for SCCP looping. In the Discard

mode, the SCCP Loop Detection feature generates a UIM when it detects SCCP looping and discards the MSU.

Provisioning the SCCP Loop Detection Feature

1. Enable the SCCP Loop Detection feature using the `enable-ctrl-feat` command. Perform the [Activating the SCCP Loop Detection Feature](#) procedure.

Note:

The SCCP Loop Detection feature can be turned on in this step using the `chg-ctrl-feat` command. If the SCCP Loop Detection feature is not turned on in this step, provisioning for the SCCP Loop Detection feature can still be performed. When the provisioning is completed, the SCCP Loop Detection feature can be turned on. The SCCP Loop Detection feature will not work until the feature is turned on in this step.

2. Provision the loopset table using the `ent-loopset` command. Perform the [Adding a Loopset](#) procedure.
3. Add a loopset to the global title translation using the `ent-gtt` or `ent-gta` commands. Perform [Adding a Global Title Translation](#) or [Adding Global Title Address Information](#).

Flexible Linkset Optional Based Routing

Flexible Linkset Optional Based Routing allows the EAGLE to route GTT traffic based on the incoming link set and to route GTT traffic based on a variety of parameters (MTP, SCCP and TCAP depending on features that are enabled and turned on) in a flexible order on a per-translation basis.

Flexible Linkset Optional Based Routing can be used with or without the Origin-Based SCCP Routing or the TCAP Opcode Based Routing features. Flexible Linkset Optional Based Routing can be enabled and turned on only if the EGTT feature is turned on. If only the Flexible Linkset Optional Based Routing is enabled and turned on, the name of the incoming linkset that will help to determine how the GTT traffic is routed can be provisioned in the GTT selectors. If the Origin-Based SCCP Routing feature or the TCAP Opcode Based Routing feature is used with the Flexible Linkset Optional Based Routing feature, the name of the incoming linkset can be provisioned along with the provisioning for the Origin-Based SCCP Routing or the TCAP Opcode Based Routing features. [Table 2-7](#) shows the type of GTT sets that can be provisioned for GTT selectors based on the features that are enabled and turned on.

Table 2-7 GTT Set Type and GTT Selector Combinations

Feature Combinations	GTT Set Types for CdPA GTT Selectors	GTT Set Types for CgPA GTT Selectors
EGTT Only	CdPA GTA	Not Applicable
Origin-Based SCCP Based Routing Only	CdPA GTA	CgPA GTA, CgPA Point Code
Flexible Linkset Optional Based Routing Only	CdPA GTA, CdPA SSN, DPC	CdPA GTA, CdPA SSN, DPC

Table 2-7 (Cont.) GTT Set Type and GTT Selector Combinations

Feature Combinations	GTT Set Types for CdPA GTT Selectors	GTT Set Types for CgPA GTT Selectors
Flexible Linkset Optional Based Routing and TCAP Opcode Based Routing	CdPA GTA, Opcode, CdPA SSN, DPC	CdPA GTA, Opcode, CdPA SSN, DPC
Flexible Linkset Optional Based Routing and Origin-Based SCCP Based Routing	CdPA GTA, CgPA GTA, CgPA SSN, CgPA Point Code, OPC, CdPA SSN, DPC	CdPA GTA, CgPA GTA, CgPA SSN, CgPA Point Code, OPC, CdPA SSN, DPC
Flexible Linkset Optional Based Routing, Origin-Based SCCP Based Routing, and TCAP Opcode Based Routing	CdPA GTA, CgPA GTA, CgPA SSN, CgPA Point Code, OPC, Opcode, CdPA SSN, DPC	CdPA GTA, CgPA GTA, CgPA SSN, CgPA Point Code, OPC, Opcode, CdPA SSN, DPC

Enhancements to Flexible Linkset Optional Based Routing

In previous releases, the GTT and TT command sets were replaced by the GTTSET, GTTSEL, and GTA command sets when the EGTT feature is turned on. Now the GTT and TT command sets can be used when EGTT feature is turned on.

In previous releases, the `selid` parameter in the `ent-gttset`, `dlt-gttset`, and `chg-gttset` commands could be configured only when the Flexible Linkset Optional Based Routing feature is enabled and turned on or the Origin-Based SCCP Routing feature is enabled. Now the `selid` parameter of these commands can be configured when the EGTT feature is turned on.

An SCCP message (RT-on-GT or MTP-routed) received by the EAGLE can be routed (Relayed or Redirected) to another destination based on the routing data obtained from the EPAP database or PPSOPTS table by the EPAP-based service. This type of message is called a Service Relayed MSU. In previous releases, global title translation is not performed on Service Relayed MSUs. These messages are directly sent to destination obtained from EPAP database or PPSOPTS table.

Now global title translation can be performed Service Relayed MSUs. To do this, these three optional parameters of the `ent-srvsel` and `chg-srvsel` commands are supported on per Service Selector basis for the non-GTT Message Relay Services.

- GTT Required (`on=gttrqd`, `off=gttrqd`) – This specifies whether or not global title translation is performed on Service Relayed MSUs. This parameter can be configured after the GTT feature is turned on.
- GTT Selector ID (`gttselid` for the `ent-srvsel` command, `ngttselid` for the `chg-srvsel` command) – This is used as the SELID value for the GTT selector search when global title translation is performed on the Service Relayed MSU. This parameter can be configured only after EGTT feature is turned on.
- Default Action (`dfltact` for the `ent-srvsel` command, `ndfltact` for the `chg-srvsel` command) – The action that is performed when the GTT selector search (using the GTT Selector ID from the Service Selector entry) fails for the Service Relayed MSU. This parameter can be configured only after EGTT feature is turned on or the GTT Action - DISCARD feature is enabled and turned on.

An example service selector entry is shown in [Figure 2-5](#).

Figure 2-5 Message Relay Services and GTT Actions

GTIA/ GTII/ GTIN/ GTIN24	Translation Type	Numbering Plan	Nature of Address Indicator	Subsystem Number	Service	GTT Required?	SELID	Default Action
4	1	1	2	4	GFLEX	Yes	100	Fall through to GTT or Discard/UDTS/TCAP Error GTT Action ID or Fallback to EPAP/ PPSOPTS Routing Data

The GTT Required option indicates whether global title translation needs to be performed after successfully finding the routing data from the EPAP database or PPSOPTS database for non-GTT Message Relay Services. If the routing data is not found for non-GTT Relay Services from the EPAP database or PPSOPTS database, the standard Fall through to GTT procedure shall be performed.

Fallback to GTT

Fallback to GTT allows global title translation to be performed on Service Relayed MSUs by using the GTT Required parameter on per Service Selector basis for the non-GTT Message Relay Services shown in [Table 2-8](#). Provisioning of the GTT Required parameter can be performed only if the EAGLE contains E5-SM4G cards.

Table 2-8 Services Supporting Fallback to GTT

Service Name	Corresponding Feature which may relay MSU-based on EPAP or PPSOPTS Data
MNP/GPORT	GPORT (Part Number: 893-0172-01) APORT (Part Number: 893-0166-01) IS41 GSM Migration (Part Number: 893-0173-01)
SMSMR	Prepaid SMS Intercept Ph1 (Part Number: 893-0067-01)
GFLEX	G-Flex MAP Layer Routing (Part Number: 893-0217-01) G-Flex (Part Number: 893-0219-01)
INPMR	ANSI-41 INP Query (Part Number: 893-0178-01) INP (Part Number: 893-0179-01)
IDPR	IDP A-Party Routing (Part Number: 893-0333-01) IDP Service Key Routing (Part Number: 893-0336-01)
TTR	Currently no feature in this service performs message relay without encountering global title translation. The GTT Required parameter has no effect on this service.

The GTT Required parameter is invoked only if a message is required to be relayed based on the routing data from EPAP database or PPSOPTS table after the successful execution of a non-GTT Message Relay Service. [Table 2-8](#) lists the non-GTT Message Relay Services and the corresponding feature(s) which may result in the message being relayed based on the routing data from EPAP database or PPSOPTS table. If the GTT Required parameter value indicates that global title translation is required on the Service Relayed MSU, then global title translation is performed on the MSU modified by the relay service according to GTT hierarchy of the incoming link set. The default value of GTT Required parameter is set to indicate that global title translation is not required on the Service Relayed MSU. If global title translation is performed on

the Service Relayed MSU successfully, then the message is processed through all the GTT-related features that are enabled and turned on.

 **Note:**

Fallback to GTT applies only to the Service Relayed MSU. Query/Response and standard Fall Through to GTT procedures are do not apply to Fallback to GTT.

Exceptions to Fallback to GTT

If a service performs global title translation on service specific parameters to obtain information required for message routing (for example, the MO SMS B-Party Routing feature in the SMSMR service finds the routing information by performing global title translation on the CDPN), then Fallback to GTT is not applied on those messages. The exceptions to Fallback to GTT are shown in [Table 2-9](#).

Table 2-9 Exceptions to Fallback to GTT

Service Name	Feature Name	Exception Description
MNP/GPORT	IS41 GSM Migration (Part Number: 893-0173-01)	The IGM SRI_SM Relay to Default IS41 SMSC functionality relays the message to the default IS41 SMSC based on the global title translation of the GTA defined by the DEFIS41SMSC value shown in the <code>rtvw-gsmmsmsopts</code> output.
	All features under the MNP/GPORT service.	The MNP/GPORT service allows re-routing of messages when the service is offline. In this case, a global title translation parameter is already present that specifies whether global title translation is required when the service is offline.
SMSMR	MO SMS B-Party Routing (Part Number: 893-0246-01)	MO SMS B-Party Routing performs global title translation on the TCAP B-Party digits (TCAP CDPN) and routes the message based on the global title translation results.
GFLEX	All features under the GFLEX service.	The GFLEX service allows re-routing of messages when the GFLEX service is offline. In this case, a global title translation parameter is already present that specifies whether global title translation is required when the service is offline.

The service selector search is not performed for the MTP-routed messages whose CDPA GTI value is 0 (zero). The parameters required to perform Fallback to GTT are not available for MTP-routed messages whose CDPA GTI value is 0 (zero). Fallback to GTT on Service Relayed MSUs does not apply to messages whose CDPA GTI value is 0 (zero). If a message whose CDPA GTI value is 0 (zero) is relayed by an EPAP-based service, then global title translation is not be performed on the message.

GTT Selector ID and the Service Selector

For the non-GTT Message Relay Services, shown in [Table 2-8](#), GTT selector IDs (SELIDs) can be provisioned. Only one GTT selector ID is allowed for each service

selector entry. The GTT selector ID is used to perform GTT selector searches while performing global title translation on the Service Relayed MSUs. The GTT selector ID is not used while performing global title translation as a part of the existing Fall through to GTT message processing. The GTT selector ID from service selector shall be used only in first GTT selector search. If further GTT selector searches are required (when the matching translation is provisioned with a CDSELID or CGSELID), then the GTT selector ID found from the previous matched translation is used as is currently done when processing the translation for the Origin-Based SCCP Routing and Flexible Linkset Optional Based Routing features. The default value for the GTT selector ID in the service selector entry is `none`. The GTT selector ID in the service selector can be provisioned when the EGTT feature is on. The Origin-Based SCCP Routing and Flexible Linkset Optional Based Routing features are not required to be enabled or turned on to provision the GTT selector ID in the service selector.

Default Action and the Service Selector

For the non-GTT Message Relay Services shown in [Table 2-8](#), a default action can be provisioned for each service selector entry. The default action parameter in the service selector can be one of these values.

- Fall through to GTT
- The Discard GTT Action ID
- The UDTS GTT Action ID
- The TCAP Error GTT Action ID
- Fallback (route the MSU based on the relay data)

The default action from the service selector is used only if the GTT selector search using the GTT selector ID from the service selector fails while performing global title translation on the Service Relayed MSU.

If the GTT selector search using the GTT selector ID from the service selector fails and the default action in the service selector is Fall through to GTT, then the action that is performed depends on the value of the GTT selector ID in the service selector. If the GTT selector ID value in the service selector is `none`, then the message is discarded and UIM 1042 is generated. If the GTT selector ID value in the service selector is not `none`, then the GTT selector search is attempted again with GTT selector ID value of `none`. If the subsequent GTT selector search, attempted with GTT selector ID value of `none`, also fails, then the message is discarded and UIM 1042 is generated.

If the GTT selector search using the GTT selector ID from the service selector fails and the default action value in the service selector is either the Discard GTT Action ID, UDTS GTT Action ID, or the TCAP Error GTT Action ID, then the corresponding GTT action is performed.

If the GTT selector search using the GTT selector ID from the service selector fails and the default action value in the service selector is Fallback, then the message is relayed based on the routing data from the EPAP database or PPSOPTS table.

Overall Functionality

After successfully getting the routing data for non-GTT Message Relay Services, if the GTT Required value is set to `Yes` and the GTT SELID is provisioned for this service, global title translation is performed on the MSU with specified SELID value to find the matching translation based on the GTT hierarchy on the linkset on which this MSU arrived.

- If a matching GTT selector is not found, the default action is applied to the MSU. The default action can be any of the actions shown in the [Default Action and the Service Selector](#) section. The default value of default action parameter is Fallback (route the MSU based on the relay data).
- If a global title translation is not found, then existing global title translation error handling procedures are applied.
- If a matching global title translation is found and:
 - If the matched global title translation contains routing data, the global title translation routing data is used on top of the EPAP or PPSOPTS routing data.
 - If the matched global title translation doesn't contain routing data (`xlat` parameter value is `none`), the MSU continues to use the EPAP or PPSOPTS routing data.
 - If the matched global title translation contains values for the `cggtmod` or `gtmodid` parameters, then the `cggtmod` parameter value or the parameter values contained in the GT modification entry that is defined by the `gtmodid` parameter are applied to the MSU.
 - If a GTT action set is associated with the matched translation, then the GTT Actions feature is applied to the MSU.
 - If matched translation contains a value for the `ccgt` parameter, then the `ccgt` parameter value is applied to the MSU as is currently done with the Advanced GT Modification feature.

Linkset Based Routing

After the Flexible Linkset Optional Based Routing feature enabled and turned on, Eagle considers the incoming link set as part of the GTT selection process for performing global title translation. If EAGLE receives MSUs with the same routing information on different link sets, it has the flexibility to route them based on different GTT rules. This also applies to the messages that fall through to GTT after being processed by MPS based services on the EAGLE. The incoming link set of the original MSU is used for these messages.

MSUs generated by the EAGLE that require global title translation are handled differently since they do not have a valid incoming link set. A separate set of GTT selector entries can be provisioned for these MSUs.

A separate set of GTT selector entries can be provisioned for messages generated by the EAGLE.

Flexible Linkset Optional Based Routing GTT Hierarchies

The Flexible Linkset Optional Based Routing feature introduced four more GTT hierarchies in addition to the GTT hierarchies used for the Origin-Based SCCP Routing feature. These hierarchies are shown in [Table 2-10](#). These GTT hierarchies are available only when the corresponding feature is enabled, and turned on if necessary. All the GTT hierarchies are available when both the Origin-Based SCCP Routing and the Flexible Linkset Optional Based Routing features are enabled, and turned on if necessary. The GTT hierarchy can be provisioned on a link set basis or a system wide basis. The default GTT hierarchy is CdPA only.

Table 2-10 GTT Hierarchies

EGTT Turned On Only	Origin-Based SCCP Routing Enabled Only	Flexible Linkset Optional Based Routing (FLOBR) Enabled and Turned On Only	Origin-Based SCCP Routing Enabled and Flexible Linkset Optional Based Routing Enabled and Turned On
CdPA only	CdPA only	CdPA only	CdPA only
	Advanced CdPA, CdPA	FLOBR CdPA only	Advanced CdPA, CdPA
	CgPA, Advanced CdPA, CdPA	FLOBR CgPA only	CgPA, Advanced CdPA, CdPA
	Advanced CdPA, CdPA, CgPA	FLOBR CgPA, FLOBR CdPA	Advanced CdPA, CdPA, CgPA
	CgPA, CdPA	FLOBR CdPA, FLOBR CgPA	CgPA, CdPA
	CdPA, CgPA		CdPA, CgPA
	CgPA only		CgPA only
			FLOBR CdPA only
			FLOBR CgPA only
			FLOBR CgPA, FLOBR CdPA
			FLOBR CdPA, FLOBR CgPA

When a Flexible Linkset Optional Based Routing GTT hierarchy is provisioned on a link set, the translations do not have to be searched in a predetermined fashion as is done for the Origin-Based SCCP Routing GTT hierarchies (a specific translation can only point to specific GTT set types and the CgPA SSN translation is the terminating point of the search). As long as a translation points to another GTT set/SELID, the search continues and this can lead to infinite searching. The number of searches is limited by these conditions.

- The same GTT set cannot be referred to more than once in the searching process.
- The number of database searches is limited to seven, including searches based on the calling party/called party SELID.

 **Note:**

The DPC and CDSSN GTT set types can be searched only in a Flexible Linkset Optional Based Routing GTT hierarchy.

Fallback Option

A fallback option can be provisioned for each translation that tells the EAGLE how to route an MSU under the these conditions:

- Routing when the subsequent search failed in the Flexible Linkset Optional Based Routing feature.
- Routing when the same GTT set name is referred to more than once.
- Limiting the number of database searches to seven for the Flexible Linkset Optional Based Routing feature.

The fallback option can be configured on a system wide basis and on a per-translation basis. The system wide option is configured using `df1tfallback` parameter of the `chg-sccpopts` command and is used to define the default value (“No”) for all translations by default. Each translation may then be configured to use one of the fallback values. The fallback option is configured with the `fallback` parameter of the `ent-gta` or `chg-gta` commands. The `fallback` parameter has these values.

- `sysdf1t` - use the `df1tfallback` parameter value of the `chg-sccpopts` command for the translation.
- `yes` - global title translation is performed based on the last matched entry.
- `no` - global title translation fails and the MSU is discarded.

The per-translation option overrides the system default just for that translation. The Origin-Based SCCP Routing hierarchies do not use the fallback option.

Routing when the Subsequent GTT Set Search Failed

In this example, Set 1 is used to start the search. The matching translation in Set 1 points to Set 2. The matching translation in Set 2 points to Set 3 and there is no matching translation found in Set 3. Since the fallback option for the matched translation in Set 2 set to No, the MSU is discarded.

Figure 2-6 Action When the Subsequent Translation Search Fails

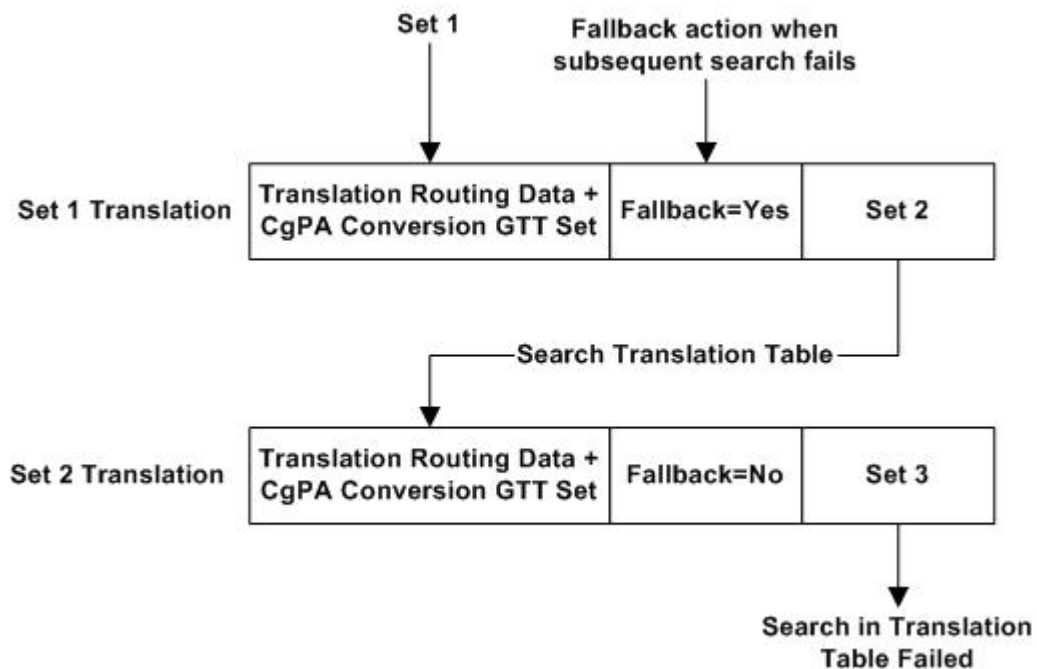

If the matching translation is not found in Set 2 (Set 2 Translation in Figure 2-6 is not found) and since the fallback option value in the Set 1 Translation is set to Yes, the MSU is routed based on the routing data in the Set 1 Translation. If the matching translation in Set 2 does not contain any GTT set/SELID combination (the Set 3 GTT set as shown in Figure 2-6 is not provisioned), then the fallback option is ignored and the MSU is routed based on routing data in the Set 2 Translation. If the matching translation in Set 1 is not found, then the GTT process fails.

Routing When the Subsequent Search for the SELID Fails

In this example, Set 1 is used to start the search. The matching translation in Set 1 (for example, a CdPA SSN/Opcode/CdPA GTA translation) contains SELID/Set 2 and also Set 3 (in this case Set 3 is an OPC GTT set).

Figure 2-7 Action When the Subsequent SELID Search Fails

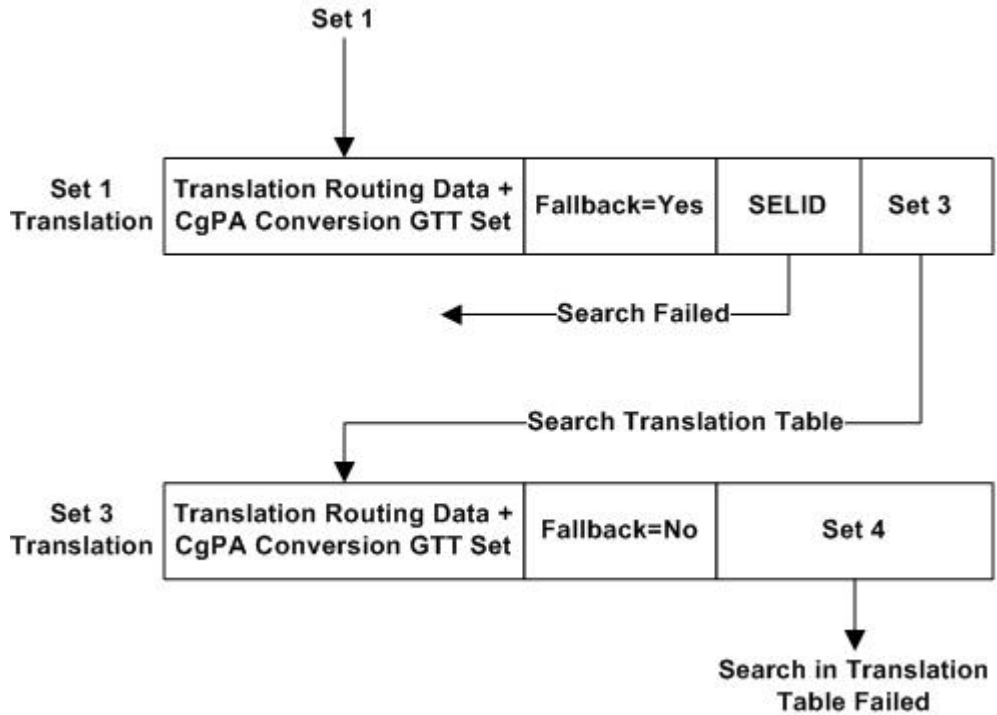

If a matching GTT selector is not found with an SELID in the Set 1 translation, the search continues searching for the matching translation in Set 3. If a matching translation is found in Set 3 and no matching translation is found in Set 4, the fallback option No in the Set 3 Translation is performed and the MSU is discarded. If a matching GTT selector is not found with an SELID in the Set 1 translation and a matching translation is not found in Set 3, the fallback option Yes in the Set 1 Translation is performed and the MSU is routed based on the routing data in the Set 1 Translation. If a GTT selector with an SELID results in a GTT set name that is already referred to, the action based on the fallback option in the Set 1 Translation is performed.

Routing When the Same GTT Set Name is Referred To More than Once

Figure 2-8 Action When the Same GTT Set Name is Referred to More Than Once

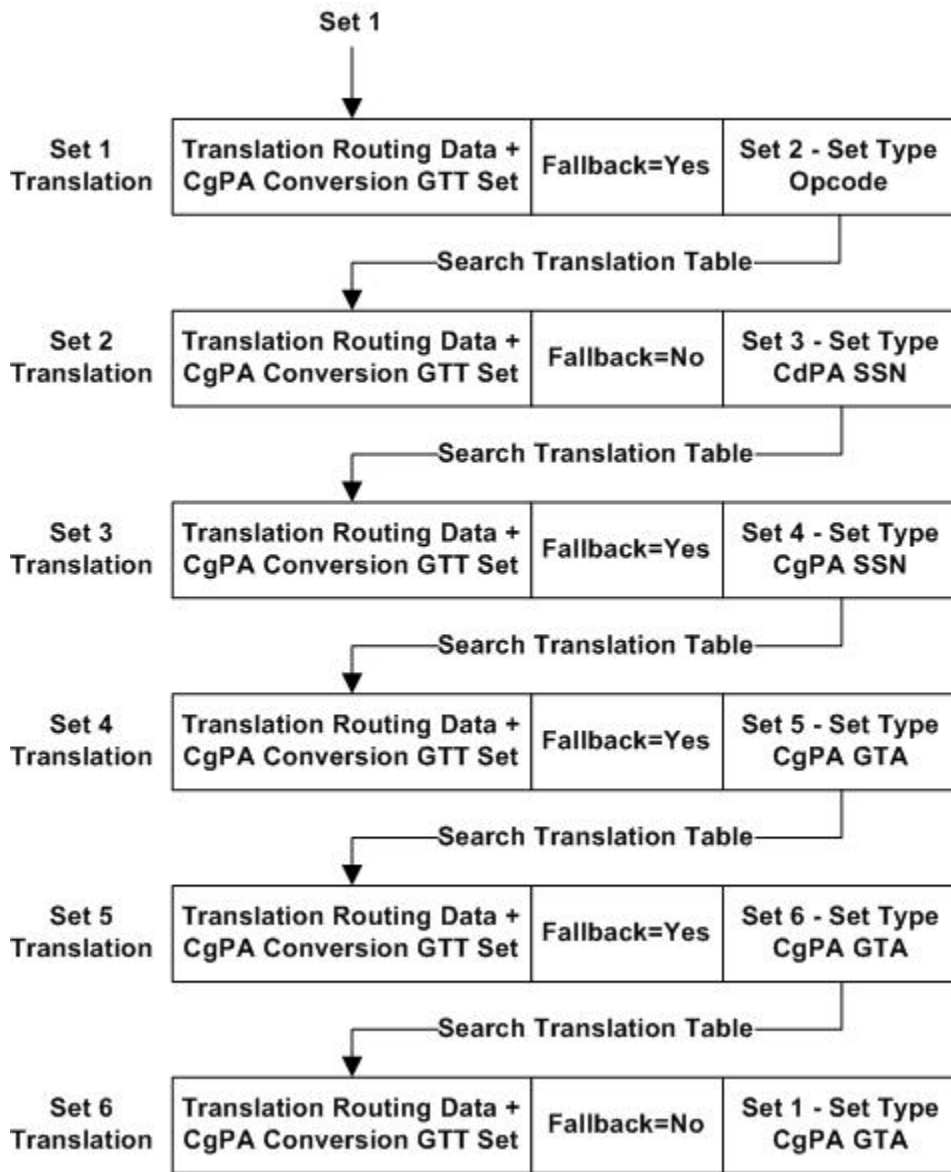

In [Figure 2-8](#), even if the Set 5 Translation contains the Set 6 GTT set (Set 5 and Set 6 are that same type of GTT sets), the Set 6 Translation will be searched for the matching translation. If the Set 6 Translation contains the Set 1 GTT set and since Set 1 has already searched, the Set 1 translation is not searched again and the fallback option of the last matched translation is examined. Since the last matched translation is found in Set 6 and the fallback option is set to No, the MSU is discarded. UIM 1413 - GTT(FLOBR) failure: duplicate set name is generated to describe the condition. In [Figure 2-8](#), if the Set 6 Translation was not found and since the fallback option in the Set 5 Translation is set to Yes, the MSU is routed based on the data in the Set 5 Translation.

Limiting the Number of Database Searches for the Flexible Linkset Optional Based Routing Feature

The number of database searches is limited to seven when the Flexible Linkset Optional Based Routing feature is enabled and turned on. This includes searching the GTT selector table when a translation contains the CgPA SELID or CdPA SELID parameter.

Figure 2-9 Limit the Number of Database Searches

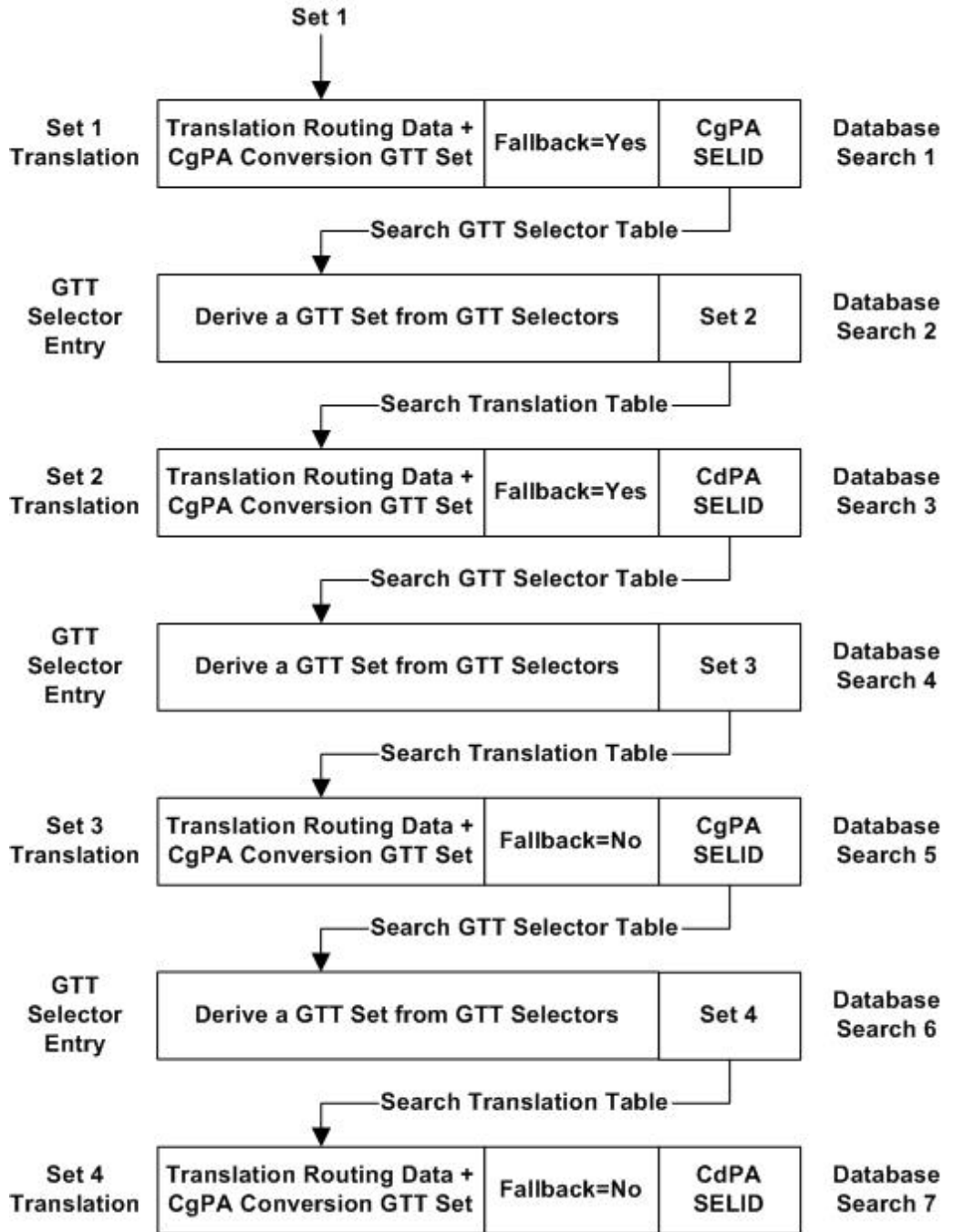

As shown in Figure 2-9, when a translation contains the CdPA SELID or CgPA SELID, the search in the GTT selector table is also counted toward the maximum seven searches. After completing seven searches, if the search is terminated because of

the maximum seven search criteria, the action defined in the last matched Set 4 Translation fallback option (in this case No) is performed and MSU is discarded. UIM 1412 - GTT (FLOBR) failure: max search depth is generated to describe the condition. After completing seven searches, if the last matched translation contains no GTT set/SELID data (if the CdPA SELID data is not provisioned in the Set 4 Translation), the MSU is routed based on the routing data in the Set 4 Translation. The first GTT selector search when the GTT functionality is selected (deriving Set 1 in [Figure 2-9](#)) is not counted toward the maximum seven search criteria.

Limiting the Number of GTT Set Searches for the Flexible Linkset Optional Based Routing Feature

The number of GTT set searches is limited to seven when the Flexible Linkset Optional Based Routing feature is enabled and turned on.

Figure 2-10 Limit the Number of GTT Set Searches

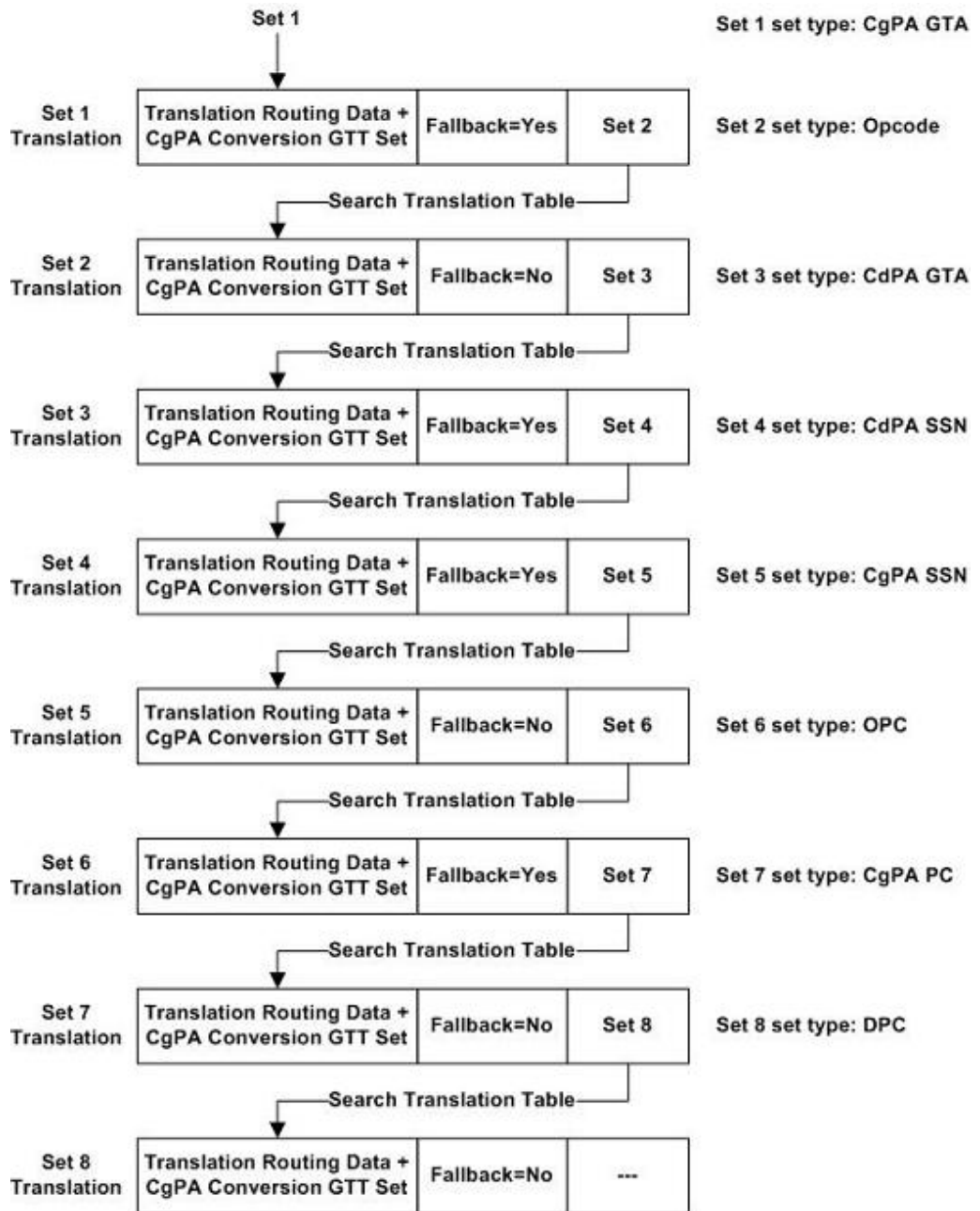

As shown in Figure 2-10, after completing seven GTT set searches, if the search is terminated because of the maximum of seven searches have been performed, the action defined by the fallback option in Set 7 Translation, in this case No, is performed and the MSU is discarded. UIM 1412 - GTT(FLOBR) failure: max search depth is generated to describe the condition. If the Set 7 Translation contains no GTT sets, Set 8 is this case, the MSU is routed based on the routing data in the Set 7 Translation.

GTT for MSUs Generated by the EAGLE

The EAGLE performs global title translation on some messages generated by itself. These messages are sent in response to queries received by local subsystems. SCCP UDTs and XUDTs messages also fall under this category. Global title translation is performed to find the destination for the responses when the SCCP calling party address in query messages is Route-on-GT. Since there is no valid incoming link set for messages generated by the EAGLE, a special set of GTT selector entries are used when the Flexible Linkset Optional Based Routing feature is enabled and turned on. The `eaglegen=yes` parameter in the `ent-/dlt-/chg-/rtrv-gttset` commands is used to provision a GTT selector for messages generated by the EAGLE. If the `eaglegen=no` parameter is specified for a GTT selector, the GTT selector is not provisioned for messages generated by the EAGLE.

When the `eaglegen=yes` parameter is specified for a GTT selector,

- Any CgPA related parameters, the linkset name, and SELID parameters cannot be specified.
- The Flexible Linkset Optional Based Routing feature must be enabled and turned on.
- A GTT set with the CdPA GTA set type must be specified.
- A dummy link set name `Eagle-Gen` is displayed in the `rtrv-gttset` command output.

If the GTT set name assigned to a GTT selector for messages generated by the EAGLE is changed with the `chg-gttset` command, the new GTT set must be a CdPA GTT set.

If no match is found in the GTT selector entries that contain the `eaglegen=yes` parameter, the entries with LSN value ANY are searched. If a matching entry is still not found, for GTI=4 entries, the GTT set with CdPA set type for NP and NAI values Default are returned. For GTI=2 entries, a match not found message is returned. The Flexible Linkset Optional Based Routing feature hierarchies do not apply for GTT selectors provisioned for messages generated by the EAGLE and the CDPA Only GTT mode is used for such translations.

GTT Selector Key

Table 2-11 defines the keys into GTT selector table based on the feature combination. If a feature supports specific parameters and that feature is not enabled or turned, if necessary, then default values for these parameters are entered into the database.

Table 2-11 GTT Selector Key

Feature Combination	Selector Type	GTI, Domain, TT, (NP and NAI if the GTII/GTIN/GTIN24=4)	CgPA SSN	SELID	Linkset Name
EGTT	CdPA Only	X	-	X (See Note 1)	-
Origin-Based SCCP Routing	CdPA	X	-	X (See Note 1)	-
	CgPA	X	X	X	-
Flexible Linkset Optional	CdPA	X	-	X	X

Table 2-11 (Cont.) GTT Selector Key

Feature Combination	Selector Type	GTI, Domain, TT, (NP and NAI if the GTII/GTIN/GTIN24=4)	CgPA SSN	SELID	Linkset Name
Based Routing	CgPA	X	-	X	X
Origin-Based SCCP Routing and Flexible Linkset Optional Based Routing	CdPA CgPA	X X	- X	X X	X X
Messages generated by the EAGLE	CdPA only	X	-	-	X (See Note 2)

 **Note:**

1. This is applicable only for service relayed MSUS whose GTT Required value is on and the GTT selector ID is not equal to none in the service selector entry.
2. See the [GTT for MSUs Generated by the EAGLE](#) section.

Searching Order in the GTT Selector Table with the Flexible Linkset Optional Based Routing Feature

The searching order for CgPA and CdPA GTT selectors when the Flexible Linkset Optional Based Routing feature is enabled and turned on are shown in these tables.

- [Table 2-12](#)
- [Table 2-13](#)
- [Table 2-10](#)

Table 2-12 CdPA GTT Selector Keys

Priority	GTI, Domain, TT, (NP and NAI if the GTII/GTIN/GTIN24=4)	Linkset Name	SELID	CdPA GTT Selector Found or Not Found
1	Exact	Exact	Exact	If a CdPA GTT set is provisioned for the GTT selector keys, the GTT selector is considered found. Otherwise, the GTT

Table 2-12 (Cont.) CdPA GTT Selector Keys

Priority	GTI, Domain, TT, (NP and NAI if the GTII/GTIN/GTIN24=4)	Linkset Name	SELID	CdPA GTT Selector Found or Not Found
2	Exact	Any	Exact	selector is not found. See the Note.

Note: If an Origin-Based SCCP Routing GTT hierarchy is being used, the CdPA GTT set must be a CDGTA GTT set and the CgPA GTT set must be either a CGGTA or CGPC GTT set. If a Flexible Linkset Optional Based Routing feature GTT hierarchy is being used, any GTT set type can be used.

Table 2-13 CgPA GTT Selector Keys

Priority	GTI, Domain, TT, (NP and NAI if the GTII/GTIN/GTIN24=4)	Linkset Name	SELID	CgPA SSN	CgPA GTT Selector Found or Not Found
1	Exact	Exact	Exact	Exact	If a CgPA GTT set is provisioned for the GTT selector keys, the GTT selector is considered found. Otherwise, the GTT selector is not found. See the Note.
2	Exact	Exact	Exact	Any	
3	Exact	Any	Exact	Exact	
4	Exact	Any	Exact	Any	

Note: If an Origin-Based SCCP Routing GTT hierarchy is being used, the CdPA GTT set must be a CDGTA GTT set and the CgPA GTT set must be either a CGGTA or CGPC GTT set. If a Flexible Linkset Optional Based Routing feature GTT hierarchy is being used, any GTT set type can be used.

Table 2-14 Messages Generated by the EAGLE GTT Selector Keys

Priority	GTI, Domain, TT, (NP and NAI if the GTII/GTIN/GTIN24=4)	Linkset Name	Messages Generated by the EAGLE GTT Selector Found or Not Found
1	Exact	Eagle=Gen	If a CdPA GTT set with the CDGTA GTT set type is provisioned for the GTT selector keys, the GTT selector is considered found. Otherwise, the GTT selector is not found. See the Note.
2	Exact	Any	
3	For GTI=4, the GTT set with the values Default for the NP and NAI parameters.	Any	

Note: If an Origin-Based SCCP Routing GTT hierarchy is being used, the CdPA GTT set must be a CDGTA GTT set and the CgPA GTT set must be either a CGGTA or CGPC GTT set. If a Flexible Linkset Optional Based Routing feature GTT hierarchy is being used, any GTT set type can be used.

Hardware Requirements

To enable the Flexible Linkset Optional Based Routing feature DSM or SLIC cards must be provisioned in the database. Any Legacy Cards must be replaced.

Provisioning the Flexible Linkset Optional Based Routing Feature

To provision the Flexible Linkset Optional Based Routing feature, perform these steps.

1. Turn the GTT and EGTT features on using the `chg-feat` command. Add the required DSM or SLIC cards to the database using the `ent-card` command. Perform [Adding a Service Module](#).
2. Enable and turn on the Flexible Linkset Optional Based Routing feature using the `enable-ctrl-feat` and the `chg-ctrl-feat` commands. Perform [Activating the Flexible Linkset Optional Based Routing Feature](#).
3. Provision the required GTT sets using the `ent-gttset` command. Perform [Adding a GTT Set](#).
4. Provision the required GTT translations using the `ent-gta` command. Perform [Adding Global Title Address Information](#).
5. Provision the required GTT selectors using the `ent-gttset` command. Perform [Adding a GTT Selector](#).
6. Change the default fallback option, if desired, using the `chg-sccpopts` command. Perform [Changing the Default GTT Mode Options](#).

TCAP Opcode Based Routing

TCAP Opcode Based Routing allows the EAGLE to route messages based on their operation codes. When the TCAP Opcode Based Routing feature is enabled and turned on, this information contained in the TCAP portion of messages is used for performing global title translation. TOBR is also able to process Segmented XUDT(S) message.

- To perform global title translation on ITU messages:
 - Message Type / Package Type
 - Application Context Name
 - Operation Code
- To perform global title translation on ANSI messages:
 - Package Type
 - Operation Code Family
 - Operation Code Specifier

TCAP Opcode Based Routing requires that the Flexible Linkset Optional Based Routing feature is enabled and turned on. TCAP Opcode Based Routing can be used with or without the Origin-Based SCCP Routing feature. [Table 2-7](#) shows the type of GTT sets that can be provisioned for GTT selectors based on the features that are enabled and turned on.

TCAP Decoding

As part of the TCAP Opcode Based Routing feature, the EAGLE attempts to decode TCAP portion of all UDT/UDTS/XUDT/XUDTS queries coming to service modules

for global title translation. Messages are decoded only if a TOBR Opcode Quantity is enabled. The objective of this decoder is not to validate the correctness of the message but simply to obtain the required TCAP data. The message is validated only for the encoding rules that are required to successfully decode the required TCAP information. In general, Tag-Length-Value encoding is validated; unsupported Tag values are skipped if they are encountered, unless a specific Tag order is expected. If the decoding fails, global title translation is still performed on the message using some default values for the TCAP data that denote their absence in the message. The TCAP Opcode Based Routing feature supports the following messages.

- ITU TCAP Message/Package Types:
 - Begin
 - Continue
 - End
 - Abort
 - Unidirectional
- ANSI TCAP Message/Package Types:
 - Unidirectional
 - Query With Permission
 - Query Without Permission
 - Response
 - Conversation With Permission
 - Conversation Without Permission
 - Abort

Other message/package types are treated as an unknown message type and are not proceed with the decoding. This is not considered an error, because many non-TCAP SCCP messages are processed by the EAGLE. For these messages, the TCAP data is not used for routing. If an opcode translation set is encountered while performing global title translation, the opcode translation set is considered as a “translation not found” in that set. Such messages are routed based on last matched translation depending on its fallback option. Refer to [Flexible Linkset Optional Based Routing](#) for more details on the fallback option.

The application context name (ACN) is used for all supported ITU TCAP messages except Abort messages. No attempt to retrieve the ACN is made for Abort messages. All other supported messages may have a Dialog portion containing Dialogue Request / Unidirectional Dialogue / Dialogue Response PDU, from which the ACN is retrieved. If no Dialog portion is detected, then the ACN is assumed to be NONE. The TCAP Opcode Based Routing feature attempts to find the operation code (opcode) in all supported ITU TCAP messages except Abort. These messages must contain Invoke or Return Result (Last or Not Last) as the first component. If not, the opcode is assumed to be NONE.

The TCAP Opcode Based Routing feature attempts to find the Operation Family and Specifier in all supported ANSI TCAP messages (except Abort) containing an INVOKE component. For all other messages, the Family and Opcode values are assumed to be NONE. Unless otherwise specified, the TCAP length fields are validated because all formats of the TCAP lengths (short, long, and indefinite) are supported for ITU TCAP messages. Indefinite form of lengths are not supported for ANSI TCAP messages.

However, the primitive elements in ITU or ANSI TCAP messages are allowed to have long format or indefinite lengths. In the long format, the TCAP Opcode Based Routing feature does not allow a field length of more than two bytes. This limitation is considered acceptable because:

- The SCCP data portion for UDT(S)/XUDT(S) messages is a 1-byte length field. It has a maximum value of 255 bytes.
- All TCAP lengths of 255 bytes or less can be encoded with a 2-byte length field.

At any point of time during the decoding process, if it is found that the current position in TCAP message is extending beyond the SCCP data portion length, the decoder process stops.

TCAP Opcode Based Routing GTT Sets

The TCAP Opcode Based Routing feature introduces the GTT Set Opcode with set type `opcode`. The opcode GTT set supports translations for ANSI and ITU opcodes.

TOBR Opcode Quantities

To provision a TCAP Opcode Based Routing entry for global title translation, a TOBR opcode quantity must be enabled with the `enable-ctrl-feat` command. These are the quantities that can be enabled:

- 3 opcode translations (part number : 893027901)
- 6 opcode translations (part number : 893027902)
- 12 opcode translations (part number : 893027903)
- 24 opcode translations (part number : 893027904)
- 48 opcode translations (part number : 893027905)
- 96 opcode translations (part number : 893027906)
- 1 million opcode translations (part number : 893027907) - the GTT translation table capacity is controlled by the XGTT Table Expansion feature.

MAP Based Routing

The following GTT settypes are introduced with the SS7 Firewall Feature:

- IMEI
- IMSI
- MSISDN
- VLRNb
- SMRPOA
- SMRPDA

These GTT settypes allow additional MAP Components to be used in the selection process. These GTT settypes are allowed to be provisioned ONLY in GTA entries from an OPCODE GTT Set type or one of the other GTT settypes supported by SS7 Firewall feature.

Additional opcodes supported by MAP Based Routing include:

- PurgeMS
- RestoreData

- Reset
- RegisterSS
- USSD-Request
- USSD-Notify
- SnedAuthenticationInfo
- CheckIMEI
- Provide Subscriber Location
- SubscriberLocationReport
- UpdateGPRSLocation

When an MSU is processed by the TOBR GTT translation with the OPTSN as one of MAP Based Routing settypes, the EAGLE decodes the TCAP part and extracts the required TCAP parameter from the MSU. The digits in this parameter are used as the key to search for the translation in the GTT set.

Only TCAP Package Types BEGIN, CONTINUE & END are supported for MAP Based Routing. OPTSN with one of the MAP Based Routing GTT settypes are allowed to be provisioned only for TOBR GTA entries that have PKGTYPE as BGN, or CNT or END.

If the parameter contains NP and NoN, they are not part of the key; the key is the digits only, as it is in SCCP CdPA and CgPA GTT Sets. The lookup in these GTT Sets follow the CdPA and CgPA GTT Set rules, however, the following rules are unique to MAP Based Routing GTT Sets:

- If the component parameter is not present in the MSU, the user will be able to provision an alternate GTT Set which looks at another TCAP parameter. In the `ent/chg-gttset` commands, a new parameter NPSN (Not Present Set Name) is used to allow provisioning of this alternate GTT Set.

 **Note:**

The alternate GTT Set will only be used if the MAP parameter is optional and not present in the MSU. If the MAP parameter is mandatory for that opcode or was present but the lookup failed, the NPSN GTT Set will not be used.

- The NPSN depth search is not part of the FLOBR depth search

For some MAP operations, it is possible for IMSI/MSISDN to be present in the Destination Reference of the dialogue portion; however, currently this feature only supports decoding the key from only the component portion of the TCAP part. If the required parameter is not present in the component portion, the parameter will be deemed 'not present' even though it is in the dialogue portion.

The following method is used to determine the MAP version:

1. If the Dialogue Portion is present in the message, pick the last byte of the ACN. MAP Based Routing is only decoding the last byte of the ACN to determine the MAP version, not validating whether the MAP operation is supported with the ACN in the message.
2. If the Dialogue Portion is not present, the MAP version provisioned with the Opcode translation will be used as the MAP version.

If the Dialogue Portion is present but the ACN could not be decoded, then the default version will be picked up from the `defmapvr` parameter for further processing. `defmapvr` is configured in opcode translation and used for opcodes that have MAP translations associated with it.

Figure 2-11 MAP Based Routing Flowchart

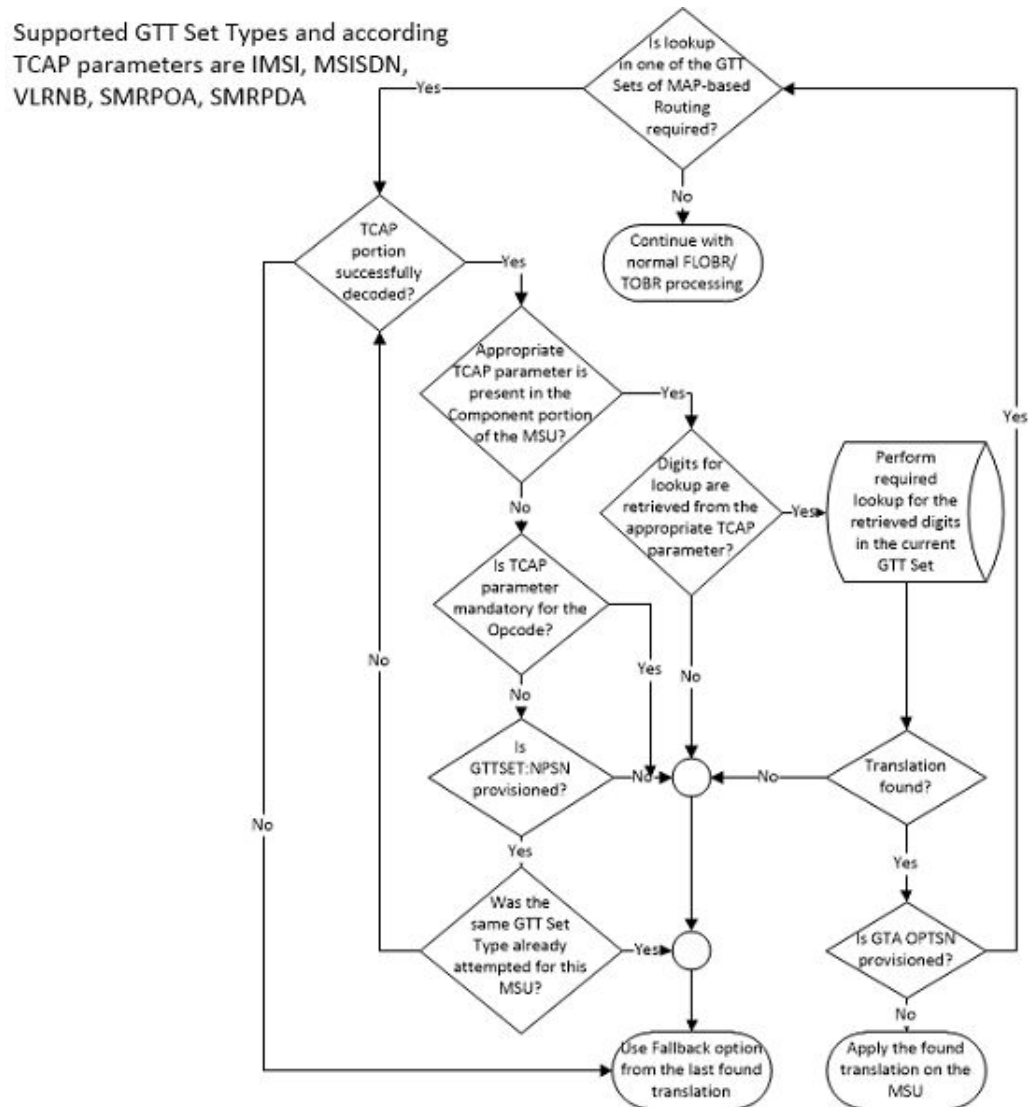

GTT Translations

The GTT translations provisioned for the TCAP Opcode Based Routing feature can also be provisioned for these features:

- Advanced GT Modification
- Variable Length Global Title Translation
- SCCP Loop Detection
- Intermediate GTT Load Sharing

- ANSI/ITU SCCP Conversion
- Flexible GTT Load Sharing

TCAP Opcode Based Routing Feature Translations with an ANSI Opcode

The key for ANSI opcode translations is the ANSI opcode specifier, the ANSI TCAP Package Type, and the Family (part of ANSI TCAP opcode field). The ANSI opcode specifier values can be 0 to 255, None, and * (any opcode specifier value). The value none indicates the absence of the opcode in the incoming MSU. The ANSI TCAP Package Type values are Unidirectional, Query with Permission, Query without Permission, Response, Conversation with Permission, Conversation without Permission, Abort, and Any. The Family value can be 0 to 255, None, and * (any family value). While provisioning, when ANSI TCAP Package type is specified as Abort, then the ANSI opcode specifier and Family values must be none. Since the opcode specifier and family values exist together in the incoming MSU, both values in the translation must be none if either value is specified as none.

Search Order for the TCAP Opcode Based Routing Feature Translations with an ANSI Opcode

[Table 2-15](#) shows the searching order for The TCAP Opcode Based Routing feature translations with an ANSI opcode. The ANSI opcode translations are matched to ANSI MSUs:

Table 2-15 Search Order for the TCAP Opcode Based Routing Feature Translations with an ANSI Opcode

Priority	TCAP Package Type	ANSI Opcode	Family
1	Exact (package type value)	Exact (the value none or a number)	Exact (the value none or a number)
2	Exact	Exact	Any
3	Exact	Any	Exact
4	Exact	Any	Any
5	Any	Exact	Exact
6	Any	Exact	Any
7	Any	Any	Exact
8	Any	Any	Any

TCAP Opcode Based Routing Feature Translations with an ITU Opcode

The key for ITU opcode translations is the ITU opcode, the ITU TCAP Package Type, and the application context name (ACN). The ITU opcode values can be 0 to 255, None, and * (any opcode value). The value none indicates the absence of the opcode in the incoming MSU. The ITU TCAP Package Type values are Begin, End, Continue, Abort, Unidirectional, and Any. The ACN value can be 1 to 7 bytes - the value of each byte is from 0 to 255, none and Any. The none value indicates the absence of the ACN value in the incoming MSU. Though the VGTT feature is not supported for opcode GTT set, different digit length ACNs for the opcode GTT set can be provisioned. While provisioning, when ITU TCAP Package type is specified as Abort, then the ITU opcode and ACN values must be none. An ACN value cannot contain a mixture numbers, the value none, or the value Any. [Table 2-16](#) shows the valid and invalid values for the ACN.

Table 2-16 Valid and Invalid ACN Values

ACN Value	Does The TCAP Opcode Based Routing Feature Support this ACN?	Information
Bytes 1-2-3-4-5	Yes	The remaining bytes are treated as None.
Bytes 1-2-3-4-5-6-7	Yes	
Byte 1	Yes	The remaining bytes are treated as None.
None	Yes	All the bytes are treated as None.
Any	Yes	All the bytes are treated as Any.
Byte 1-none-Byte 2	No	
Byte 1-any-Byte 3-Byte4	No	
Any-Byte1	No	
None-Any-Byte1	No	

Search Order for the TCAP Opcode Based Routing Feature Translations with an ITU Opcode

Table 2-17 shows the search order for the TCAP Opcode Based Routing feature translations with an ITU opcode when the TCAP Opcode Based Routing feature is enabled and turned on. The ITU opcode translations are only matched to ITU MSUs. If any MSU contains a 7-byte ACN value, an attempt is made to match the 7-byte ACN values with the values in the database. If a match is not found, no attempt is made to match any 6-/5-/4-/3-/2-/1-byte ACN values in the database. An attempt is made to match to any ACN=ANY entries in the database, if these entries are provisioned in the database.

Table 2-17 Search Order for the TCAP Opcode Based Routing Feature Translations with an ITU Opcode

Priority	TCAP Package Type	ANSI Opcode	ACN
1	Exact (package type value)	Exact (the value none or a number)	Exact (the value none or a number)
2	Exact	Exact	Any
3	Exact	Any	Exact
4	Exact	Any	Any
5	Any	Exact	Exact
6	Any	Exact	Any
7	Any	Any	Exact
8	Any	Any	Any

TCAP Segmentation SMS Support Phase 2

An objective of the TCAP Opcode Based Routing feature is to allow EAGLE to route segmented TCAP SMS messages in the same manner as non-segmented TCAP messages are routed. This would mean routing all TCAP SMS messages within a particular transaction to the same place. Routing rules based on the opcode are used

to route messages for special application handling. These rules work well for non-segmented TCAP messages. However they do not work well for segmented TCAP messages, because the initial BEGIN message does not contain an opcode. These messages must be identified for special routing based on other criteria. The TCAP Opcode Based Routing feature achieves this discrimination by allowing the EAGLE to route messages based on the TCAP Opcode and Dialogue portion information in the message. The EAGLE uses the Application Context Name from the Dialogue portion to route the TCAP Begin messages without the component portion (and without the operation code). The same routing rules to route messages with an ACN and opcode, an ACN only, or an opcode only value can be used. GSM SMS messages work particularly well in this solution, because there is a 1 to 1 correspondence between the ACN and opcode values.

Hardware Requirements

To enable the TCAP Opcode Based Routing feature E5-SM4G cards must be provisioned in the database. Any SMs must be replaced by the E5-SM4G cards.

Provisioning the TCAP Opcode Based Routing Feature

To provision the TCAP Opcode Based Routing feature, perform these steps.

1. Turn the GTT and EGTT features on using the `chg-feat` command. Add the required E5-SM4G cards to the database using the `ent-card` command. Perform the [Adding a Service Module](#) procedure.
2. Enable and turn on the TCAP Opcode Based Routing feature using the `enable-ctrl-feat` and the `chg-ctrl-feat` commands. Perform the [Activating the TCAP Opcode Based Routing Feature](#) procedure. To enable and turn on the TCAP Opcode Based Routing feature, the Flexible Linkset Optional Based Routing feature must be enabled and turned on. The status of the Flexible Linkset Optional Based Routing feature is verified when the [Activating the TCAP Opcode Based Routing Feature](#) procedure is performed.
3. Enable a TOBR Opcode Quantity using the `enable-ctrl-feat` command. Perform the [Enabling a TOBR Opcode Quantity](#) procedure.
4. Provision the required GTT sets using the `ent-gttset` command. Perform the [Adding a GTT Set](#) procedure.
5. Provision the required GTT translations using the `ent-gta` command. Perform the [Adding Global Title Address Information](#) procedure.
6. Provision the required GTT selectors using the `ent-gttsel` command. Perform the [Adding a GTT Selector](#) procedure.

GTT Actions

The GTT Actions allows these actions to be applied to MSUs during global title translation message processing:

- Discard
- UDTs
- Duplicate
- TCAP error
- Forward

- Services
- SFLOG
- SFTHROT
- SCPVAL
- SFAPP

 **Note:**

GTT Actions SFTHROT and SFLOG are not supported on GTT-enabled IPSP cards in Release 46.5.

A GTT action entry contains one GTT action, a GTT action ID, data specific to the action, and a reference count. These actions are contained in a GTT action entry. The EAGLE contain a maximum of 2000 GTT action entries. A GTT action entry, identified by the GTT action ID, is assigned to a GTT action set. The GTT action set is assigned to the global title address entry. The reference count in the GTT action entry shows the number of database entities GTT action sets that reference the GTT action entry. When a GTT action entry is referenced by a GTT action set, a service selector ID, or a Forward GTT action entry, or an LNP service, the reference count is increased by 1. When a GTT action set, a service selector ID, or a Forward GTT action entry, or an LNP service no longer references the GTT action entry, the reference count is decreased by 1. The GTT action entry can be removed only when the reference count is zero. The data for each GTT action entry is shown in the `rtrv-gttact` output.

Discard GTT Action

The Discard GTT action discards the MSU. A Discard GTT action entry is provisioned with the `ent-gttact` command using these parameters.

- `actid` - the GTT action ID
- `act=disc` - the discard GTT action
- `on=uimreqd` - UIM 1193 GTT Action DISCARD DISCARDED MSU is generated when the MSU is discarded.
- `off=uimreqd` - UIM 1193 GTT Action DISCARD DISCARDED MSU is not generated when the MSU is discarded.

 **Note:**

If neither the `on=uimreqd` or `off=uimreqd` parameters are specified, the `UIMREQD` value defaults to `off`.

An example of the Discard GTT action entry is shown in [Figure 2-12](#).

Figure 2-12 Discard GTT Action Entry

GTT Action Id	GTT Action	Action specific data		Reference Count
		Display UIM after discard Action?		
ACTID1	Discard	YES		10

UDTS GTT Action

The UDTS GTT action discards the MSU with the UDTS error code that is provisioned for the GTT action entry which specifies the reason associated with the UDTS GTT action for discarding the message. A UDTS GTT action entry is provisioned with the `ent-gttact` command using these parameters.

- `actid` - the GTT action ID
- `act=udts` - the UDTS GTT action
- `udtserr= 0 to 255`
- `on=uimreqd` - UIM 1192 GTT Action UDTS DISCARDED MSU is generated when the MSU is discarded.
- `off=uimreqd` - UIM 1192 GTT Action UDTS DISCARDED MSU is not generated when the MSU is discarded.

 **Note:**

If neither the `on=uimreqd` or `off=uimreqd` parameters are specified, the `UIMREQD` value defaults to `off`.

An example of the UDTS GTT action entry is shown in [Figure 2-13](#).

Figure 2-13 UDTS GTT Action Entry

GTT Action Id	GTT Action	Action specific data		Reference Count
		UDTS Error Code	Display UIM after UDTS Action?	
ACTID2	UDTS	10	NO	20

TCAP Error GTT Action

The TCAP Error GTT action discards the MSU and a reject message is sent to the originator of the MSU with either an ANSI TCAP error code or an ITU TCAP error code that is provisioned for the GTT action entry. A TCAP Error GTT action entry is provisioned with the `ent-gttact` command using these parameters.

- `actid` - the GTT action ID
- `act=tcaperr` - the TCAP Error GTT action
- `atcaperr= 0 to 255` - the ANSI TCAP error code
- `itcaperr= 0 to 255` - the ITU TCAP error code
- `on=uimreqd` - UIM 1077 GTT Action TCAP ERROR DISCARDED MSU is generated when the MSU is discarded.
- `off=uimreqd` - UIM 1077 GTT Action TCAP ERROR DISCARDED MSU is not generated when the MSU is discarded.

 **Note:**

If neither the `on=uimreqd` or `off=uimreqd` parameters are specified, the `UIMREQD` value defaults to `off`.

An example of the TCAP Error GTT action entry is shown in [Figure 2-14](#).

Figure 2-14 TCAP Error GTT Action Entry

GTT Action Id	GTT Action	Action specific data			Reference Count
		ANSI TCAP Error Code	ITU TCAP Error Code	Display UIM after TCAP Error Action?	
ACTID3	TCAP Error	1	2	YES	30

Duplicate GTT Action

The Duplicate GTT action sends a copy of the MSU to the duplicate node. The Duplicate GTT action is in addition to the normal processing and routing of the translated MSU. The translated MSU is not modified with any of the Duplicate GTT action data. If the Duplicate GTT action fails, UIM 1078 GTT Action DUPLICATE FAILED is generated. A Duplicate GTT action entry is provisioned with the `ent-gttact` command using these parameters.

- `actid` - the GTT action ID
- `act=dup` - the Duplicate GTT action
- `pc/pca/pci/pcn/pcn24`=the point code of the duplicate node
- `ri=<gt, ssn>` - the routing indicator in the SCCP called party address of the duplicated copy of MSU.
- `mrnset=<1 - 3000 or none>` - the MRN set ID, shown in the `rtrv-mrn` output, or no MRN set ID
- `mapset=<1 - 36000 or dflt>` - The MAP set ID or the default MAP set ID, shown in the `rtrv-map` output
- `ssn=<2 - 255>` - The subsystem number in the SCCP called party address of the duplicated copy of MSU.

- `loopset` - the name of the loopset, shown in the `rtrv-loopset` output, associated with the Duplicate GTT action entry
- `cggtmodid` - the calling party global title modification identifier, shown in the `rtrv-gtmod` output, associated with the calling party of a GTT action entry.
- `cdgtmodid` - the called party global title modification identifier, shown in the `rtrv-gtmod` output, associated with the called party of a GTT action entry.
- `cgpc/cgpca/cgpci/cgpcn/cgpcn24` - the calling party point code in the outgoing message when the `cgpcogmsg` parameter value is `provcgpc`. The network type of the `cgpc/cgpca/cgpci/cgpcn/cgpcn24` value must be the same as the `pc/pca/pci/pcn/pcn24` value.
- `cgpcogmsg=<dfllt, cgpcicmsg, opcicmsg, provcgpc>` - the data that is used as the calling party point code in the outgoing message.
 - `dfllt` - default. The standard Global Title Translation process supplies the calling party address point code.

 **Note:**

If the `cgpc/cgpca/cgpci/cgpcn/cgpcn24` and the `cgpcogmsg` parameters are not specified, the default value for the `cgpcogmsg` parameter is `dfllt`.

- `cgpcicmsg` - the calling party address point code data from the incoming MSU
- `opcicmsg` - the OPC data from the incoming MSU
- `provcgpc` - the `cgpc/cgpca/cgpci/cgpcn/cgpcn24` value provisioned in the Duplicate GTT Action.
- `on=useicmsg` - The incoming MSU is duplicated to the MSU. The incoming MSU is the MSU before applying the translation data by any EPAP service or global title translation process and before applying the GTT actions data. However, it is possible that some data in the MSU may have been modified by the LIM before arriving on the service module. The TCAP layer may have been modified by any EPAP service.
- `off=useicmsg` - The translated MSU is duplicated to the MSU. The translated MSU is the MSU after applying the translation data by any EPAP/ELAP service or global title translation process and before applying the GTT actions data. However, it is possible that some data in the MSU may have been modified by the LIM before arriving on the service module. The TCAP layer may have been modified by any EPAP service.

 **Note:**

If neither the `on=useicmsg` or `off=useicmsg` parameters are specified, the `USEICMSG` value defaults to `off`.

An example of the Duplicate GTT action entry is shown in [Figure 2-15](#).

Figure 2-15 Duplicate GTT Action Entry

GTT Action Id	GTT Action	Action specific data										Reference Count
		Routing Indicator	PCA/PCI/PCN/PCN24	SSN	MRN/ MAP SET ID	Use Incoming MSU?	CG PC in Duplicated MSU	CG PCA /PC/PCN /PCN24	CgPA GTMOD ID	CgPA GTMOD ID	Loop Set Name	
ACTID4	Duplicate	SSN	2-2-2	5	25	YES	Default CgPA PC in incoming MSU OR OPC in incoming MSU OR Provisioned CG PC	OR 1-5-230 OR	GTM1	GTM2	LP51	40

During message processing, these actions are performed based on the `cgpcogmsg` parameter value in the Duplicate GTT action entry,

- The CgPA point code field in the duplicated MSU is updated.
- If the CgPA point code field is not present in the duplicated MSU, the OPC field is updated with the `cgpcogmsg` parameter value in the Duplicate GTT action entry.
- If a value other than `df1t` for `cgpcogmsg` parameter value in the Duplicate GTT action entry and the CgPA point code or the OPC is not present or cannot be used in the MSU, The EAGLE uses the `df1t` value of the `cgpcogmsg` parameter; the CgPA point code supplied by standard global title translation process is applied.

Forward GTT Action

The Forward GTT action diverts the translated MSU to another node. If the EAGLE fails to forward the MSU, UIM 1079 GTT Action FORWARD FAILED is generated.

An example of the Forwarded GTT action entry is shown in [Figure 2-16](#).

Figure 2-16 Forward GTT Action Entry

GTT Action ID	GTT Action	Action Specific Data										Reference Count	
		Routing Indicator	PCA/PCI/PCN/PCN24	SSN	MRN/ MAP Set ID	Use Incoming MSU?	CG PC in forwarded MSU	CG PCA /PC/PCN/ PCN24	CgPA GTMOD ID	CgPA GTMOD ID	Loop Set Name		Default Action
ACTID5	Forward	GT	3-3-3	-	15	Yes	Default CgPA PC in incoming MSU OR OPC in incoming MSU OR Provisioned CG PC	OR 3-6-7 OR	GTM4	GTM8	LP55	Any discard GTT Action or Fallback	50

The Forward GTT Action entry uses the same parameters and values that is used in the Duplicate GTT Action entry, along with the default action (`defactid`) parameter. The `defactid` parameter indicates what action is taken when the EAGLE fails to route the forwarded MSU. These are the default actions are:

- Discard GTT action entry ID - perform the action defined by the Discard GTT entry ID.
- UDTS GTT Action ID - perform the action defined by the UDTS GTT action entry ID.
- TCAP Error GTT Action ID - perform the action defined by the TCAP Error GTT action entry ID.
- Fallback to the translated MSU (`fallback`). The translated MSU is routed according to the routing data in the translated MSU. The routing data can be from an EPAP service or the PPSOPTS table, or the global title translation process. Fallback to the translated MSU is the default value for the `defactid` parameter if the `defactid` parameter is not specified.

Services GTT Action

GTT Action Services allow triggering a Service as a GTT action either based on the usual GTT rules or after FLOBR/TOBR execution.

An example of the Services GTT action entry is shown in [Figure 2-17](#).

Figure 2-17 Services GTT Action Entry

GTT Action Id	GTT Action	Action specific data				Reference Count
		SRVCNAME	SRVCERR	SNP	SNAI	
ACTID3	SRVC	GFLEX	SRVC	E164	SUB	30

Any of these three Services can be applied on the translated MSU -**GPORT**, **GFLEX** or **SMSMR**. The new GTT Actions Service cannot be applied on MTP routed MSUs.

GTT Action Services can work with the RTDB Split Feature (240M DN and 240M IMSIs via split database). This compatibility is possible only when GTT Action is executed on GTT enabled LIM cards.

The GTT Action SERVICE features the following options:

- GTT Action ID
- GTT Action - SRVC
- SRVCNAME - Service name applied on the translated MSU
- SNP - Service Numbering Plan of the service applied
- SNAI - Service nature of the address indicator of the service applied
- SRVCERR - GTT/SRV

If the Service is triggered by the GTT Action Service fails, the MSU can be processed by applying the results of the pre-Service GTT or processing with the specific Service error.

SFTHROT GTT Action

The SFTHROT GTT Action is used to control the throttling of MSUs on SCCP cards. Thirty-two (32) GTT actions of the type SFTHROT will be allowed. For each such GTT action, the user will provision a threshold as a maximum number of MSUs hitting the GTT action in a 30-second period.

When an MSU hits a GTT action of the type SFTHROT, the SCCP card updates the count of messages that hit the Throttling GTT action and periodically communicates the count to the OAM card via maintenance blocks. The OAM sums the total number of these messages on all SCCP cards, decides if the number of messages has crossed the provisioned threshold, and then communicates to the SCCP card to start throttling the messages.

The OAM will communicate to the SCCP card that the threshold for a particular Throttling GTT action has crossed. The SCCP card will then put that GTT action in the BLOCKED state for the remaining time of the current 30-second window. While the Throttling GTT Action is in the BLOCKED state, any MSU hitting that GTT action will be discarded.

The OAM will send a message to all SCCP cards once every 30 seconds to inform them that the previous 30-second window has expired and a new 30-second window has started. This GTT Action has the following parameters:

- **BURSTS** - parameter used to signify the number of previous 30 second windows from where the unused capacity can be carried over to the current window.
- **THRESHOLD** - If the count of MSUs hitting SFTHROT action exceeds this value, the MSU will be discarded.
- **DEFACTID** - Default Action ID. The default action that is performed when the `sfthrot` GTT Action fails.

A GTT Action set will only have a maximum of one SFTHROT GTT Action.

Figure 2-18 Throttling Framework

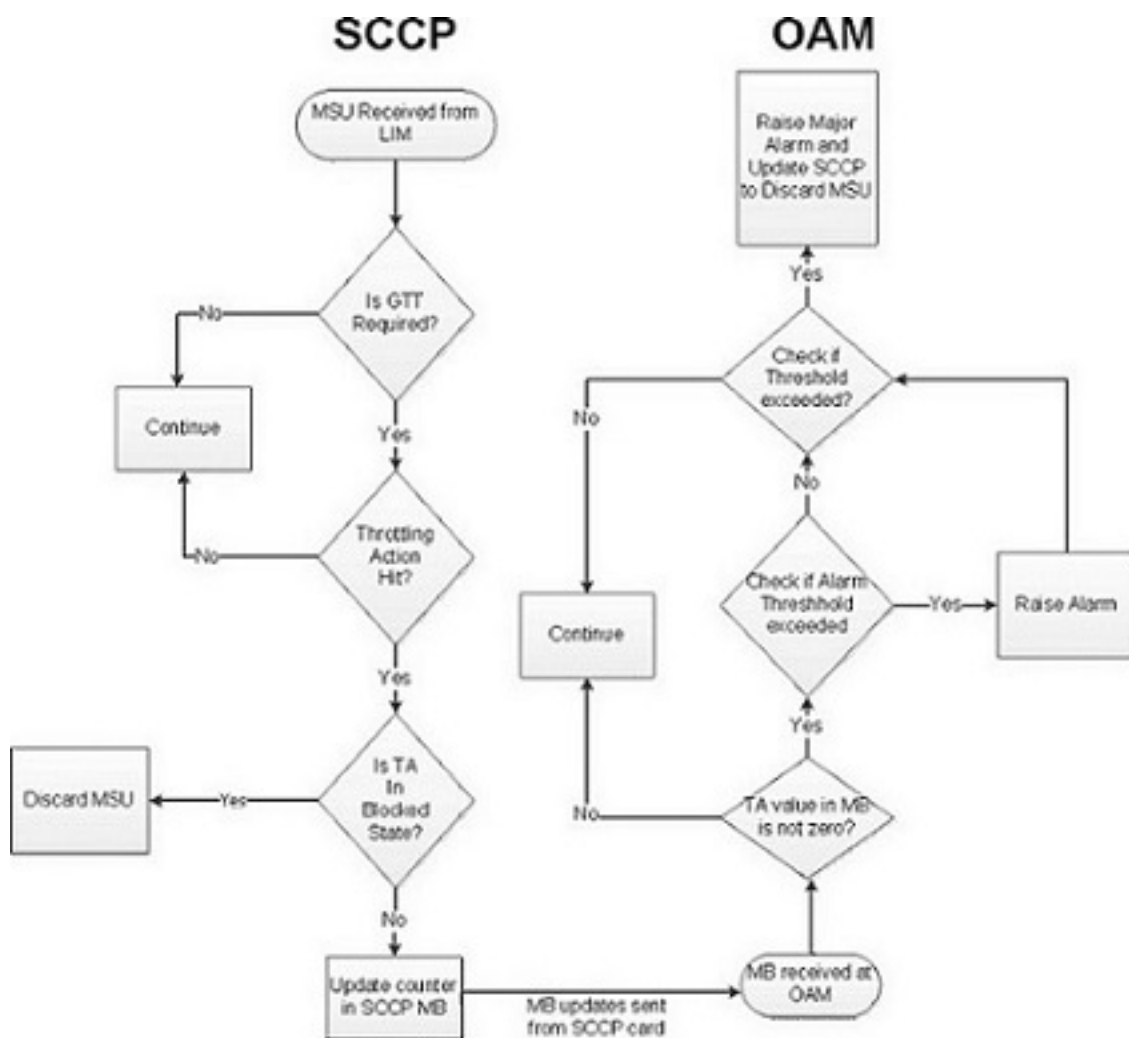

SFLOG GTT Action

The SFLOG GTT Action is used for logging. An SCCP card will be allowed to log up to 100 log event/second. The SCCP card will transfer all the log events for the MSUs that will hit the SFLOG GTT action. Two IPS cards will act as the Primary and Secondary Logging Card. At any given time, the Primary logging card will be actively logging.

The standby logging card will only be used for logging if the active logging card is unavailable for logging for an extended period of time.

Table 2-18 Roles and Responsibilities

SCCP Card	IPS Logging Card
Send the LOG events to the IPS card for the messages that hit the SFLOG GTT action	Determine if it is a primary or standby IPS logging card
Peg a system wide Measurement register to indicate overall Log Events in the system	Broadcast that decision to other IPS logging cards and the SCCP cards
Use MFC to flow-control messages to IPS card	Receive Log Events from SCCP cards and log them in a file in ASCII Format
Raise an Alarm if the logging capacity is exceeded	SFTP the collected log events to the primary server every 15 minutes Raise an Alarm if the primary SFTP server or both the primary and secondary servers cannot be reached

The SFTP Client interface will enable LOG events to be transferred from an EAGLE to other workstations. The file naming convention for the LOG SFTP reports is: `<clli>_sflog_<date in yymmdd format>_<time in hh24mmss>.pcap`. The EAGLE will provide an SFTP transfer of the LOG files after every 15 minutes. The EAGLE may also be configured to transfer LOG events periodically to a customer workstation. When the SFTP Client has been configured and the SFLOG GTT Action has been configured on some translation, the Logging Framework begins periodic transfers after collection completes for the next appropriate period.

The LOG event files to be transferred for that collection period are created and stored in IPS RAM Disk. The logging 15 minutes timer will start on both the SFLOG cards, Primary and Secondary (if configured), once the cards come into ACTIVE/IS-NR state. When the LOG event files have been generated, the Primary IPS logging card begins the file transfer to the Primary SFTP Server.

The IPS logging card does not know if an SFTP Server is up and running until it attempts a transfer. If a transfer fails, the transfer to the lowest priority number SFTP Server for the LOG file scheduled for that period is considered a failure, and the Logging system attempts to transfer the LOG file to the next higher priority number SFTP Server. It also raises a MINOR Alarm indicating the failure to transfer to the Primary SFTP Server.

SFTP Server priority is displayed in the `rtrv-ftp-serv` command output. The lower the number in the PRIO column, the higher the server priority.



Note:

Only SFTP servers configured for the SFLOG application are utilized by the Logging Framework for SFTP transfer.

If the IPS logging card is unable to establish a connection with any of the SFTP servers, a MAJOR Alarm is generated to record the file transfer failure event, and the LOG file scheduled for transfer is deleted from the file transfer repository. No further attempts are made to regenerate or transfer the file to the SFTP servers.

Release 46.3 implements the SFLOG MFC card service for the MFC interface. The SCCP uses this MFC service to send the log events to the IPS logging cards.

SCCP cards are the MFC client cards and IPS logging cards are MFC server cards for this MFC service. SCCP cards will only send the log event to the active IPS logging card (based on the broadcast message it gets from the active IPS logging card).

The log file will have the name `<clli>_sflog_<date in yymmdd format>_<time in hh24mmss>.pcap`. The timestamp in the file name will be the starting time of any 15 minute window.

 **Note:**

If the CLLI is changed, then the SFLOG cards should be booted to reflect the change in the LOG file name.

The log file format has the `libpcap` format already supported by EagleEyes.

A GTT Action set will only have a maximum of one SFLOG GTT Action.

SCPVAL GTT Action

The SCPVAL GTT Action is used to compare the SCCP digits and MAP digits. This GTT Action has the following parameters:

- `SPRM` - mandatory parameter used to decide whether the SCCP NP, NAI and GTA is picked up from CDPA or CGPA for comparison.
- `TPRM` - mandatory parameter used to decide whether the MAP digits, NP and NON, are picked from SMRPDA or SMRPOA for comparison.
- `NDGT` - parameter used to specify the number of digits that need to be matched between the SCCP parameter and MAP parameter. The minimum number of digits to match is 1 and the maximum is 21.
- `USEICMSG` - Use Incoming Message. Specifies whether to retrieve the data for comparison from the Original, i.e., as the message was received by SCCP (OFF), or Post-GTT, i.e., after possible EPAP/GTT translation/modification data has been applied (ON).
- `UIMREQD` - UIM Required. On generates a UIM in case of Action failure. Off does not generate a UIM in case of Action failure.
- `DEFACTID` - Default Action ID. The default action that is performed when the `scpval` GTT Action fails.

The user is able to provision SFAPP card information in the SFAPP GTT Action entry through SCFADDR. HLRADDR is used later on the SFAPP card.

The SFAPP GTT Action is controlled by the "GTT Action - SFAPP" parameter.

Figure 2-21 SFAPP Action Processing

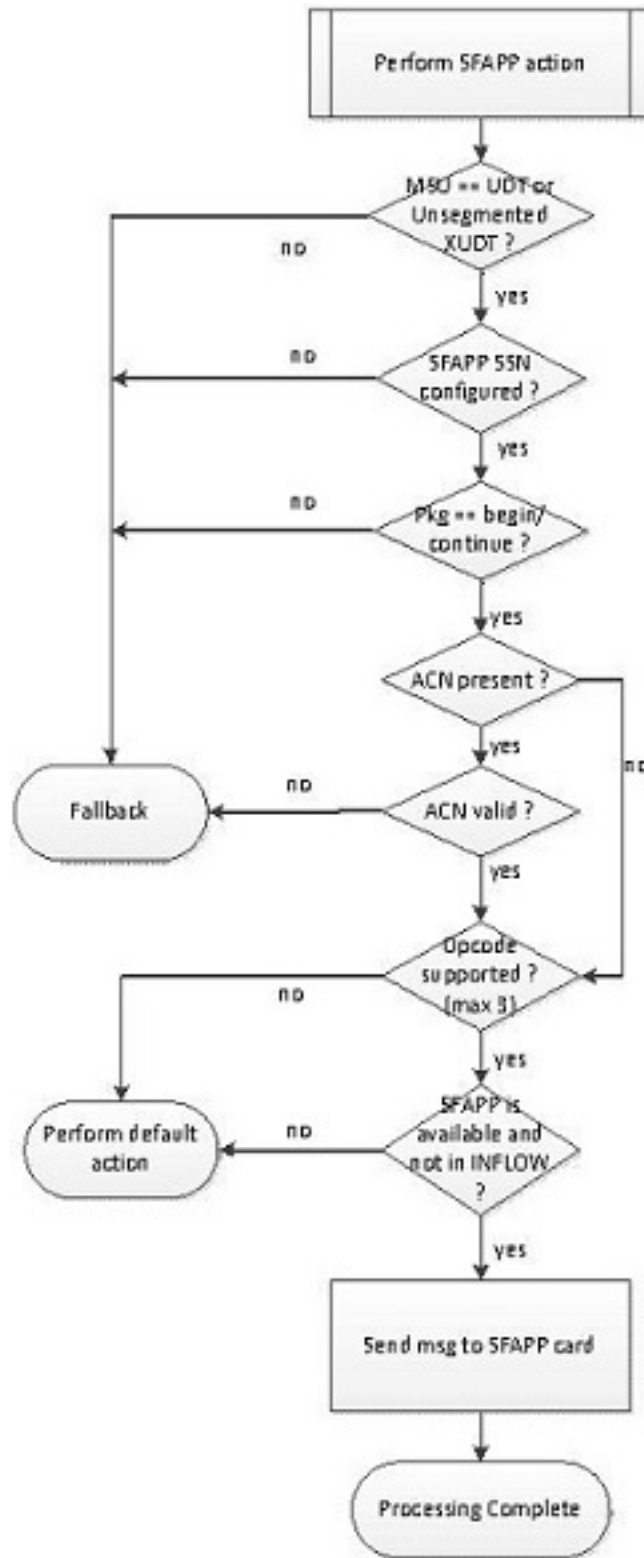

GTT Action Set

A GTT action set contains from one to six GTT action entries, the GTT action set ID which is used by global title address entries to reference the GTT action set, a test mode field whose value can be either on or off, and a reference count. The EAGLE can contain 20,000 GTT action sets.

A GTT action set is assigned to a global title address entry. The reference count in the GTT action set shows the number of global title address entries that reference the GTT action set. When a GTT action set is referenced by an global title address entry, the reference count is increased by 1. When a global title address entry no longer references the GTT action set, the reference count is decreased by 1. The GTT action set can be removed only when the reference count is zero. When the GTT action set is removed, the reference counts of GTT action entries that are in the GTT action set are decreased by 1. The data for each GTT action set is shown in the `rtrv-gttaset` output.

A GTT action set is provisioned using the `ent-gttaset` command with these parameters.

- `actsn` - the GTT action set name
- `actid1` - The GTT action entry ID shown in the `rtrv-gttact` output.
- `actid2` - The GTT action entry ID shown in the `rtrv-gttact` output.
- `actid3` - The GTT action entry ID shown in the `rtrv-gttact` output.
- `actid4` - The GTT action entry ID shown in the `rtrv-gttact` output.
- `actid5` - The GTT action entry ID shown in the `rtrv-gttact` output.
- `actid6` - The GTT action entry ID shown in the `rtrv-gttact` output.
- `on=testmode`
- `off=testmode`

The following rules apply for a GTT Action Set:

- The Forward, Discard, UDTS, TCAP Error and Services GTT Actions are mutually exclusive in a GTT Action Set.
- No GTT Action is allowed to repeat in a GTT Action Set. However, the GTT Action Set can contain multiple Duplicate GTT Actions and a maximum of 2 SCPVAL GTT Actions with different Action Ids.
- The GTT action set must contain at least one GTT action entry.
- The GTT action set Id must be unique in the GTT action set table.
- The user can provision a maximum of 5 Duplicate Actions and one of Forward/Discard/UDTS/TCAP Error/Services/SFLOG/SFTHROT and maximum of 2 SCPVAL Actions per Action Set.
- The user can provision a maximum of 2 SCPVAL Actions and one of Forward/Discard/UDTS/TCAP Error/Services/SFLOG/SFTHROT Actions or multiple Duplicate's per Action Set. The SPRAM and TPRM combination for both the SCPVAL GTT Actions in the same action set must be unique.
- The SFTHROT GTT Action will be the first GTT Action in a GTT Action Set. No GTT Action is allowed before this action in a GTT Action set.
- The GTT action entries can be provisioned in any order in the GTT action set as long as the GTT action entry that contains either the Forward, Discard, UDTS, TCAP Error, Services, SFLOG, SFTHROT GTT or SCPVAL action is the last entry

in the GTT action set. For example, the `actid4` parameter can be specified without specifying the `actid1` parameter. However, after specifying the `actid4` parameter with a Duplicate GTT action entry, the `actid1` parameter cannot be specified with a GTT action entry that contains either the Forward, Discard, UDTS, TCAP Error, Services, SFLOG, SFTHROT or SCPVAL GTT action. Another Duplicate GTT action entry can be specified for the `actid1` parameter.

- The user can provision only one SFAPP action. It is supported with Duplicate, Services, SFLOG and SFTHROT GTT Actions. It can only be the last GTT action in the action set.

A GTT action set can contain entries with these combinations of GTT actions.

- Forward
- Discard
- UDTS
- TCAP Error
- Services
- SFTHROT
- SFLOG
- SCPVAL
- SFAPP
- Duplicate (a maximum of 5 Duplicate Action Ids)
- Duplicate (a maximum of 5 Duplicate GTT Actions)/SFLOG/SCPVAL (a maximum of 2 SCPVAL GTT Actions), Discard (the last entry in the GTT action set)
- Duplicate (a maximum of 5 Duplicate GTT Actions)/SFLOG/SCPVAL (a maximum of 2 SCPVAL GTT Actions), UDTS (the last entry in the GTT action set)
- Duplicate (a maximum of 5 Duplicate GTT Actions)/SFLOG/SCPVAL (a maximum of 2 SCPVAL GTT Actions), TCAP Error (the last entry in the GTT action set)
- Duplicate (a maximum of 5 Duplicate GTT Actions)/SFLOG/SCPVAL (a maximum of 2 SCPVAL GTT Actions), Forward (the last entry in the GTT action set)
- SFTHROT, any other GTT Action
- Duplicate, SFLOG and SCPVAL GTT Actions can come in any order
- Duplicate (a maximum of 5 Duplicate GTT Actions)/SFLOG/Services/SFTHROT and SFAPP (in the same order)

The test mode field of the GTT action set entry defines whether or not the GTT action set is used for real-time MSU processing. The test mode field is provisioned by these two parameters.

- `on=testmode` - indicates that the GTT action set is used only by the test message tool.
- `off=testmode` - indicates that the GTT action set is used for real-time MSU processing.

The default value for the test mode field, if neither the `on=testmode` or `off=testmode` parameters are specified, is `off`.

GTA Entries and the Discard/UDTS/TCAP Error GTT Action

In previous releases, only the Discard and UDTS GTT actions could be assigned to a GTA entry, but the GTA entry could contain no routing data (the point code, SSN, routing indicator, MRN set and MAP set values). With the GTT Actions feature, the GTA entry that references the GTT action set that contains the Discard, UDTS, or TCAP Error GTT actions can contain routing data, although the routing data is not used during message processing. This allows the user to change the GTT action set that is being referenced by the GTA entry to a GTT action set that requires routing data, a GTT action set that contains either the Duplicate or Forward GTT actions, without having to provision the routing data for the GTA entry.

GTA Entries with the XLAT=NONE Parameter

In previous releases, the Discard and UDTS GTT actions were specified for the GTA entry with the `xlat=disc` and the `xlat=udts` parameters of the `ent-gta` or `chg-gta` commands. The GTT Actions feature allows a GTA entry to be provisioned with the `xlat=none` parameter. The GTA entry that contains the `xlat=none` parameter can contain any data except the routing data (the point code, SSN, and routing indicator). At any point of time, in a given GTT set, two GTA entries with same GTA value and different XLAT values are not allowed.

If during message processing a matching translation that contains the `xlat=none` parameter value is found, these actions occur.

- For successful non-GTT Message Relay Services, the MSU continues to use the routing data from the EPAP service or PPSOPTS table. If a GTT action set is associated with the matched translation, then the GTT actions in the GTT action set is applied to the MSU.
- For all other MSUs:
 - If the matching translation that contains the `xlat=none` parameter value and a GTT action set and:
 - * The GTT action set contains only one of these actions: Discard, UDTS, or TCAP Error GTT Action, then the matching translation is considered a match.
 - * The GTT action set that contains the Duplicate or Forward GTT actions, then the matching translation is not considered a match.
 - If a matching translation that contains the `xlat=none` parameter value and does not contain a GTT action set, the matching translation is not considered a match because there is no routing data. If none of the following conditions are present, the global title translation process has failed.
 - * If the Support for 16 GTT Lengths in VGTT feature is not enabled and turned on, the global title translation process may find the best match with a lesser number of digits that contains an `xlat` parameter value other than `none`.
 - * While searching for a matching translation using the Origin-Based SCCP Routing feature:
 - * For the advanced CdPA Mode, the translation containing the `xlat=none` parameter value is found in the advanced portion of CdPA translation, (SELID, OPTSN, or OPCS), and no further advanced CdPA processing is possible (for example, there is no optional OPCS defined), the next GTT mode in the GTT hierarchy is considered.
 - * For all other modes:

- * If there is no previously matched translation, the next GTT mode in the GTT hierarchy is considered, if the GTT mode is available.
- * If there is previously matched translation, the MSU is routed according to the data in the previously matched translation.

For example, while searching for a matching translation using the Origin-Based SCCP Routing feature, Set 3 Translation is found (see [Figure 2-22](#)). A matching translation that contains the `xlat=none` parameter value is found in SELID/Set 4. This is not considered a match. The MSU is routed based on the routing data in Set 3 Translation.

If Set 3 Translation is a CdPA GTA translation with an optional OPC set and a matching translation that contains the `xlat=none` parameter value is found in SELID/Set 4, and a matching translation that contains the `xlat=none` parameter value is found in the OPC set also, the next mode in the GTT hierarchy is selected.

Figure 2-22 Origin-Based SCCP Routing and XLAT=NONE

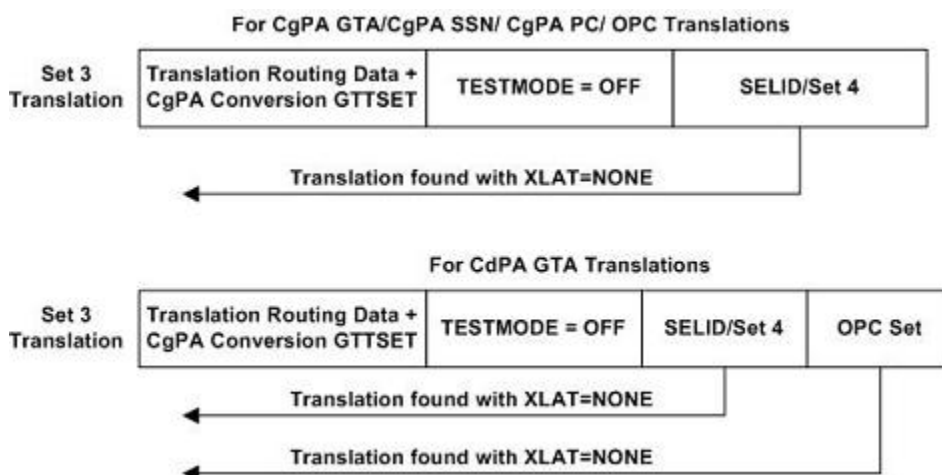

- While searching for a matching translation using the Flexible Linkset Optional Based Routing feature, if a translation that contains the `xlat=none` parameter value is encountered, the FALLBACK option of the previously found translation is used. If the FALLBACK option is set to yes, a match is made to the previously found translation. If the FALLBACK option is set to no, the global title translation process has failed. For example, while searching for a matching translation using the Flexible Linkset Optional Based Routing feature, Set 1 Translation is found (see [Figure 2-23](#)). A matching translation that contains the `xlat=none` parameter value is found in SELID/Set 2. This is not a match. The FALLBACK option of Set 1 Translation is used. Since the FALLBACK option is set to yes in Set 1 Translation, the MSU is routed based on the Set 1 Translation routing data.

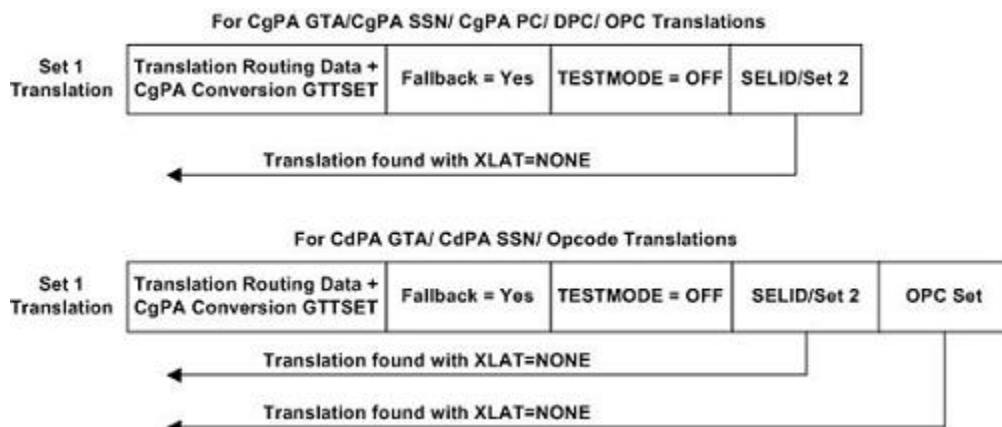
Figure 2-23 Interaction between the FALLBACK Option and XLAT=NONE

If Set 1 Translation is a CdPA GTA, CdPA SSN, or Opcode translation and a matching translation that contains the `xlat=none` parameter value is found in SELID/Set 2 as shown in Figure 2-22, a check for a matching translation is made in the OPC set. If a matching translation that contains the `xlat=none` parameter value is found in the OPC set, the FALLBACK option of Set 1 Translation is used. Since the FALLBACK option in Set 1 Translation is set to yes, the MSU is routed based on the Set 1 Translation routing data. If Set 1 is the very first GTT set that is found in the searching process and Set 1 Translation is provisioned with the `xlat=none` parameter value, then the global title translation process fails.

- For opcode translations, the global title translation process used the TCAP Opcode Based Routing feature to find the best matching translation.

GTT Action Per-TT Measurements

GTT action-related events recorded by the SCCP application are reported as system-wide totals, on a per-translation type basis (per-TT), and a per-path basis. The events recorded for GTT Actions are shown in Table 2-19 and Table 2-20.

Table 2-19 GTT Action Events Recorded for Per-TT and System-Wide Measurements Reports

Event Label	Description
GTTASET	The total number of messages receiving any GTT action.
GTTADUP	The total number of messages for which a Duplicate MSU was sent.
GTTADISC0	The total number of messages discarded by the DISCARD GTT action.
GTTADISC1	The total number of messages discarded by the UDTs GTT action.
GTTADISC2	The total number of messages discarded by the TCAP Error GTT action.
GTTAFWD	The total number of messages forwarded by the Forward GTT action.

Table 2-19 (Cont.) GTT Action Events Recorded for Per-TT and System-Wide Measurements Reports

Event Label	Description
GTTASRVGFLX	The total number of messages serviced by GFLEX GTT Action.
GTTASRVGPRT	The total number of messages serviced by GPORT GTT Action.
GTTASRVMSR	The total number of messages serviced by SMSMR GTT Action.

Table 2-20 GTT Action Events Recorded for Per-Path Measurements Reports

Event Label	Description
GTTACTNA	The total number of messages for which no GTT actions were performed.
GTTADUP	The total number of messages for which a Duplicate MSU was sent.
GTTADISC0	The total number of messages discarded by the DISCARD GTT action.
GTTADISC1	The total number of messages discarded by the UDTTS GTT action.
GTTADISC2	The total number of messages discarded by the TCAP Error GTT action.
GTTAFWD	The total number of messages forwarded by the Forward GTT action.
GTTASRVGFLX	The total number of messages serviced by GFLEX GTT Action.
GTTASRVGPRT	The total number of messages serviced by GPORT GTT Action.
GTTASRVMSR	The total number of messages serviced by SMSMR GTT Action.

The per-translation type report contains a breakdown of the GTT action events for each of the translation types provisioned in the database, up to a maximum of 256 translation types. This data is available for every 30-minute interval, and for every 15-minute interval if the 15-Minute Measurements feature is enabled and turned on. The GTT Actions system-wide measurements report provides the totals of all the actions that were performed on the EAGLE for all the GTT action sets. This report is available for every 30-minute interval, and for every 15-minute interval if the 15-Minute Measurements feature is enabled and turned on.

GTT Action Per-Path Measurements

The GTT action per-path measurements provides measurement counts for the GTT actions applied to the messages that match a pre defined combination of “CgPA GTA”, “CdPA GTA”, and “Opcode” values. The combination of these values are provisioned in the GTT Path table with the `ent-gttapath` command. Each entry in the GTT Path table must be unique combination of CdPA GTA, CgPA GTA and Opcode values and this combination is called a path. If a translation search in Global Title Translation table matches the path specified in GTT Path table, then the corresponding measurement counts for that path are incremented. However, if the `ppmeasreqd` parameter (Per

Path Measurements required) value for the final translation is `no`, then the per-path measurement counts for the matching path are not pegged.

A GTT action path entry set is provisioned using the `ent-gttapath` command with these parameters.

- `gttpn` - the GTT action path name
- `opgttsn` - the opcode GTT set name shown in the `rtrv-gttset` output.
- `opcode` - the opcode value shown in the `rtrv-gta` output that is assigned to the `opgttsn` value.
- `pkgtype` - the package type value shown in the `rtrv-gta` output that is assigned to the `opgttsn` value.
- `family` - the family value shown in the `rtrv-gta` output that is assigned to the `opgttsn` value.
- `acn` - the ACN value shown in the `rtrv-gta` output that is assigned to the `opgttsn` value.
- `cggtsn` - the CGGTA GTT set name shown in the `rtrv-gttset` output.
- `cggta` - the CGGTA shown in the `rtrv-gta` output that is assigned to the `cggtsn` value.
- `cdgtsn` - the CDGTA GTT set name shown in the `rtrv-gttset` output.
- `cdgta` - the CDGTA shown in the `rtrv-gta` output that is assigned to the `cggtsn` value.

An example of a GTT action path entry is shown in [Figure 2-24](#).

Figure 2-24 GTT Action Path Entry

Entry #	GTT SET Name (Opcode Type)	Package Type	Opcode	Application Context Name	Family	GTT Set Name (CgPA Type)	CGPA GTA	ECGPA GTA	GTT Set Name (CdPA Type)	CDPA GTA	ECDGTA GTA
1	opsn1	rsp	23	--	22	cgsn1	53652	--	cdsn1	12345	--
2	opsn2	ansiuni	23	--	22	--	--	--	cdsn2	12345	--

The GTT Action path table can contain a maximum of 10,000 entries. A GTT path entry shall have up to three GTT set-value combinations in it, where the GTT set and value must be a valid entry in the GTT Translation table. However, a GTT path must be provisioned with at least one GTT set and value (CdPA GTA/CgPA GTA/Opcode). For every GTT action path, the GTT set and the value must be specified together as a combination. If the GTT Set-value combination is not provisioned in a GTT action path then it is considered as no value and is displayed as “----” in the `rtrv-gttapath` output for that combination. Translation entries cannot be removed or modified (in case of GTA range splitting) if the entries are referenced in a GTT action path. [Figure 2-25](#) shows the relation between the two tables.

Figure 2-25 GTT Translation and GTT Action Path Table Relationship

Translation Type	Translation Data	Translation Specific Data	Per Path Measurement is Required
CdGTA	12345	...	Yes
CgGTA	53652	...	No
Opcode	23	...	No
CdGTA	1256	...	Yes
CgGTA	53659	...	No

Entry #	GTT SET Name (Opcode Type)	Package Type	Opcode	Application Context Name	Family	GTT Set Name (CgPA Type)	CGPA GTA	ECGPA GTA	GTT Set Name (CdPA Type)	CDPA GTA	ECDGTA GTA
1	opsn1	rsp	23	-	22	cgsn1	53652	-	cdsn1	12345	-
2	opsn2	ansiuni	23	-	22	-	-	-	cdsn2	12345	-
3	-	-	-	-	-	cgsn2	53659	-	cdsn2	1256	-

The GTT actions per-path measurements report contains the GTT Action events for the predefined GTT paths that are provisioned in the database, up to a maximum of 10,000 predefined paths. The per-path measurement data is collected during the 60 minute interval period (per hour). The hourly data is retained for 24 hours. The daily collection data is retained for seven days. The data collection reports are available as both scheduled and on-demand reports. The events recorded for the GTT actions per-path measurements is shown in [Table 2-20](#).

Per path measurements for a GTT path are pegged if these conditions are present.

- A matching global title translation was found for at least one of the CdPA GTA/ CgPA GTA/ Opcode values.
- The `ppmeasreqd` parameter value in the global title translation is `yes`.
- The matching CdPA GTA/ CgPA GTA/ Opcode translation combination is provisioned in GTT action path table.

GTT Action Path Entry Searched with all the GTT Set-Value Combinations Specified

All three specified GTT Set-value combinations (opcode/CgPA/CdPA) are provisioned in a GTT action path in GTT action path table as shown in [Figure 2-26](#).

Figure 2-26 Example GTT Action Path Table Entry

Entry #	OPGTTSN	PKGTYP	OPCODE	ACN	FAMILY	CGGTTSN	CGPAGTA	ECGPAGTA	CDGTTSN	CDPAGTA	ECDGTA
1	opsn1	ituuni	22	1-2-1-1-1-1-1	-	cgsn1	1234	1234	cdsn1	2345	2345
2	opsn2	ansiuni	12	-	24	-	-	-	cdsn2	12345	12345
3	opsn3	bgn	10	-	22	cgsn3	12345678	12345678	-	-	-

The per-path measurements are pegged for this GTT action path entry only if:

- The `ppmeasreqd` parameter value in the global title translation is `yes`.
- All the specified GTT set-value combinations were searched in any order during the global title translation lookup.

Figure 2-27 GTT Translation Lookup - Exact GTT Action Path Match

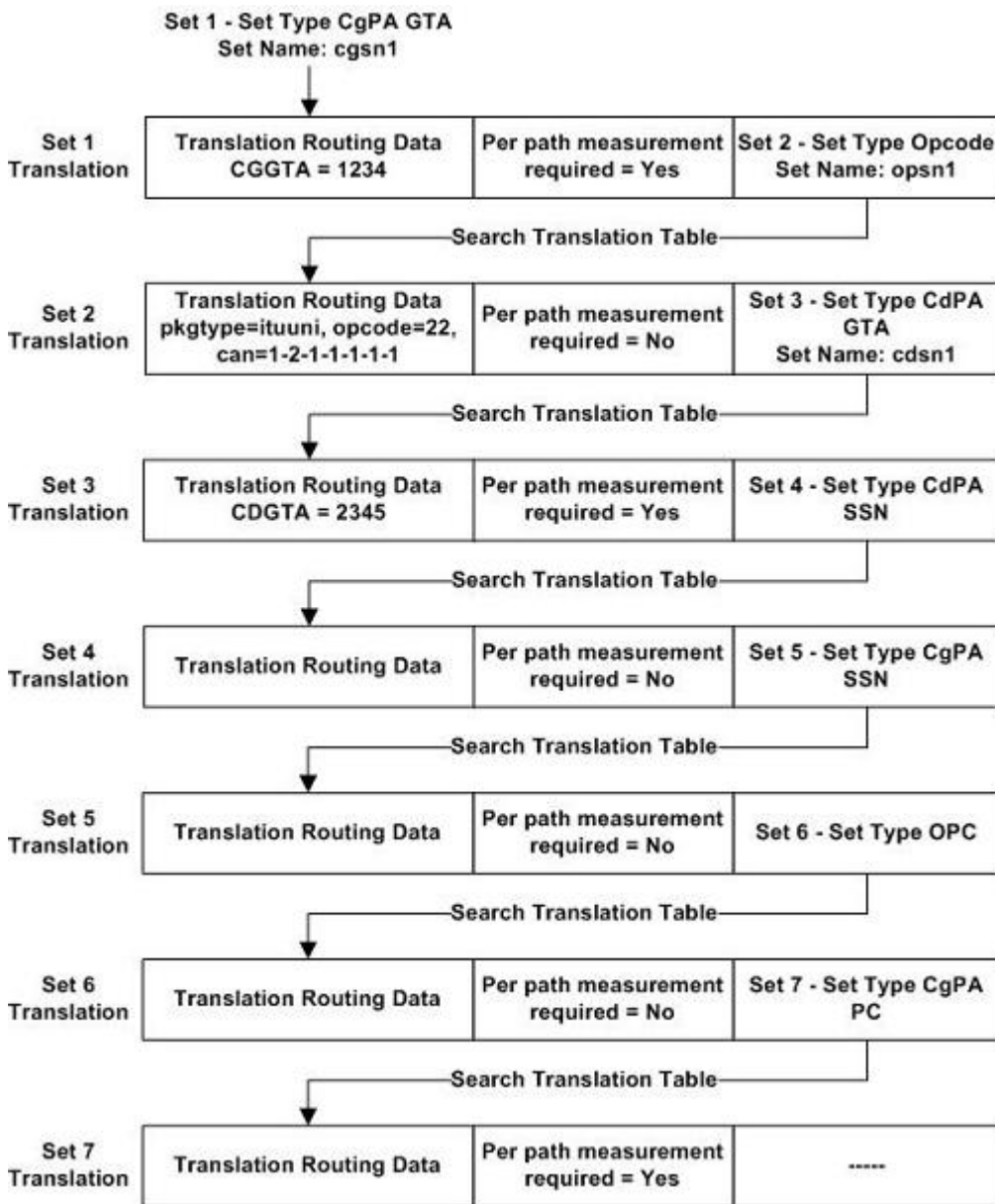

In [Figure 2-27](#), searches are performed for this translation data.

- Set 1 - CGGTTSN = cgsn1 - CGGTA = 1234
- Set 2 - OPGTTSN = opsn1 - Opcode = 22
- Set 3 - CDGTTSN = cdsn1 - CDGTA = 2345

This combination matches the entry # 1 in the GTT action path table shown in [Figure 2-26](#). Since the per-path measurement required value is set to Yes in Set 7 (the

translation result), entry #1 in Figure 2-26 is pegged in the per-path measurements report. If the per-path measurement required value is set to No in Set 7, then entry #1 in Figure 2-26 is not pegged in the per-path measurements report.

GTT Action Path Entry Not Searched in the Translation Lookup

If a GTT set-value combinations search is performed during the translation lookup, and all the searched combinations do not match any of the provisioned GTT action paths, then the per-path measurements are not pegged.

Figure 2-28 GTT Translation Lookup - No GTT Action Path Match

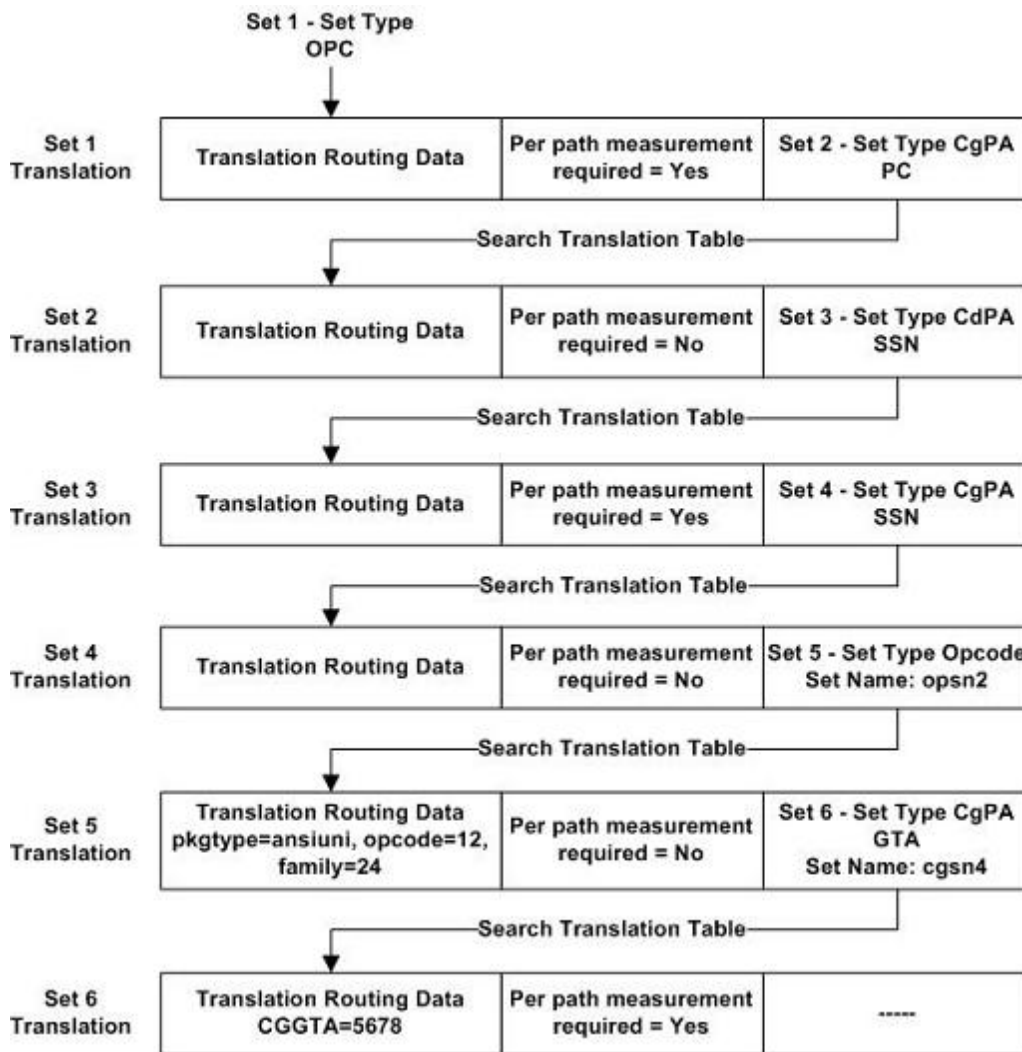

In Figure 2-28, a search is performed for this translation data during the global title translation lookup. CDPA GTA and CgPA GTA searches were not performed.

Opcode GTT Set Type	Set 5	OPGTTSN=opsn2	OPCODE=12
---------------------	-------	---------------	-----------

The entries in Figure 2-26 do not contain any entries that have only an Opcode entry, so the per-path measurements are not pegged.

GTT Path Entry Searched with Some GTT Set-Value Combinations Specified

Suppose only the Opcode and CgPA GTA GTT set-value combinations are provisioned in a GTT action path, as shown in entry #3 in Figure 2-26. The per-path measurements are pegged for this GTT action path entry only if:

- The per-path measurement required value in the resulting translation is set to Yes.
- The matching translation entry was found for both the CgPA and Opcode GTT set-value combination.
- Either the search was not performed on CdPA GTA or no matching translation entry was found for the CdPA GTA.

Figure 2-29 GTT Translation Lookup - Exact GTT Action Path Match (with Unspecified GTT Set-Value Combinations)

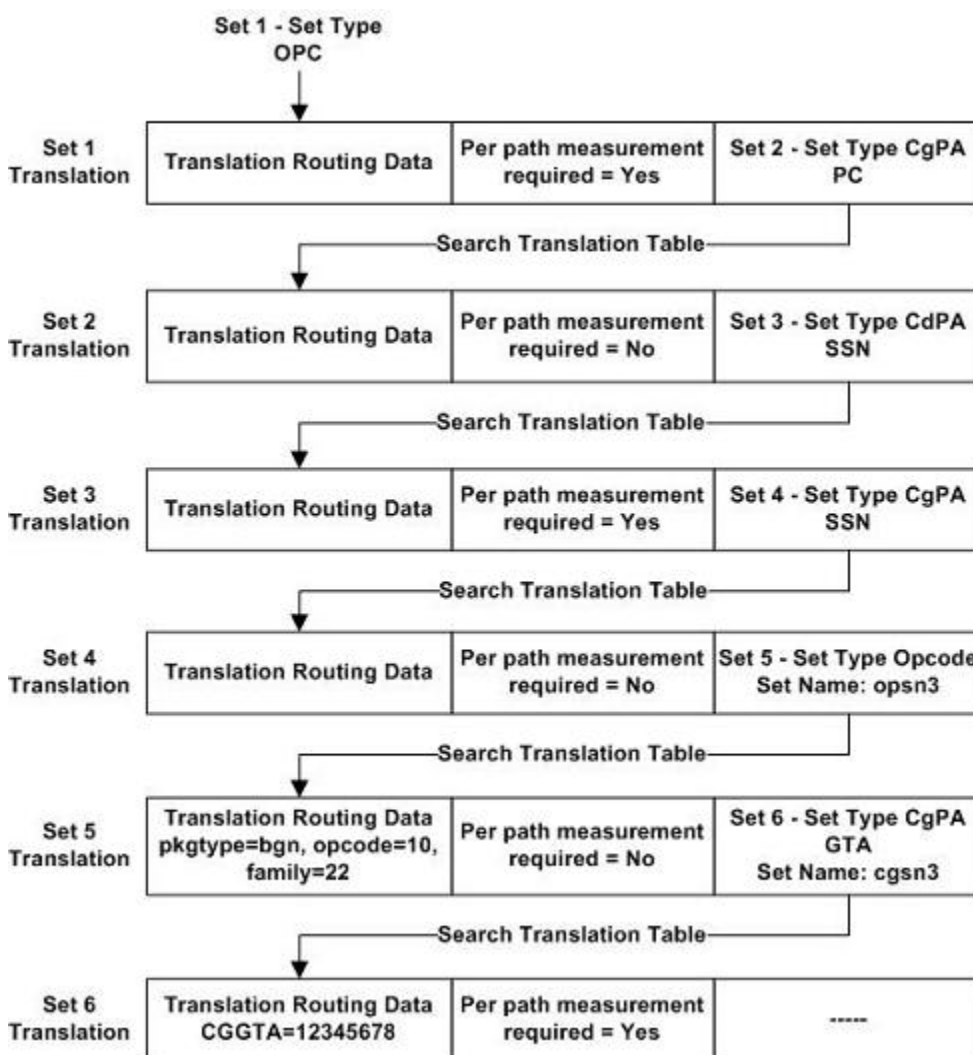

In Figure 2-29, searches are performed for this translation data during the global title translation lookup. CDPA GTA search was not performed

Opcode GTT Set Type	Set 5	OPGTTSN=opsn3	OPCODE=10
CGPA GTT Set Type	Set 6	CGGTTSN=cgsn3	CGGTA=12345678

The searched CGPA GTA/CdPA GTA/OPCODE values matches Entry #3 in [Figure 2-26](#) where the CDPA GTA is provisioned as none. Since the per-path measurement required value is set to Yes in Set 6 (the translation result), entry #3 in [Figure 2-26](#) is pegged in the per-path measurements report.

Provisioning the GTT Actions Feature

To provision the GTT Actions feature, perform these steps.

1. Turn the GTT and EGTT features on using the `chg-feat` command. Add the required service modules to the database using the `ent-card` command. Perform the [Adding a Service Module](#) procedure.
2. Enable and turn on one or more of these features using the `enable-ctrl-feat` and the `chg-ctrl-feat` commands.
 - To perform the GTT actions Discard, UDTS, or TCAP Error - GTT Action – DISCARD – 893027501
 - To perform the GTT action Duplicate - GTT Action – DUPLICATE – 893027601
 - To perform the GTT action Forward - GTT Action – FORWARD – 893037501

Perform the [Activating the GTT Actions Features](#) procedure to enable and turn on these features.

3. Provision the required GTT actions using the `ent-gttact` command by performing the [Adding a GTT Action](#) procedure.
4. Provision the required GTT action sets using the `ent-gttaset` command by performing the [Adding a GTT Action Set](#) procedure.
5. Provision the required GTT translations using the `ent-gta` command. Perform [Adding Global Title Address Information](#).

To provision the GTT action paths, perform these steps.

1. Perform the [Activating the GTT Actions Features](#) procedure to enable and turn on these features.
 - To perform the GTT actions Discard, UDTS, or TCAP Error - GTT Action – DISCARD – 893027501
 - To perform the GTT action Duplicate - GTT Action – DUPLICATE – 893027601
 - To perform the GTT action Forward - GTT Action – FORWARD – 893037501
2. Provision the required GTT sets using the `ent-gttset` command. Perform [Adding a GTT Set](#).
3. Provision the required GTT translations using the `ent-gta` command. Perform [Adding Global Title Address Information](#).
4. Provision the required GTT action paths using the `ent-gttapath` command by performing the [Adding a GTT Action Path Entry](#) procedure.

Support for CAT2 SS7 Security

The CAT2 SS7 Security functionality allows Eagle to detect anomalies on inbound Category 2 packets through bulk upload of customer IR.21 documents.

 **Note:**

The IR.21 document contains operator wise network information such as, MCC-MNC, Node GT (HLR/VLR/MSC), and CC-NDC.

The CAT2 SS7 security functionality is achieved using the CAT2 Utility. This utility is external to EAGLE and can be downloaded from the Oracle Software Delivery Cloud along with the other EAGLE components.

The CAT2 Utility is used for reading and recording the information present in GSMA IR.21 document into database tables. The SCPVAL GTT Action addresses the SS7 CAT2 security checks. This GTT action ensures that the MSU details such as, CgPA and IMSI belongs to same operator after validating it with the newly generated table.

CAT2 SS7 Security Workflow

The following flow chart provides an overview of the CAT2 SS7 Security functionality:

Figure 2-30 CAT2 SS7 Security Workflow

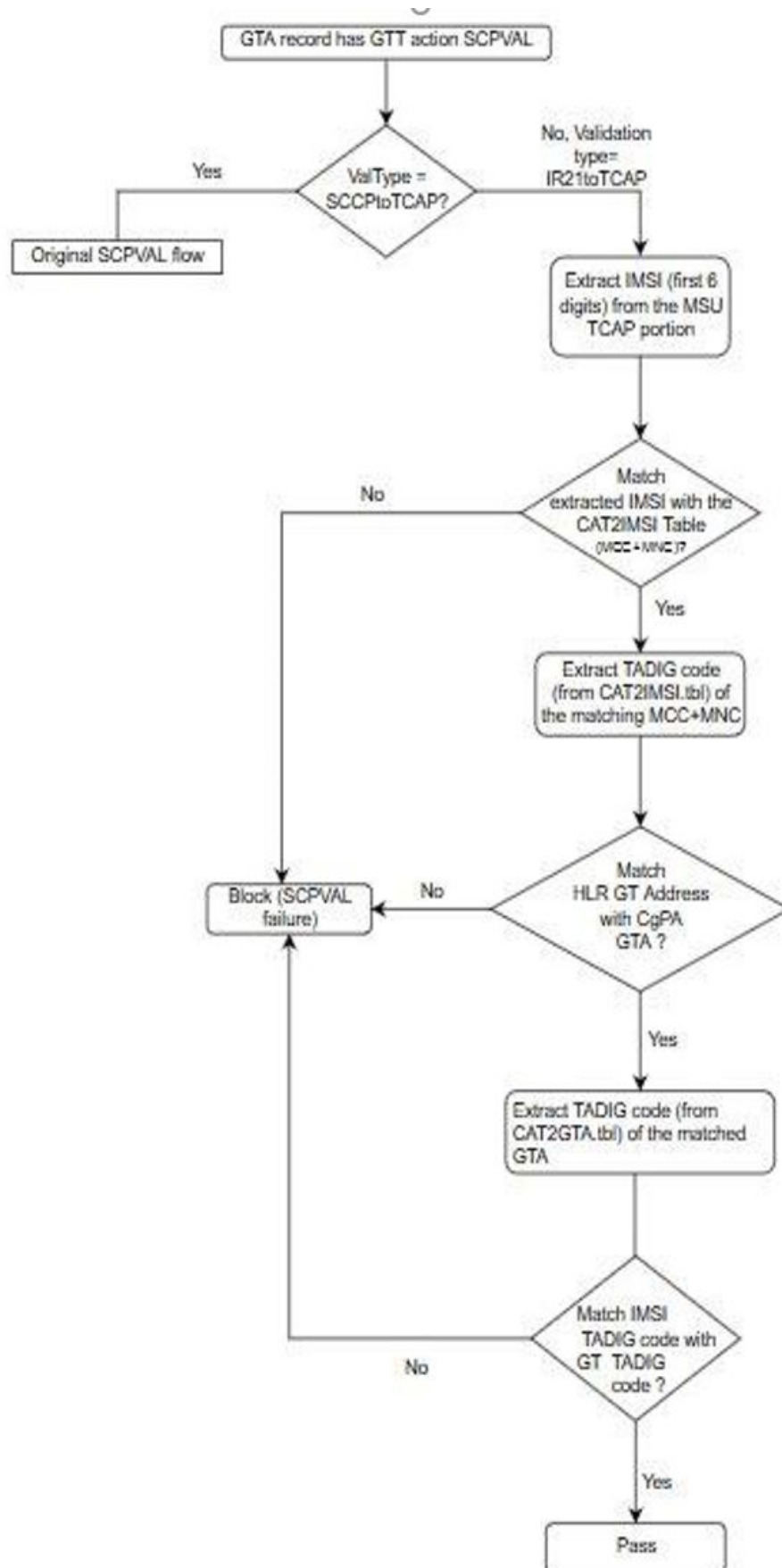

The CAT2 SS7 Security functionality is described as follows:

- The IR.21 XML file is parsed on a linux machine using the external CAT2 Utility. The utility extracts the information required from the IR.21 file for validation of the message and convert the data in tabular format to be used in EAGLE.IR.21 input file in XML format and generate error message in case of no or other than IR.21 XML files.
- The output is generated in CAT2IMSI and CAT2GTA tables and the network card supporting SCCP functionality gets updated along with table data. The following data is extracted from IR.21 file and stored on EAGLE:
 - Sender TADIG code (RAEX IR.21 Information) : It is retrieved from the RAEX IR.21 FileHeader tag and used to identify the operator. It consist of two fields, with a total length of five characters consisting of three-character country code and a two character operator or company idenfier. Sender TADIG code is stored against each entry in both the tables.
 - Routing Information Data (Section ID 4) : It is a mandatory section in IR.21 document of the operator. The EAGLE CAT2IMSI table stores the MCC-MNC (E.212) along with TADIG code from this section. The EAGLE CAT2GTA stores the CC-NC (from E.214) along with TADIG code from this section.
 - Network Element Information Data (Section ID 13) – It is an optional section in IR.21 document of the operator. The EAGLE CAT2GTA table stores the HLR Node type GT address or Address range along with the TADIG code from this section.
- The SCPVAL GTT action validates that the MSU details: CgPA and IMSI belongs to same operator. The validation is based on the following two rules:
 - The IMSI within MAP layer of a message must match with the IMSI prefixes (MCC + MNC) of the protected network.
 - The OperatorID (TADIG code) referenced by all parameters in the MAP layer of the message (IMSI and HLR) must match with the OperatorID referenced by the matching IR.21 nodal GT ranges.
The MSUs that passes these rules are considered as free from CAT2 anomalies.

All the supported Category 2 Opcodes are screened with these rules. If the first rule passes, then only MSU validates for the second rule. Otherwise, the SCPVAL GTT Action is considered as failure.

Considerations for Validation

- The following Opcodes are applicable for CgPA and IMSI validation:
 - ProvideRoamingNumber (4)
 - ProvideSubscriberInformation (70)
 - ProvideSubscriberLocation (83)
 - CancelLocation (3)
 - InsertSubscriberData (7)
 - DeleteSubscriberData (8)
 - Reset (37)
 - ActivateTraceMode (50)

- UnstructuredSS-Request (60)
- UnstructuredSS-Notify (61)
- AlertServiceCentre (64)
- SetReportingState (73)
- IstCommand (88)
- RemoteUserFree (75)
- The IMSI has upto 15 digits value. The value is composed of three parts:
 - **Mobile Country Code (MCC)**: Consists of 3 digits
 - **Mobile Network Code (MNC)**: Consists of 2 or 3 digits
 - **Mobile Subscriber Identification Number (MSIN)**: 9 or 10 digits

The MCC and MNC parameters (first 5-6 digits) determine the Operator ID. Hence, these values are used during CAT2 validation.

At first, the match is performed with 6 digit, and if the match is not found, then it is performed with 5 digits. In case, the match is not found, the validation gets failed.

Executing CAT2 SS7 Security Functionality

Perform the following steps to install and execute the CAT2 validation:

1. Execute the following command to create a directory to keep CAT2 related RPM on a linux machine.

```
mkdir <directore name>
```

2. Execute the following command to switch control to the newly created directory:

```
cd <directore name>
```

3. Download the RPM package for CAT2 Utility from Oracle Software Delivery Cloud and copy to the newly created folder.

 **Note:**

The IR21 xml files must also be placed on the same linux machine.

4. Execute the following command to install the RPM:

```
rpm -ivf <rpm_name>
```

 **Note:**

Remove any already installed CAT2 Utility package before installing a new one. To remove execute the command:

```
rpm -e <package_name>
```

5. After successful installation, the new CAT2 Utility folder `CAT2_utl` is created. Access the folder with the following command:

```
cd /usr/TKLC/CAT2_utl/
```

6. Enter the command:

```
ls
```

The command lists the available files in the folder:

- `sftpclient`
- `runUtility`
- `createTBL.class`
- `createTBL$2.class`
- `createTBL$1.class`

7. Create 2 new folders **INPUT** and **OUTPUT**. Execute:

```
mkdir INPUT  
mkdir OUTPUT
```

The **INPUT** and **OUTPUT** folders are created to run the utility.

8. Execute the utility using the following command after placing IR.21 files on the linux machine:

```
./runUtility.x
```

The utility perform the CAT2 SS7 Security validation.

9. Copy all IR21 xml files in the **INPUT** folder. This folder can convert maximum of 1000 IR21 xml files to CAT2 8.
10. Execute the utility with the following command:

```
./runUtility
```

MTP Routed Global Title Translation

In previous releases, MTP routed SCCP messages are routed to the service module if either the MTP Msgs for SCCP Apps feature, part number 893017401, is enabled

and turned on, or the MSU is screened by the Gateway Screening stop action SCCP. These actions were performed on the service modules

1. EPAP service handling is performed.
2. If the EPAP service handling resulted in Fall through to MTP routing, then MTP Routed GSM MAP Screening is performed, if applicable.
3. The MSU is MTP routed if the message is not discarded by MTP Routed GSM MAP Screening.

In addition to the actions that were performed in previous releases, global title translation and GTT Actions are performed on MTP routed MSUs similar to the existing global title translation GTT handling for GT routed MSU's. Global title translation on MTP routed MSUs is performed if the service handling results in Fall through to GTT or if the GTT required option in the service selector is set to on for the service relayed MSU.

Two parameters have been added to the `chg-sccpopts` command to determine how MTP routed MSUs are handled. The first parameter is `mtprggt` which specifies whether global title translation is performed on an MTP routed MSU and the routing that is performed on the MSU after global title translation is performed. The `mtprggt` parameter is contains these values.

- `off` - global title translation is not performed on the MTP routed MSU.
- `usemtppc` - global title translation is performed on the MTP routed MSUs and the MSU is sent to the original DPC.
- `fullggt` - global title translation is performed on the MTP routed MSU and the MSU is sent to the translated DPC.

The second parameter is `mtprggtfailbk` which specifies whether an MTP routed MSU is MTP routed after the failure of the global title translation process.

- `mtproute` - perform MTP routing on the MSU if a failure occurs during the global title translation process.
- `ggttfail` - discard the MSU if a failure occurs during the global title translation process. Send a UDTs message if required.

Unique GTT Selectors

In previous EAGLE releases that did not support the Unique GTT Selectors feature, all ITU GTT selectors shared the same space in the GTT selector table. Only one entry for an ITU GTT selector that contains a specific GTI and translation type value, regardless of the network type or domain of the ITU GTT selector, could be defined in the GTT selector table. For example, if the GTT selector table contained an ITU-I GTT selector with the GTI value 2 and the translation type value 5, this GTI and translation type value combination could not be assigned to an ITU-N or ITU-N24 GTT selector.

When the EAGLE is upgraded from a release that did not support the Unique GTT Selectors feature to a release that does support the Unique GTT Selectors feature, the ITU GTT selectors created in the previous release become overlapped GTT selectors.

The Unique GTT Selectors feature does not allow overlapped GTT selectors to be provisioned in the GTT selector table. All new GTT selectors that are created in the release that supports the Unique GTT Selectors feature are non-overlapped GTT selectors. The Unique GTT Selectors feature allows for ITU GTT selectors to be provisioned with these attributes.

- ITU-I spare and ITU-N spare GTT selectors
- Provisioning the same translation type and GTI values for ITU GTT selectors of all network types including the ITU-I spare and ITU-N spare network types.
- GTT selectors of all network types including ITU-I spare and ITU-N spare network types that contain the GTI value 0 (zero).

In a release that does support the Unique GTT Selectors feature, the user is able to add more GTT Selectors for the existing overlapped GTT Selector as long as the GTIx (ITU domain only) and TT combination matches the existing overlapped GTT Selector.

The user will not be able to add a new non-overlapped GTT selector entry if the GTIx (ITU domain only) and TT combination matches to an existing overlapped GTT Selector entry created during upgrade to a release that supports the Unique GTT Selectors feature from a release that did not support it. The `unqggttsel` parameter in the SCCPOPTS table controls run-time behavior of the Unique GTT Selector feature; when it is set to "exactmatch," overlapped entries will behave as non-overlapped entry.

Any new entries added in a release that supports the Unique GTT Selectors feature, with the GTIx and TT combination that were not present in the system while upgrading to a release that supports the Unique GTT Selectors feature, will be added as non-overlapped entries.

The provisioning of ITU-I spare and ITU-N spare GTT selectors is the same as provisioning ITU-I and ITU-N GTT selectors. This includes the provisioning of default GTT selectors using the `ent-tt` command. For more information about using the `ent-tt` command to provision default GTT selectors, see the [Adding a Translation Type](#) procedure.

GTT Selectors with the GTI Value of 0

With the Unique GTT Selectors feature, The EAGLE can process MSUs whose GTI value is 0 (a GTI=0 GTT selector) for all network types, including ITU-I spare and ITU-N spare. A GTI=0 GTT selector cannot contain `tt`, `np`, `nai`, and `Eagle-Gen` values. A GTI=0 GTT selector can contain `lsn` (the name of a linkset), `selid`, and `cgssn` values. The values that can be specified for a GTI=0 GTT selector is determined by the features that are enabled and turned on.

GTT Selector Key for GTI=0 GTT Selectors

[Table 2-21](#) defines the keys in the GTT selector table based on the feature combination for GTI=0 GTT selectors. If a feature supports specific parameters and that feature is not enabled or turned on, then default values are entered into the database for those parameters.

Table 2-21 GTT Selector Key for GTI=0

Feature Combination	Selector Type	GTI, Domain	CgPA SSN	SELID	Link Set Name
EGTT	CdPA Only	X	-	-	-
Origin-Based	CdPA	X	-	-	-
SCCP Routing	CgPA	X	X	X	-
Flexible Linkset Optional	CdPA	X	-	X	X

Table 2-21 (Cont.) GTT Selector Key for GTI=0

Feature Combination	Selector Type	GTI, Domain	CgPA SSN	SELID	Link Set Name
Based Routing	CgPA	X	-	X	X
Origin-Based	CdPA	X	-	X	X
SCCP Routing and Flexible Linkset	CgPA	X	X	X	X
Optional Based Routing					

Searching Order for GTI=0 GTT Selectors

Table 2-22 and Table 2-23 shows the searching order for CdPA and CgPA GTI=0 GTT Selectors.

Table 2-22 Searching Order for CdPA GTI=0 GTT Selectors

CdPA GTT Selector Keys				
Priority	GTA, Domain	Linkset ID	SELID	CdPA GTT Selector Found or Not Found
1	Exact	Exact	Exact	If a meaningful CdPA GTT set is provisioned, then the GTT selector is considered found. If a meaningful CdPA GTT set is not provisioned, then the GTT selector is considered not found.
2	Exact	Any	Exact	

Table 2-23 Searching Order for CgPA GTI=0 GTT Selectors

CgPA GTT Selector Keys					
Priority	GTA, Domain	Linkset ID	SELID	CgPA SSN	CgPA GTT Selector Found or Not Found
1	Exact	Exact	Exact	Exact	If a meaningful CgPA GTT set is provisioned, then the GTT selector is
2	Exact	Exact	Exact	Any	
3	Exact	Any	Exact	Exact	
4	Exact	Any	Exact	Any	

Table 2-23 (Cont.) Searching Order for CgPA GTI=0 GTT Selectors

CgPA GTT Selector Keys					
Priority	GTA, Domain	Linkset ID	SELID	CgPA SSN	CgPA GTT Selector Found or Not Found
5	Exact	Any	Any	Any	considered found. If a meaningful CgPA GTT set is not provisioned, then the GTT selector is considered not found.

For the Origin-Based SCCP Routing feature GTT hierarchy, meaningful means following the Origin-Based SCCP Routing feature rules; the GTT set type of a CdPA GTT set must be CDGTA and the GTT set type of a CgPA GTT set must be either CGGTA or CGPC. If a Flexible Linkset Optional Based Routing feature GTT hierarchy is being used, then any GTT set type can be used.

The Linkset ID, SELID, and CGSSN parameters are controlled by the Flexible Linkset Optional Based Routing and Origin-Based SCCP Routing features. If a parameter is not allowed, it assumes the value of Any in the database. In [Table 2-22](#) and [Table 2-23](#), if a parameter is specified as Exact and that parameter is not allowed, then the Exact value is the same as the Any value.

Using the Unique GTT Selectors Feature

To determine how a GTT selector search is performed on overlapped GTT selectors, the `unqgttsel` parameter of the `chg-sccpopts` command is used. The `unqgttsel` parameter contains these values.

- `bestmatch` - search for overlapped GTT selectors if non-overlapped GTT selectors are not found.
- `exactmatch` - search only for non-overlapped GTT selectors.

When the `unqgttsel` parameter is applied to GTI=2 and GTI=4 GTT selectors, these actions occur.

- When the `unqgttsel` parameter value is `bestmatch`:
 - A non-overlapped GTT selector is matched, if it is in the database, using the searching rules defined by the EGTT, Origin-Based SCCP Routing features, Flexible Linkset Optional Based Routing, and TCAP Opcode Based Routing features.
 - If a non-overlapped GTT selector is not found, an overlapped GTT selector is matched, if it is in the database, using the searching rules defined by the EGTT, Origin-Based SCCP Routing features, Flexible Linkset Optional Based Routing, and TCAP Opcode Based Routing features.

- If a matching non-overlapped or overlapped GTT selector is not found, the search fails.
- When the `unqgtsel` parameter value is `exactmatch`:
 - A non-overlapped GTT selector is matched, if it is in the database.
 - If a matching non-overlapped GTT selector is not found, the search fails.

When the `unqgtsel` parameter is applied to `GTIx=0` GTT selectors, these actions occur.

- When the `unqgtsel` parameter value is `bestmatch`:
 - An exact `GTIx=0` GTT selector is matched, if it is in the database, using the searching order shown in [Table 2-22](#) and [Table 2-23](#).
 - If an exact `GTIx=0` GTT selector match is not found, an overlapped GTT selector (ANSI and ITU-I network types only) is matched, if it exists, using the searching order shown in [Table 2-22](#) and [Table 2-23](#).
 - If an exact `GTIx=0` GTT selector match is not found and an overlapped GTT selector is not found, the search fails.
- When the `unqgtsel` parameter value is `exactmatch`:
 - An exact `GTIx=0` GTT selector is matched, if it is in the database, using the searching order shown in [Table 2-22](#) and [Table 2-23](#).
 - If an exact `GTIx=0` GTT selector match is not found, the search fails.

The `unqgtsel` parameter value can be changed at any time. Non-overlapped GTT selectors can be provisioned regardless of the `unqgtsel` parameter value. When there are no overlapped GTT selectors in the database and only non-overlapped GTT selectors are in the database, the `exactmatch` value of the `unqgtsel` parameter is applied to the `GTIx=2` and `GTIx=4` GTT selectors. The system default value of the `unqgtsel` parameter is `bestmatch`.

XUDT UDT Conversion Feature

This feature provides for the conversion of these SCCP messages.

- An XUDT(S) message to a UDT(S) message
- A UDT(S) message to an XUDT(S) message

The conversion is performed on a service module card if the message was generated by the EAGLE, or on a LIM receiving the message if the message is MTP-routed. The conversion takes place just before the message is sent to the LIM that will be transmitting the message out of the EAGLE.

An SCCP Class 1 message that requires SCCP processing is processed by a service module card and then sent back to the receiving LIM to maintain sequencing. Message routing and the XUDT(S) UDT(S) conversion is performed on the receiving LIM in this case.

To configure the EAGLE to perform the XUDT UDT Conversion, these entities must be configured in the database.

- The XUDT UDT Conversion feature must be enabled and turned on – perform the [Activating the XUDT UDT Conversion Feature](#) procedure.

- Configure the destination point code of the XUDT(S) or UDT(S) message using either the `ent-dstn` or `chg-dstn` commands and specifying the `sccpmsgcnv` parameter. Perform one of these procedures in *Database Administration – SS7 User's Guide*.
 - Adding a Destination Point Code
 - Adding a Cluster Point Code
 - Adding a Network routing Point Code
 - Changing a Destination Point Code
 - Changing the Attributes of a Cluster Point Code

Table 2-24 shows the values of the `sccpmsgcnv` parameter.

Table 2-24 SCCPMSGCNV Parameter Values

SCCPMSGCNV Parameter Value	Parameter Description
NONE	No conversion is performed on messages for the destination. This is the default value of the <code>sccpmsgcnv</code> parameter if the <code>sccpmsgcnv</code> parameter is not specified with the <code>ent-dstn</code> command.
SXUDT2UDT	All segmented XUDT(S) and non-segmented XUDT messages for the destination are converted to UDT(S) messages.
XUDT2UDT	All non-segmented XUDT(S) messages for the destination are converted to UDT(S) messages. Segmented XUDT(S) messages are be converted to UDT(S) messages. All non-segmented XUDT(S) messages for the destination are converted to UDT(S) messages. Segmented XUDT(S) messages are not converted.
UDT2XUDT	All UDT(S) messages are converted to XUDT(S) messages.

UDT(S) to XUDT(S) Conversion

When converting a UDT(S) message to an XUDT(S) message, the changes shown in Table 2-25 are made to the message.

If the SCCP portion of the pre-converted message is longer that 270 bytes and the conversion results in the addition of the Hop Counter (1 byte) and Pointer to Optional Parameters (1 byte) fields causing the size of the SCCP portion to increase beyond a length of 272 bytes, then the segmentation of the message is not performed

Table 2-25 Parameter Values after UDT to XUDT or UDTS to XUDTS Conversion

UDT to XUDT Conversion		UDTS to XUDTS Conversion	
Parameter	Value after UDT to XUDT Conversion	Parameter	Value after UDTS to XUDTS Conversion
Message Type	XUDT (0x11)	Message Type	XUDTS (0x12)

Table 2-25 (Cont.) Parameter Values after UDT to XUDT or UDTS to XUDTS Conversion

UDT to XUDT Conversion		UDTS to XUDTS Conversion	
Parameter	Value after UDT to XUDT Conversion	Parameter	Value after UDTS to XUDTS Conversion
Protocol Class	Same as the pre-converted message.	Return Cause	Same as the pre-converted message.
Hop Counter	15, which is the maximum value.	Hop Counter	15, which is the maximum value.
Pointer to Called Party Address (CDPA)	Incremented from the pre-converted UDT message value by the size of the Pointer to Optional Parameters value (1 byte).	Pointer to Called Party Address (CDPA)	Incremented from the pre-converted UDTS message value by the size of the Pointer to Optional Parameters value (1 byte).
Pointer to Calling Party Address (CGPA)	Incremented from the pre-converted UDT message value by the size of the Pointer to Optional Parameters value (1 byte).	Pointer to Calling Party Address (CGPA)	Incremented from the pre-converted UDTS message value by the size of the Pointer to Optional Parameters value (1 byte).
Pointer to Data	Incremented from the pre-converted UDT message value by the size of the Pointer to Optional Parameters value (1 byte).	Pointer to Data	Incremented from the pre-converted UDTS message value by the size of the Pointer to Optional Parameters value (1 byte).
Pointer to Optional Parameters	0, since no optional parameters are present in a converted XUDT message.	Pointer to Optional Parameters	0, since no optional parameters are present in a converted XUDTS message.
Called Party Address (CDPA) Parameter	Same as the pre-converted message.	Called Party Address (CDPA) Parameter	Same as the pre-converted message.
Calling Party Address (CGPA) Parameter	Same as the pre-converted message.	Calling Party Address (CGPA) Parameter	Same as the pre-converted message.
Data	Same as the pre-converted message.	Data	Same as the pre-converted message.

XUDT(S) to UDT(S) conversion

When converting an XUDT(S) message to a UDT(S) message, the changes shown in [Table 2-26](#) are made to the message.

If the `sccpmsgcnv` value for the destination is `xudt2udt`, only non-segmented XUDT(S) messages are converted to UDT(S) messages while segmented XUDT(S) messages, that is, messages that contain the Segmentation parameter are routed to the destination without being converted.

If the `sccpmsgcnv` value for the destination is `sxudt2udt`, both segmented and non-segmented XUDT(S) messages are converted to UDT(S) messages.

Table 2-26 Parameter Values after XUDT to UDT or XUDTS to UDTS Conversion

XUDT to UDT Conversion		XUDTS to UDTS Conversion	
Parameter	Value after XUDT to UDT Conversion	Parameter	Value after XUDTS to UDTS Conversion
Message Type	UDT (0x09)	Message Type	UDTS (0x0a)
Protocol Class	Same as the pre-converted message.	Return Cause	Same as the pre-converted message.
Hop Counter	Dropped from the converted message.	Hop Counter	Dropped from the converted message.
Pointer to Called Party Address (CDPA)	Decrementd from the pre-converted (XUDT) message value by the size of the Pointer to Optional Parameters value (1 byte).	Pointer to Called Party Address (CDPA)	Decrementd from the pre-converted (XUDTS) message value by the size of the Pointer to Optional Parameters value (1 byte).
Pointer to Calling Party Address (CGPA)	Decrementd from the pre-converted (XUDT) message value by the size of the Pointer to Optional Parameters value (1 byte).	Pointer to Calling Party Address (CGPA)	Decrementd from the pre-converted (XUDTS) message value by the size of the Pointer to Optional Parameters value (1 byte).
Pointer to Data	Decrementd from the pre-converted (XUDT) message value by the size of the Pointer to Optional Parameters value (1 byte).	Pointer to Data	Decrementd from the pre-converted (XUDTS) message value by the size of the Pointer to Optional Parameters value (1 byte).
Pointer to Optional Parameters	Dropped from the converted message.	Pointer to Optional Parameters	Dropped from the converted message.
Called Party Address (CDPA) Parameter	Same as the pre-converted message.	Called Party Address (CDPA) Parameter	Same as the pre-converted message.
Calling Party Address (CGPA) Parameter	Same as the pre-converted message.	Calling Party Address (CGPA) Parameter	Same as the pre-converted message.
Data	Same as the pre-converted message.	Data	Same as the pre-converted message.
Segmentation – applies only to a segmented ANSI/ITU XUDT message.	Dropped from the converted message.	Segmentation – applies to a segmented ANSI/ITU XUDTS message.	Dropped from the converted message.
Importance – applies only to an ITU XUDT message.	Dropped from the converted message.	Importance – applies only to an ITU XUDTS message.	Dropped from the converted message.
INS – applies only to an ANSI XUDT message.	Dropped from the converted message.	INS – applies only to an ANSI XUDTS message.	Dropped from the converted message.
MTI – applies only to an ANSI XUDT message.	Dropped from the converted message.	MTI – applies only to an ANSI XUDTS message.	Dropped from the converted message.
End of Optional Parameters	Dropped from the converted message.	End of Optional Parameters	Dropped from the converted message.

Feature Interactions

STP/LAN

Even though messages are selected for copying for the STP/LAN feature according to their received, non-converted values, the actual messages that are copied will have been converted since the flag for the STP/LAN feature is set on the incoming signaling link and the actual copy occurs on the outgoing signaling link. This applies to all MTP-routed and SCCP messages that are generated by the EAGLE.

Database Transport Access - DTA

The XUDT UDT Conversion feature does not affect the DTA feature's functioning. The wrapper message is converted while the encapsulated message, which resides in the wrapper's data area, is not converted. The destination has to extract and convert the encapsulated message if it wishes to route the encapsulated message back to the EAGLE.

Integrated Sentinel/IMF

Incoming messages are selected for copying according to their received, non-converted values. Outgoing messages are selected for copying according to their converted values. This applies to both MTP-routed and SCCP messages that are generated by the EAGLE.

ANSI/ITU SCCP Conversion

The XUDT UDT Conversion feature is applied to MTP-routed SCCP messages that do not reach the service module cards before they are processed by the ANSI/ITU SCCP Conversion feature. For GT-routed messages and MTP-routed SCCP messages that are processed on the service module cards, the XUDT UDT conversion feature is applied after the ANSI/ITU SCCP conversion feature is performed on the message.

GTT Actions

The XUDT UDT Conversion feature is applied after the GTT Actions have been performed on the message. This means that if 4 DUPLICATE GTT actions are performed on the message, the XUDT UDT conversion feature is applied separately on all of the duplicated messages.

Upgrading from Global Title Translation (GTT) to Enhanced Global Title Translation (EGTT)

The Enhanced Global Title Translation (EGTT) feature provides enhancements to existing global title translation functions and automatically updates the database when the EGTT feature is turned on. Turning on the EGTT feature overrides the Global Title Translation (GTT) feature. This section provides a high-level summary of feature enhancements, the upgrade process, and upgrade considerations for the GTT and EGTT features.

 **Note:**

Before upgrading to and/or turning on a new feature, make sure you have purchased the feature to be upgraded to and/or turned on. If you are not sure whether you have purchased the feature, contact your Oracle Sales Representative or Account Representative.

Enhancements

The Enhanced Global Title Translation (EGTT) feature provides enhancements to existing global title translation functions:

- Increased number of selectors
- For ITU networks, addition of the translated subsystem number (SSN) in the called party address (CDPA) when octet is not equipped
- For ITU networks, inclusion of the originating point code (OPC) in the calling party address (CGPA)
- Capability to delete the global title (GT) in the called party address (CDPA)
- GTAs can be added offline to the EAGLE if the GTT set has not yet been assigned to a GTT selector.
- Aliasing is replaced by assigning multiple GTT selectors to an existing GTT set.
- Automatic upgrade of the database when the EGTT feature is turned on.

Upgrade Considerations

Enabling the Enhanced Global Title Translation (EGTT) feature overrides the Global Title Translation (GTT) feature. The GTT Selector, GTT Set, and GTA commands replace the Translation Type (-TT) and Global Title Translation (-GTT) commands. The SEAS equivalent of these commands will be maintained, mapping to ANSI with GTI of 2.

These commands can be executed when the EGTT feature is turned on, but will only produce CDGTA GTT sets and CDGTA GTT selectors.

- ENT-TT – Enter Translation Type
- CHG-TT – Change Translation Type
- DLT-TT – Delete Translation Type
- RTRV-TT – Retrieve Translation Type
- ENT-GTT – Enter Global Title Translation
- CHG-GTT – Change Global Title Translation
- DLT-GTT – Delete Global Title Translation
- RTRV-GTT – Retrieve Global Title Translation

If the point code that is specified with the `ent-gtt` or `chg-gtt` commands is an ANSI point code, only a CDGTA GTT selector entry that contains the translation type and the GTI value 2 will be shown in the `rtrv-gttset` output. If the point code that is specified with the `ent-gtt` or `chg-gtt` commands is an ITU point code, two CDGTA GTT selector entries will be shown in the `rtrv-gttset` output; one that contains the translation type and the GTI value 2 and another entry that contains

the translation type and the GTI value 4. The CDGTA GTT sets and CDGTA GTT selectors will contain the default values for the Advanced GTT feature parameters, shown in [Table 2-27](#).

Table 2-27 GTT Set and GTT Selector Advanced GTT Feature Default Parameter Values

SELID - none	CGSSN - no value	LSN - any
NP - dflt (if GTI=4, no value if GTI=2)	NAI - dflt (if GTI=4, no value if GTI=2)	SETTYPE - CDGTA

The following commands will be turned on when the EGTT feature is turned on:

- ENT-GTTSET – Enter GTT Set
- CHG-GTTSET – Change GTT Set
- DLT-GTTSET – Delete GTT Set
- RTRV-GTTSET – Retrieve GTT Set
- ENT-GTTSEL – Enter GTT Selector
- CHG-GTTSEL – Change GTT Selector
- DLT-GTTSEL – Delete GTT Selector
- RTRV-GTTSEL – Retrieve GTT Selector
- ENT-GTA – Enter Global Title Address
- CHG-GTA – Change Global Title Address
- DLT-GTA – Delete Global Title Address
- RTRV-GTA – Retrieve Global Title Address

GTT Set Commands

GTT Set commands are used to provision new sets for global title translation, linking GTT Selector (GTTSEL) and Global Title Address (GTA) commands. This set of commands provides greater flexibility when provisioning the type of messages that require global title translation. There are no SEAS equivalents for these commands.

GTT Selector Commands

GTT Selector commands are used to provision new selectors for global title translation. Together with the GTT Set commands, they replace the Translation Type (TT) commands, providing greater flexibility when provisioning the type of messages that require global title translation. There are no SEAS equivalents for these commands.

GTA Commands

GTA commands are used to provision GTTs using the new selectors for GTT. These commands replace the Global Translation Type (GTT) commands.

Upgrade Process

When existing systems are upgraded from the GTT feature to the EGTT feature, the GTT_TBT table is converted to the GTT Selector and GTT Set tables using the data

present in the GTT_TBT table. Set names are automatically picked for each entry in the GTT_TBT table, unless a TT Name is already provided. ANSI translation types are converted as is and given the GTI of 2. ITU translation types are converted to use two separate entries, one with the GTI of 2 and the other with the GTI of 4. During the conversion, DFLT (default) is assigned to the NP and NAI parameters for the GTI 4 entries. These values can then be changed to more specific values with the `ent-gttset` command.

Aliases versus Selectors

One of the important differences between the GTT and EGTT features is the more flexible creation and use of “aliases”, which are replaced by selectors in the EGTT feature. Global title translation data can be built before bringing it into service and the service to existing global titles remains uninterrupted by allowing selector values to be changed instead of having to be deleted.

The flexibility in assigning selectors to sets of global title translation data is shown in [Table 2-28](#) in the reuse of the selector for `setint000`. In this example, you can break up GTT selectors into more specific entries (other than `dflt`) without having to delete the entire GTT data set for a selector.

GTT data can be built without being used until a link is added to a selector (specifying `GTTSN` with the `CHG-GTTSEL` command). At the same time, selectors can be changed without affecting existing global titles.

[Table 2-28](#) shows an alias entry, `GTII=4, TT=0, NP=E164, NAI=INTL`, added to the same GTT set `setint000` as several other selectors.

Table 2-28 Use of Aliases in GTT Selector Table

GTIA	TT	NP	NAI	GTTSN
2	1	---	---	setans001
2	9	---	---	lidb
2	10	---	---	t800
2	253	---	---	t800
GTII	TT	NP	NAI	GTTSN
4	0	DFLT	DFLT	setint000
2	0	---	---	setint000
4	9	DFLT	DFLT	IMSI
2	9	---	---	IMSI
4	18	DFLT	DFLT	IMSI
2	18	---	---	IMSI
4	0	E164	INTL	setint000

SCCP Overview

The signaling connection control part (SCCP) is divided into two functions:

- SCCP Routing Control
- SCCP Management

[Figure 2-31](#) shows the relationship of these two functions.

Figure 2-31 Logical View of SCCP Subsystems

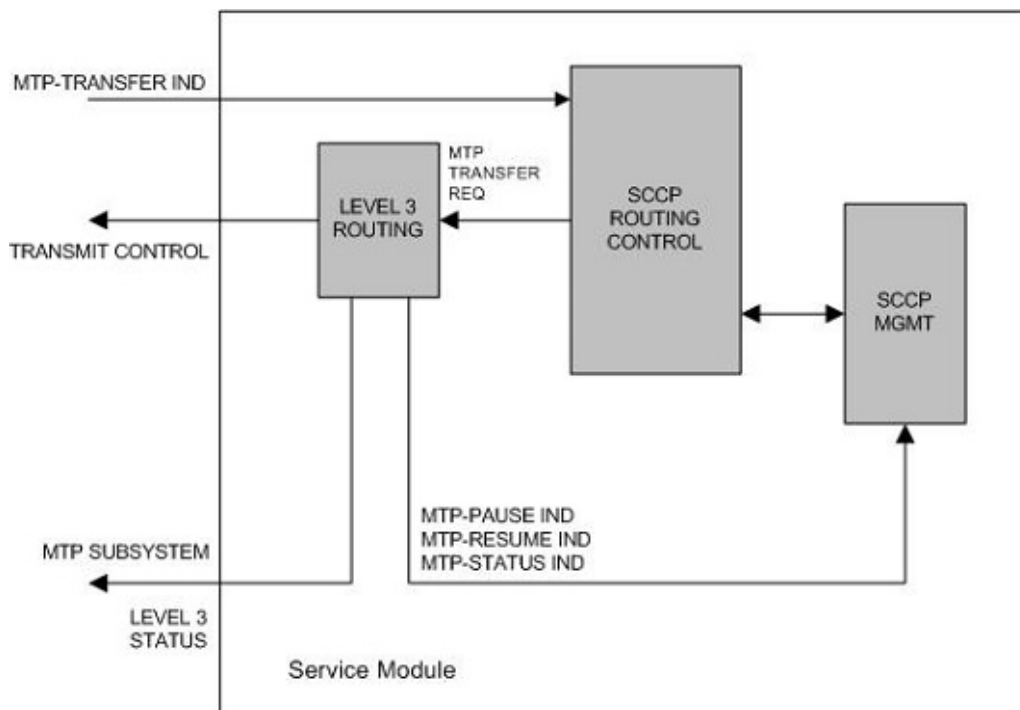

SCCP Routing Control

SCCP routing control receives messages from other nodes in the network via the MTP-Transfer indication.

A load balancing function assigns each LIM to a service module to distribute the SCCP traffic among the available service modules. When a LIM receives an SCCP message that is destined for the EAGLE, it sends the message to the service module assigned to that LIM. If that LIM does not have a service module assigned to it, the LIM discards the SCCP message. If no service modules are equipped or available, the SCCP message is discarded and the LIM transmits a User Part Unavailable MSU to the sending node.

When a LIM receives an SCCP message that is destined for another node, the LIM performs MTP routing and the SCCP message is not sent to the service module.

[Figure 2-32](#) shows the message flow for an SCCP message destined for the EAGLE and for an SCCP message destined for another node.

Figure 2-32 SCCP Message Flow through the EAGLE

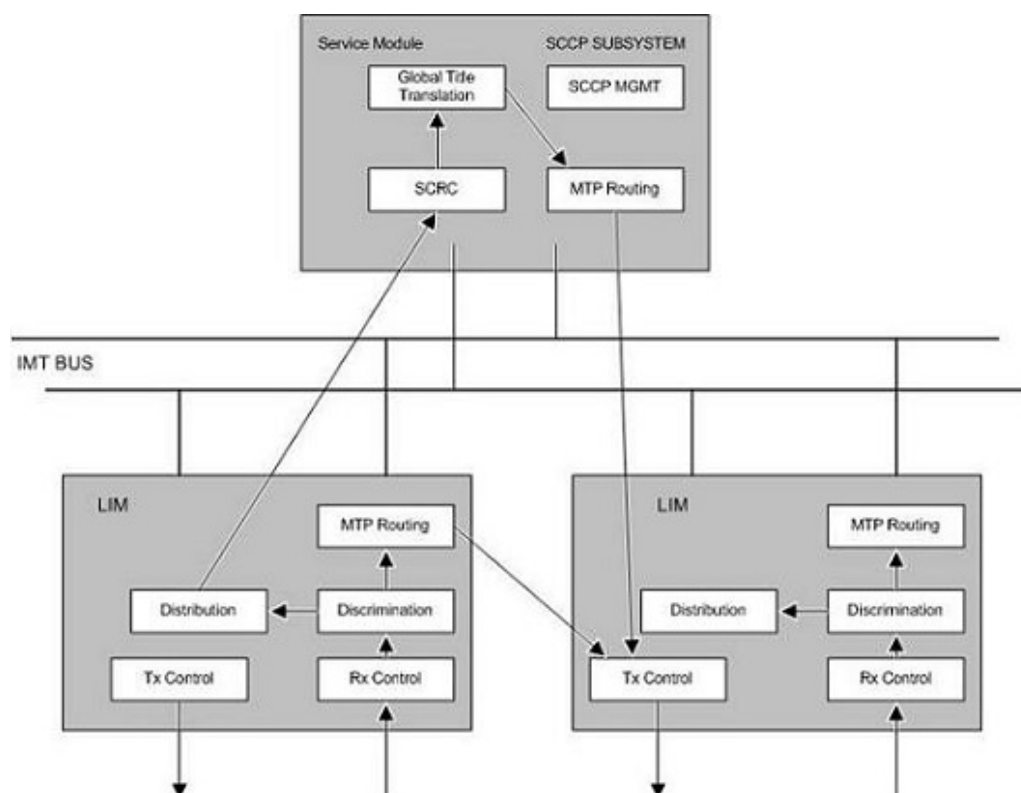

When SCCP receives a message from MTP, it checks the routing indicator in the called party address. There are two types of routing shown by the called party address routing indicator.

1. Subsystem (ssn) – This indicates the message is destined for a subsystem at this node. For the EAGLE, the only valid local subsystem is SCCP management (ssn = 1). If the LNP feature is enabled, the EAGLE contains an LNP subsystem which can be numbered from 2 to 255. The LNP subsystem number can be configured with the "Adding a Subsystem Application" procedure in *Administration and LNP Feature Activation Guide* for ELAP.
2. Global Title (gt) – This indicates that global title translation is required. The EAGLE performs the translation, determines the new DPC for the message, and routes the message to that DPC.

Global Title Translation Function

Interaction with the Global Title Translation (GTT) Feature

The SCCP routing function control uses two tables to perform global title translation: the translation type table and the global title translation table. [Figure 2-33](#) shows how these tables are organized.

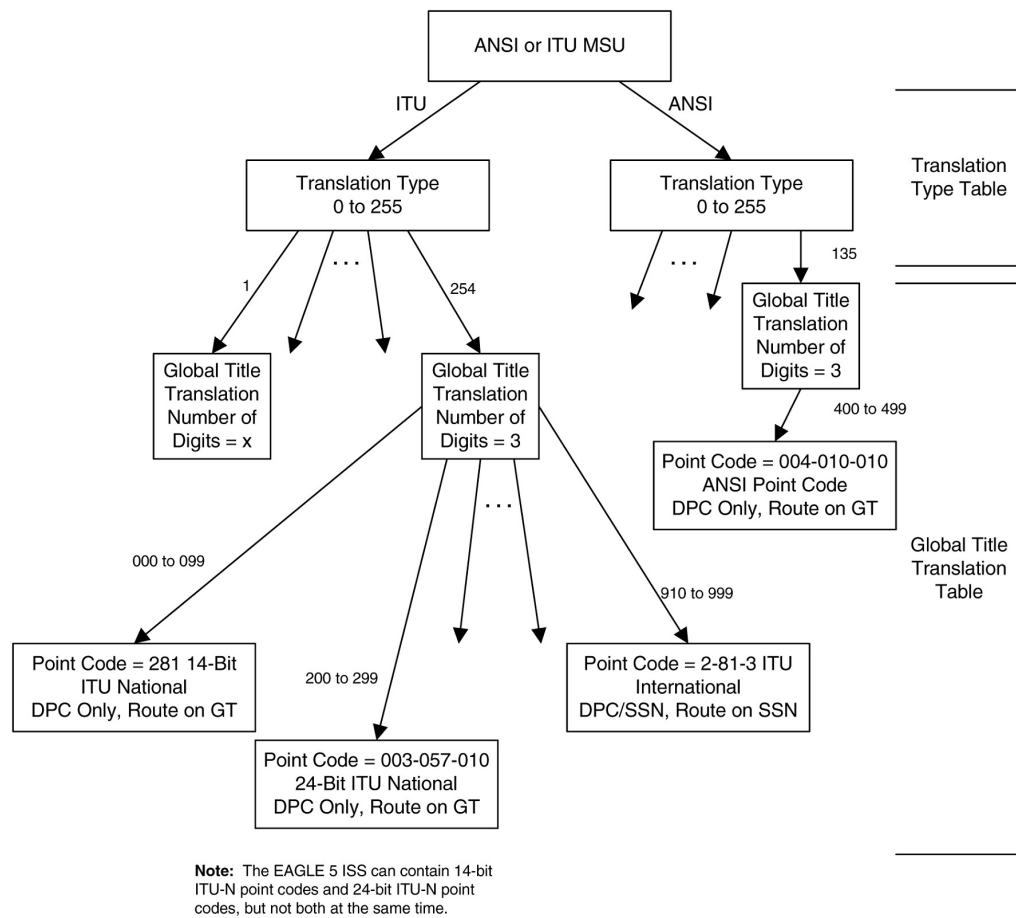
Figure 2-33 Example of Using Translation Type and Global Title Translation Tables

The translation type table is used by SCCP to determine which global title translation table to access. This allows translation tables to be customized to the type of translations that need to be performed, (for example, 6 digit, 800, etc.). The translation block is accessed by using the translation type in the called party address and the network type of the MSU (ANSI or ITU) as an index within the table. Each entry points to the start of a global title translation table.

The translation type table is configured by the `ent-tt` command. For more information on the `ent-tt` command, refer to the *Commands Manual*.

Each translation type entry in the translation type table contains these fields:

- name of translation type (optional) (8 bytes)
- number of digits (1 byte)
- alias translation type (2 bytes)
- pointer to translation table (4 bytes)
- network type (1 byte)

The global title translation table is used by SCCP to map a global title address to an SS7 network address so that the SCCP message can be routed to its destination. The

global title translation table is configured by the `ent-gtt` or `chg-gtt` commands. For more information on the `ent-gtt` or `chg-gtt` commands, refer to *Commands User's Guide*.

Each global title translation entry in the global title translation table contains these fields:

- Global title address low value (up to 21 digits) (11 bytes)
- Global title address high value (up to 21 digits) (11 bytes)
- Destination point code (may be an ANSI, ITU national, or ITU international point code) (4 bytes)
- Field that contains either a subsystem number (for route on SSN translation results only) (1 byte) or a new translation type (for new GT translation result only) (1 byte)
- Translation result consisting of one of these conditions (1 byte):
 - Translate on the DPC only, route on GT (subsequent global title translation required)
 - Translate on the DPC only, route on SSN
 - Translate on the DPC and SSN, route on GT (subsequent global title translation required)
 - Translate on the DPC and SSN, route on SSN
 - Translate on new GT (subsequent global title translation required)

The translation result determines what data in the message is replaced. The DPC in the routing label is always replaced after the SCCP message is translated. If a point code exists in the called party address, it is also replaced. The subsystem number or the translation type in the called party address can be replaced, but neither have to be replaced. The routing indicator in the called party address can be set to “route on SSN,” or can remain set to “route on GT.” [Table 2-29](#) shows which fields in the MSU are modified for each translation result.

Table 2-29 MSU Fields Modified by Global Title Translation

Translation Result	Routing Label DPC Replaced	CDPA SSN Replaced	CDPA Routing Indicator Replaced	CDPA Translation Type Replaced	CDPA PC Replaced (if it already exists)
Translate on DPC only, route on GT	yes	no	no – remains set to route on GT	Can be replaced (See note)	yes
Translate on DPC only, route on SSN	yes	no	yes – set to route on SSN	no	yes
Translate on DPC and SSN, route on GT	yes	yes	no – remains set to route on GT	no	yes
Translate on DPC and SSN, route on SSN	yes	yes	yes – set to route on SSN	no	yes

Table 2-29 (Cont.) MSU Fields Modified by Global Title Translation

Translation Result	Routing Label DPC Replaced	CDPA SSN Replaced	CDPA Routing Indicator Replaced	CDPA Translation Type Replaced	CDPA PC Replaced (if it already exists)
Translate on new GT	yes	no	no – remains set to route on GT	yes	yes

 **Note:**

The CDPA translation type can be replaced when translating on the DPC only and routing on GT only if the ANSI/ITU SCCP Conversion feature is enabled. If the ANSI/ITU-China SCCP Conversion feature is not enabled when translating on the DPC only and routing

Route on GT

The “Route on GT” translate indicator (subsequent global title translation required) represents the need for a second translation after the initial one.

This need is indicated by the routing bit being set to “route on GT.” In this case, the remote point code table is not checked for status of the subsystem number. Instead, the MSU is sent directly to MTP for routing to the translated point code. If the point code is inaccessible, the MSU is discarded, and a UDTS (unitdata service) message is generated if the return on error option is set.

Interaction with the Enhanced Global Title Translation (EGTT) Feature

The SCCP routing function control uses three tables to perform global title translation: the GTT Selector table, the GTT Set table, and the global title address (GTA) table. The SCCP use the GTT Set table together with the GTT Selector table to determine which GTA table to access. This allows translation tables to be customized with the type of translations that need to be performed.

Figure 2-34 Example of Using GTT Selector, GTT Set, and GTA Tables

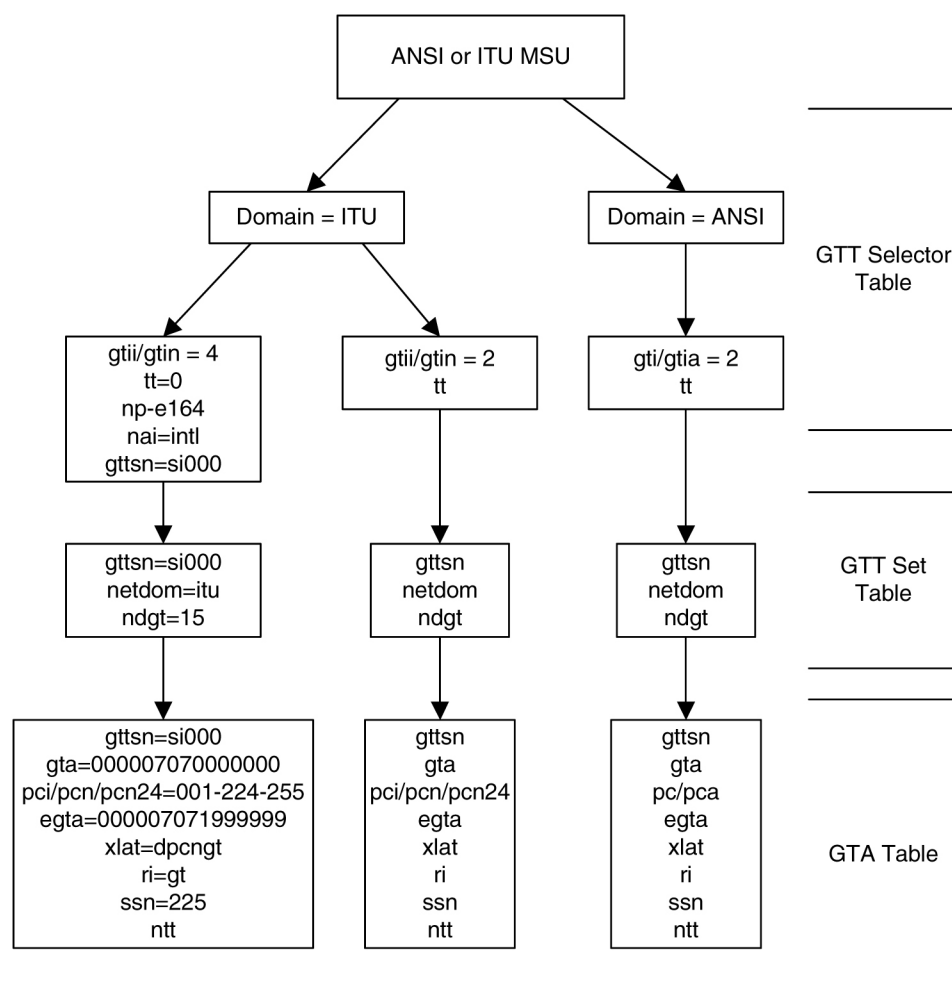

Note: The EAGLE 5 ISS can contain 14-bit ITU-N point codes and 24-bit ITU-N point codes, but not both at the same time.

The GTT Set table is configured by the `ent-gttset` command; the GTT Selector table is configured by the `ent-gttset1`. For more information on this command, refer to *Commands User's Guide*.

Each GTT Set table contains these fields:

- GTT Set name
- Network domain name
- Number of digits

Each GTT Selector table contains these fields:

- GTT Set name
- The global title indicator (GTI). The GTI defines the domain as
 - `gti` and `gtia` (ANSI) with GTI=2
 - `gtii` (ITU international) with GTI=2 or GTI=4, and

- `gtin` (ITU national) with GTI=2 or GTI=4.
The global title indicator is made up of the:
 - * name of the global title translation type (TT); and the
 - * numbering plan (NP) or numbering plan value (NPV) if GTI=4; and the
 - * nature of address indicator (NAI) or nature of address indicator value (NAIV) if GTI=4.

 **Note:**

Both the numbering plan and nature of address indicator parameters can be specified by supplying either a mnemonic or an explicit value. At no time may both the mnemonic and the explicit value be specified at the same time for the same parameter.

The GTA table is used by the SCCP to map a global title address to an SS7 network address so that the SCCP message can be routed to its destination. The GTA table is configured by the `ent-gta` or `chg-gta` commands. For more information on the `ent-gta` or `chg-gta` commands, refer to *Commands User's Guide*.

Each global title address entry in the GTA table contains these fields:

- GTT Set name
- Start of the global title address (up to 21 digits)
- End of the global title address (up to 21 digits)
- Destination point code (may be an ANSI, ITU national, or ITU international point code)
- Translated subsystem number
- Translate indicator
- Cancel Called Global Title indicator
- Routing indicator (translation results)
 - Translate on the DPC only, route on GT (subsequent global title translation required)
 - Translate on the DPC only, route on SSN
 - Translate on the DPC and SSN, route on GT (subsequent global title translation required)
 - Translate on the DPC and SSN, route on SSN
 - Translate on new GT (subsequent global title translation required)

The translation result determines what data in the message is replaced. The DPC in the routing label is always replaced after the SCCP message is translated. If a point code exists in the called party address, it is also replaced. The subsystem number or the translation type in the called party address can be replaced, but neither have to be replaced. The routing indicator in the called party address can be set to "route on SSN" or can remain set to "route on GT." [Table 2-30](#) shows which fields in the MSU are modified for each translation result.

Table 2-30 MSU Fields Modified by Enhanced Global Title Translation

Translation Result	Routing Label DPC Replaced	CDPA SSN Modified	CDPA Routing Indicator Replaced	CDPA Translation Type Replaced	CDPA PC Replaced (if it already exists)	GT Deleted
Translate on DPC only, route on GT	yes	no	no – remains set to route on GT	Can be replaced (See note)	yes	no
Translate on DPC only, route on SSN	yes	no	yes – set to route on SSN	no	yes	yes
Translate on DPC and SSN, route on GT	yes	yes	no – remains set to route on GT	no	yes	no
Translate on DPC and SSN, route on SSN	yes	yes	yes – set to route on SSN	no	yes	yes
Translate on new GT	yes	no	no – remains set to route on GT	yes	yes	no

 **Note:**

The CDPA translation type can be replaced when translating on the DPC only and routing on GT only if the ANSI/ITU SCCP Conversion feature is enabled. If the ANSI/ITU SCCP Conversion feature is not enabled when translating on the DPC only and routing on GT, the CDPA translation type cannot be replaced.

Route on GT

The “Route on GT” translate indicator (subsequent global title translation required) represents the need for a second translation after the initial one.

This need is indicated by routing being set to “route on GT.” In this case, the remote point code table is not checked for status of the subsystem number. Instead, the MSU is sent directly to MTP for routing to the translated point code. If the point code is inaccessible, the MSU is discarded, and a UDTS (unitdata service) message is generated if the return on error option is set.

1. If an MSU enters the EAGLE and more information is needed to route the MSU (route-on-gt), the signaling connection control part (SCCP) of the SS7 protocol sends a query to a service database to obtain the information. The EAGLE uses the Enhanced Global Title Translation (EGTT) feature of SCCP to determine which service database to send the query messages to.

2. The EGTT feature uses global title information (GTI) to determine the destination of the MSU. The GTI is contained in the called party address (CDPA) field of the MSU. For `gti=4`, the GTI is made up of the Numbering Plan (NP), Nature of Address Indicator (NAI), and Translation Type (TT) selectors.
3. The EGTT feature does a Selector Table lookup based on the selector information extracted. If a match is found, then EGTT is performed on the message. If no match is found in the selector table for this entry, then EGTT performs SCRC error handling on the message.
4. The EGTT feature decodes the GTA digits and compares the GTA length with the fixed number of digits specified in the `ndgt` parameter of the `ent-gtt sel` command and expected by the translator. If the number of digits received in the CDPA is more than the number of digits specified in the `ndgt` parameter, then the EGTT feature considers the leading `ndgt` digits to perform the translation. If the number of digits received in the CDPA is less than the number of digits specified in the `ndgt` parameter, then EGTT discards the message and initiates the SCRC error handling.

 **Note:**

If the optional Variable-length Global Title Translation (VGTT) feature is enabled, the EGTT feature allows enhanced global title translation on global title addresses of varying length. For more information about this feature, refer to the [Variable-length Global Title Translation Feature](#) section.

5. The EGTT feature uses the number of digits received in the CDPA to perform the Translation Table lookup. If a match is found in the database, the translation data associated with this entry is used to modify the message and the resultant message is routed to the next node. If the CDPA GTAI digits are not found in the database, then standard SCRC error handling is performed on this message. Refer to [Figure 2-35](#).

Figure 2-35 EGTT Process

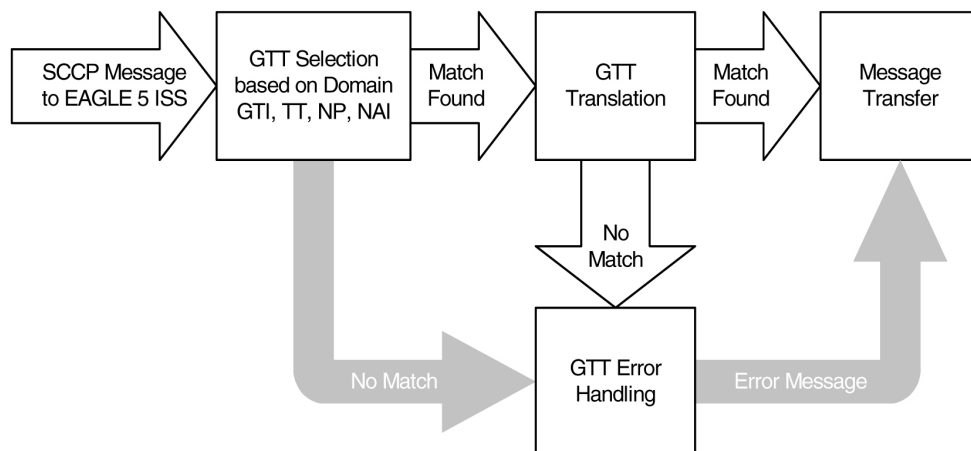

Route on SSN

The “Route on SSN” translate indicator indicates that the point code and SSN is the final destination for the MSU. In this case, the remote point code table is checked to

determine the status of the point code and the subsystem number. If the point code or subsystem is unavailable and a backup point code and subsystem is available, the MSU is routed to the backup. Routing to the point codes or subsystems is based upon the data in the remote point code table. There can be up to 31 backup point codes and subsystems assigned to the primary point code and subsystem, thus forming a mated application (MAP) group.

The routing to these backup point codes is based on the relative cost values assigned to the backup point codes. The lower the relative cost value is, the higher priority the point code and subsystem has in determining the routing when the primary point code and subsystem is unavailable. The relative cost value of the primary point code and subsystem is defined by the `rc` parameter of the `ent-map` or `chg-map` commands. The relative cost value of backup point codes and subsystems is defined by the `materc` parameter of the `ent-map` or `chg-map` commands.

There are four routing possibilities for a point code and subsystem number.

- Solitary – there is no backup point code and subsystem for the primary point code and subsystem.
- Dominant – a group of backup point codes and subsystems exists for the primary point code and subsystem. All the point codes and subsystems in this group have different relative cost values, with the primary point code and subsystem having the lowest relative cost value. All traffic is routed to the primary point code and subsystem, if it is available. If the primary point code and subsystem becomes unavailable, the traffic is routed to highest priority backup point code and subsystem that is available. When the primary point code and subsystem becomes available again, the traffic is then routed back to the primary point code and subsystem.
- Load sharing – a group of backup point codes and subsystems is defined for the primary point code and subsystem. All the point codes and subsystems in this group have the same relative cost value. Traffic is shared equally between the point codes and subsystems in this group.
- Combined dominant/load sharing – a group that is a combination of the dominant and load sharing groups. A combined dominant/load shared group is a group that contains a minimum of two RC (relative cost) values that are equal and a minimum of one RC value that is different. The traffic is shared between the point codes with the lowest relative cost values, where the relative cost value is considered the relative cost associated with the point code and subsystem of the global title translation and not the actual lowest relative cost in the MAP set. If these point codes and subsystems become unavailable, the traffic is routed to the other point codes and subsystems in the group and shared between these point codes and subsystems.

For each point code, the user has the option of setting the `mrc` (message reroute on congestion) parameter. The `mrc` parameter, as well as the other data in the remote point code table, is set with the `ent-map` or `chg-map` commands. For more information on the `ent-map` or `chg-map` commands, refer to *Commands User's Guide*.

If the `mrc` parameter is set to `no`, and the primary point code is congested, the MSU is discarded, even if a backup point code and subsystem is available. If the `mrc` parameter is set to `yes`, and the primary point code is congested, the MSU is routed to the backup point code and subsystem, if it is available. The default value for the `mrc` parameter is `no` if the primary point code is an ITU national or international point code, and `yes` if the primary point code is an ANSI point code.

SCCP Management

SCCP management is responsible for rerouting signaling traffic when network failures or congestion conditions occur.

MTP network management informs SCCP of any changes in point code routing status. Changes in subsystem status are updated by using the subsystem allowed and subsystem prohibited procedures of SCCP management.

SCCP management updates the status of point codes and subsystems. Also, SCCP management broadcasts subsystem allowed and prohibited messages to concerned nodes. The EAGLE supports a broadcast list of up to 96 concerned nodes for each subsystem. This list is configured with the `ent-cspc` command. For more information on the `ent-cspc` command, refer to *Commands User's Guide*.

For ANSI primary point codes, if the backup point code and subsystem are adjacent when the subsystem becomes prohibited or allowed, these messages are sent to the backup subsystem before routing any messages to it:

- Subsystem prohibited or allowed message
- Subsystem backup routing or subsystem normal routing message

These messages are not required in ITU networks, so if the primary point code is either an ITU national or international point code, these messages are not sent.

Translation Type Mapping

Certain SCCP messages contain a called party address parameter that contains a translation type field. The translation type field indicates the type of global title processing the EAGLE must perform. The values used within any particular network may be different than the standardized values that are defined for internetwork applications.

The translation type mapping feature maps standardized internetwork translation type values to intranetwork translation type values used within any particular network. This feature also maps intranetwork translation type values to standardized internetwork translation type values.

The only SCCP messages that are affected by translation type mapping are UDT and XUDT messages, received or transmitted, whose global title indicator is 0010 (ANSI/ITU) or 0100 (ITU). The translation type will be modified for these messages regardless of whether the destination point code in the MTP routing label is an EAGLE point code and regardless of the SCCP CdPA routing indicator value. Other messages that contain the called party address parameter are not affected. For example, UDTS messages are assumed to be MTP routed and need not be examined. XUDTS messages are either MTP routed or use one translation type value indicating global title to point code translation and should not be mapped.

Translation type mapping is performed on each LIM in the linkset. Incoming translation type mapping is performed on linksets bringing messages into the EAGLE, and is performed before the global title translation function, the gateway screening function. Outgoing translation type mapping is performed on linksets carrying messages out of the EAGLE to other destinations, and is performed after the global title translation function, the gateway screening function.

When outgoing translation type mapping is configured and the MSU must be re-routed due to a changeback or signaling link failure, the re-routed MSU could be double

mapped. This is a limitation since re-screening or re-translating (with possible incorrect results) can occur by performing the global title translation and gateway screening functions on the mapped MSU. Figure 2-36 shows an example of a translation type that is double mapped.

Figure 2-36 An Example of Double Translation Type Mapping

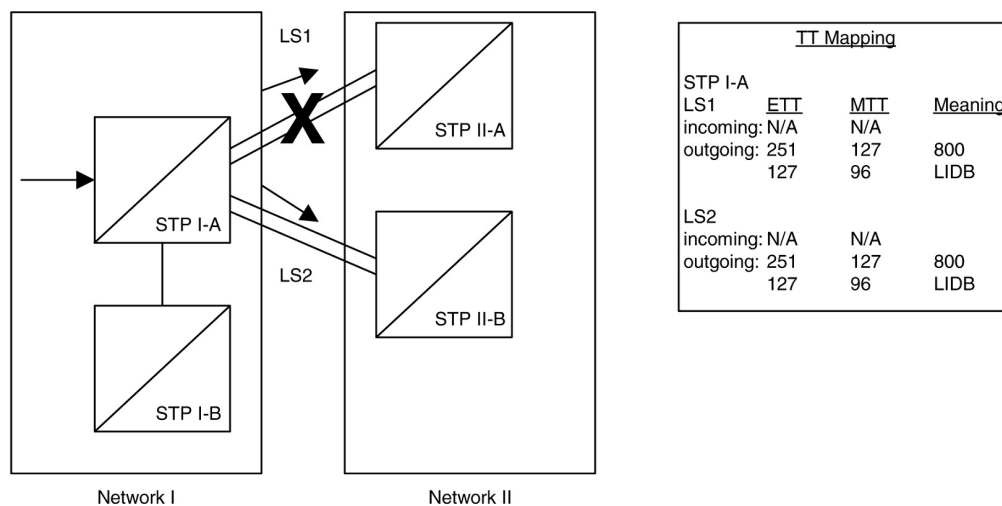

In Figure 2-36, MSUs on the outgoing linkset LS1 containing the existing translation type (ETT) 251 are mapped to translation type 127 (MTT). MSUs on the outgoing linkset LS2 containing the existing translation type 127 are mapped to translation type 96. Linkset LS1 fails and the traffic is re-routed on linkset LS2. Any outgoing traffic that was on linkset LS1 containing the translation type 251 has been changed to translation type 127. When this traffic is re-routed on linkset LS2, the translation type of the messages that was changed to 127 remains 127 and is not changed back to 251. When the messages are sent over linkset LS2, the existing translation type 127 is changed to translation type 96. This is an example of double mapping a translation type. In this example, the messages leaving network 1 on linkset LS1 were mapped to translation type 127, an “800” translation type. Because of double mapping, that translation type was changed to 96, a “LIDB” translation type. These messages can be routed to the wrong subsystem database; or if gateway screening is configured to screen for these messages, these messages could be discarded before they leave network 1, and network 2 would never receive them.

To help prevent this from happening, configure the incoming traffic on the linkset to map the mapped translation type of the outgoing traffic on that linkset (MTT) to the existing translation type for outgoing traffic on that linkset (ETT). In this example, for incoming traffic on linksets LS1 and LS2, map the existing translation type 127 (the mapped translation type for outgoing traffic on these linksets) to the mapped translation type 251 (the existing translation type for outgoing traffic on these linksets). When linkset LS1 fails, the incoming messages on linkset LS2 containing translation type 127, including those that were mapped to 127 on linkset LS1 and are now being rerouted, are now mapped to translation type 251. When these messages become outgoing messages on linkset LS2, those messages containing translation type 251 are mapped to translation type 127 instead of 96. These messages can then continue to be routed to the proper subsystem database. If gateway screening is configured to screen for and discard messages with translation type 96, the rerouted messages are not effected by the results of the translation type mapping.

If the database transport access feature is being used, and the MSU encapsulated by the gateway screening redirect function contains a translation type that must be mapped on an incoming basis, the encapsulated MSU contains the mapped translation type. The translation type of the new MSU is obtained from the gateway screening redirect table.

The EAGLE supports 64 translation type mappings for each linkset. This includes both incoming and outgoing translation type mappings. EAGLE supports translation type mapping entries for 255 linksets. The maximum number of translation type mappings that can be configured in the EAGLE is 16,320.

The translation type mapping information is configured in the database using the `ent-ttmap`, `chg-ttmap`, `dlt-ttmap`, and `rtrv-ttmap` commands.

GTT Configuration

The following procedures describe the steps needed to add, remove, or change global title translation (GTT) data in the database.



Note:

The Global Title Translation (GTT) feature must be purchased before enabling the features with the `chg-feat:gtt=on` command. If you are not sure whether you have purchased the GTT feature, contact your Oracle Sales Representative or Account Representative.

The items configured in this section are:

- Service modules
- Translation type mapping
- Concerned signaling point codes
- Mated applications
- Mated relay nodes.
- GT conversion table entries for the ANSI/ITU SCCP Conversion feature
- Loopsets for the SCCP Loop Detection feature.
- GT modification identifiers for the Advanced GT Modification feature.

To configure the global title translation feature, translation types and global title translations must also be configured. The procedures to configure translation types and global title translations are located in the [Global Title Translation \(GTT\) Configuration](#) section.

The procedures shown in this chapter use a variety of commands. If more information on these commands is needed, refer to *Commands User's Guide* to find the required information.

There must be SS7 routes to the nodes referenced by the global title translation entities in the database. Perform one of the Adding a Route procedures in *Database Administration – SS7 User's Guide* to configure these routes.

The following is a brief description of the global title translation entities. These global title translation entities must be configured in the order that they are shown.

1. The GTT feature must be turned on with the `chg-feat:gtt=on` command. Verify this with the `rtrv-feat` command.

 **Note:**

Once the Global Title Translation (GTT) feature is enabled with the `chg-feat` command, it cannot be disabled.

The GTT feature must be purchased before enabling this feature. If you are not sure whether you have purchased the GTT feature, contact your Oracle Sales Representative or Account Representative.

2. A service module must be configured in the database with the `ent-card` command. A service module can be one of these cards: DSM (E5-SM4G/E5-SM8G-B), or SLIC. The DSM card is specified with the `type=dsm` and `appl=vsccp` parameters of the `ent-card` command. The SLIC card is specified with `type=dsm` (in the odd numbered card slots) or `type=slic` (in the even numbered card slots), and `appl=vsccp` parameters of the `ent-card` command. Refer to the [Adding a Service Module](#) procedure for the required cards. The card configuration can be verified with the `rtrv-card` command.
3. A translation type must be defined in the database. Verify this with the `rtrv-tt` command. If the necessary translation types are not in the database, add them with the `ent-tt` command. The translation type is used by the `ent-gtt` command and defines the length of the global title address. If the Variable-length Global Title Translation (VGTT) feature is being used, it must be enabled with the `chg-feat:vgtt=on` command. Verify this with the `rtrv-feat` command. Refer to the [Variable-length Global Title Translation Feature](#) section for more information on this feature.

 **Note:**

Once the Variable-length Global Title Translation (VGTT) feature is enabled with the `chg-feat` command, it cannot be disabled.

The VGTT feature must be purchased before enabling this feature. If you are not sure whether you have purchased the VGTT feature, contact your Oracle Sales Representative or Account Representative.

4. The translation type can be mapped to another translation type. This is a function of the translation type mapping feature. The translation type mapping feature maps standardized internetwork translation type values to intranetwork translation type values used within any particular network. This feature also maps intranetwork translation type values to standardized internetwork translation type values. Enter the `rtrv-ttmap` command to verify that the necessary translation type mapping information is in the database. Enter the necessary translation type mapping information in the database using the `ent-ttmap` command.
5. The concerned signaling point code broadcast groups must be defined in the database. These groups define the point codes that receive subsystem allowed and subsystem prohibited status messages about a particular global title

translation node. These messages are broadcast from SCCP management. Verify that these groups are in the database with the `rtrv-cspc` command. If these groups are not in the database, add them with the `ent-cspc` command.

6. The mated applications must be defined in the database. The mated applications are the point codes and subsystem numbers of the service databases along with parameters describing the routing between replicated pairs of service databases. Verify the mated application information in the database with the `rtrv-map` command. If the necessary mated application information is not in the database, add the necessary information with the `ent-map` command.
If the XMAP Table Expansion feature is to be used to increase the number of mated application entries in the mated application table to either 2000 or 3000 entries, the XMAP Table Expansion feature must be enabled with the `enable-ctrl-feat` command. Verify the status of the XMAP Table Expansion feature with the `rtrv-ctrl-feat` command.

The mated applications provide load sharing of the traffic between replicated pairs of service databases. The Flexible GTT Load Sharing feature provides more flexible load sharing capabilities for final global title translations (global title translation containing the routing indicator value SSN) than the mated applications can provide without the Flexible GTT Load Sharing feature enabled. With this feature enabled, MAP sets are provisioned. These MAP sets are assigned to global title translations. Refer to [Flexible Final GTT Load Sharing](#) for more information on using the Flexible GTT Load Sharing feature with mated applications.

Load sharing based on the transaction parameters of the message can be performed if the Transaction-Based GTT Load Sharing feature is enabled and turned on. Refer to the [Transaction-Based GTT Load Sharing](#) section for more information on using the Transaction-Based GTT Load Sharing feature.

Load sharing based on the weight assigned to an individual entities in a load sharing MAP group can be performed if the Weighted GTT Load Sharing feature is enabled and turned on. Refer to the [Weighted GTT Load Sharing](#) section for more information on using the Weighted GTT Load Sharing feature.

7. The mated relay node groups can be defined in the database if the Intermediate GTT Load Sharing feature is to be used. Verify this with the `rtrv-mrn` command. If the necessary global title translation information is not in the database, add it with the `ent-mrn` command.
The Intermediate GTT Load Sharing (IGTTLS) feature must be enabled with the `enable-ctrl-feat` and `chg-ctrl-feat` commands. Verify this with the `rtrv-ctrl-feat` command. Refer to the [Intermediate GTT Load Sharing Feature](#) section for more information on this feature.

The Flexible GTT Load Sharing feature provides more flexible load sharing capabilities for intermediate global title translations (global title translation containing the routing indicator value GT) than the Intermediate GTT Load Sharing feature can provide. With this feature enabled, MRN sets are provisioned. These MRN sets are assigned to global title translations. Refer to [Flexible Intermediate GTT Load Sharing](#) for more information on using the Flexible GTT Load Sharing feature with mated relay node groups.

Load sharing based on the transaction parameters of the message can be performed if the Transaction-Based GTT Load Sharing feature is enabled and turned on. Refer to the [Transaction-Based GTT Load Sharing](#) section for more information on using the Transaction-Based GTT Load Sharing feature.

Load sharing based on the weight assigned to an individual entities in a load sharing MRN group can be performed if the Weighted GTT Load Sharing feature is enabled and turned on. See the [Weighted GTT Load Sharing](#) section for more information on using the Weighted GTT Load Sharing feature.

8. The global title translation data must be defined in the database. This data is used to determine the destination of the service database that needs to be queried for additional routing information. Verify this with the `rtrv-gtt` command. If the necessary global title translation information is not in the database, add it with the `ent-gtt` command.

If the Advanced GT Modification feature is being used, it must be enabled with the `enable-ctrl-feat` command. Verify this with the `rtrv-ctrl-feat` command. Refer to the [Advanced GT Modification Feature](#) section for more information on this feature.

 **Note:**

Once the Advanced GT Modification feature is enabled, it cannot be disabled.

If the XGTT Table Expansion feature is to be used to increase the number of mated application entries in the mated application table to either 400,000 or 1,000,000 entries, the XGTT Table Expansion feature must be enabled with the `enable-ctrl-feat` command. Verify the status of the XGTT Table Expansion feature with the `rtrv-ctrl-feat` command.

The ANSI/ITU SCCP Conversion feature provides a means to perform SCCP conversion between ANSI MSUs and ITU MSUs. To perform this conversion, the ANSI/ITU SCCP Conversion feature must be enabled with the `enable-ctrl-feat` command, and turned on with the `chg-ctrl-feat` command. Verify the status of the ANSI/ITU SCCP Conversion feature with the `rtrv-ctrl-feat` command. Entries must be also configured in the GT conversion table with the `ent-gtcnv` command. The content of the GT conversion table can be verified with the `rtrv-gtcnv` command.

Decimal digits (0-9) or hexadecimal digits (0-9, a-f, A-F) can be specified for these items that are assigned to the global title translation entry.

- The global title address (`gta` and `egta`) values
- Entries in the GT conversion table
- The prefix (`npds`) and suffix (`nsds`) values in the GTMOD identifier that is assigned to the global title translation entry.

Hexadecimal digits can be specified only if the Hex Digit Support for GTT feature is enabled. Verify the status of the Hex Digit Support for GTT feature with the `rtrv-ctrl-feat` command. Refer to the [Hex Digit Support for GTT](#) section for more information on this feature.

The SCCP Loop Detection feature provides a method for detecting SCCP looping. With this feature enabled, loopsets are provisioned. These loopsets are assigned to Global Title Translations. See the [SCCP Loop Detection](#) section for more information on using the SCCP Loop Detection feature with Global Title Translations.

EGTT Configuration

In addition to the items shown in the [GTT Configuration](#) section, some or all of these items must be configured to support the EGTT feature.

- GTT sets
- GTT selectors
- Global title address information
- GTT action sets
- GTT action per-path measurements

The procedures to configure these items are located in the [Enhanced Global Title Translation \(EGTT\) Configuration](#) section.

The translation type (`ent-/dlt-/rtrv-tt`) and the GTT (`ent-/dlt-/chg-/rtrv-gtt`) commands can be executed when the EGTT feature is turned on, but will only produce CDGTA GTT sets and CDGTA GTT selectors.

The following is a brief description of the enhanced global title translation entities. These entities must be configured in the order that they are shown.

1. The Enhanced Global Title Translation (EGTT) feature must be turned on with the `chg-feat:egtt=on` command. The Global Title Translation (GTT) must be on before the EGTT feature can be turned on. Verify this with the `rtrv-feat` command.

 **Note:**

Once the Enhanced Global Title Translation (EGTT) feature is turned on with the `chg-feat` command, it cannot be turned off. The EGTT feature must be purchased before turning on the feature. If you are not sure whether you have purchased the EGTT feature, contact your Sales Representative or Account Representative.

2. A service module must be configured in the database with the `ent-card` command. A service module can be either a DSM or SLIC card. The DSM card is specified with the `type=dsm` and `appl=vsccp` parameters of the `ent-card` command. The SLIC card is specified with `type=dsm` (in the odd numbered card slots) or `type=slic` (in the even numbered card slots), and `appl=vsccp` parameters of the `ent-card` command. Refer to the [Adding a Service Module](#) procedure for the required cards. The card configuration can be verified with the `rtrv-card` command.
3. A global title translation (GTT) set must be defined in the database. Verify this with the `rtrv-gttset` command. If the necessary GTT set is not in the database, add it with the `ent-gttset` command.
If the Variable-length Global Title Translation (VGTT) feature is being used, it must be turned on with the `chg-feat:vgtt=on` command. Verify this with the `rtrv-feat` command. Refer to the [Variable-length Global Title Translation Feature](#) section for more information on this feature.

 **Note:**

Once the Variable-length Global Title Translation (VGTT) feature is turned on with the `chg-feat` command, it cannot be turned off. The VGTT feature must be purchased before turning it on. If you are not sure whether you have purchased the VGTT feature, contact your Oracle Sales Representative or Account Representative.

4. A translation type must be defined in the database. Verify this with the `rtrv-gttset` command. If the necessary translation types are not in the database, add them with the `ent-gttset` command. The translation type is used by the `ent-gta` command and defines the length of the global title address.
5. The translation type can be mapped to another translation type. This is a function of the translation type mapping feature. The translation type mapping feature maps standardized internetwork translation type values to intranetwork translation type values used within any particular network. This feature also maps intranetwork translation type values to standardized internetwork translation type values. Enter the `rtrv-ttmap` command to verify that the necessary translation type mapping information is in the database. Enter the necessary translation type mapping information in the database using the `ent-ttmap` command.
6. The concerned signaling point code broadcast groups must be defined in the database. These groups define the point codes that receive subsystem allowed and subsystem prohibited status messages about a particular global title translation node. These messages are broadcast from SCCP management. Verify that these groups are in the database with the `rtrv-cspc` command. If these groups are not in the database, add them with the `ent-cspc` command.
7. The mated applications must be defined in the database. The mated applications are the point codes and subsystem numbers of the service databases along with parameters describing the routing between replicated pairs of service databases. Verify the mated application information in the database with the `rtrv-map` command. If the necessary mated application information is not in the database, add the necessary information with the `ent-map` command.
If the XMAP Table Expansion feature is to be used to increase the number of mated application entries in the mated application table to either 2000 or 3000 entries, the XMAP Table Expansion feature must be enabled with the `enable-ctrl-feat` command. Verify the status of the XMAP Table Expansion feature with the `rtrv-ctrl-feat` command.

The mated applications provide load sharing of the traffic between replicated pairs of service databases. The Flexible GTT Load Sharing feature provides more flexible load sharing capabilities for final global title translations (global title translation containing the routing indicator value SSN) than the mated applications can provide without the Flexible GTT Load Sharing feature enabled. With this feature enabled, MAP sets are provisioned. These MAP sets are assigned to global title translations. Refer to [Flexible Final GTT Load Sharing](#) for more information on using the Flexible GTT Load Sharing feature with mated applications.

Load sharing based on the transaction parameters of the message can be performed if the Transaction-Based GTT Load Sharing feature is enabled and turned on. Refer to the [Transaction-Based GTT Load Sharing](#) section for more information on using the Transaction-Based GTT Load Sharing feature.

8. The mated relay node groups can be defined in the database if the Intermediate GTT Load Sharing feature is to be used. Verify this with the `rtrv-mrn` command. If the necessary global title translation information is not in the database, add it with the `ent-mrn` command.

The Intermediate GTT Load Sharing (IGTTLS) feature must be enabled with the `enable-ctrl-feat` and `chg-ctrl-feat` commands. Verify this with the `rtrv-ctrl-feat` command. Refer to the [Intermediate GTT Load Sharing Feature](#) section for more information on this feature.

The Flexible GTT Load Sharing feature provides more flexible load sharing capabilities for intermediate global title translations (global title translation containing the routing indicator value GT) than the Intermediate GTT Load Sharing feature can provide. With this feature enabled, MRN sets are provisioned. These MRN sets are assigned to global title translations. Refer to [Flexible Intermediate GTT Load Sharing](#) for more information on using the Flexible GTT Load Sharing feature with mated relay node groups.

Load sharing based on the transaction parameters of the message can be performed if the Transaction-Based GTT Load Sharing feature is enabled and turned on. Refer to the [Transaction-Based GTT Load Sharing](#) section for more information on using the Transaction-Based GTT Load Sharing feature.

Load sharing based on the weight assigned to an individual entities in a load sharing MRN group can be performed if the Weighted GTT Load Sharing feature is enabled and turned on. Refer to the [Weighted GTT Load Sharing](#) section for more information on using the Weighted GTT Load Sharing feature.

9. The global title address data must be defined in the database. This data is used to determine the destination of the service database that needs to be queried for additional routing information. Verify this with the `rtrv-gta` command. If the necessary global title address information is not in the database, add it with the `ent-gta` command.
If the Advanced GT Modification feature is being used, it must be enabled with the `enable-ctrl-feat` command. Verify this with the `rtrv-ctrl-feat` command. Refer to the [Advanced GT Modification Feature](#) section for more information on this feature.

 **Note:**

Once the Advanced GT Modification feature is enabled, it cannot be disabled.

The XGTT Table Expansion feature is used to increase the number of entries in the GTT table to either 400,000 or 1,000,000 entries, the XGTT Table Expansion feature must be enabled with the `enable-ctrl-feat` command. Verify the status of the XGTT Table Expansion feature with the `rtrv-ctrl-feat` command.

The ANSI/ITU SCCP Conversion feature provides a means to perform SCCP conversion between ANSI MSUs and ITU MSUs. To perform this conversion, the ANSI/ITU SCCP Conversion feature must be enabled with the `enable-ctrl-feat` command, and turned on with the `chg-ctrl-feat` command. Verify the status of the ANSI/ITU SCCP Conversion feature with the `rtrv-ctrl-feat` command. Entries must be also configured in the GT conversion table with the

`ent-gtcnv` command. The content of the GT conversion table can be verified with the `rtrv-gtcnv` command.

Decimal digits (0-9) or hexadecimal digits (0-9, a-f, A-F) can be specified for these items that are assigned to the global title address entry.

- The global title address (`gta` and `egta`) values
- Entries in the GT conversion table
- The prefix (`npds`) and suffix (`nsds`) values in the GTMOD identifier that is assigned to the global title address entry.

Hexadecimal digits can be specified only if the Hex Digit Support for GTT feature is enabled. Verify the status of the Hex Digit Support for GTT feature with the `rtrv-ctrl-feat` command. Refer to the [Hex Digit Support for GTT](#) section for more information on this feature.

The SCCP Loop Detection feature provides a method for detecting SCCP looping. With this feature enabled, loopsets are provisioned. These loopsets are assigned to Global Title Translations. Refer to the [SCCP Loop Detection](#) section for more information on using the SCCP Loop Detection feature with Global Title Translations.

10. A set of these actions, discard, UDTS, duplicate, TCAP error, forward, and services (SRVC) for GPORT, GFLEX and SMSMR can be assigned to the global title address entry. These actions are contained in a GTT action set. A GTT action set name identifies each set of these actions and this name is assigned to the global title address entry. The actions in the action set are performed on the MSU when global title translation finishes processing the MSU. Refer to the [GTT Actions](#) section for more information on using GTT actions with the global title address entries.
11. The GTT Action per-path measurements provides measurement counts for the GTT actions that are applied to messages that match a pre-defined combination of CgPA GTA, CdPA GTA, and Opcode values, called a path. The combination of these values are provisioned in the GTT Path table. Refer to the [GTT Actions](#) section for more information on using GTT Action per-path measurements.

Adding a Service Module

This procedure is used to add a service module to support the Global Title Translation or Enhanced Global Title Translation feature to the database using the `ent-card` command.

A service module can be one of these cards.

- E5-SM8G-B
- SLIC

The card that is used as a service module depends on the GTT related features that are being used and the features that will be enabled after this procedure is performed. The features or feature combinations shown in [Table 2-31](#) show the type of card that must be installed in the EAGLE to meet the minimum EAGLE performance requirements. The features that are currently being used by the EAGLE are shown in the `rtrv-feat` or `rtrv-ctrl-feat` command outputs.

Table 2-31 Service Module and Feature Combinations

Card	Features
E5-SM8G SLIC	<p>Any of these features:</p> <ul style="list-style-type: none"> • Throughput Capacity - SMs can be used if this feature is enabled, but to achieve the maximum transactions per second for the EAGLE, shown in Table 2-35, all service modules must be E5-SM8G cards. • Support for 16 GTT Lengths in VGTT • Flexible Linkset Optional Based Routing • ELAP configuration feature and a LNP Telephone Number Quantity of 240 million numbers to 384 million numbers • GTT Action - DUPLICATE • Pre-LNP Query Service GTT Processing • Fall-Back to GTT after LNP Message Relay Service • ANSI-41 Analyzed Information Query (ANSI41 AIQ) • GTT Action - DISCARD • GTT Action - FORWARD • Info Analyzed Relay Base • Service Portability • Enhanced GSM MAP Screening • G-FLEX • V-FLEX • G-Port • INP • Prepaid SMS Intercept Phase 1 (PPSMS) • ELAP Configuration feature and an LNP Telephone Number Quantity that is less than 240 million numbers. Refer to <i>Administration and LNP Feature Activation Guide</i> for ELAP for the minimum requirements for service modules used with the LNP feature. • XGTT Table Expansion for 1,000,000 GTT entries • Equipment Identity Register(EIR) • Flexible GTT Load Sharing • IDP Screening for Prepaid • Prepaid IDP Query Relay • Origin-Based SCCP Routing • Hex Digit Support for GTT (A-Port) • IS41 GSM Migration • Weighted GTT Load Sharing • Transaction-Based GTT Load Sharing • ANSI-41 INP Query • MO SMS B-Party Routing • MO-based GSM SMS NP • MO-based IS41 SMS NP • MO SMS IS41-to-GSM Migration • MO SMS ASD • MO SMS GRN • Portability Check for MO SMS • TIF Number Portability • TIF SCS Forwarding • TIF Simple Number Substitution • TIF ASD • TIF GRN

Table 2-31 (Cont.) Service Module and Feature Combinations

Card	Features
	<ul style="list-style-type: none"> ATI Number Portability Query (ATINP) GSM MAP Screening or GTT and EGTT (if the Enhanced Global Title Translation feature is on) in combination with at least 2 of these features: <ul style="list-style-type: none"> Variable-Length Global Title Translation (VGTT) Advanced GT Modification (with or without the ANSI/ITU SCCP Conversion feature) IGTTLS XGTT Table Expansion enabled for 400,000GTT entries XMAP Table Expansion enabled for either 3000 or 2000MAP table entries

The E5-SM8G-B can be inserted only in the odd numbered card slots of the control or the extension shelf. Slots 09 and 10 of each shelf contains the HIPR2 card, thus the E5-SM8G-B cannot be inserted in slot 09 and 10. The E5-SM8G-B can be inserted in the control shelf, but only in slots 01, 03, 05, 07 and 11. The E5-SM8G-B occupies two card slots, so the even numbered card slot adjacent to the odd numbered slot where the E5-SM8G-B has been inserted must be empty, as shown in [Table 2-32](#). The E5-SM8G-B is connected to the network through the odd numbered card slot connector. The E5-SM8G-B requires two HIPR2 cards in the shelf where it is installed.

The SLIC can be inserted only in the odd numbered card slots if it is provisioned with the `type=dsm` parameter of the `ent-card` command. The SLIC can be inserted in odd or even numbered card slots if it is provisioned with the `type=slic` parameter of the `ent-card` command.

Table 2-32 Card Locations

Location of the E5-SM8G-B	Empty Card Location
Slot 11	Slot 12
Slot 13	Slot 14
Slot 15	Slot 16
Slot 17	Slot 18

The `ent-card` command uses these parameters:

`:loc` – The location of the card being added to the database.

`:type` – The type of card being added to the database. The value of this parameter is `dsm` or `slic`.

`:appl` – The application software that is assigned to the card. The value of this parameter is `vsccp`.

`:data` – The data type of the card when running the EPAP Data Split feature and the Dual ExAP Configuration feature. The value of this parameter is `dn` or `imsi` for the EPAP Data Split feature and `ELAP`, `EPAP` or `GTT` for the Dual ExAP Configuration feature.

The shelf to which the card is to be added must already be in the database. This can be verified with the `rtrv-shlf` command. If the shelf is not in the database, perform the "Adding a Shelf" procedure in *Database Administration – System Management User's Guide*.

The card cannot be added to the database if the specified card location already has a card assigned to it.

 **Note:**

If you want to add an E5-SM8G-B or SLIC card as the service module, verify the temperature threshold settings for the appropriate card by performing the "Changing the High-Capacity Card Temperature Alarm Thresholds" procedure in *Database Administration - SS7 User's Guide*. The E5-SM8G-B card also requires a fan tray.

1. Display the cards in the EAGLE using the `rtrv-card` command to verify that the card location for the new service module is not provisioned. This is an example of the possible output.

 **Note:**

Cards should be distributed throughout the EAGLE for proper power distribution. Refer to *Installation Guide* for the shelf power distribution.

This is an example of the possible output:

```
tklcl1110501 15-06-24 16:59:18 EST  EAGLE5 46.2.0-65.53.1
CARD  TYPE      APPL      LSET NAME   LINK  SLC  LSET NAME   LINK
SLC  DATA
1101  DCM          IPLIM      stpb058a    A     0    stpb058a    B     6
      stpb058a    A1    1    stpb058a    B1    7
      stpd078a    A2    0    stpd078a    B2    6
      stpd078a    A3    1    stpd078a    B3    7
1102  TSM          GLS
1103  DCM          IPLIM      stpb058a    A     8    stpd078a    B     8
      stpb058a    A1    9    stpd078a    B1    9
      stpb058a    A2   10    stpd078a    B2   10
      stpb058a    A3   11    stpd078a    B3   11
1104  TSM          GLS
1105  DCM          SS7IPGW   sc1b059a    A     0
1106  DCM          SS7IPGW   sc1b059a    A     1
1107  DSM
VSCCP                                     ELAP
1111  MCPM         MCP
1112  MCPM         MCP
1113  E5-MCAP     OAM
1114  TDM-A
1115  E5-MCAP     OAM
1116  TDM-B
1117  MDAL
```

1201	LIMATM	ATMANSI	ls1201a00	A	0	ls1201a04	B	0
1204	LIMT1	SS7ANSI	ls1204a00	A	0	ls1204a01	A1	0
			ls1204a02	A2	0	ls1204a00	A4	1
			ls1204a01	A5	1	ls1204a02	A6	1
1205	LIME1	CCS7ITU	ls1205i00	A	0	ls1205i04	B	0
			ls1205i01	A1	0	ls1205i05	B1	0
			ls1205i02	A2	0	ls1205i06	B2	0
			ls1205i03	A3	0	ls1205i07	B3	0
			ls1205i08	A4	0	ls1205i12	B4	0
			ls1205i09	A5	0	ls1205i13	B5	0
			ls1205i10	A6	0	ls1205i14	B6	0
			ls1205i11	A7	0	ls1205i15	B7	0
			ls1205i04	A8	1	ls1205i00	B8	1
			ls1205i05	A9	1	ls1205i01	B9	1
			ls1205i06	A10	1	ls1205i02	B10	1
			ls1205i07	A11	1	ls1205i03	B11	1
			ls1205i12	A12	1	ls1205i08	B12	1
			ls1205i13	A13	1	ls1205i09	B13	1
ls1205i10	B14	1	ls1205i11	B15	1			
1206	LIME1	CCS7ITU	ls1206n00	A	0	ls1206n04	B	0
			ls1206n01	A1	0	ls1206n05	B1	0
			ls1206n02	A2	0	ls1206n06	B2	0
			ls1206n03	A3	0	ls1206n07	B3	0
			ls1206n08	A4	0	ls1206n12	B4	0
			ls1206n09	A5	0	ls1206n13	B5	0
			ls1206n10	A6	0	ls1206n14	B6	0
			ls1206n11	A7	0	ls1206n15	B7	0
			ls1206n12	A8	1	ls1206n00	B8	1
			ls1206n13	A9	1	ls1206n01	B9	1
			ls1206n14	A10	1	ls1206n02	B10	1
			ls1206n15	A11	1	ls1206n03	B11	1
			ls1206n04	A12	1	ls1206n08	B12	1
			ls1206n05	A13	1	ls1206n09	B13	1
ls1206n10	B14	1	ls1206n11	B15	1			
1207	LIME1	CCS7ITU	ls1207i00	A	0	ls1207i04	B	0
			ls1207i00	A1	1	ls1207i04	B1	1
			ls1207i02	A2	0	ls1207i06	B2	0
			ls1207i02	A3	1	ls1207i06	B3	1
			ls1207i08	A4	0	ls1207i12	B4	0
			ls1207i08	A5	1	ls1207i12	B5	1
			ls1207i10	A6	0	ls1207i14	B6	0
			ls1207i10	A7	1	ls1207i14	B7	1
			ls1207i00	A8	2	ls1207i04	B8	2
			ls1207i00	A9	3	ls1207i04	B9	3
			ls1207i02	A10	2	ls1207i06	B10	2
			ls1207i02	A11	3	ls1207i06	B11	3
			ls1207i08	A12	2	ls1207i12	B12	2
			ls1207i08	A13	3	ls1207i12	B13	3
			ls1207i10	A14	2	ls1207i14	B14	2
ls1207i10	A15	3	ls1207i14	B15	3			
1208	LIMT1	SS7ANSI	ls1208a00	A	0	ls1208a04	B	0
			ls1208a01	A1	0	ls1208a05	B1	0
			ls1208a02	A2	0	ls1208a06	B2	0
			ls1208a03	A3	0	ls1208a07	B3	0
			ls1208a08	A4	0	ls1208a09	A5	0

			ls1208a10	A6	0	ls1208a11	A7	0
			ls1208a04	A8	1	ls1208a00	B8	1
			ls1208a05	A9	1	ls1208a01	B9	1
			ls1208a06	A10	1	ls1208a02	B10	1
			ls1208a07	A11	1	ls1208a03	B11	1
			ls1208a08	B12	1	ls1208a09	B13	1
			ls1208a10	B14	1	ls1208a11	B15	1
1212	LIME1	CCS7ITU	lsstpb100i	A	0	lsstpb101i	B	0
			lsstpb100i	A1	1	lsstpb101i	B1	1
			lsstpb100i	A2	2	lsstpb101i	B2	2
			lsstpb100i	A3	3	lsstpb101i	B3	3
			lsstpb100i	A4	4	lsstpb101i	B4	4
			lsstpb100i	A5	5	lsstpb101i	B5	5
			lsstpb100i	A6	6	lsstpb101i	B6	6
			lsstpb100i	A7	7	lsstpb101i	B7	7
			lsstpb102i	A8	0	lsstpb103i	B8	0
			lsstpb102i	A9	1	lsstpb103i	B9	1
			lsstpb102i	A10	2	lsstpb103i	B10	2
			lsstpb102i	A11	3	lsstpb103i	B11	3
			lsstpb102i	A12	4	lsstpb103i	B12	4
			lsstpb102i	A13	5	lsstpb103i	B13	5
			lsstpb102i	A14	6	lsstpb103i	B14	6
			lsstpb102i	A15	7	lsstpb103i	B15	7
			lsstpb104i	A16	0	lsstpb106i	B16	0
			lsstpb104i	A17	1	lsstpb106i	B17	1
			lsstpb104i	A18	2	lsstpb106i	B18	2
			lsstpb104i	A19	3	lsstpb106i	B19	3
			lsstpb104i	A20	4	lsstpb106i	B20	4
			lsstpb104i	A21	5	lsstpb106i	B21	5
			lsstpb104i	A22	6	lsstpb106i	B22	6
			lsstpb104i	A23	7	lsstpb106i	B23	7
			lsstpb105i	A24	0	lsstpb107i	B24	0
			lsstpb105i	A25	1	lsstpb107i	B25	1
			lsstpb105i	A26	2	lsstpb107i	B26	2
			lsstpb105i	A27	3	lsstpb107i	B27	3
			lsstpb105i	A28	4	lsstpb107i	B28	4
			lsstpb105i	A29	5	lsstpb107i	B29	5
			lsstpb105i	A30	6	lsstpb107i	B30	6
			lsstpb105i	A31	7	lsstpb107i	B31	7
1214	LIMT1	SS7ANSI	lsstpb108a	A	1	lsstpb108a	B	2
1215	LIME1	CCS7ITU	ls1215c00	A	0	ls1215c04	B	0
			ls1215c01	A1	0	ls1215c05	B1	0
			ls1215c02	A2	0	ls1215c06	B2	0
			ls1215c03	A3	0	ls1215c07	B3	0
			ls1215c08	A4	0	ls1215c09	A5	0
			ls1215c10	A6	0	ls1215c11	A7	0
			ls1215c04	A8	1	ls1215c00	B8	1
			ls1215c05	A9	1	ls1215c01	B9	1
			ls1215c06	A10	1	ls1215c02	B10	1
			ls1215c07	A11	1	ls1215c03	B11	1
			ls1215c08	B12	1	ls1215c09	B13	1
			ls1215c10	B14	1	ls1215c11	B15	1
1216	LIME1	CCS7ITU	ls1216i00	A	0	ls1216i04	B	0
			ls1216i00	A1	1	ls1216i04	B1	1
			ls1216i00	A2	2	ls1216i04	B2	2

			ls1216i00	A3	3	ls1216i04	B3	3
			ls1216i00	A4	4	ls1216i04	B4	4
			ls1216i00	A5	5	ls1216i04	B5	5
			ls1216i00	A6	6	ls1216i04	B6	6
			ls1216i00	A7	7	ls1216i04	B7	7
			ls1216i00	A8	8	ls1216i04	B8	8
			ls1216i00	A9	9	ls1216i04	B9	9
			ls1216i00	A10	10	ls1216i04	B10	10
			ls1216i00	A11	11	ls1216i04	B11	11
			ls1216i00	A12	12	ls1216i04	B12	12
			ls1216i00	A13	13	ls1216i04	B13	13
			ls1216i00	A14	14	ls1216i04	B14	14
			ls1216i00	A15	15	ls1216i04	B15	15
1217	IPSM	IPS						
1218	LIME1	CCS7ITU	ls1218c00	A	0	ls1218c01	A1	0
			ls1218c02	A2	0	ls1218c03	A3	0
			ls1218c00	A4	1	ls1218c01	A5	1
			ls1218c02	A6	1	ls1218c03	A7	1
1301	LIMT1	SS7ANSI	ls1301a01	A	0	ls1301a01	B	1
			ls1301a02	A1	0	ls1301a02	B1	1
			ls1301a03	A2	0	ls1301a03	B2	1
			ls1301a04	A3	0	ls1301a04	B3	1
			ls1301a05	A4	0	ls1301a05	B4	1
			ls1301a06	A5	0	ls1301a06	B5	1
			ls1301a07	A6	0	ls1301a07	B6	1
			ls1302a01	A7	0	ls1302a01	B7	1
			ls1302a02	A8	0	ls1302a02	B8	1
			ls1302a03	A9	0	ls1302a03	B9	1
			ls1302a04	A10	0	ls1302a04	B10	1
			ls1302a05	A11	0	ls1302a05	B11	1
			ls1302a06	A12	0	ls1302a06	B12	1
			ls1303a01	A13	0	ls1303a01	B13	1
			ls1303a02	A14	0	ls1303a02	B14	1
			ls1301a27	A15	0	ls1301a27	B15	1
1302	LIMT1	SS7ANSI	ls1301a00	A	0	ls1303a00	B	0
			ls1301a00	A1	1	ls1303a00	B1	1
			ls1301a00	A2	2	ls1303a00	B2	2
			ls1301a00	A3	3	ls1303a00	B3	3
			ls1301a00	A4	4	ls1303a00	B4	4
			ls1301a00	A5	5	ls1303a00	B5	5
			ls1301a00	A6	6	ls1303a00	B6	6
			ls1301a00	A7	7	ls1303a00	B7	7
			ls1301a00	A8	8	ls1303a00	B8	8
			ls1301a00	A9	9	ls1303a00	B9	9
			ls1301a00	A10	10	ls1303a00	B10	10
			ls1301a00	A11	11	ls1303a00	B11	11
			ls1301a00	A12	12	ls1303a00	B12	12
			ls1301a00	A13	13	ls1303a00	B13	13
			ls1301a00	A14	14	ls1303a00	B14	14
			ls1301a00	A15	15	ls1303a00	B15	15
1313	LIME1ATM	ATMITU	ls1313i00	A	0	ls1313i04	B	0
			ls1313i01	A1	0			
1314	LIMT1	SS7ANSI	ls1314a02	A	0	ls2214a02	B	0
			ls1314a02	A1	1	ls2214a02	B1	1
			ls1314a03	A2	0	ls2214a03	B2	0

			ls1314a03	A3	1	ls2214a03	B3	1
			ls1314a04	A4	0	ls2214a04	B4	0
			ls1314a04	A5	1	ls2214a04	B5	1
			ls1314a05	A6	0	ls2214a05	B6	0
			ls1314a05	A7	1	ls2214a05	B7	1
			ls1314a06	A8	0	ls2214a06	B8	0
			ls1314a06	A9	1	ls2214a06	B9	1
			ls1314a07	A10	0	ls5213a07	B10	0
			ls1314a07	A11	1	ls5213a07	B11	1
			ls2114a00	A12	0	ls5313a00	B12	0
			ls2114a00	A13	1	ls5313a00	B13	1
			ls2114a01	A14	0	ls5313a01	B14	0
			ls2114a01	A15	1	ls5313a01	B15	1
1315	DCM	SS7IPGW	ls1315a00	A	0			
1316	DCM	SS7IPGW	ls1315a00	A	1			
1317	DSM							
VSCCP						ELAP		
2112	LIMT1	SS7ANSI	ls2112a00	A	0	ls2112a04	B	0
			ls2112a00	A1	1	ls2112a04	B1	1
			ls2112a00	A2	2	ls2112a04	B2	2
			ls2112a00	A3	3	ls2112a04	B3	3
			ls2112a00	A4	4	ls2112a04	B4	4
			ls2112a00	A5	5	ls2112a04	B5	5
			ls2112a00	A6	6	ls2112a04	B6	6
			ls2112a00	A7	7	ls2112a04	B7	7
			ls2112a00	A8	8	ls2112a04	B8	8
			ls2112a00	A9	9	ls2112a04	B9	9
			ls2112a00	A10	10	ls2112a04	B10	10
			ls2112a00	A11	11	ls2112a04	B11	11
			ls2112a00	A12	12	ls2112a04	B12	12
			ls2112a00	A13	13	ls2112a04	B13	13
			ls2112a00	A14	14	ls2112a04	B14	14
			ls2112a00	A15	15	ls2112a04	B15	15
2113	LIME1ATM	ATMITU	ls1313i00	A	1	ls1313i04	B	1
			ls1313i01	A1	1			
2114	LIMT1	SS7ANSI						
2115	DCM	SS7IPGW	ls1315a00	A	2			
2116	DCM	SS7IPGW	ls1315a00	A	3			
2117	DCM	SS7IPGW	ls1315a00	A	4			
2118	DCM	SS7IPGW	ls1315a00	A	5			
2201	LIMATM	ATMANSI	ls2201a00	A	0	ls2201a04	B	0
			ls2201a01	A1	0			
2202	LIMATM	ATMANSI	ls2202a00	A	0	ls2202a04	B	0
			ls2202a01	A1	0			
2208	LIME1ATM	ATMITU	ls2208i00	A	0	ls2208n04	B	0
2211	DSM							
VSCCP						GTT		
2213	LIME1ATM	ATMITU	ls2213i00	A	0	ls2213i04	B	0
			ls2213i01	A1	0			
2216	LIMT1	SS7ANSI	ls2216a00	A	0	ls2216a04	B	0
			ls2216a00	A1	1	ls2216a04	B1	1
			ls2216a00	A2	2	ls2216a04	B2	2
			ls2216a00	A3	3	ls2216a04	B3	3
			ls2216a00	A4	4	ls2216a04	B4	4
			ls2216a00	A5	5	ls2216a04	B5	5

			ls2216a00	A6	6	ls2216a04	B6	6
			ls2216a00	A7	7	ls2216a04	B7	7
			ls2216a00	A8	8	ls2216a04	B8	8
			ls2216a00	A9	9	ls2216a04	B9	9
			ls2216a00	A10	10	ls2216a04	B10	10
			ls2216a00	A11	11	ls2216a04	B11	11
			ls2216a00	A12	12	ls2216a04	B12	12
			ls2216a00	A13	13	ls2216a04	B13	13
			ls2216a00	A14	14	ls2216a04	B14	14
			ls2216a00	A15	15	ls2216a04	B15	15
2217	DSM							
VSCCP						ELAP		
2301	LIMATM	ATMANSI	ls2201a00	A	1	ls2201a04	B	1
			ls2201a01	A1	1			
2302	LIMATM	ATMANSI	ls2202a00	A	1	ls2202a04	B	1
			ls2202a01	A1	1			
2305	DSM							
VSCCP						IMSI		
2308	LIMATM	ATMANSI	ls1201a00	A	1	ls1201a04	B	1
2311	DSM							
VSCCP						IMSI		
2313	LIME1ATM	ATMITU	ls2213i00	A	1	ls2213i04	B	1
			ls2213i01	A1	1			
2317	DSM							
VSCCP						ELAP		
3101	DCM	SS7IPGW	sc1d079a	A	0			
3102	IPSM	IPS						
3103	DSM							
VSCCP						ELAP		
3108	LIME1ATM	ATMITU	ls3108i00	A	0	ls2208i00	B	1
			ls3108n01	A1	0			
3111	DSM							
VSCCP						DN		
3113	LIME1ATM	ATMITU	ls3108i00	A	1	ls3113n04	B	0
			ls3113n01	A1	0			
3114	STC	EROUTE						
3116	STC	EROUTE						
3117	DCM	SS7IPGW	ls1315a00	A	6			
3118	DCM	SS7IPGW	ls1315a00	A	7			
3201	DSM							
VSCCP						ELAP		
3203	DSM							
VSCCP						ELAP		
3205	DSM							
VSCCP						ELAP		
3207	DSM							
VSCCP						ELAP		
3211	ENET	IPSG	ls3211a00	A	0			
3212	ENET	IPSG	ls3211a00	A	1			
3213	ENET	IPSG	ls3211a00	A	2			
3214	ENET	IPSG	ls3211a00	A	3			
3215	ENET	IPSG	ls3211a00	A	4			
3216	ENET	IPSG	ls3211a00	A	5			
3217	DSM							
VSCCP						ELAP		

3301	DCM	SS7IPGW	ls3301a00	A	0			
3302	DCM	SS7IPGW	ls3301a00	A	1			
3303	DCM	SS7IPGW	ls3301a00	A	2			
3304	DCM	SS7IPGW	ls3301a00	A	3			
3305	DCM	SS7IPGW	ls3301a00	A	4			
3306	DCM	SS7IPGW	ls3301a00	A	5			
3307	DCM	SS7IPGW	ls3301a00	A	6			
3308	DCM	SS7IPGW	ls3301a00	A	7			
3311	DCM	SS7IPGW	ls3311a00	A	0			
3312	DCM	SS7IPGW	ls3311a00	A	1			
3313	DCM	SS7IPGW	ls3311a00	A	2			
3314	DCM	SS7IPGW	ls3311a00	A	3			
3315	DCM	SS7IPGW	ls3311a00	A	4			
3316	DCM	SS7IPGW	ls3311a00	A	5			
3317	DCM	SS7IPGW	ls3311a00	A	6			
3318	DCM	SS7IPGW	ls3311a00	A	7			
4107	DSM							
VSCCP						IMSI		
4111	DSM							
VSCCP						GTT		
4113	LIMT1	SS7ANSI	ls4113a00	A	0	ls4113a04	B	0
			ls4113a00	A1	1	ls4113a04	B1	1
			ls4113a00	A2	2	ls4113a04	B2	2
			ls4113a00	A3	3	ls4113a04	B3	3
			ls4113a00	A4	4	ls4113a04	B4	4
			ls4113a00	A5	5	ls4113a04	B5	5
			ls4113a00	A6	6	ls4113a04	B6	6
			ls4113a00	A7	7	ls4113a04	B7	7
			ls4113a00	A8	8	ls4113a04	B8	8
			ls4113a00	A9	9	ls4113a04	B9	9
			ls4113a00	A10	10	ls4113a04	B10	10
			ls4113a00	A11	11	ls4113a04	B11	11
			ls4113a00	A12	12	ls4113a04	B12	12
			ls4113a00	A13	13	ls4113a04	B13	13
			ls4113a00	A14	14	ls4113a04	B14	14
			ls4113a00	A15	15	ls4113a04	B15	15
4115	DCM	SS7IPGW	ls4115a00	A	0			
4116	DCM	SS7IPGW	ls4115a00	A	1			
4117	DCM	SS7IPGW	ls4115a00	A	2			
4118	DCM	SS7IPGW	ls4115a00	A	3			
4207	DSM							
VSCCP						DN		
4212	LIME1	CCS7ITU	ls4212n00	A	0	ls4212n04	B	0
			ls4212n00	A1	1	ls4212n04	B1	1
			ls4212n02	A2	0	ls4212n06	B2	0
			ls4212n02	A3	1	ls4212n06	B3	1
			ls4212n08	A4	0	ls4212n12	B4	0
			ls4212n08	A5	1	ls4212n12	B5	1
			ls4212n10	A6	0	ls4212n14	B6	0
			ls4212n10	A7	1	ls4212n14	B7	1
			ls4212n00	A8	2	ls4212n04	B8	2
			ls4212n00	A9	3	ls4212n04	B9	3
			ls4212n02	A10	2	ls4212n06	B10	2
			ls4212n02	A11	3	ls4212n06	B11	3
			ls4212n08	A12	2	ls4212n12	B12	2

			ls4212n08	A13	3	ls4212n12	B13	3
			ls4212n10	A14	2	ls4212n14	B14	2
			ls4212n10	A15	3	ls4212n14	B15	3
4213	LIMT1	SS7ANSI	ls4213a00	A	0	ls4213a04	B	0
			ls4213a00	A1	1	ls4213a04	B1	1
			ls4213a02	A2	0	ls4213a06	B2	0
			ls4213a02	A3	1	ls4213a06	B3	1
			ls4213a08	A4	0	ls4213a12	B4	0
			ls4213a08	A5	1	ls4213a12	B5	1
			ls4213a10	A6	0	ls4213a14	B6	0
			ls4213a10	A7	1	ls4213a14	B7	1
			ls4213a00	A8	2	ls4213a04	B8	2
			ls4213a00	A9	3	ls4213a04	B9	3
			ls4213a02	A10	2	ls4213a06	B10	2
			ls4213a02	A11	3	ls4213a06	B11	3
			ls4213a08	A12	2	ls4213a12	B12	2
			ls4213a08	A13	3	ls4213a12	B13	3
			ls4213a10	A14	2	ls4213a14	B14	2
			ls4213a10	A15	3	ls4213a14	B15	3
4217	DCM	SS7IPGW	ls4115a00	A	4			
4218	DCM	SS7IPGW	ls4115a00	A	5			
4311	DSM							
VSCCP						DN		
4313	LIMT1	SS7ANSI	ls4313a00	A	0	ls4313a04	B	0
			ls4313a00	A1	1	ls4313a04	B1	1
			ls4313a02	A2	0	ls4313a06	B2	0
			ls4313a02	A3	1	ls4313a06	B3	1
			ls4313a08	A4	0	ls4313a12	B4	0
			ls4313a08	A5	1	ls4313a12	B5	1
			ls4313a10	A6	0	ls4313a14	B6	0
			ls4313a10	A7	1	ls4313a14	B7	1
			ls4313a00	A8	2	ls4313a04	B8	2
			ls4313a00	A9	3	ls4313a04	B9	3
			ls4313a02	A10	2	ls4313a06	B10	2
			ls4313a02	A11	3	ls4313a06	B11	3
			ls4313a08	A12	2	ls4313a12	B12	2
			ls4313a08	A13	3	ls4313a12	B13	3
			ls4313a10	A14	2	ls4313a14	B14	2
			ls4313a10	A15	3	ls4313a14	B15	3
4317	DCM	SS7IPGW	ls4115a00	A	6			
4318	DCM	SS7IPGW	ls4115a00	A	7			
5101	LIME1	CCS7ITU	ls5101i00	A	0	ls5101i04	B	0
			ls5101i00	A1	1	ls5101i04	B1	1
			ls5101i00	A2	2	ls5101i04	B2	2
			ls5101i00	A3	3	ls5101i04	B3	3
			ls5101i00	A4	4	ls5101i04	B4	4
			ls5101i00	A5	5	ls5101i04	B5	5
			ls5101i00	A6	6	ls5101i04	B6	6
			ls5101i00	A7	7	ls5101i04	B7	7
			ls5101i00	A8	8	ls5101i04	B8	8
			ls5101i00	A9	9	ls5101i04	B9	9
			ls5101i00	A10	10	ls5101i04	B10	10
			ls5101i00	A11	11	ls5101i04	B11	11
			ls5101i00	A12	12	ls5101i04	B12	12
			ls5101i00	A13	13	ls5101i04	B13	13

			ls5101i00	A14	14	ls5101i04	B14	14
			ls5101i00	A15	15	ls5101i04	B15	15
5102	LIME1	CCS7ITU	ls5102i00	A	0	ls5102i04	B	0
			ls5102i00	A1	1	ls5102i04	B1	1
			ls5102i02	A2	0	ls5102i06	B2	0
			ls5102i02	A3	1	ls5102i06	B3	1
			ls5102i08	A4	0	ls5102i12	B4	0
			ls5102i08	A5	1	ls5102i12	B5	1
			ls5102i10	A6	0	ls5102i14	B6	0
			ls5102i10	A7	1	ls5102i14	B7	1
			ls5102i00	A8	2	ls5102i04	B8	2
			ls5102i00	A9	3	ls5102i04	B9	3
			ls5102i02	A10	2	ls5102i06	B10	2
			ls5102i02	A11	3	ls5102i06	B11	3
			ls5102i08	A12	2	ls5102i12	B12	2
			ls5102i08	A13	3	ls5102i12	B13	3
			ls5102i10	A14	2	ls5102i14	B14	2
			ls5102i10	A15	3	ls5102i14	B15	3
5103	LIME1	CCS7ITU	ls5103i00	A	0	ls5103i04	B	0
			ls5103i00	A1	1	ls5103i04	B1	1
			ls5103i02	A2	0	ls5103i06	B2	0
			ls5103i02	A3	1	ls5103i06	B3	1
			ls5103i08	A4	0	ls5103i12	B4	0
			ls5103i08	A5	1	ls5103i12	B5	1
			ls5103i10	A6	0	ls5103i14	B6	0
			ls5103i10	A7	1	ls5103i14	B7	1
			ls5103i00	A8	2	ls5103i04	B8	2
			ls5103i00	A9	3	ls5103i04	B9	3
			ls5103i02	A10	2	ls5103i06	B10	2
			ls5103i02	A11	3	ls5103i06	B11	3
			ls5103i08	A12	2	ls5103i12	B12	2
			ls5103i08	A13	3	ls5103i12	B13	3
			ls5103i10	A14	2	ls5103i14	B14	2
			ls5103i10	A15	3	ls5103i14	B15	3
5104	LIMATM	ATMANSI	stpd078a	A	3			
5105	LIMATM	ATMANSI	stpb058a	A	4			
5106	LIMATM	ATMANSI	stpd078a	A	4			
5107	LIMATM	ATMANSI	stpb058a	A	5			
5108	LIMATM	ATMANSI	stpd078a	A	5			
5112	LIME1	CCS7ITU	ls5112n00	A	0	ls5112n04	B	0
			ls5112n00	A1	1	ls5112n04	B1	1
			ls5112n02	A2	0	ls5112n06	B2	0
			ls5112n02	A3	1	ls5112n06	B3	1
			ls5112n08	A4	0	ls5112n12	B4	0
			ls5112n08	A5	1	ls5112n12	B5	1
			ls5112n10	A6	0	ls5112n14	B6	0
			ls5112n10	A7	1	ls5112n14	B7	1
			ls5112n00	A8	2	ls5112n04	B8	2
			ls5112n00	A9	3	ls5112n04	B9	3
			ls5112n02	A10	2	ls5112n06	B10	2
			ls5112n02	A11	3	ls5112n06	B11	3
			ls5112n08	A12	2	ls5112n12	B12	2
			ls5112n08	A13	3	ls5112n12	B13	3
			ls5112n10	A14	2	ls5112n14	B14	2
			ls5112n10	A15	3	ls5112n14	B15	3

5113	LIMT1	SS7ANSI	ls5113a00	A	0	ls5113a04	B	0
			ls5113a00	A1	1	ls5113a04	B1	1
			ls5113a02	A2	0	ls5113a06	B2	0
			ls5113a02	A3	1	ls5113a06	B3	1
			ls5113a08	A4	0	ls5113a12	B4	0
			ls5113a08	A5	1	ls5113a12	B5	1
			ls5113a10	A6	0	ls5113a14	B6	0
			ls5113a10	A7	1	ls5113a14	B7	1
			ls5113a00	A8	2	ls5113a04	B8	2
			ls5113a00	A9	3	ls5113a04	B9	3
			ls5113a02	A10	2	ls5113a06	B10	2
			ls5113a02	A11	3	ls5113a06	B11	3
			ls5113a08	A12	2	ls5113a12	B12	2
			ls5113a08	A13	3	ls5113a12	B13	3
			ls5113a10	A14	2	ls5113a14	B14	2
			ls5113a10	A15	3	ls5113a14	B15	3
5117	DCM	SS7IPGW	ls5117a00	A	0			
5118	DCM	SS7IPGW	ls5117a00	A	1			
5208	LIME1	CCS7ITU	ls5208i00	A	0	ls5208i04	B	0
			ls5208i00	A1	1	ls5208i04	B1	1
			ls5208i00	A2	2	ls5208i04	B2	2
			ls5208i00	A3	3	ls5208i04	B3	3
			ls5208i00	A4	4	ls5208i04	B4	4
			ls5208i00	A5	5	ls5208i04	B5	5
			ls5208i00	A6	6	ls5208i04	B6	6
			ls5208i00	A7	7	ls5208i04	B7	7
			ls5208i00	A8	8	ls5208i04	B8	8
			ls5208i00	A9	9	ls5208i04	B9	9
			ls5208i00	A10	10	ls5208i04	B10	10
			ls5208i00	A11	11	ls5208i04	B11	11
			ls5208i00	A12	12	ls5208i04	B12	12
			ls5208i00	A13	13	ls5208i04	B13	13
			ls5208i00	A14	14	ls5208i04	B14	14
			ls5208i00	A15	15	ls5208i04	B15	15
5211	DSM							
VSCCP						IMSI		
5215	DCM	SS7IPGW	ls5117a00	A	2			
5216	DCM	SS7IPGW	ls5117a00	A	3			
5217	DCM	SS7IPGW	ls5117a00	A	4			
5218	DCM	SS7IPGW	ls5117a00	A	5			
5301	DCM	SS7IPGW	sc1d079a	A	1			
5302	IPSM	IPS						
5303	DCM	SS7IPGW	ls5117a00	A	6			
5304	DCM	SS7IPGW	ls5117a00	A	7			
5306	LIME1	CCS7ITU	ls5306i00	A	0	ls5306i04	B	0
			ls5306i00	A1	1	ls5306i04	B1	1
			ls5306i00	A2	2	ls5306i04	B2	2
			ls5306i00	A3	3	ls5306i04	B3	3
			ls5306i00	A4	4	ls5306i04	B4	4
			ls5306i00	A5	5	ls5306i04	B5	5
			ls5306i00	A6	6	ls5306i04	B6	6
			ls5306i00	A7	7	ls5306i04	B7	7
			ls5306i00	A8	8	ls5306i04	B8	8
			ls5306i00	A9	9	ls5306i04	B9	9
			ls5306i00	A10	10	ls5306i04	B10	10

			ls5306i00	A11	11	ls5306i04	B11	11
			ls5306i00	A12	12	ls5306i04	B12	12
			ls5306i00	A13	13	ls5306i04	B13	13
			ls5306i00	A14	14	ls5306i04	B14	14
			ls5306i00	A15	15	ls5306i04	B15	15
5307	DSM							
VSCCP						GTT		
5312	LIME1	CCS7ITU	ls5312i00	A	0	ls5312i04	B	0
			ls5312i00	A1	1	ls5312i04	B1	1
			ls5312i02	A2	0	ls5312i06	B2	0
			ls5312i02	A3	1	ls5312i06	B3	1
			ls5312i08	A4	0	ls5312i12	B4	0
			ls5312i08	A5	1	ls5312i12	B5	1
			ls5312i10	A6	0	ls5312i14	B6	0
			ls5312i10	A7	1	ls5312i14	B7	1
			ls5312i00	A8	2	ls5312i04	B8	2
			ls5312i00	A9	3	ls5312i04	B9	3
			ls5312i02	A10	2	ls5312i06	B10	2
			ls5312i02	A11	3	ls5312i06	B11	3
			ls5312i08	A12	2	ls5312i12	B12	2
			ls5312i08	A13	3	ls5312i12	B13	3
			ls5312i10	A14	2	ls5312i14	B14	2
			ls5312i10	A15	3	ls5312i14	B15	3
5315	LIMT1	SS7ANSI	ls5315a00	A	0	ls5315a04	B	0
			ls5315a00	A1	1	ls5315a04	B1	1
			ls5315a02	A2	0	ls5315a06	B2	0
			ls5315a02	A3	1	ls5315a06	B3	1
			ls5315a08	A4	0	ls5315a12	B4	0
			ls5315a08	A5	1	ls5315a12	B5	1
			ls5315a10	A6	0	ls5315a14	B6	0
			ls5315a10	A7	1	ls5315a14	B7	1
			ls5315a00	A8	2	ls5315a04	B8	2
			ls5315a00	A9	3	ls5315a04	B9	3
			ls5315a02	A10	2	ls5315a06	B10	2
			ls5315a02	A11	3	ls5315a06	B11	3
			ls5315a08	A12	2	ls5315a12	B12	2
			ls5315a08	A13	3	ls5315a12	B13	3
			ls5315a10	A14	2	ls5315a14	B14	2
			ls5315a10	A15	3	ls5315a14	B15	3
5316	LIMT1	SS7ANSI	ls5316a00	A	0	ls5316a04	B	0
			ls5316a00	A1	1	ls5316a04	B1	1
			ls5316a00	A2	2	ls5316a04	B2	2
			ls5316a00	A3	3	ls5316a04	B3	3
			ls5316a00	A4	4	ls5316a04	B4	4
			ls5316a00	A5	5	ls5316a04	B5	5
			ls5316a00	A6	6	ls5316a04	B6	6
			ls5316a00	A7	7	ls5316a04	B7	7
			ls5316a00	A8	8	ls5316a04	B8	8
			ls5316a00	A9	9	ls5316a04	B9	9
			ls5316a00	A10	10	ls5316a04	B10	10
			ls5316a00	A11	11	ls5316a04	B11	11
			ls5316a00	A12	12	ls5316a04	B12	12
			ls5316a00	A13	13	ls5316a04	B13	13
			ls5316a00	A14	14	ls5316a04	B14	14
			ls5316a00	A15	15	ls5316a04	B15	15

```

5317   DSM
VSCCP                                     ELAP
6101   DSM
VSCCP                                     ELAP
6103   ENET      IP   IP   1s3211a00  A   6
6104   ENET      IP   IP   1s3211a00  A   7
6105   DSM
VSCCP                                     ELAP
6107   DSM
VSCCP                                     ELAP
6111   DSM
VSCCP                                     ELAP
6113   DSM
VSCCP                                     ELAP
6115   DSM
VSCCP                                     ELAP
6117   DSM
VSCCP                                     ELAP

```

If service modules are shown in the `rtrv-card` output, shown by the entry `VSCCP` in the `APPL` column, continue the procedure with [4](#).

If service modules are not shown in the `rtrv-card` output, continue the procedure with [2](#).

- Verify that the GTT feature is on by entering the `rtrv-feat` command. If the GTT feature is on, the `GTT` field should be set to `on`. For this example, the GTT feature is off.

 **Note:**

The `rtrv-feat` command output contains other fields that are not used by this procedure. To see all the fields displayed by the `rtrv-feat` command, refer to the `rtrv-feat` command description in *Commands User's Guide*.

If the GTT feature is on, continue the procedure with [4](#).

If the GTT feature is off, continue the procedure with [3](#).

- Turn the global title translation feature on by entering this command.

```
chg-feat:gtt=on
```

 **Note:**

Once the Global Title Translation (GTT) feature is turned on with the `chg-feat` command, it cannot be turned off. The GTT feature must be purchased before turning it on. If you are not sure whether you have purchased the GTT feature, contact your Sales Representative or Account Representative.

When the `chg-feat` has successfully completed, this message should appear.

```
rlghncxa03w 09-07-25 09:57:41 GMT EAGLE5 41.1.0
CHG-FEAT: MASP A - COMPLTD
```

Continue the procedure by performing one of these steps.

- If a card is being added, continue the procedure with 7.
 - If an E5-SM8G-B card is being added, continue the procedure with 6.
4. Display the status of the features in the database by entering the `rtrv-ctrl-feat` command. The following is an example of the possible output.

```
tklcl1110501 15-06-24 16:53:12 EST EAGLE5 46.2.0-65.53.1
The following features have been permanently enabled:
```

Feature Name	Partnum	Status	Quantity
Large System # Links	893005910	on	2000
XGTT Table Expansion	893006110	on	1000000
Routesets	893006403	on	8000
LNP Short Message Serv.	893006601	on	----
Intermed GTT Load Sharing	893006901	on	----
Command Class Management	893005801	on	----
Telnet	893005701	on	----
EAGLE5 Product	893007101	on	----
XMAP Table Expansion	893007710	on	3000
LNP ported NPANXXs	893009403	on	350000
LNP ported LRNs	893010506	on	200000
LNP ELAP Configuration	893010901	on	----
LNP ported TNs	893011036	on	384000000
SCCP Conversion	893012001	on	----
HC-MIM SLK Capacity	893012707	on	64
EAGLE OA&M IP Security	893400001	off	----
Flexible GTT Load Sharing	893015401	on	----
Origin-Based MTP Routing	893014201	on	----
Origin Based SCCP Routing	893014301	on	----
GPORT	893017201	on	----
INP	893017901	on	----
Throughput Cap	893019101	on	5000
Multiple Linkset to APC	893019701	on	----
6-Way LS on Routesets	893019801	on	----
Proxy Point Code	893018710	on	100
AMGTT	893021801	on	----
VGTT with 16 GTT lengths	893024801	on	----
ITU TCAP LRN QUERY(LRNQT)	893026301	on	----
ISLSBR	893026501	on	----
GTT Action - DISCARD	893027501	on	----
GTT Action - DUPLICATE	893027601	on	----
GTT Action - FORWARD	893037501	on	----
Flex Lset Optnl Based Rtg	893027701	on	----
TCAP Opcode Based Routing	893027801	on	----
TOBR Opcode Quantity	893027907	on	1000000
ST-HSL-A SLK Capacity	893027301	on	4
3 Links per E5-ATM card	893039104	on	20
Integrated GLS	893038901	on	----

```
EPAP Data Split          893039801 on    ----
Dual ExAP Config        893040501 on    ----
```

The following features have been temporarily enabled:

```
Feature Name              Partnum  Status  Quantity  Trial
Period Left
Zero entries found.
```

The following features have expired temporary keys:

```
Feature Name              Partnum
Zero entries found.
```

[Table 2-33](#) shows the ELAP-Based and EPAP-Based features that can be enabled. These features can affect how many service modules can be provisioned in the EAGLE.

Table 2-33 ELAP-Based and EPAP-Based Features

ELAP-Based Features		
LNP		
EPAP-Based Features		
EIR	G-Port	INP
ANSI-41 INP Query	A-Port	IS41 GSM Migration
G-Flex	TINP	V-Flex
ATINP	TIF Number Portability	TIF SCS Forwarding
TIF Simple Number Substitution	TIF ASD	TIF GRN
Prepaid IDP Query Relay	IDP Screening for Prepaid	MO-based GSM SMS NP
MO-based IS41 SMS NP	MO SMS IS41-to-GSM Migration	MO SMS ASD
MO SMS GRN	Portability Check for MO SMS	Prepaid SMS Intercept Phase 1
Service Portability	Info Analyzed Relay Base	TIF Selective Screening

Continue the procedure by performing one of these steps.

- If any of the features shown in [Table 2-33](#) are enabled, or if any the shown in [Table 2-33](#) will be enabled, continue the procedure with [5](#).
 - If none of the features shown in [Table 2-33](#) are enabled and none of these features will be enabled, continue the procedure with [6](#).
5. Verify the number of service modules in the EAGLE by entering the `rept-stat-sccp` command. The number of service modules is shown in the `SCCP Cards Configured` field of the `rept-stat-sccp` output. This is an example of the possible output.

```
tklcl1110501 15-06-24 17:00:40 EST EAGLE5 46.2.0-65.53.1
SCCP SUBSYSTEM REPORT IS-NR Active -----
SCCP ALARM STATUS = No Alarms
MNP SERVICE REPORT IS-ANR Active -----
MNP ALARM STATUS = ** 0547 Service degraded
```

```
LNP SUBSYSTEM REPORT   IS-NR           Active   -----
  LNP:   SSN STATUS    = Allowed     MATE SSN STATUS = -----
  LNP ALARM STATUS     = ** 0283 LNP Ported LRNs approaching
```

Feat. Cap.

```
INPQ SUBSYSTEM REPORT  IS-ANR           Active   -----
  INPQ:  SSN STATUS    = Allowed     MATE SSN STATUS = -----
  INP ALARM STATUS     = ** 0428 INP Subsystem degraded, cards
```

abnormal

```
SCCP Cards Configured=28      Cards IS-NR=27
System Daily Peak SCCP Load   4134   TPS 15-06-24 07:13:24
System Overall Peak SCCP Load 4134   TPS 15-06-24 07:13:24
System Total SCCP Capacity    135000 TPS (135000 max SCCP
Capacity)
System SCCP Capacity Calc. Method (N)
System TPS Alarm Threshold    108000 TPS ( 80% System  N SCCP
Capacity)
```

CARD	VERSION	PST	SST	AST	MSU USAGE	CPU USAGE	DATA TYPE
1317	135-052-000	IS-NR	Active	-----	2%	5%	ELAP
2211	135-052-000	IS-NR	Active	-----	1%	9%	GTT
2217	135-052-000	IS-NR	Active	-----	20%	10%	ELAP
2305	135-052-000	IS-NR	Active	-----	1%	3%	IMSI
2311	135-052-000	IS-NR	Active	-----	0%	1%	IMSI
2317	135-052-000	IS-NR	Active	-----	2%	2%	ELAP
3103	135-052-000	IS-NR	Active	-----	2%	5%	ELAP
3111	135-052-000	IS-NR	Active	-----	0%	5%	DN
3201 P	135-052-000	IS-NR	Active	-----	2%	5%	ELAP
3203	135-052-000	IS-NR	Active	-----	2%	2%	ELAP
3205	135-052-000	IS-NR	Active	-----	2%	2%	ELAP
3207	135-052-000	IS-NR	Active	-----	2%	5%	ELAP
3217	135-052-000	IS-NR	Active	-----	2%	5%	ELAP
4107	135-052-000	IS-NR	Active	-----	0%	4%	IMSI
4111	135-052-000	IS-NR	Active	-----	0%	9%	GTT
4207 P	135-052-000	IS-NR	Active	-----	1%	5%	DN
4311	-----	OOS-MT	Isolated	-----	0%	0%	DN
5211	135-052-000	IS-NR	Active	-----	1%	5%	IMSI
5307	135-052-000	IS-NR	Active	-----	1%	9%	GTT
5317	135-052-000	IS-NR	Active	-----	20%	4%	ELAP
6101	135-052-000	IS-NR	Active	-----	2%	2%	ELAP
6105	135-052-000	IS-NR	Active	-----	2%	2%	ELAP
6107	135-052-000	IS-NR	Active	-----	2%	2%	ELAP
6111	135-052-000	IS-NR	Active	-----	2%	2%	ELAP
6113	135-052-000	IS-NR	Active	-----	2%	3%	ELAP
6115	135-052-000	IS-NR	Active	-----	2%	5%	ELAP
6117	135-052-000	IS-NR	Active	-----	2%	5%	ELAP
1107	135-052-000	IS-NR	Active	-----	2%	2%	ELAP

```
SCCP Service Average MSU Capacity = 2%   Average CPU Capacity = 4%
```

```
AVERAGE CPU USAGE PER SERVICE:
GTT   = 1%  MNP   = 0%
```

```
LNPMPR = 1% LNPQS = 1% WNPQS = 1% TLNP = 1% PLNPQS
= 1%
LRNQTT = 0% INPMPR = 0%
```

TOTAL SERVICE STATISTICS:

SERVICE	SUCCESS	ERRORS	FAIL RATIO	REROUTE\ WARNINGS	FORWARD TO GTT
TOTAL					
GTT:	111	0	0%	-	
-	111				
MNP:	0	0	0%	0	
0	0				
LNPMPR:	1602	0	0%	-	
-	1602				
LNPQS:	109065	32	0%	-	-
109097					
WNPQS:	1266	0	0%	-	
-	1266				
TLNP:	725	0	0%	-	
-	725				
PLNPQS:	8817	0	0%	-	
-	8817				
LRNQTT:	0	0	0%	-	
-	0				
INPMPR:	0	0	0%	0	
0	0				
INPQ:	0	0	0%	0	
-	0				

 **Note:**

The `rept-stat-sccp` command output contains other fields that are not used by this procedure. If you wish to see all the fields displayed by the `rept-stat-sccp` command, refer to the `rept-stat-sccp` command description in *Commands User's Guide*.

Table 2-34 shows the maximum number of service modules that can be provisioned based on the type of SCCP traffic the EAGLE is handling and whether or not the Throughput Capacity or the EAGLE SCCP Capacity Increase features are enabled and turned on.

Table 2-34 SCCP Transactions Per Second

Type of Traffic	Maximum Transactions per Second for the EAGLE	Transactions per Second for each Service Module	Maximum Number of Service Modules
Throughput Capacity Feature for either 5000 or 6800 SCCP Transactions per Second is not Enabled or Turned On			

Table 2-34 (Cont.) SCCP Transactions Per Second

Type of Traffic	Maximum Transactions per Second for the EAGLE	Transactions per Second for each Service Module	Maximum Number of Service Modules
GTT Traffic or ANSI41 AIQ only - No EPAP-Based Traffic or ELAP-Based (LNP) Traffic	52,700	1700	32
ELAP-Based (LNP) Traffic	40,800	1700	25
EPAP-Based Traffic	40,800	1700 - for a SLIC card	25
	20,400	850 - for a DSM	25
Throughput Capacity Feature for 5000 SCCP Transactions per Second is Enabled and Turned On (See Notes 1 and 2)			
GTT Traffic or ANSI41 AIQ only - No EPAP-Based Traffic or ELAP-Based (LNP) Traffic	150,000	5000	32
ANSI G-Flex EPAP-Based Traffic Only	150000	5000	32
EPAP-Based Traffic (except ANSI G-Flex Traffic)	96,875	3125	32
ELAP-Based (LNP) Traffic	85,000	5000	18 (See Note 3)
Throughput Capacity Feature for 6800 SCCP Transactions per Second is Enabled and Turned On (See Notes 1 and 2)			
GTT Traffic or ANSI41 AIQ only - No EPAP-Based Traffic or ELAP-Based (LNP) Traffic	210,800	6800	32
EPAP-Based Traffic (including ANSI G-Flex Traffic)	210,800	6800	32
ELAP-Based (LNP) Traffic	115,600	6800	18 (See Note 3)
Throughput Capacity Feature for 10000 SCCP Transactions per Second is Enabled and Turned On (See Note 4)			
GTT Traffic or ANSI41 AIQ	310,000	10000	32

Table 2-34 (Cont.) SCCP Transactions Per Second

Type of Traffic	Maximum Transactions per Second for the EAGLE	Transactions per Second for each Service Module	Maximum Number of Service Modules
Notes:			
<p>a. To achieve the maximum transactions per second shown in this portion of the table, all the service modules must be SLIC cards.</p> <p>b. The value shown in the Transactions per Second for each Service Module column in this portion of the table applies only to SLIC cards.</p> <p>c. The number of service modules can be a maximum of 18 only if the ELAP version is 9.0. If the ELAP version is less than 9.0, only nine service modules can be used for ELAP-based traffic.</p> <p>d. Throughput Capacity feature for 10000 TPS requires E5-SM8G-B cards, and 13.6k TPS requires SLIC cards.</p>			

Table 2-35 shows the maximum SCCP throughput capacity based on the combinations of features and GPL/card.

Table 2-35 SCCP Throughput Capacity

SCCP Throughput Capacity Feature Activated	E5-SM8G-B TPS	SLIC TPS
13.6K TPS (P/N: 893019104)	13600	13600 TPS if all below conditions are true: <ul style="list-style-type: none"> a. EGMS feature is not activated b. EPAP240M option in STPOPTS is OFF or SM card is provisioned as data=DN/IMSI/ELAP/GTT c. No UAM 548 or 549 present in the system <p>10000 TPS if any of the below conditions are true:</p> <ul style="list-style-type: none"> a. EGMS feature is activated. b. EPAP240M option in STPOPTS is ON and SM card is not provisioned as data=DN/IMSI/ELAP/GTT c. UAM 548 or 549 is present in the system
10K TPS (P/N: 893019103)	10000	10000
6.8K TPS (P/N: 893019102)	6800	6800
5K TPS (P/N: 893019101)	5000	5000

The EAGLE's total SCCP throughput capacity can be calculated as the number of SCCP cards in the system (N) times the SCCP throughput capacity per card (keeping in mind the SCCP configuration of the system: N or N+1). The number of SCCP cards in the system depends on whether the system is a pure GTT or EPAP or ELAP system and the specific EAGLE/EPAP/ELAP release.

Table 2-36 Number Service Module Cards in the System

MPS Release	SM4G Cards (up to 5K/6.8K/10KTPS)
ELAP 10.0	18 Up to 384 mil TNs
Up to EAGLE 41.1+ EPAP 16	25
From EAGLE 42.0 + EPAP 16 on AS T1000	25 (in N+1 config)
From EAGLE 42.0 +EPAP 16 on AS T1200	32 (in N+1 config)

If the `rept-stat-sccp` output shows that the EAGLE has the maximum number of service modules, as shown in [Table 2-36](#), the remainder of this procedure cannot be performed.

If the `rept-stat-sccp` output shows that the EAGLE does not have the maximum number of service modules, as shown in [Table 2-36](#), continue the procedure by performing one of these steps.

- If a card is being added, continue the procedure with [7](#).
 - If an E5-SM8G-B card is being added, continue the procedure with [6](#).
6. Verify that HIPR2 cards are installed at card locations 9 and 10 in the shelf where the E5-SM8G-B card will be installed. Enter this command.

```
rept-stat-gpl:gpl=hipr2
```

This is an example of the possible output.

```
rlghncxa03w 09-07-01 11:40:26 GMT EAGLE5 41.1.0
GPL          CARD      RUNNING      APPROVED      TRIAL
HIPR2       1109      126-002-000 126-002-000 126-003-000
HIPR2       1110      126-002-000 126-002-000 126-003-000
HIPR2       1209      126-002-000 126-002-000 126-003-000
HIPR2       1210      126-002-000 126-002-000 126-003-000
HIPR2       1309      126-002-000 126-002-000 126-003-000
HIPR2       1310      126-002-000 126-002-000 126-003-000
HIPR2       2109      126-002-000 126-002-000 126-003-000
HIPR2       2110      126-002-000 126-002-000 126-003-000
Command Completed
```

If HIPR2 cards are installed at card locations 9 and 10 in the shelf where the E5-SM8G-B card will be installed, continue the procedure with [7](#).

If HIPR2 cards are not installed in the shelf where the E5-SM8G-B card will be installed, refer to *Installation Guide* to install the HIPR2 cards. Once the HIPR2 cards have been installed, continue the procedure with [7](#).

7. Verify the service module has been physically installed into the proper location according to the feature requirements. [Table 2-31](#) shows the type of service module that is required based on the GTT-related features that are currently

being used (also shown in the `rtrv-feat` output in 2 as being `on`, and in the `rtrv-ctrl-feat` output in 4 as being enabled) and any features that will be enabled after this procedure is performed.

Caution:

If the versions of the flash GPLs on the service module do not match the flash GPL versions in the database when the service module is inserted into the card slot, UAM 0002 is generated to indicate that these GPL versions do not match. If UAM 0002 has been generated, perform the alarm clearing procedure for UAM 0002 in *Unsolicited Alarm and Information Messages Reference* before proceeding with this procedure.

8. Verify the EAGLE has a fan unit and the fan unit is on. If the fan unit is not on, use the `enable-ctrl-feat:fan=on` command to turn on the fan.
9. Verify the MFC STP option is turned on. If the MFC STP option is not turned on, use the `enable-ctrl-feat:MFC=on` to turn it on.
10. Add the service module to the database using the `ent-card` command. For this example, enter this command.

```
ent-card:loc=1301:type=dsm:appl=vsccp
```

Note:

If any EPAP-based feature is enabled and turned on, and the service module quantity will exceed 25, the `ent-card` command must be entered twice within 30 seconds on the same terminal for the service module to be added to the database.

When this command has completed, one of these messages should appear.

- If any of these conditions will be present after the new service module is added to the database:
 - the total number of service modules will not be increased beyond 25
 - the total number of service modules will be greater than 25 and no EPAP-based features are enabled and turned on (see [Table 2-33](#))
 - the total number of service modules will be from 27 to 32 and any EPAP-based features are enabled and turned on (see [Table 2-33](#))

this message should appear.

```
rlghncxa03w 10-07-25 09:57:51 GMT EAGLE5 42.0.0
ENT-CARD: MASP A - COMPLTD
```

- If the addition of the new service module will increase the total number of service modules to 26 and any EPAP-based features are enabled and turned on (see [Table 2-33](#)), this message should appear.

```
rlghncxa03w 10-07-25 09:57:51 GMT EAGLE5 42.0.0
```

CAUTION: Please ensure EPAP Application Server is running on hardware supporting 32 SCCP cards e.g.: T1200.

Re-enter command within 30 seconds to confirm change.

```
rlghncxa03w 10-07-25 09:57:51 GMT EAGLE5 42.0.0
ENT-CARD: MASP A - Command Aborted
```

After this message appears, re-enter the `ent-card` command within 30 seconds. This message should appear.

```
rlghncxa03w 10-07-25 09:57:51 GMT EAGLE5 42.0.0
ENT-CARD: MASP A - COMPLTD
```

If the `ent-card` command is not re-entered within 30 seconds, this message should appear and the new service module will not be added to the database.

ENT-CARD command (Type=DSM) confirmation timer expired

11. Verify the changes using the `rtrv-card` command with the card location specified. For this example, enter this command.

```
rtrv-card:loc=1301
```

This is an example of the possible output.

```
rlghncxa03w 09-07-25 09:58:31 GMT EAGLE5 41.1.0
CARD   TYPE      APPL      LSET NAME      LINK SLC LSET NAME
LINK SLC
1301   DSM          VSCCP
```

12. Display the current IP link parameters associated with the Service Module card in the database by entering the `rtrv-ip-lnk` command:

```
RLGHNCXA03W 05-14-24 21:14:37 GMT EAGLE 46.0.0
LOC PORT IPADDR SUBMASK DUPLEX SPEED MACTYPE AUTO MCAST
1107 A ----- ----- HALF 10 DIX NO NO
1107 B ----- ----- HALF 10 DIX NO NO
```

13. Enter the IP address and other parameter values associated with the Service Module card in the database using the `chg-ip-lnk` command:

For example, enter:

```
chg-ip-
lnk:loc=1107:port=a:ipaddr=192.168.122.1:mactype=dix:auto=yes
s: mcast=yes:submask=255.255.255.0
```

```
chg-ip-
lnk:loc=1107:port=b:ipaddr=192.168.123.1:mactype=dix:auto=yes
s: mcast=yes:submask=255.255.255.0
```

Where:

:loc

Card location or slot number of the SM card in the EAGLE

:port

Ethernet interface Port ID-the physical interface of the SM card

:ipaddr

IP address for the specified port. This is a TCP/IP address expressed in standard dot notation. IP addresses consist of the network number of the system and the unique host number.

:submask

Subnet mask of the IP interface in the form of an IP address with a restricted range of values

:mactype

Media Access Control Type of the interface. When a Service Module card is entered into the database, these values are automatically configured.

:mcast

Multicast Control to enable or disable multicast support for the interface. This parameter value must be yes to establish the connection from the SM card to the MPS system.

:auto

Tells hardware whether to automatically determine duplex and speed.

 **Note:**

Corresponding ports on ExAP LAN switches should be configured accordingly to achieve the required operational speed and duplex of 1Gbps and Full Duplex. Refer to *ExAP Administration Guide* for more information. Once the SM (SMxG/SLIC) card is in service, the pass command `pass:cmd="netstat -i":loc=<:SM card loc>` can be used to verify the operational speed and duplex of ExAP ports on SM cards.

14. Verify the IP address and other parameter values associated with the Service Module card in the database by entering the `rtrv-ip-lnk` command:

```
RLGHNCXA03W 05-14-24 21:14:37 GMT EAGLE 46.0.0
LOC PORT IPADDR SUBMASK DUPLEX SPEED MACTYPE AUTO MCAST
1107 A 192.168.122.1 255.255.255.0 HALF 100 DIX NO YES
1107 B 192.168.123.1 255.255.255.0 HALF 10 DIX NO YES
```

15. Display the current IP host information in the database by entering the `rtrv-ip-host` command:

```
RLGHNCXA03W 05-14-24 21:17:37 GMT EAGLE 46.0.0
IPADDR HOST
192.1.1.32 KC_HLR2
192.1.1.50 DN_MSC1
192.1.1.52 DN_MSC2
```

16. Add the host name and IP address for each VSCCP link, using the `ent-ip-host` command.

Command examples:

```
ent-ip-host:host=vsccp_1107_a:ipaddr=192.168.122.1
ent-ip-host:host=vsccp_1107_b:ipaddr=192.168.123.1
```

Where:

:host

Host name. Each VSCCP link must be specified separately.

:ipaddr

IP network address for each EPAP. The first three octets of the IP address must be the same as MPS A and B ports, respectively. The fourth octet identifies the SM card and must have a unique octet identifier for the card IP address

17. Verify the new IP host information in the database by entering the `rtrv-ip-host` command:

```
RLGHNCXA03W 05-14-24 21:19:37 GMT EAGLE 46.0.0
IPADDR HOST
192.1.1.32 KC_HLR2
192.1.1.50 DN_MSC1
192.1.1.52 DN_MSC2
192.168.122.1 VSCCP_1107_A
192.168.123.1 VSCCP_1107_B
```

18. Enter local domain and IP router address for the SM card using the `chg-ip-card` command:

 **Note:**

Most customer private networks do not require setting up a default router for the SM card. If your network configuration requires a default router to connect the Service Module card communication to the EPAP, then only one default router is assignable to each Service Module card. Assign the default router address to each Service Module card as shown in this step.

For example:

```
chg-ip-card:defrouter=192.168.122.250:domain=nc.tekelec.com:loc=<card location>
```

Where:

:defrouter

Default router IP address. This is a TCP/IP address expressed in standard dot notation. IP addresses consist of the network number of the system and the unique host number.

:domain

Domain name of domain server

:loc

Card location or slot number of the SM card in the EAGLE

19. Verify the new TCP/IP parameters associated with the SM card in the database by entering the `rtrv-ip-card` commands:

```
RLGHNCXA03W 05-14-24 21:21:37 GMT EAGLE 45.0.0
LOC 1107
SRCHORDR LOCAL
DNSA -----
DNSB -----
DEFROUTER 192.168.122.250
DOMAIN NC.TEKELEC.COM
```

20. Allow the SM card that was added to operate in the system, using the `alw-card` command:

```
alw-card:loc=<card location>
```

21. Verify the In-Service-Normal (IS-NR) status of the SM card, using the `rept-stat-card` command.

22. Test the presence of the EPAP hosts on the network using the `pass` command with the `ping` parameter. This command is invoked with a destination that is either a hostname or IP address.

Command examples:

```
pass:loc=1107:cmd="ping 192.168.122.100"
```

```
pass:loc=1107:cmd="ping 192.168.122.200"
```

```
pass:loc=1107:cmd="ping 192.168.123.100"
```

```
pass:loc=1107:cmd="ping 192.168.123.200"
```

Where:

:loc

Card location or slot number in the EAGLE

:cmd

Command string passed to Service Module card for processing.

After successful completion of each command, the system response is similar to the following output:

```
rlghncxa03w 05-14-24 08:30:44 GMT EAGLE 46.0.0
pass: loc=1107: cmd="ping 192.168.122.100"
Command entered at terminal #1.
;
rlghncxa03w 05-14-24 08:30:44 GMT EAGLE 46.0.0
PASS: Command sent to card
;
rlghncxa03w 05-14-24 08:30:44 GMT EAGLE 46.0.0
PING command in progress
;
rlghncxa03w 05-14-24 08:30:46 GMT EAGLE 46.0.0
```



```
PING 192.168.122.100: 56 data bytes
64 bytes from tekral.nc.tekelec.com
(192.168.122.100):icmp_seq=0.time=5. ms
64 bytes from tekral.nc.tekelec.com
(192.168.122.100):icmp_seq=1.time=0. ms
64 bytes from tekral.nc.tekelec.com
(192.168.122.100):icmp_seq=2.time=0. ms
----192.168.100.3 PING Statistics----
3 packets transmitted, 3 packets received, 0% packet loss
round-trip (ms) min/avg/max = 0/1/5
PING command complete
```

If the `pass` commands with the `ping` parameter are not successful, verify the correct connection of the hardware cabling and repeat this step. If the command fails again, contact the [#unique_17](#).

- Put the card in service using the `rst-card` command with the card location specified in . For this example, enter this command.

```
rst-card:loc=1301
```

 **Note:**

The primary state of the service module will remain `IS-ANR` and the secondary state of the service module will remain `MPS_UNAVAIL` after the `rst-card` command is performed when these conditions are present.

- An EPAP-based feature is enabled and turned on.
- Adding the new service module increased the service module quantity beyond 25.

When this command has successfully completed, this message should appear.

```
rlghncxa03w 09-07-28 08:21:07 GMT EAGLE5 41.1.0
Card has been allowed.
```

Continue the procedure by performing one of these steps.

- If the EGTT feature is on, shown by the entry `EGTT = on` in the `rtrv-feat` command output in , or if the EGTT feature is off and will not be turned on in this procedure, continue the procedure with .
 - If the EGTT feature is off and will be turned on in this procedure, continue the procedure with .
- Turn the enhanced global title translation feature on by entering this command.

 **Note:**

Once the Enhanced Global Title Translation (EGTT) feature is turned on with the `chg-feat` command, it cannot be turned off. The EGTT feature must be purchased before turning it on. If you are not sure whether you have purchased the EGTT feature, contact your Sales Representative or Account Representative.

When the `chg-feat` has successfully completed, this message should appear.

```
rlghncxa03w 09-07-25 09:57:41 GMT EAGLE5 41.1.0  
CHG-FEAT: MASP A - COMPLTD
```

25. Back up the new changes using the `chg-db:action=backup:dest=fixed` command. These messages should appear, the active Maintenance and Administration Subsystem Processor (MASP) appears first.

```
BACKUP (FIXED) : MASP A - Backup starts on active MASP.  
BACKUP (FIXED) : MASP A - Backup on active MASP to fixed disk  
complete.  
BACKUP (FIXED) : MASP A - Backup starts on standby MASP.  
BACKUP (FIXED) : MASP A - Backup on standby MASP to fixed disk  
complete.
```

Figure 2-37 Add a Service Module - Sheet 1 of 4

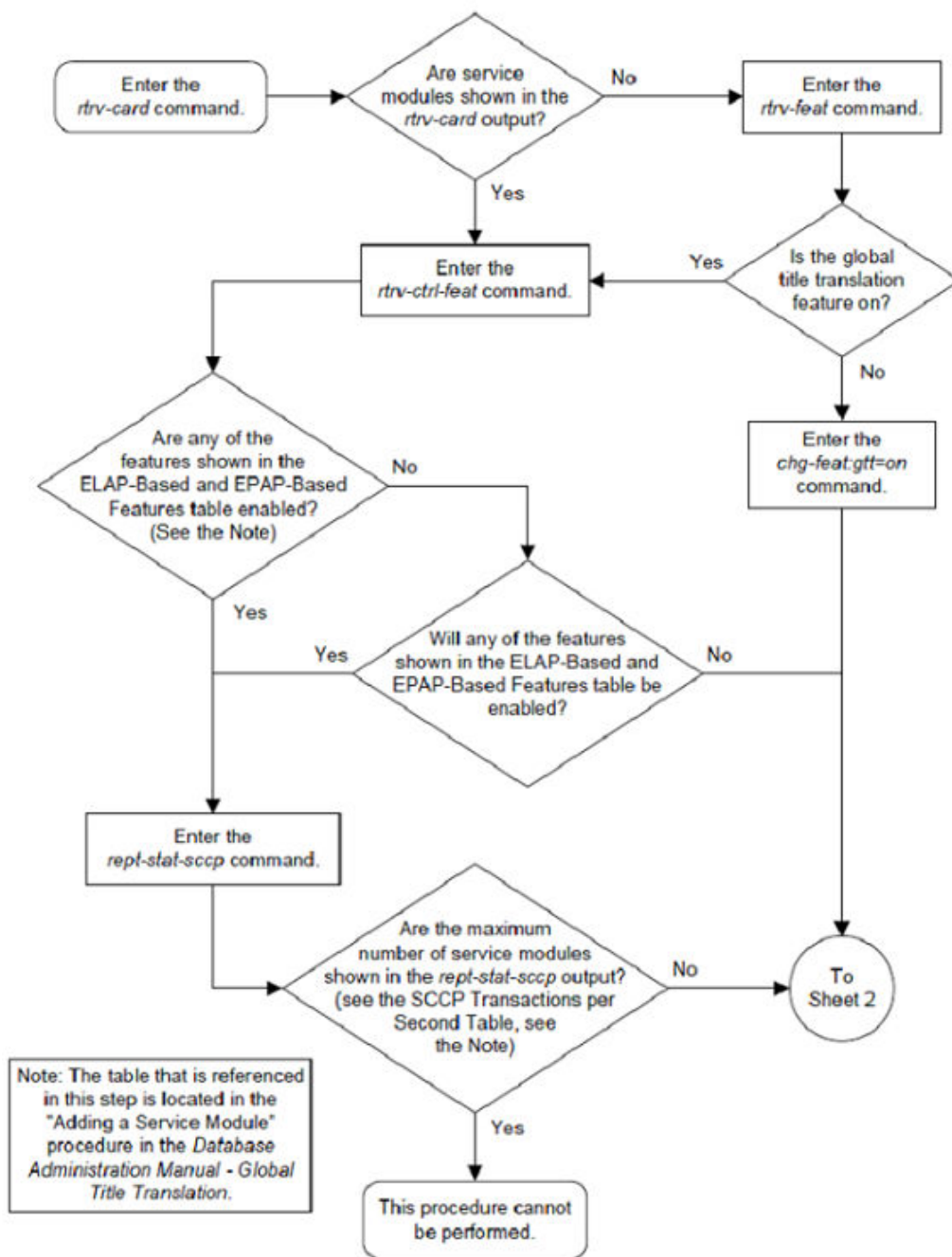

Figure 2-38 Add a Service Module - Sheet 2 of 4

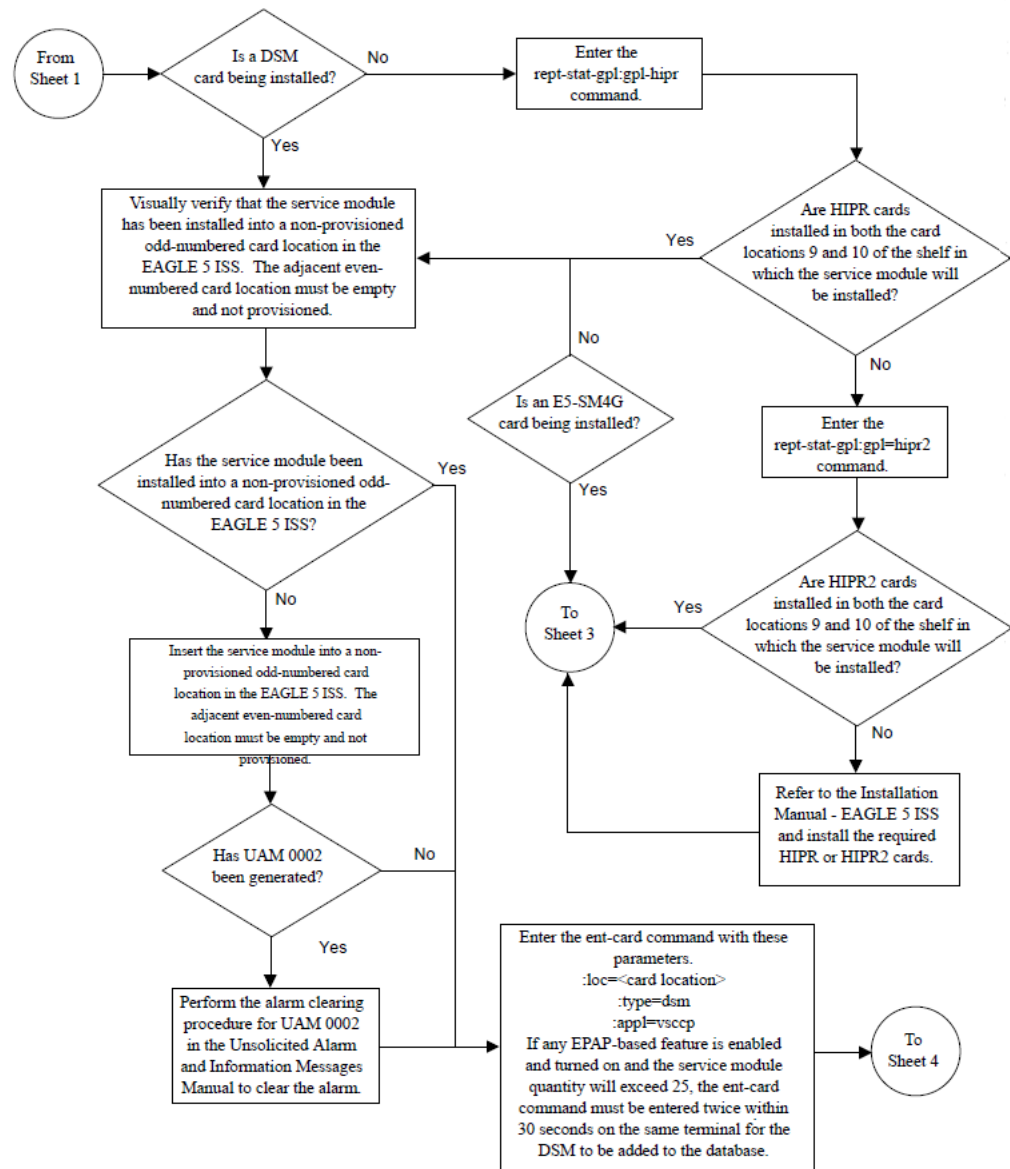

Figure 2-39 Add a Service Module - Sheet 3 of 4

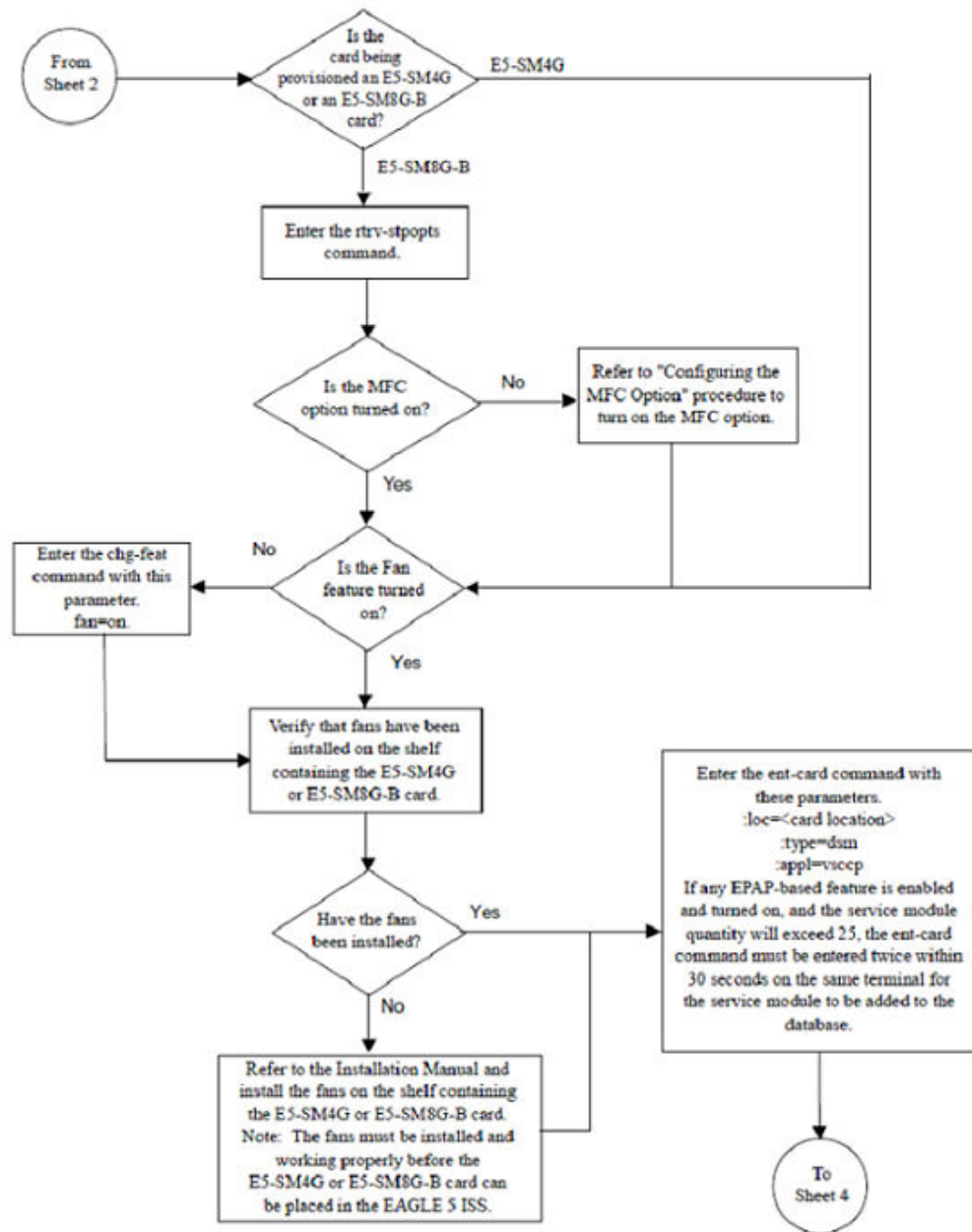
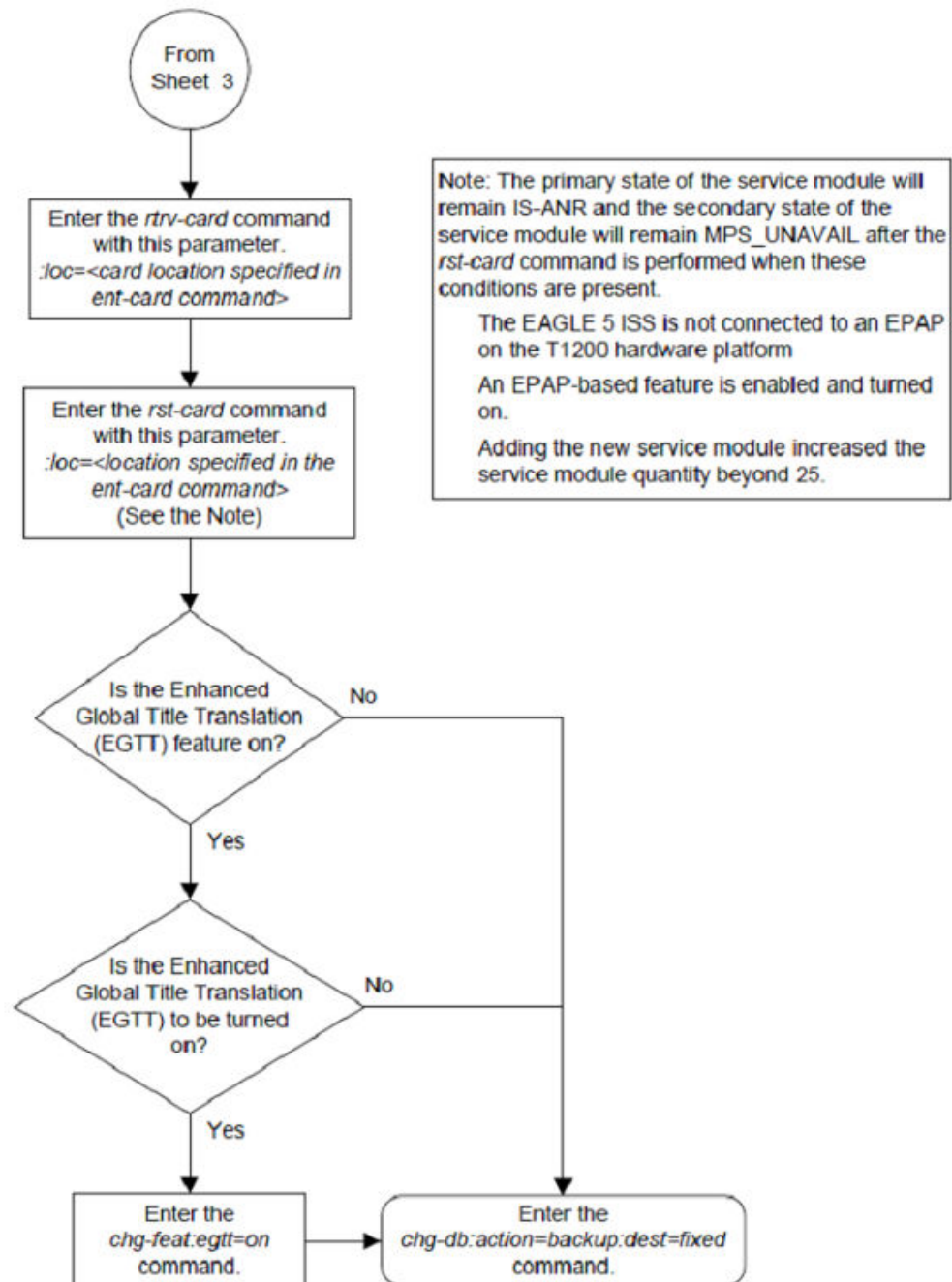

Figure 2-40 Add a Service Module - Sheet 4 of 4



Removing a Service Module

This procedure is used to remove a service module, used by global title translation, from the database using the *dlr-card* command. The card cannot be removed if it does not exist in the database.

▲ Caution:

If the service module is the last service module in service, removing this card from the database will cause global title translation traffic to be lost.

The examples in this procedure are used to remove the service module in card location 1204.

1. Display the status of the service modules by entering the `rept-stat-sccp` command.

This is an example of the possible output.

```
rlghncxa03w 06-10-25 09:57:31 GMT EAGLE5 36.0.0

CARD  VERSION      PST           SST           AST           MSU USAGE
CPU  USAGE
-----
-----
2101  113-002-001  IS-NR        Active        -----
47%      81%
2103  113-002-001  IS-NR        Active        -----
34%      50%
2111  113-002-001  IS-NR        Active        -----
21%      29%
2115  113-002-001  IS-NR        Active        -----
35%      52%
2117  113-002-001  IS-NR        Active        -----
40%      71%
-----
-----
SCCP Service Average MSU Capacity = 36%      Average CPU Capacity
= 56%
Command Completed.
```

✎ Note:

The `rept-stat-sccp` command output contains other fields that are not used by this procedure. If you wish to see all the fields displayed by the `rept-stat-sccp` command, refer to the `rept-stat-sccp` command description in *Commands User's Guide*.

2. Remove the card from service using the `rmv-card` command and specifying the card location.

If the service module to be inhibited is the only service module in service, the `force=yes` parameter must also be specified. The cards that are in service are shown by the entry `IS-NR` in the `PST` field in the output in 1. For this example, enter this command.

```
rmv-card:loc=1204
```

When this command has successfully completed, this message should appear.

```
rlghncxa03w 06-10-25 09:57:41 GMT EAGLE5 36.0.0  
Card has been inhibited.
```

3. Remove the card from the database using the `dlt-card` command.

The `dlt-card` command has only one parameter, `loc`, which is the location of the card. For this example, enter this command.

```
dlt-card:loc=1204
```

When this command has successfully completed, this message should appear.

```
rlghncxa03w 06-10-25 09:57:51 GMT EAGLE5 36.0.0  
DLT-CARD: MASP A - COMPLTD
```

4. Verify the changes using the `rtrv-card` command specifying the card that was removed in 2.

For this example, enter this command.

```
rtrv-card:loc=1204
```

When this command has successfully completed, this message should appear.

```
E2144 Cmd Rej: Location invalid for hardware configuration
```

5. Backup the new changes using the `chg-db:action=backup:dest=fixed` command.

These messages should appear, the active Maintenance and Administration Subsystem Processor (MASP) appears first.

```
BACKUP (FIXED) : MASP A - Backup starts on active MASP.  
BACKUP (FIXED) : MASP A - Backup on active MASP to fixed disk  
complete.  
BACKUP (FIXED) : MASP A - Backup starts on standby MASP.  
BACKUP (FIXED) : MASP A - Backup on standby MASP to fixed disk  
complete.
```

Figure 2-41 Remove a Service Module

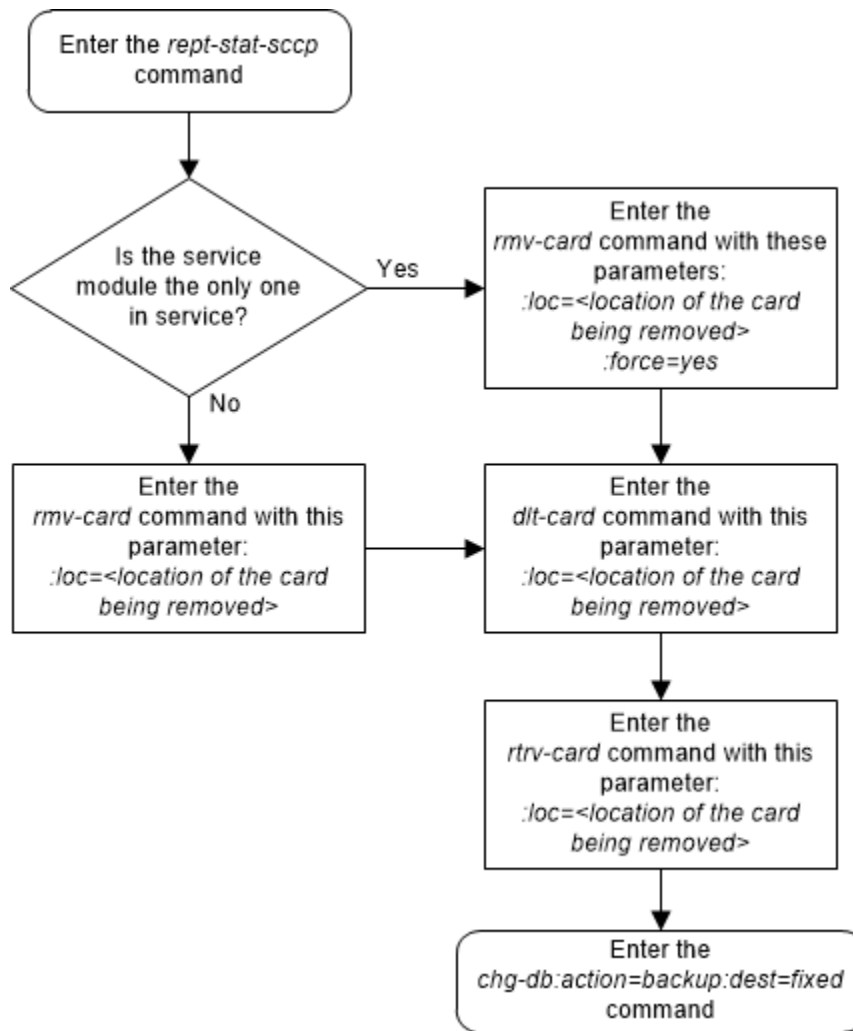

Adding a Mapped SS7 Message Translation Type

This procedure is used to add a mapped SS7 message translation type to the database. The mapped translation type is added to the database using the `ent-ttmap` command and is assigned to an ANSI SS7 linkset.

The `ent-ttmap` command uses these parameters.

`:lsn` – the name of the linkset.

`:io` – is translation type mapping to be performed on SS7 messages received in the linkset (incoming linkset) or on SS7 messages sent on the linkset (outgoing linkset).

`:ett` – the translation type contained in the SS7 message before that translation type is mapped.

`:mtt` – the translation type that the value of the `ett` parameter is mapped to.

The examples in this procedure are used to map the SS7 message translation type 250 to the translation type 001 for any incoming messages on linkset `lsn01`.

Canceling the RTRV-LS Command

Because the `rtrv-ls` command used in this procedure can output information for a long period of time, the `rtrv-ls` command can be canceled and the output to the terminal stopped. There are three ways that the `rtrv-ls` command can be canceled.

- Press the F9 function key on the keyboard at the terminal where the `rtrv-ls` command was entered.
- Enter the `canc-cmd` without the `trm` parameter at the terminal where the `rtrv-ls` command was entered.
- Enter the `canc-cmd:trm=<xx>`, where `<xx>` is the terminal where the `rtrv-ls` command was entered, from another terminal other than the terminal where the `rtrv-ls` command was entered. To enter the `canc-cmd:trm=<xx>` command, the terminal must allow Security Administration commands to be entered from it and the user must be allowed to enter Security Administration commands. The terminal's permissions can be verified with the `rtrv-secu-trm` command. The user's permissions can be verified with the `rtrv-user` or `rtrv-secu-user` commands.

For more information about the `canc-cmd` command, go to *Commands User's Guide*.

1. Display the mapped translation types in the database using the `rtrv-ttmap` command.

This is an example of the possible output.

```
rlghncxa03w 07-05-25 09:57:31 GMT EAGLE5 37.0.0
LSN      IO  ETT  MTT
nc001    I   047  032
nc001    I   128  055
nc001    I   238  128
nc001    I   254  016
nc001    O   016  254
nc001    O   128  238
```

2. Display the linksets in the database using the `rtrv-ls` command. This is an example of the possible output.

```
rlghncxa03w 09-05-25 09:57:41 GMT EAGLE5 41.0.0

LSN      APCA  (SS7)  SCRN  L3T  SLT  BEI  LST  LNKS  GWS  GWS  GWS
SLSCI  NIS
lsa1    240-020-000  scr1  1    1  yes  a   1    off  off  off
no     off
lsa2    240-030-000  scr2  1    2  no   c   3    on   on   on
yes    off
lsa3    240-040-000  scr3  1    3  yes  c   5    off  off  off
yes    off
lsn01   240-050-000  scr4  1    3  yes  c   5    off  off  off
yes    off
nc001   240-060-000  scr5  1    3  yes  c   5    off  off  off
yes    off

L3T  SLT          GWS  GWS  GWS
```

```

LSN          APCI (SS7)   SCRNL3T SLT          GWS GWS GWS
SLSCI NIS
lsi1         1-111-1   scr1  1    1  yes a  1    off off off
---         ---
lsi2         1-111-2   scr2  1    2  no  c  3    on  on  on
---         ---
lsi3         1-111-3   scr3  1    3  yes c  5    off off off
---         ---

```

```

LSN          APCN (SS7)   SCRNL3T SLT          GWS GWS GWS
SLSCI NIS
lsn1         11111   scr1  1    1  yes a  1    off off off
--- off
lsn2         11112   scr2  1    2  no  c  3    on  on  on
--- off
lsn3         11113   scr3  1    3  yes c  5    off off off
--- off

```

Link set table is (11 of 1024) 1% full

If the required linkset is not in the database, perform the “Adding an SS7 Linkset” procedure in *Database Administration - SS7 User's Guide* and add the linkset.

3. Add the mapped translation type to the database using the `ent-ttmap` command. For this example, enter this command.

```
ent-ttmap:lsn=lsn01:io=i:ett=001:mtt=250
```

When this command has successfully completed, this message should appear.

```
rlghncxa03w 07-05-25 09:57:51 GMT EAGLE5 37.0.0
ENT-TTMAP: MASP A - COMPLTD
```

TTMAP table for lsn01 is (1 of 64) 1% full

4. Verify the changes using the `rtrv-ttmap` command. This is an example of the possible output.

```
rlghncxa03w 07-05-25 09:58:31 GMT EAGLE5 37.0.0
LSN      IO  ETT  MTT
lsn01    I   001  250
nc001    I   047  032
nc001    I   128  055
nc001    I   238  128
nc001    I   254  016
nc001    O   016  254
nc001    O   128  238
```

5. Back up the new changes using the `chg-db:action=backup:dest=fixed` command. These messages should appear, the active Maintenance and Administration Subsystem Processor (MASP) appears first.

```
BACKUP (FIXED) : MASP A - Backup starts on active MASP.
BACKUP (FIXED) : MASP A - Backup on active MASP to fixed disk
```

complete.
 BACKUP (FIXED) : MASP A - Backup starts on standby MASP.
 BACKUP (FIXED) : MASP A - Backup on standby MASP to fixed disk
 complete.

Figure 2-42 Add a Mapped SS7 Message Translation Type

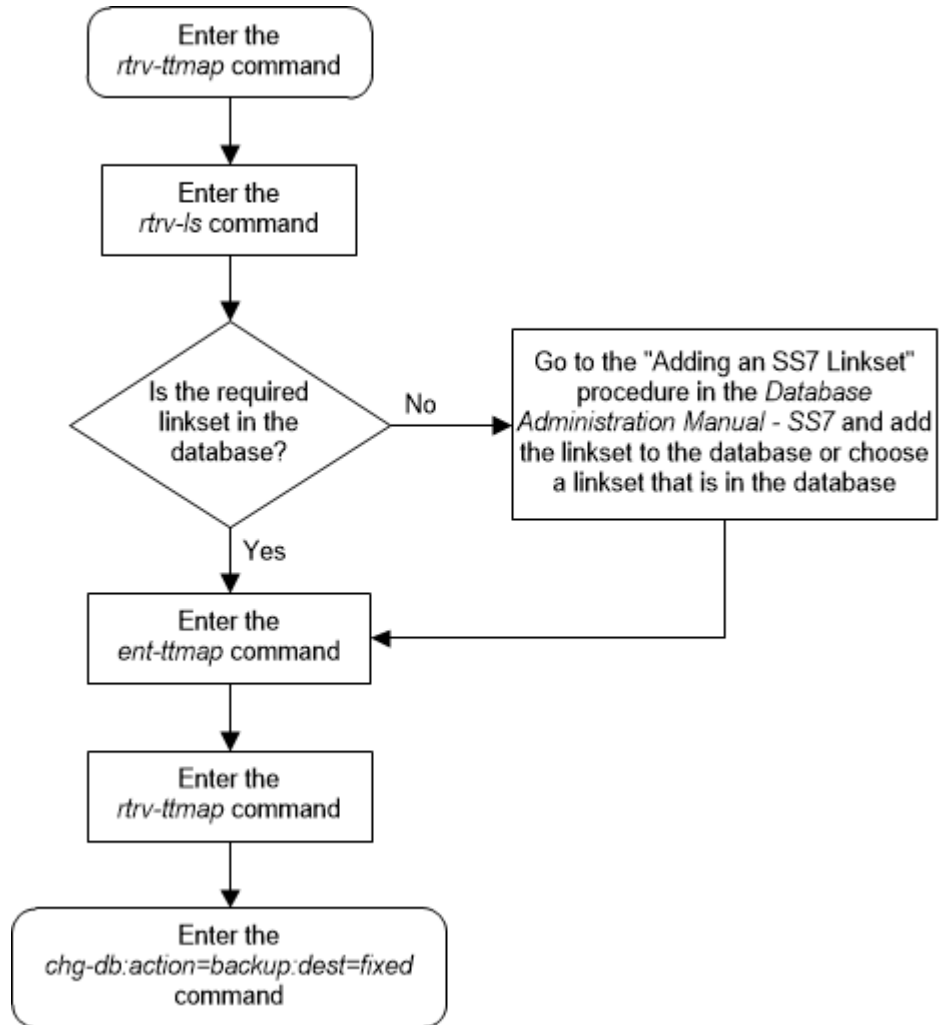

Removing a Mapped SS7 Message Translation Type

This procedure is used to remove a mapped SS7 message translation type from the database using the `dlt-ttmap` command.

The `dlt-ttmap` command uses these parameters.

`:lsn` – the name of the linkset.

`:io` – is translation type mapping to be performed on SS7 messages received in the linkset (incoming linkset) or on SS7 messages sent on the linkset (outgoing linkset).

:ett – the translation type contained in the SS7 message before that translation type is mapped.

The examples in this procedure are used to remove the translation type 016 for any outgoing messages on linkset nc001.

1. Display the mapped translation types in the database using the `rtrv-ttmap` command.

This is an example of the possible output.

```
rlghncxa03w 07-05-25 09:57:31 GMT EAGLE5 37.0.0
LSN      IO  ETT  MTT
lsn01    I   001  250
nc001    I   047  032
nc001    I   128  055
nc001    I   238  128
nc001    I   254  016
nc001    O   016  254
nc001    O   128  238
```

2. Add the mapped translation type to the database using the `dlt-ttmap` command.

For this example, enter this command.

```
dlt-ttmap:lsn=nc001:io=o:ett=016
```

When this command has successfully completed, this message should appear.

```
rlghncxa03w 07-05-25 09:57:41 GMT EAGLE5 37.0.0
DLT-TTMAP: MASP A - COMPLTD
TTMAP table for nc001 is (5 of 64) 8% full
```

3. Verify the changes using the `rtrv-ttmap` command.

This is an example of the possible output.

```
rlghncxa03w 07-05-25 09:57:51 GMT EAGLE5 37.0.0
LSN      IO  ETT  MTT
lsn01    I   001  250
nc001    I   047  032
nc001    I   128  055
nc001    I   238  128
nc001    I   254  016
nc001    O   128  238
```

4. Backup the new changes using the `chg-db:action=backup:dest=fixed` command.

These messages should appear, the active Maintenance and Administration Subsystem Processor (MASP) appears first.

```
BACKUP (FIXED) : MASP A - Backup starts on active MASP.
BACKUP (FIXED) : MASP A - Backup on active MASP to fixed disk
complete.
BACKUP (FIXED) : MASP A - Backup starts on standby MASP.
```

```
BACKUP (FIXED) : MASP A - Backup on standby MASP to fixed disk  
complete.
```

Figure 2-43 Remove a Mapped SS7 Message Translation Type

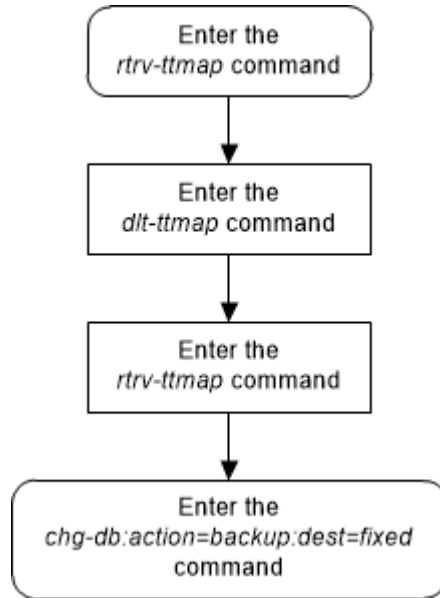

Changing a Mapped SS7 Message Translation Type

This procedure is used to change a mapped SS7 message translation type in the database using the `chg-ttmap` command.

The `chg-ttmap` command uses these parameters.

`:lsn` – the name of the linkset.

`:io` – is translation type mapping to be performed on SS7 messages received in the linkset (incoming linkset) or on SS7 messages sent on the linkset (outgoing linkset).

`:ett` – the translation type contained in the SS7 message before that translation type is mapped.

`:mtt` – the translation type that the value of the `ett` parameter is mapped to.

Only the mapped translation type (`mtt`) can be changed with this procedure. To change the `lsn`, `io`, or `ett` values, the mapped translation type entry has to be removed from the database using the [Removing a Mapped SS7 Message Translation Type](#) procedure, then re-entered with the new `lsn`, `io`, or `ett` values using the [Adding a Mapped SS7 Message Translation Type](#) procedure.

The examples in this procedure are used to change the mapped translation type 250, being mapped for translation type 001 for incoming messages on linkset `lsn01` to mapped translation type 255.

1. Display the mapped translation types in the database using the `rtrv-ttmap` command. This is an example of the possible output.

```
rlghncxa03w 07-05-25 09:57:31 GMT EAGLE5 37.0.0
LSN      IO  ETT  MTT
lsn01    I   001  250
nc001    I   047  032
nc001    I   128  055
nc001    I   238  128
nc001    I   254  016
nc001    O   016  254
nc001    O   128  238
```

2. Change the mapped translation type in the database using the `chg-ttmap` command. For this example, enter this command.

```
chg-ttmap:lsn=lsn01:io=i:ett=001:mtt=255
```

When this command has successfully completed, this message should appear.

```
rlghncxa03w 07-05-25 09:57:41 GMT EAGLE5 37.0.0
CHG-TTMAP: MASP A - COMPLTD
```

```
TTMAP table for lsn01 is (1 of 64) 1% full
```

3. Verify the changes using the `rtrv-ttmap` command. This is an example of the possible output.

```
rlghncxa03w 07-05-25 09:57:51 GMT EAGLE5 37.0.0
LSN      IO  ETT  MTT
lsn01    I   001  255
nc001    I   047  032
nc001    I   128  055
nc001    I   238  128
nc001    I   254  016
nc001    O   016  254
nc001    O   128  238
```

4. Backup the new changes using the `chg-db:action=backup:dest=fixed` command. These messages should appear, the active Maintenance and Administration Subsystem Processor (MASP) appears first.

```
BACKUP (FIXED) : MASP A - Backup starts on active MASP.
BACKUP (FIXED) : MASP A - Backup on active MASP to fixed disk
complete.
BACKUP (FIXED) : MASP A - Backup starts on standby MASP.
BACKUP (FIXED) : MASP A - Backup on standby MASP to fixed disk
complete.
```

Figure 2-44 Change a Mapped SS7 Message Translation Type

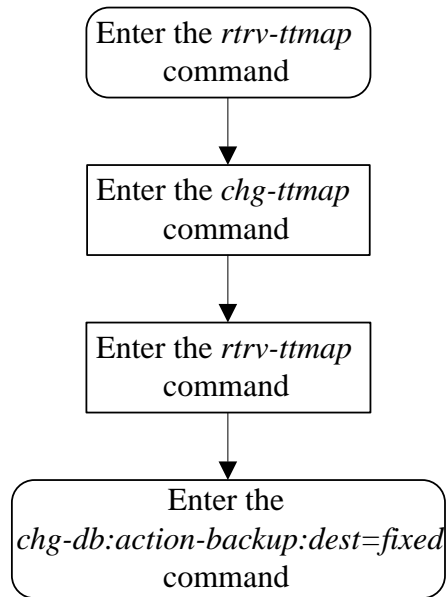

Adding a Concerned Signaling Point Code

This procedure is used to add a concerned signaling point code (CSPC) group to the database using the `ent-cspc` command.

The `ent-cspc` command uses these parameters.

`:grp` – The name of the concerned signaling point code group that contains the point codes that should be notified of the subsystem status.

`:pc/pca/pci/pcn/pcn24` – The point code of the signaling point that is to be in the concerned signaling point code group, either an ANSI point code (`pc/pca`), ITU-I or ITU-I spare point code (`pci`), a 14-bit ITU-N or 14-bit ITU-N spare point code (`pcn`), or a 24-bit ITU-N (`pcn24`) point code.

Note:

Refer to Chapter 2, Configuring Destination Tables in *Database Administration - SS7 User's Guide* for a definition of the point code types that are used on the EAGLE and for a definition of the different formats that can be used for ITU national point codes.

Note:

The EAGLE can contain 14-bit ITU-N point codes or 24-bit ITU-N point codes, but not both at the same time.

The examples in this procedure are used to add the concerned signaling point code (CSPC) groups shown in [Table 2-37](#).

Table 2-37 Concerned Signaling Point Code Configuration Table

CSPC Broadcast Group Name	Concerned Signaling Point Code
grp05	002-002-002
	008-008-008
grp10	008-008-008
	009-009-009
grp15	002-002-002
	009-009-009

The CSPC cannot be in the database for the indicated group.

The point code must exist in the routing table and cannot already exist in the specified group. Verify that the point code is in the routing table by entering the `rtrv-rte` command with the point code. If the point code is an ANSI point code, it must be a full point code. The route must contain a minimum of one active signaling link.

The word “none” cannot be used to name a CSPC group.

The database can contain a maximum of 2550 CSPC groups. Each CSPC group can contain a maximum of 96 concerned signaling point codes.

The mated point codes in the mated application table will not automatically receive CSPC broadcasts unless each mated point code is contained in a CSPC group. A mated application group can contain up to 32 entries, a primary point code and up to 31 mated point codes. Each mated point code in a mated application group can be assigned to a different CSPC group.

The first point code entered for a CSPC group defines the network type for the CSPC group. If the first point code entered for a particular CSPC group is an ANSI point code (`pc` or `pca`), then that CSPC group is an ANSI CSPC group and only ANSI point codes can be added to it. If the first point code in the CSPC group is either an ITU international or ITU international spare point code (`pci`), then the CSPC group is an ITU international CSPC group and only ITU international or ITU international spare point codes can be added to it. If the first point code in the CSPC group is either a 14-bit ITU national or 14-bit ITU national spare point code (`pcn`), then the CSPC group is an ITU national CSPC group and only 14-bit ITU national or 14-bit ITU national spare point codes can be added to it. If the first point code in the CSPC group is a 24-bit ITU national point code (`pcn24`), then the CSPC group is an ITU national CSPC group and only 24-bit ITU national point codes can be added to it.

If the ANSI/ITU SCCP Conversion feature is enabled, CSPC groups can contain ANSI point codes (`pc/pca`), ITU-I or ITU-I spare point codes (`pci`), and either 14-bit ITU-N or 14-bit ITU-N spare point codes (`pcn`), or 24-bit ITU-N (`pcn24`) point codes. A CSPC group cannot contain both 14-bit and 24-bit ITU-N point codes. The status of the ANSI/ITU SCCP Conversion feature can be verified with the `rtrv-ctrl-feat` command.

When the `ent-cspc` command is entered with a CSPC group name and a point code and the CSPC group name does not exist, the command will be rejected. If the group name does not exist, and a point code is not specified, a new group will be created.

1. Display the CSPC group names in the database using the `rtrv-cspc` command. This is an example of the possible output.

```
rlghncxa03w 07-05-25 09:57:31 GMT EAGLE5 37.0.0
CSPC GRP NETWORK PERCENT FULL
grp01 ANSI 6%
grp02 ITU-I 9%
grp03 ITU-N 12%
grp04 ANSI 15%
```

If the ANSI/ITU SCCP Conversion feature is enabled, and multiple network point code types are assigned to CSPC groups, the network types of the point codes in each CSPC group are displayed in the `rtrv-cspc` output as follows in this example.

```
rlghncxa03w 06-10-25 09:57:31 GMT EAGLE5 36.0.0
CSPC GRP NETWORK PERCENT FULL
grp01 ANSI, ITU-I, ITU-N 9%
grp02 ITU-I 9%
grp03 ANSI, ITU-N 6%
grp04 ANSI 15%
```

 **Note:**

If the point code is being added to a new CSPC group, continue the procedure with 3.

2. Display the point codes in the CSPC group that the new point code is being added to by entering the `rtrv-cspc` command with the CSPC group name.

For this example, enter this command.

```
rtrv-cspc:grp=grp01
```

This is an example of the possible output.

```
rlghncxa03w 07-05-25 09:57:31 GMT EAGLE5 37.0.0
CSPC GRP      PCA
grp01         002-002-002
              003-003-003
```

If the ANSI/ITU SCCP Conversion feature is enabled, then point codes of multiple network types can be displayed, if point codes of multiple network types are assigned to the CSPC group, as shown in this example.

```
rlghncxa03w 07-05-25 09:57:31 GMT EAGLE5 37.0.0
CSPC GRP      PC          TYPE
grp01         003-003-003    A
              3-003-3      I
              00112      N
```

3. Enter the `rtrv-rte` command with the `dpca` parameter specifying the point code to be used with the `ent-cspc` command to verify whether or not the point code is the DPC of a route. For this example, enter these commands.

```
rtrv-rte:dpca=002-002-002
```

This is an example of the possible output.

```
rlghncxa03w 07-05-07 11:43:04 GMT EAGLE5 37.0.0
  DPCA          ALIASI      ALIASN/N24    LSN          RC      APCA
  002-002-002  -----  -----  ls02         10
002-002-002
RTX:No  CLLI=ls02clli
```

```
rtrv-rte:dpca=008-008-008
```

This is an example of the possible output.

```
rlghncxa03w 07-05-07 11:43:04 GMT EAGLE5 37.0.0
  DPCA          ALIASI      ALIASN/N24    LSN          RC      APCA
  008-008-008  -----  -----  ls20         10
008-008-008
RTX:No  CLLI=ls20clli
```

```
rtrv-rte:dpca=009-009-009
```

This is an example of the possible output.

```
rlghncxa03w 07-05-07 11:43:04 GMT EAGLE5 37.0.0
  DPCA          ALIASI          ALIASN/N24    LSN          RC          APCA
  009-009-009  -----
009-009-009                                     ls09        10
RTX:No  CLLI=ls09clli
```

If the point code is not shown in the `rtrv-rte` output, perform one the Adding a Route procedures in *Database Administration - SS7 User's Guide* and add the required route to the database. The route must contain a minimum of one active signaling link.

4. Display the signaling links that are in the linksets that are assigned to the route shown in 3 by entering the `rtrv-ls` command with the name of the linksets that are assigned to the route. For this example, enter these commands.

```
rtrv-ls:lsn=ls02
```

This is an example of the possible output.

```
rlghncxa03w 09-07-17 11:43:04 GMT EAGLE5 41.1.0

LSN          APCA  (SS7)  SCRN SET SET BEI LST LNKS ACT MES DIS
SLSCI NIS
ls02         002-002-002  none 1  1  no  A  2  off off off
no  off

          SPCA          CLLI          TFATCABMLQ MTPRSE ASL8
          ----- ls02clli          1          ---  no

RANDSLS
off

IPSG  IPGWAPC  GTTMODE          CGGTMOD
no    no      CdPA          no

          L2T          PCR  PCR
          LOC  PORT  SLC  TYPE  SET  BPS  ECM  N1  N2
          1211 A    0  LIMDS0  1  56000  BASIC  ---  -----
          1211 B    1  LIMDS0  1  56000  BASIC  ---  -----
```

Link set table is (12 of 1024) 1% full.

```
rtrv-ls:lsn=ls20
```

This is an example of the possible output.

```
rlghncxa03w 09-07-17 11:43:04 GMT EAGLE5 41.1.0

LSN          APCA  (SS7)  SCRN SET SET BEI LST LNKS ACT MES DIS
SLSCI NIS
ls20         008-008-008  none 1  1  no  A  2  off off off
```

```

no      off

          SPCA          CLLI          TFATCABMLQ MTPRSE ASL8
-----
          ls20c11i          1          ---          no

RANDSLS
off

IPSG  IPGWAPC  GTTMODE          CGGTMOD
no    no      CdPA          no

          L2T          PCR  PCR
          SET  BPS    ECM  N1  N2
LOC  PORT  SLC  TYPE    SET  BPS    ECM  N1  N2
1212 A    0  LIMDS0  1    56000  BASIC ---  -----
1212 B    1  LIMDS0  1    56000  BASIC ---  -----

```

Link set table is (12 of 1024) 1% full.

```
rtrv-ls:lsn=ls09
```

This is an example of the possible output.

```
rlghncxa03w 09-07-17 11:43:04 GMT EAGLE5 41.1.0
```

```

          L3T SLT          GWS GWS GWS
LSN      APCA  (SS7)  SCRN SET SET BEI LST LNKS ACT MES DIS
SLSCI NIS
ls09     009-009-009  none 1  1  no  A  2  off off off
no      off

          SPCA          CLLI          TFATCABMLQ MTPRSE ASL8
-----
          ls09c11i          1          ---          no

RANDSLS
off

IPSG  IPGWAPC  GTTMODE          CGGTMOD
no    no      CdPA          no

          L2T          PCR  PCR
          SET  BPS    ECM  N1  N2
LOC  PORT  SLC  TYPE    SET  BPS    ECM  N1  N2
1213 A    0  LIMDS0  1    56000  BASIC ---  -----
1213 B    1  LIMDS0  1    56000  BASIC ---  -----

```

Link set table is (12 of 1024) 1% full.

If the linkset does not contain any signaling links, perform one of these procedures in these manuals to add the signaling link.

- *Database Administration – SS7 User's Guide*
 - Adding an SS7 Signaling Link
 - Adding an E1 Signaling Link
 - Adding a T1 Signaling Link

- Adding an ATM High-Speed Signaling Link
- *Database Administration – IP7 User's Guide*
 - Adding an IPLIMx Signaling Link
 - Adding an IPGWx Signaling Link
 - Adding an IPSP M2PA Signaling Link
 - Adding an IPSP M3UA Signaling Link

Make sure the signaling link is placed into service.

Continue the procedure by performing one of these steps.

- If signaling links were added to all the linksets displayed in this step, continue the procedure with 7.
 - If any of the linksets displayed in this step contain signaling links, continue the procedure with 5.
5. Display the status of the signaling links shown in 4 by entering the `rept-stat-slk` command with the signaling link displayed in 4. For this example, enter this command.

```
rept-stat-slk:loc=1211:link=a
```

This is an example of the possible output.

```
rlghncxa03w 09-02-23 13:06:25 GMT EAGLE5 40.1.0
SLK      LSN      CLLI      PST      SST      AST
1211,A  ls02      ls02clli  OOS-MT-DSBLD Manual  ----
  ALARM STATUS      = ** 0236 REPT-LKF: not aligned
  UNAVAIL REASON    = NA
```

```
rept-stat-slk:loc=1211:link=b
```

This is an example of the possible output.

```
rlghncxa03w 09-02-23 13:06:25 GMT EAGLE5 40.1.0
SLK      LSN      CLLI      PST      SST      AST
1211,B  ls02      ls02clli  OOS-MT-DSBLD Manual  ----
  ALARM STATUS      = ** 0236 REPT-LKF: not aligned
  UNAVAIL REASON    = NA
```

```
rept-stat-slk:loc=1212:link=a
```

This is an example of the possible output.

```
rlghncxa03w 09-02-23 13:06:25 GMT EAGLE5 40.1.0
SLK      LSN      CLLI      PST      SST      AST
1212,A  ls20      ls20clli  IS-NR      Avail  ----
  ALARM STATUS      = No Alarms
  UNAVAIL REASON    = --
```

```
rept-stat-slk:loc=1212:link=b
```

This is an example of the possible output.

```
rlghncxa03w 09-02-23 13:06:25 GMT EAGLE5 40.1.0
SLK      LSN      CLLI      PST      SST      AST
1212,B   ls20      ls20clli  IS-NR    Avail    ----
  ALARM STATUS      = No Alarms
  UNAVAIL REASON    = --
```

```
rept-stat-slk:loc=1213:link=a
```

This is an example of the possible output.

```
rlghncxa03w 09-02-23 13:06:25 GMT EAGLE5 40.1.0
SLK      LSN      CLLI      PST      SST      AST
1213,A   ls09      ls09clli  IS-NR    Avail    ----
  ALARM STATUS      = No Alarms
  UNAVAIL REASON    = --
```

```
rept-stat-slk:loc=1213:link=b
```

This is an example of the possible output.

```
rlghncxa03w 09-02-23 13:06:25 GMT EAGLE5 40.1.0
SLK      LSN      CLLI      PST      SST      AST
1213,B   ls09      ls09clli  IS-NR    Avail    ----
  ALARM STATUS      = No Alarms
  UNAVAIL REASON    = --
```

Continue the procedure by performing one of these steps.

- If the state of all the signaling links in a linkset displayed in this step is not IS-NR, continue the procedure with [6](#).
 - If the state of one or more of the signaling links in the linksets displayed in this step is IS-NR, continue the procedure with [7](#).
- 6.** The linkset shown in [5](#) must contain at least active (IS-NR) signaling link. Enter the `act-slk` command to put into service one or more of the signaling links in the linkset. For this example, enter this command.

```
act-slk:loc=1211:link=a
```

When this command has successfully completed, this message should appear.

```
rlghncxa03w 09-02-07 08:31:24 GMT EAGLE5 40.1.0
Activate Link message sent to card
```

Continue the procedure by performing one of these steps.

- If the network type of the point codes being added to the CSPC group will not be the same as the network type of the CSPC group, and multiple point code network types are not shown in the `rtrv-cspc` output in [1](#), continue the procedure with [7](#).
- If the network type of the point codes being added to the CSPC group is the same as the network type of the CSPC group, or if multiple point code network types are shown in the `rtrv-cspc` output in [1](#), continue the procedure with [8](#).

- Verify that the ANSI/ITU SCCP Conversion feature is enabled by entering the `rtrv-ctrl-feat:partnum=893012001` command. The following is an example of the possible output.

```
rlghncxa03w 07-05-28 21:15:37 GMT EAGLE5 37.0.0
The following features have been permanently enabled:
```

Feature Name	Partnum	Status	Quantity
SCCP Conversion	893012001	on	----

The following features have been temporarily enabled:

Feature Name	Partnum	Status	Quantity	Trial Period Left
Zero entries found.				

The following features have expired temporary keys:

Feature Name	Partnum
Zero entries found.	

If the ANSI/ITU SCCP Conversion feature is not enabled, perform the [Activating the ANSI/ITU SCCP Conversion Feature](#) procedure and the ANSI/ITU SCCP Conversion feature.

- Add the concerned signaling point code to the database using the `ent-cspc` command. For this example, enter these commands.

```
ent-cspc:grp=grp05
ent-cspc:grp=grp10
ent-cspc:grp=grp15
ent-cspc:grp=grp05:pca=002-002-002
ent-cspc:grp=grp05:pca=008-008-008
ent-cspc:grp=grp10:pca=008-008-008
ent-cspc:grp=grp10:pca=009-009-009
ent-cspc:grp=grp15:pca=002-002-002
ent-cspc:grp=grp15:pca=009-009-009
```

When each these commands have successfully completed, this message should appear.

```
rlghncxa03w 07-05-25 09:57:41 GMT EAGLE5 37.0.0
ENT-CSPC: MASP A - COMPLTD
```

- Verify the changes using the `rtrv-cspc` command, with the CSPC group names specified in 8. For this example enter these commands.

```
rtrv-cspc:grp=grp05
```

This is an example of the possible output.

```
rlghncxa03w 07-05-25 09:58:31 GMT EAGLE5 37.0.0
CSPC GRP
PCA
grp05          002-002-002
                008-008-008
```

```
rtrv-cspc:grp=grp10
```

This is an example of the possible output.

```
rlghncxa03w 07-05-25 09:59:31 GMT EAGLE5 37.0.0
CSPC GRP      PCA
grp10         008-008-008
                009-009-009
```

```
rtrv-cspc:grp=grp15
```

This is an example of the possible output.

```
rlghncxa03w 07-05-25 09:57:41 GMT EAGLE5 37.0.0
CSPC GRP      PCA
grp15         002-002-002
                009-009-009
```

 **Note:**

If the ANSI/ITU SCCP Conversion feature is enabled, then point codes of multiple network types can be displayed in the `rtrv-cspc` output, if point codes of multiple network types are assigned to the CSPC group.

10. Backup the new changes using the `chg-db:action=backup:dest=fixed` command. These messages should appear, the active Maintenance and Administration Subsystem Processor (MASP) appears first.

```
BACKUP (FIXED) : MASP A - Backup starts on active MASP.
BACKUP (FIXED) : MASP A - Backup on active MASP to fixed disk
complete.
BACKUP (FIXED) : MASP A - Backup starts on standby MASP.
BACKUP (FIXED) : MASP A - Backup on standby MASP to fixed disk
complete.
```

Figure 2-45 Add a Concerned Signaling Point Code - Sheet 1 of 4

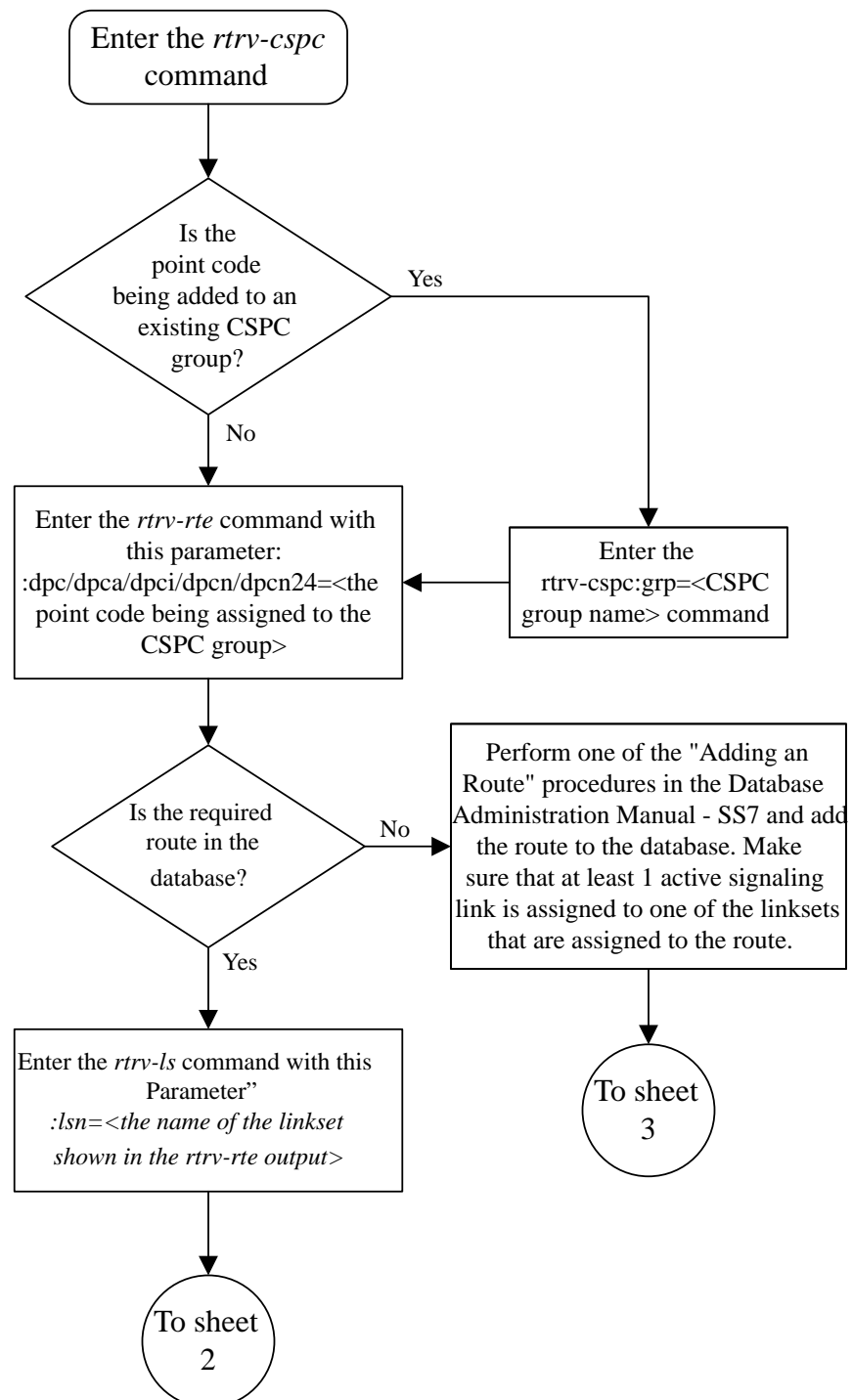

Figure 2-46 Add a Concerned Signaling Point Code - Sheet 2 of 4

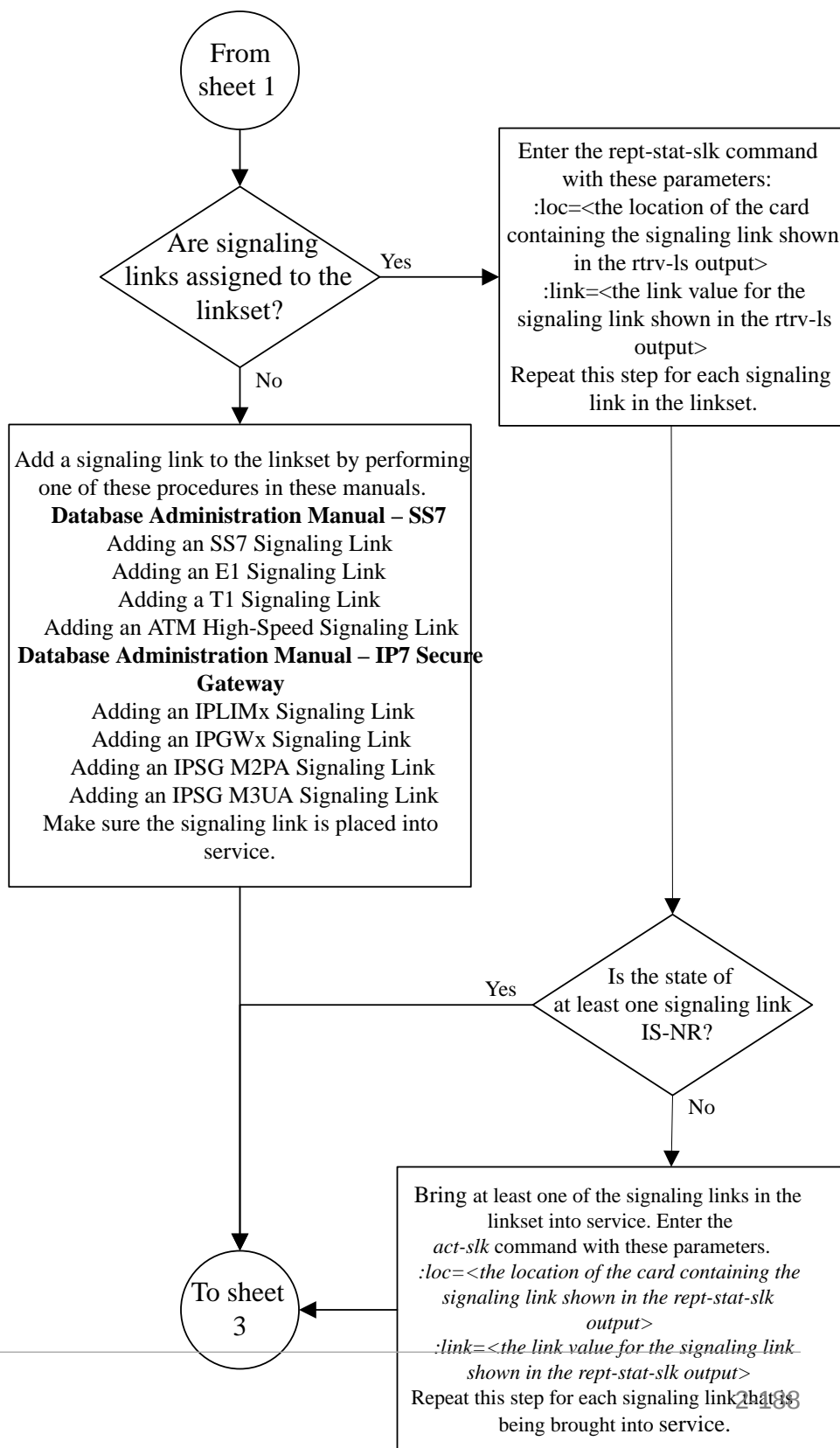

Figure 2-47 Add a Concerned Signaling Point Code - Sheet 3 of 4

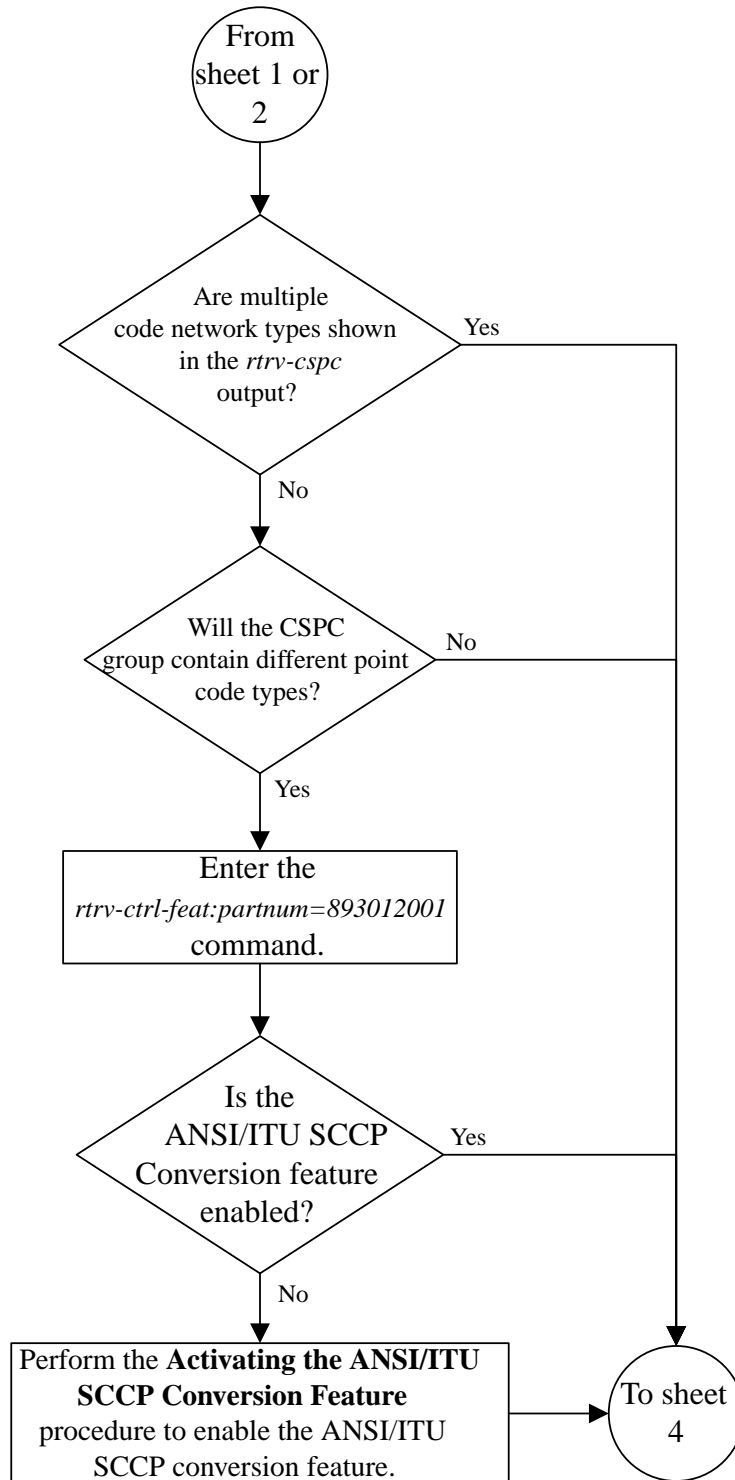
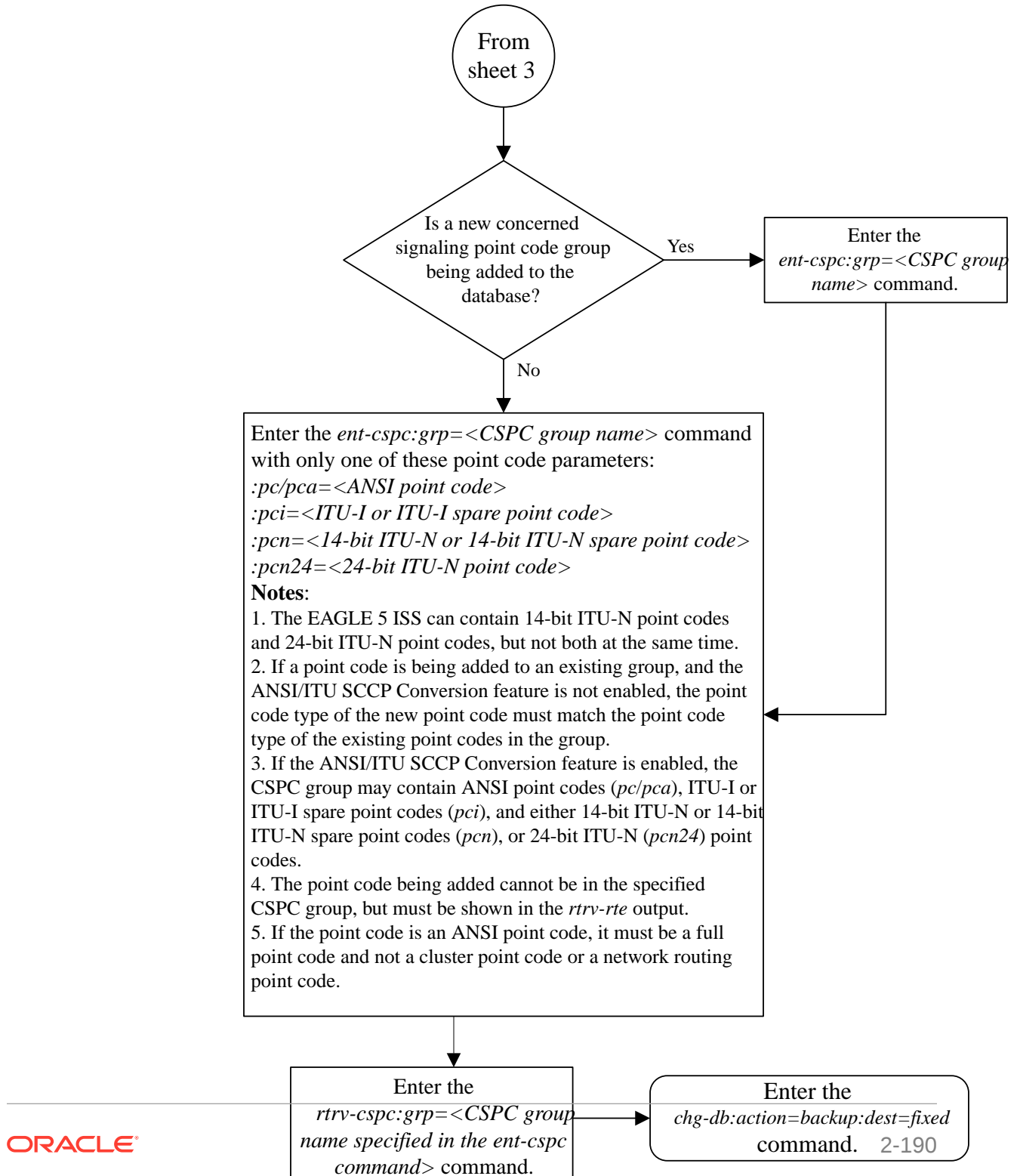

Figure 2-48 Add a Concerned Signaling Point Code - Sheet 4 of 4



Removing a Concerned Signaling Point Code

This procedure is used to remove a concerned signaling point code (CSPC) group from the database using the `dlt-cspc` command.

The `dlt-cspc` command uses these parameters.

`:grp` – The name of the concerned signaling point code group that contains the point codes that should be notified of the subsystem status.

`:pc/pca/pci/pcn/pcn24` – The point code of the signaling point that is to be in the concerned signaling point code group, either an ANSI point code (`pc/pca`), ITU-I or ITU-I spare point code (`pci`), a 14-bit ITU-N or 14-bit ITU-N spare point code (`pcn`), or a 24-bit ITU-N (`pcn24`) point code.

Note:

Refer to Chapter 2, *Configuring Destination Tables in Database Administration - SS7 User's Guide* for a definition of the point code types that are used on the EAGLE and for a definition of the different formats that can be used for ITU national point codes.

`:all` – Confirms that all entries for a particular concerned signaling point code group are to be removed.

The examples in this procedure are used to remove the concerned signaling point code 008-008-008 from the CSPC group `grp10` from the database.

The CSPC must be in the database for the indicated group.

1. Display the group names in the database using the `rtrv-cspc` command.

This is an example of the possible output.

```
rlghncxa03w 07-05-25 09:47:31 GMT EAGLE5 37.0.0
CSPC GRP NETWORK PERCENT FULL
grp01 ANSI 6%
grp02 ITU-I 9%
grp03 ITU-N 12%
grp04 ANSI 15%
grp05 ANSI 15%
grp10 ANSI 15%
grp15 ANSI 15%
```

If the ANSI/ITU SCCP Conversion feature is enabled, and multiple network point code types are assigned to CSPC groups, the `rtrv-cspc` output is displayed as follows in this example.

```
rlghncxa03w 07-05-25 09:57:31 GMT EAGLE5 37.0.0
CSPC GRP NETWORK PERCENT FULL
grp01 ANSI, ITU-I, ITU-N 9%
grp02 ITU-I 9%
grp03 ANSI, ITU-N 6%
```

```
grp04      ANSI      15%
grp05      ANSI      15%
grp10      ANSI      15%
grp15      ANSI      15%
```

2. Display the point codes in the CSPC group that you wish to remove from that CSPC group using the `rtrv-cspc` command with the CSPC group name.

For this example, enter this command.

```
rtrv-cspc:grp=grp10
```

This is an example of the possible output.

```
rlghncxa03w 07-05-25 09:48:31 GMT EAGLE5 37.0.0
CSPC GRP      PCA
grp10         008-008-008
              009-009-009
```

If the ANSI/ITU SCCP Conversion feature is enabled, then point codes of multiple network types can be displayed, if point codes of multiple network types are assigned to the CSPC group, as shown in this example.

```
rlghncxa03w 07-05-25 09:57:31 GMT EAGLE5 37.0.0
CSPC GRP      PC          TYPE
grp10         008-008-008    A
              009-009-009    A
              3-003-3      I
              00112        N
```

 **Note:**

If only a point code entry in the CSPC group is being removed, skip steps 3 and 4, and go to step 5.

3. Display the status of the Flexible GTT Load Sharing feature by entering the `rtrv-ctrl-feat` command with the Flexible GTTLoad Sharing feature part number.

Enter this command.

```
rtrv-ctrl-feat:partnum=893015401
```

The following is an example of the possible output.

```
rlghncxa03w 07-05-28 21:15:37 GMT EAGLE5 37.0.0
The following features have been permanently enabled:
```

Feature Name	Partnum	Status	Quantity
Flexible GTT Load Sharing	893015401	on	----

The following features have been temporarily enabled:

Feature Name	Partnum	Status	Quantity	Trial Period
Left				

Zero entries found.

The following features have expired temporary keys:

```
Feature Name          Partnum
Zero entries found.
```

If the Flexible GTT Load Sharing feature is not enabled, skip step 4 and go to step 5.

If the Flexible GTT Load Sharing feature is enabled, go to step 4.

4. Display the mated applications in the database using the `rtrv-map` command.

This is an example of the possible output.

```
rlghncxa03w 09-07-07 00:34:31 GMT EAGLE5 41.1.0
```

```
MAPSET ID=DFLT
```

```
PCA           Mate PCA           SSN RC MULT SRM MRC GRP NAME SSO
255-001-000           250 10 SOL *Y *Y grp01    ON
```

```
MAPSET ID=1
```

```
PCA           Mate PCA           SSN RC MULT SRM MRC GRP NAME SSO
255-001-000           251 10 SHR *Y *Y grp01    OFF
                253-001-002 254 10 SHR *Y *Y grp01    OFF
```

```
MAPSET ID=2
```

```
PCA           Mate PCA           SSN RC MULT SRM MRC GRP NAME SSO
255-001-000           252 10 SOL *Y *Y grp01    ON
```

```
MAPSET ID=DFLT
```

```
PCA           Mate PCA           SSN RC MULT SRM MRC GRP NAME SSO
255-001-000           253 10 SHR *Y *Y grp01    OFF
                253-001-004 254 10 SHR *Y *Y grp01    OFF
```

```
MAPSET ID=3
```

```
PCA           Mate PCA           SSN RC MULT SRM MRC GRP NAME SSO
255-001-001           255 10 DOM YES YES grp01    ON
                253-001-005 254 20 DOM YES YES grp01    ON
```

```
MAPSET ID=4
```

```
PCA           Mate PCA           SSN RC MULT SRM MRC GRP NAME SSO
255-001-001           250 10 DOM YES YES grp01    OFF
                253-001-001 254 20 DOM YES YES grp01    OFF
```

```
MAPSET ID=DFLT
```

```
PCA           Mate PCA           SSN RC MULT SRM MRC GRP NAME SSO
255-001-002           251 10 SHR *Y *Y grp01    OFF
                255-001-002 254 10 SHR *Y *Y grp01    OFF
```

```
MAPSET ID=5
```

```
PCA           Mate PCA           SSN RC MULT SRM MRC GRP NAME SSO
255-001-002           252 10 DOM YES YES grp01    ON
                255-001-003 254 20 DOM YES YES grp01    ON
```

```
MAPSET ID=6
```



```

PCA          Mate PCA      SSN RC MULT SRM MRC GRP NAME SSO
255-001-002          253 10 SHR *Y *Y grp01  ON
                   255-001-004 254 10 SHR *Y *Y grp01  ON

MAPSET ID=7
PCA          Mate PCA      SSN RC MULT SRM MRC GRP NAME SSO
002-002-007          50 10 COM YES *Y grp01  OFF
                   002-002-008 30 10 COM YES *Y grp01  OFF
                   002-002-009 30 10 COM YES *Y grp01  OFF
                   002-002-010 30 20 COM YES *Y grp01  OFF
                   002-002-011 30 20 COM YES *Y grp01  OFF

MAPSET ID=8
PCI          Mate PCI      SSN RC MULT SRM MRC GRP NAME SSO
2-001-2          255 10 DOM NO YES grp03  OFF
                   2-001-1          254 20 DOM NO YES grp03  OFF

MAPSET ID=9
PCN          Mate PCN      SSN RC MULT SRM MRC GRP NAME SSO
00347          253 10 SHR *N *N grp05  OFF
                   01387          254 10 SHR *N *N grp05  OFF

MAP TABLE IS (20 of 36000) 1 % FULL
  
```

If any of the following items are not shown in the `rtrv-map` output, then the feature corresponding to these items is not enabled, or turned on if required.

- The `MAPSET` field - the Flexible GTT Load Sharing feature is not enabled.
- The `MRNSET` and `MRNPC` fields - the GTT Load Sharing with Alternate Routing Indicator feature is not enabled.
- The `WT`, `%WT`, `THR` columns - the Weighted GTT Load Sharing feature is not enabled and turned on.

If the CSPC group being removed in this procedure is shown in the `rtrv-map` output, perform [Changing the Attributes of a Mated Application](#) to change the CSPC group assigned to the mated applications that are currently referencing the CSPC group being removed. After the CSPC group assignments have been changed, go to step 5.

If the CSPC group being removed in this procedure is not shown in the `rtrv-map` output, go to step 5.

5. Remove the concerned signaling point code from the database using the `dlt-cspc` command.

For this example, enter this command.

```
dlt-cspc:grp=grp10:pca=008-008-008
```

This message should appear.

```

rlghncxa03w 07-05-25 09:49:31 GMT EAGLE5 37.0.0
DLT-CSPC: MASP A - COMPLTD
  
```

 **Note:**

If you wish to remove the entire CSPC group, enter the `dlt-cspc` command with the CSPC group name and the `all=yes` parameter. For this example, enter the `dlt-cspc:grp=grp10:all=yes` command.

6. Verify the changes using the `rtrv-cspc` command with the CSPC group name.

For this example, enter this command.

```
rtrv-cspc:grp=grp10
```

This is an example of the possible output.

```
rlghncxa03w 07-05-25 09:50:31 GMT EAGLE5 37.0.0
CSPC GRP      PCA
grp10        009-009-009
```

 **Note:**

If the ANSI/ITU SCCP Conversion feature is enabled, then point codes of multiple network types can be displayed in the `rtrv-cspc` output, if point codes of multiple network types are assigned to the CSPC group.

7. Backup the new changes using the `chg-db:action=backup:dest=fixed` command.

These messages should appear, the active Maintenance and Administration Subsystem Processor (MASP) appears first.

```
BACKUP (FIXED) : MASP A - Backup starts on active MASP.
BACKUP (FIXED) : MASP A - Backup on active MASP to fixed disk
complete.
BACKUP (FIXED) : MASP A - Backup starts on standby MASP.
BACKUP (FIXED) : MASP A - Backup on standby MASP to fixed disk
complete.
```

Figure 2-49 Remove a Concerned Signaling Point Code - Sheet 1 of 3

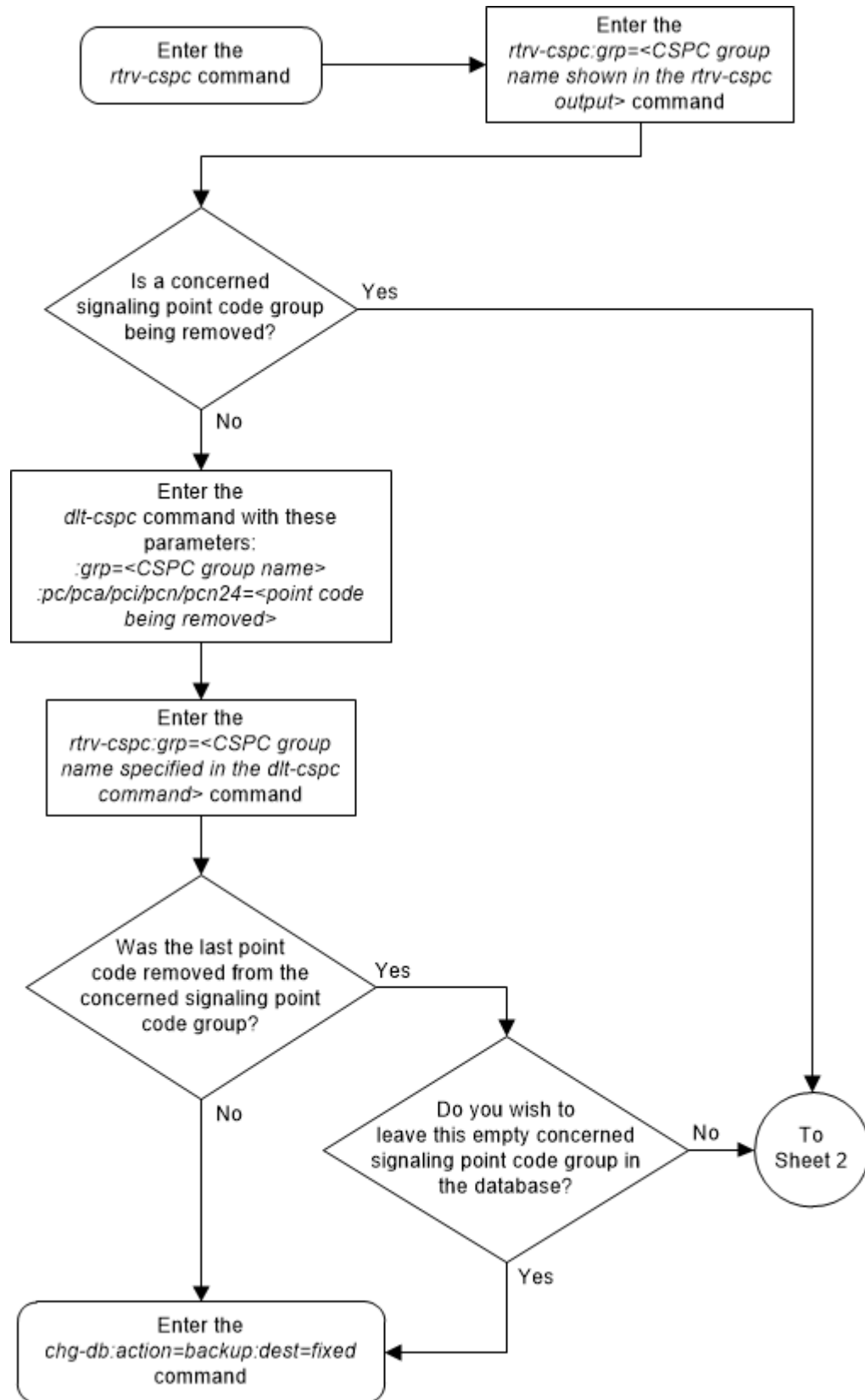

Figure 2-50 Remove a Concerned Signaling Point Code - Sheet 2 of 3

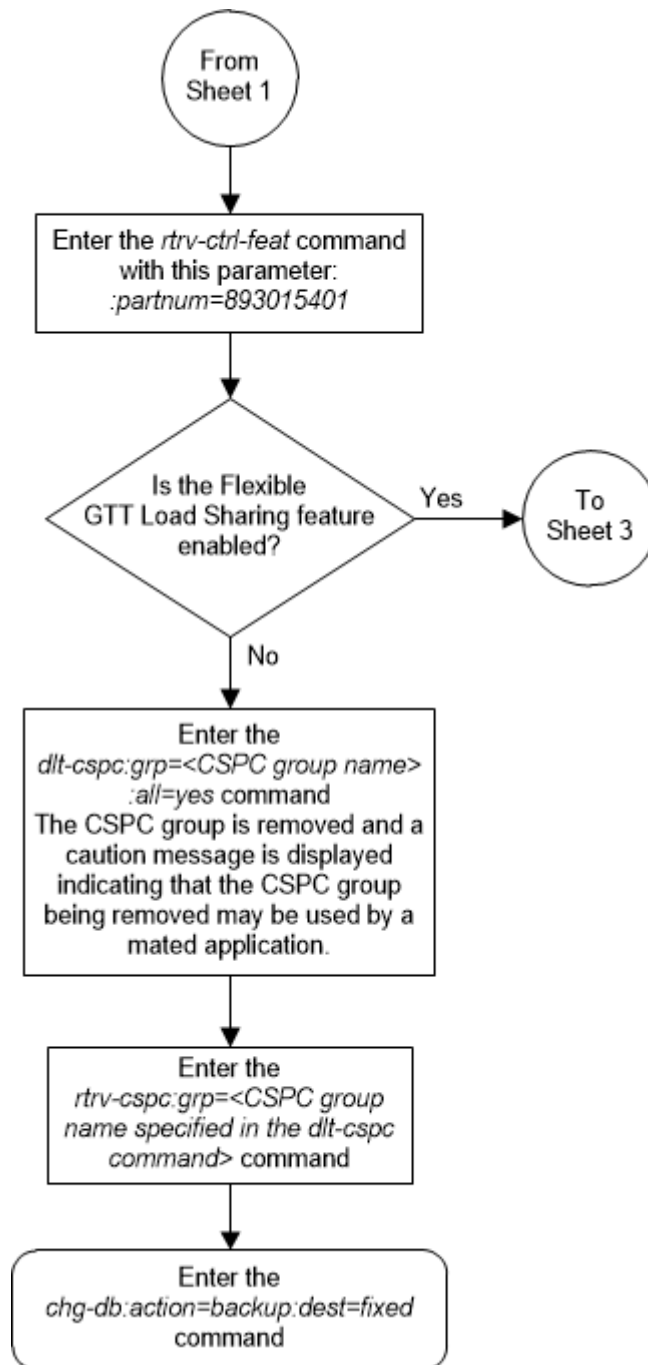
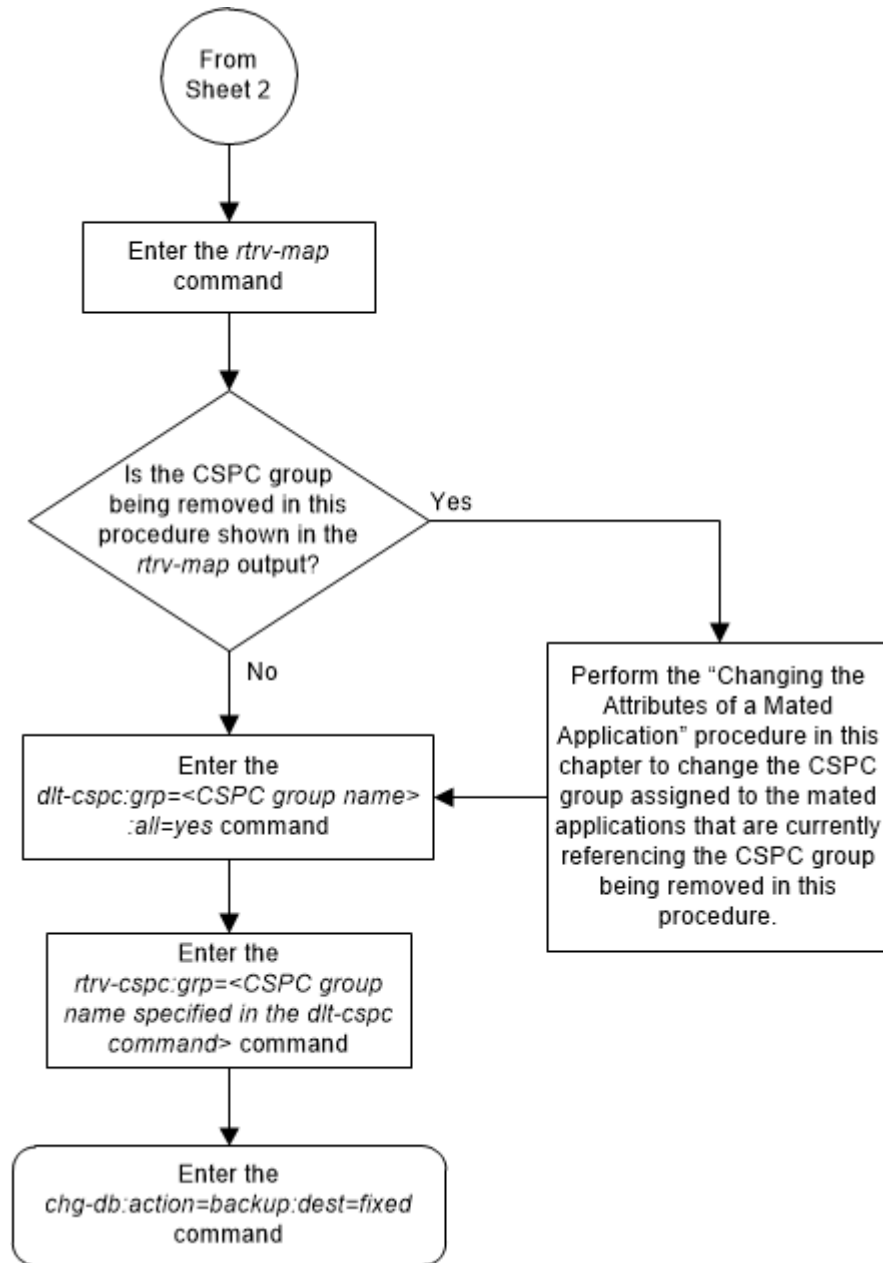

Figure 2-51 Remove a Concerned Signaling Point Code - Sheet 3 of 3



Provisioning a Solitary Mated Application

This procedure is used to provision a solitary mated application in the database using the `ent-map` command. A solitary mated application contains only one entry. The `ent-map` command use these parameters to provision a solitary mated application.

`:pc/pca/pci/pcn/pcn24` – The point code of the signaling point that is to receive the message.

 **Note:**

The point codes can be either an ANSI point code (*pc/pca*), ITU-I or ITU-I spare point code (*pci*), a 14-bit ITU-N or 14-bit ITU-N spare point code (*pcn*), or a 24-bit ITU-N (*pcn24*) point code.

 **Note:**

Refer to Chapter 2, Configuring Destination Tables in the *Database Administration - SS7 User's Guide* for a definition of the point code types that are used on the EAGLE and for a definition of the different formats that can be used for ITU national point codes.

:ssn – Subsystem number – the subsystem address of the point code that is to receive the message. The value for this parameter is 2 to 255.

:grp – The name of the concerned signaling point code (CSPC) group that contains the point codes that should be notified of the subsystem status. This parameter applies to both RPCs/SSNs. The value for this parameter is shown in the *rtrv-cspc* output. If the desired value is not shown in the *rtrv-cspc* output, perform the [Adding a Concerned Signaling Point Code](#) procedure to add the desired group. If this parameter is not specified, then a CSPC group name is not specified for the mated application.

:sso – Subsystem Status Option – defines whether the subsystem status option is on or off. This parameter allows the user the option to have the specified subsystem marked as prohibited even though an MTP-RESUME message has been received by the indicating that the specified point code is allowed. The *sso* parameter cannot be specified if the *pc/pca/pci/pcn/pcn24* value is the EAGLE's true point code, shown in the *rtrv-sid* output. The value for this parameter is *on* or *off*. The default value is *off*.

:mapset – The MAP set ID that the mated applications are assigned to. This parameter can be specified only if the Flexible GTT Load Sharing feature is enabled. This parameter must be specified if the Flexible GTT Load Sharing feature is enabled. If the Flexible GTT Load Sharing feature is enabled, the point code and subsystem specified for the global title translation must be assigned to the MAP set specified by this parameter. The status of the Flexible GTT Load Sharing feature is shown in the *rtrv-ctrl-feat* output. To enable the Flexible GTT Load Sharing feature, perform the [Activating the Flexible GTT Load Sharing Feature](#) procedure.

The *mapset* parameter has three values.

- *dflt* – to assign the MAP to the default MAP set.
- *new* – to assign the mated application to a new MAP set.
- The specific number of an existing MAP set if you are assigning the mated application to an existing MAP set. This value can be specified only with the *chg-map* command.

Refer to the [Provisioning a MAP Set](#) section for information on provisioning MAP sets.

:mrnset – The MRN set ID that is being assigned to the mated application. This is the MRN set from which alternate routing indicator searches are performed.

:mrnpc/mrnpca/mrnpai/mrnpai/mrnpai24 – The point code assigned to the mrnset that is being assigned to the MAP set.

The current values of the mrnset and :mrnpc/mrnpca/mrnpai/mrnpai/mrnpai24 parameters are shown in the rtrv-map output only if the Flexible GTT Load Sharing and the GTT Load Sharing with Alternate Routing Indicator features are enabled.

The new values for the mrnset and mrnpc/mrnpca/mrnpai/mrnpai/mrnpai24 parameters must be shown in the rtrv-mrn output.

The network type of the pc/pca/pai/pai/pai24 and mrnpc/mrnpca/mrnpai/mrnpai/mrnpai24 parameter values must be compatible, as shown in [Table 2-38](#).

Table 2-38 MAP and MRN Point Code Parameter Combinations

MAP Point Code Parameter	MRN Point Code Parameter
pc/pca	mrnpc/mrnpca
pai or pai (See Notes 1 and 2)	mrnpai or mrnpai (See Notes 1 and 2)
pai24	mrnpai24

 **Note:**

1. If the network type of the MAP point code parameter is ITU-I (pai), the network type of the MRN point code parameter can be either ITU-I (mappai) or ITU-N (mapnai).
2. If the network type of the MAP point code parameter is ITU-N (pai), the network type of the MRN point code parameter can be either ITU-I (mappai) or ITU-N (mapnai).

:mrc – Message routing under congestion – specifies whether Class 0 messages are routed during congestion conditions. The values for this parameter are yes and no. This parameter can be specified for any type of mated application, but this parameter affects only the traffic for a dominant mated application. The default value for ANSI, ITU-I, and ITU-N solitary mated applications is yes. The default value for ITU-N24 solitary mated applications is no.

:srm – Subsystem routing messages – defines whether subsystem routing messages (SBR, SNR) are transmitted between the mated applications. The values for this parameter are yes and no. The srm=yes parameter can be specified only for ANSI mated applications. This parameter affects traffic only on dominant and combined dominant/load shared mated applications. The default value for ANSI solitary mated applications is yes. The default value for ITU solitary mated applications is no.

The ent-map command also contains other parameters that can be used to provision mated applications, but cannot be used to provision a solitary mated applications. These parameters are: mpc/mpca/mpai/mpai/mpai24, mssn, rc, materc. If you wish to use these parameters to provision mated applications, perform one of these procedures.

- [Provisioning a Dominant Mated Application](#)

- [Provisioning a Load Shared Mated Application](#)
- [Provisioning a Combined Dominant/Load Shared Mated Application](#)

The `rc` parameter can be specified for a solitary mated application, but since a solitary mated application contains only one entry, the `rc` parameter does not need to be specified. If the `rc` parameter is not specified, the `rc` value is set to 10.

If the Weighted GTT Load Sharing feature is enabled, shown by the columns `WT`, `%WT`, and `THR` in the `rtrv-map` output, the parameters `wt`, `mwt`, and `thr` cannot be specified for a solitary mated application. If you wish to use these parameters to provision a mated application, perform one of these procedures:

- [Provisioning a Load Shared Mated Application](#)
- [Provisioning a Combined Dominant/Load Shared Mated Application](#)

If the Flexible GTT Load Sharing feature is not enabled, the point code and subsystem number combination can be in the database only once. If the Flexible GTT Load Sharing feature is enabled, the point code and subsystem number combination can be in multiple MAP sets, but can be in the default MAP set only once. Refer to the [Provisioning a MAP Set](#) section for information on provisioning MAP sets.

The point codes specified in the `ent-map` command (`pc/pca`, `pci`, `pcn`, or `pcn24`) must be either a full point code in the routing point code table or the EAGLE's true point code. Cluster point codes or network routing point codes cannot be specified with this command. The `rtrv-rte` command can be used to verify the point codes in the routing table. The point codes in the routing table are shown in the `DPCA`, `DPCI`, `DPCN`, or `DPCN24` fields of the `rtrv-rte` command output. The EAGLE's true point code is shown in the `PCA`, `PCI`, `PCN`, or `PCN24` fields of the `rtrv-sid` command output.

A solitary mated application can be provisioned with a point code that is assigned to other mated applications as long as the SSN is not assigned to other mated applications. A point code can be assigned to maximum of 12 different SSNs.

If the EAGLE's true point code is specified in the mated application and the Flexible GTT Load Sharing feature is enabled, the mated application containing the EAGLE's true point code can be assigned only to the default MAP set.

A mated application containing the LNP subsystem can contain only the EAGLE's ANSI true point code. The LNP feature must be enabled for a quantity greater than zero.

A mated application containing the INP subsystem can contain only the EAGLE's true 14-bit ITU-N point code, 14-bit ITU-N spare point code, or 24-bit ITU-N point code. The INP or ANSI-41 INP Query feature must be enabled and turned on. The EAGLE can contain either 14-bit ITU-N point codes (spare or non-spare point codes) or 24-bit ITU-N point codes. Both types of point codes cannot be present on the EAGLE at the same time.

A mated application containing the EIR subsystem can contain only the EAGLE's true ITU-I point code, ITU-I spare point code, 14-bit ITU-N point code, 14-bit ITU-N spare point code, or 24-bit ITU-N point code. The EIR feature must be enabled and turned on. The EAGLE can contain either 14-bit ITU-N point codes (spare or non-spare point codes) or 24-bit ITU-N point codes. Both types of point codes cannot be present on the EAGLE at the same time.

A mated application containing the VFLEX subsystem can contain any of the EAGLE's true point codes. The V-Flex feature must be enabled and turned on. The EAGLE can contain either 14-bit ITU-N point codes (spare or non-spare point codes) or 24-bit

ITU-N point codes. Both types of point codes cannot be present on the EAGLE at the same time.

A mated application containing the ATINPQ subsystem can contain only the EAGLE's true ANSI point code, ITU-I point code, ITU-I spare point code, 14-bit ITU-N point code, or 14-bit ITU-N spare point code. The ATINP feature must be enabled.

A mated application containing the AIQ subsystem can contain any of the EAGLE's true point codes. The ANSI41 AIQ feature must be enabled. The EAGLE can contain either 14-bit ITU-N point codes (spare or non-spare point codes) or 24-bit ITU-N point codes. Both types of point codes cannot be present on the EAGLE at the same time.

The EAGLE can contain multiple entries that contain the EAGLE's true point code, shown in the `rtrv-sid` output. [Table 2-39](#) shows the numbers of entries that can be provisioned based on the type of point code.

Table 2-39 Maximum Number of True Point Code Entries

True Point Code Type	Maximum Number of Entries
ANSI	<p>1 - for the LNP subsystem</p> <p>2 - one entry for the LNP subsystem and one entry for the AIQ subsystem</p> <p>3 - one entry for the ATINPQ subsystem, one entry for the V-FLEX subsystem, and one entry for the AIQ subsystem</p> <p>The LNP subsystem cannot be used if the ATINPQ, EIR, INP, and V-FLEX subsystems are used.</p>
ITU-I	<p>4 - one entry for the ATINPQ subsystem, one entry for the EIR subsystem, one entry for the V-FLEX subsystem, and one entry for the AIQ subsystem</p>
ITU-N	<p>5 - one entry for the ATINPQ subsystem, one entry for the EIR subsystem, one entry for the INP subsystem, one entry for the V-FLEX subsystem, and one entry for the AIQ subsystem</p>

The format of the point codes in the CSPC group specified with the `grp` parameter must be the same as the point code specified with the `ent-map` command only if the ANSI/ITU SCCP Conversion feature is not enabled. If the ANSI/ITU SCCP Conversion feature is enabled, the CSPC group may contain a mixture of point code types (refer to the [Adding a Concerned Signaling Point Code](#) procedure), and the network type of the CSPC group can be different from the network type of the primary point code of the mated application. The status of the ANSI/ITU SCCP Conversion feature can be verified with the `rtrv-ctrl-feat` command.

If the `grp` and `ssn` parameter values are specified, and the specified point code and SSN is assigned to multiple mated applications, the `grp` and `ssn` values for all mated applications containing the specified point code and SSN will be changed to the values specified in this procedure.

The values of the `ssn` parameter must be from 2 to 255.

The EAGLE can contain 1024, 2000, or 3000 mated applications. The EAGLE default is 1024 mated applications. This quantity can be increased to 2000 by enabling

the feature access key for part number 893-0077-01, or to 3000 by enabling the feature access key for part number 893-0077-10. For more information on enabling these feature access keys, refer to the [Enabling the XMAP Table Expansion Feature](#) procedure.

Provisioning a MAP Set

The Flexible GTT Load Sharing feature provides the ability to define multiple load sharing sets in the MAP table where the same point code and subsystem can be assigned to different load sharing sets.

The MAP table contains specific load sharing sets, designated by numbers, and a default MAP set.

Flexible Final GTT Load Sharing provides flexible load sharing for global title translations defined in the GTT table and not for the MPS-based features. The MPS-based features do not support the MAP set ID parameter. The MPS-based features perform lookups for load sharing in the default MAP set and the GTT table. The entries in the GTT table can be linked to a MAP set ID, allowing lookups in a specific MAP set other than the default MAP set.

Any MAP entries that were provisioned in the database before the Flexible GTT Load Sharing feature is enabled are placed in the default MAP set when the Flexible GTT Load Sharing feature is enabled.

To provision entries in the default MAP set, the `mapset=df1t` parameter must be specified with the `ent-map` command.

To provision entries in a new MAP set, the `mapset=new` parameter must be specified with the `ent-map` command. The `mapset=new` parameter can be specified only with the `ent-map` command. When the `ent-map` command is executed with the `mapset=new` parameter, the new MAP set ID is automatically generated and displayed in the output of the `ent-map` command as follows.

```
New MAPSET Created : MAPSETID = <new MAP set ID>
```

The default MAP set can contain multiple MAP groups. The point code and subsystem number combination can appear only once in the default MAP set. The point code can appear in multiple MAP groups in the default MAP set with different subsystem numbers.

The point code and subsystem number combination provisioned in a MAP set can be provisioned in multiple MAP sets. All the point code and subsystem number combinations in a MAP set must be different.

Canceling the `RTRV-MAP` Command

Because the `rtrv-map` command used in this procedure can output information for a long period of time, the `rtrv-map` command can be canceled and the output to the terminal stopped. There are three ways that the `rtrv-map` command can be canceled.

- Press the `F9` function key on the keyboard at the terminal where the `rtrv-map` command was entered.
- Enter the `canc-cmd` without the `trm` parameter at the terminal where the `rtrv-map` command was entered.

- Enter the `canc-cmd:trm=<xx>`, where `<xx>` is the terminal where the `rtrv-map` command was entered, from another terminal other than the terminal where the `rtrv-map` command was entered. To enter the `canc-cmd:trm=<xx>` command, the terminal must allow Security Administration commands to be entered from it and the user must be allowed to enter Security Administration commands. The terminal's permissions can be verified with the `rtrv-secu-trm` command. The user's permissions can be verified with the `rtrv-user` or `rtrv-secu-user` commands.

For more information about the `canc-cmd` command, refer to *Commands User's Guide*.

1. Display the mated applications in the database using the `rtrv-map` command.

This is an example of the possible output.

```
rlghncxa03w 09-07-07 00:34:31 GMT EAGLE5 41.1.0
```

```
MAPSET ID=DFLT
PCA      Mate PCA      SSN RC MULT SRM MRC GRP NAME SSO
255-001-000      250 10 SOL *Y *Y grp01 ON
```

```
MAPSET ID=1
PCA      Mate PCA      SSN RC MULT SRM MRC GRP NAME SSO
255-001-000      251 10 SHR *Y *Y grp01 OFF
                253-001-002 254 10 SHR *Y *Y grp01 OFF
```

```
MAPSET ID=2
PCA      Mate PCA      SSN RC MULT SRM MRC GRP NAME SSO
255-001-000      252 10 SOL *Y *Y grp01 ON
```

```
MAPSET ID=DFLT
PCA      Mate PCA      SSN RC MULT SRM MRC GRP NAME SSO
255-001-000      253 10 SHR *Y *Y grp01 OFF
                253-001-004 254 10 SHR *Y *Y grp01 OFF
```

```
MAPSET ID=3
PCA      Mate PCA      SSN RC MULT SRM MRC GRP NAME SSO
255-001-001      255 10 DOM YES YES grp01 ON
                253-001-005 254 20 DOM YES YES grp01 ON
```

```
MAPSET ID=4
PCA      Mate PCA      SSN RC MULT SRM MRC GRP NAME SSO
255-001-001      250 10 DOM YES YES grp01 OFF
                253-001-001 254 20 DOM YES YES grp01 OFF
```

```
MAPSET ID=DFLT
PCA      Mate PCA      SSN RC MULT SRM MRC GRP NAME SSO
255-001-002      251 10 SHR *Y *Y grp01 OFF
                255-001-002 254 10 SHR *Y *Y grp01 OFF
```

```
MAPSET ID=5
PCA      Mate PCA      SSN RC MULT SRM MRC GRP NAME SSO
255-001-002      252 10 DOM YES YES grp01 ON
                255-001-003 254 20 DOM YES YES grp01 ON
```

```

MAPSET ID=6
PCA           Mate PCA           SSN RC MULT SRM MRC GRP NAME SSO
255-001-002   255-001-004  253 10  SHR *Y  *Y  grp01  ON
                255-001-004  254 10  SHR *Y  *Y  grp01  ON

MAPSET ID=7
PCA           Mate PCA           SSN RC MULT SRM MRC GRP NAME SSO
002-002-007   002-002-008  50 10  COM YES *Y  grp01  OFF
                002-002-009  30 10  COM YES *Y  grp01  OFF
                002-002-010  30 20  COM YES *Y  grp01  OFF
                002-002-011  30 20  COM YES *Y  grp01  OFF

MAPSET ID=8
PCI           Mate PCI           SSN RC MULT SRM MRC GRP NAME SSO
2-001-2       2-001-1       255 10  DOM NO  YES  grp03  OFF
                2-001-1       254 20  DOM NO  YES  grp03  OFF

MAPSET ID=9
PCN           Mate PCN           SSN RC MULT SRM MRC GRP NAME SSO
00347        01387         253 10  SHR *N  *N  grp05  OFF
                01387         254 10  SHR *N  *N  grp05  OFF

```

MAP TABLE IS (25 of 36000) 1 % FULL

If any of the following items are not shown in the `rtrv-map` output, then the feature corresponding to these items is not enabled, or turned on if required.

- The MAPSET field - the Flexible GTT Load Sharing feature is not enabled.
- The MRNSET and MRNPC fields - the GTT Load Sharing with Alternate Routing Indicator feature is not enabled.
- The WT, %WT, THR columns - the Weighted GTT Load Sharing feature is not enabled and turned on.

Continue the procedure by performing one of these steps.

- If the maximum number of mated applications is 3000 and the current number of mated applications provisioned in the database is 3000, no mated applications with a new point code can be added. Continue the procedure with [3](#).
- If the `rtrv-map` output in shows that the maximum number of mated applications is either 1024 or 2000, and the mated application being added increases the number beyond 1024 or 2000, perform the [Enabling the XMAP Table Expansion Feature](#) procedure to increase the maximum number of mated applications that can be in the database. After the [Enabling the XMAP Table Expansion Feature](#) procedure has been completed, continue the procedure with [3](#). If the maximum number of mated applications is not increased, no new point codes can be used to provision mated applications.
- If the `rtrv-map` output in shows that the maximum number of mated applications is either 1024, 2000, or 3000 and the mated application being added will not increase the number beyond the quantity shown in the `rtrv-map` output in, continue the procedure with [3](#).

- If the maximum number of mated applications is 36,000, continue the procedure with [2](#).
2. To verify the number of different point codes that can be provisioned for mated applications, enter the `rtrv-tbl-capacity` command.

If the maximum number of mated applications shown in the `rtrv-map` output in [1](#) is 36000, the Flexible GTT Load Sharing feature is enabled.

 **Note:**

The `rtrv-tbl-capacity` command output contains other fields that are not used by this procedure. If you wish to see all the fields displayed by the `rtrv-tbl-capacity` command, see the `rtrv-tbl-capacity` command description in *Commands User's Guide*.

Although the `rtrv-map` output shows there can be 36000 entries, a maximum of 1024, 2000, or 3000 different point codes (depending on whether the XMAP Table Expansion feature is enabled for 2000 or 3000 mated applications) can be provisioned for mated applications.

The following is an example of the possible output.

```
rlghncxa03w 07-05-28 21:15:37 GMT EAGLE5 37.0.0  
  
MAP table is (3000 of 3000) 100% full
```

Continue the procedure by performing one of these steps.

- If the maximum number of mated applications shown in this step is 3000 and the current number of mated applications provisioned in the database is 3000, no mated applications with a new point code can be added. Continue the procedure with [3](#).
 - If the maximum number of mated applications is either 1024 or 2000, and the mated application being added increases the number beyond 1024 or 2000, perform the [Enabling the XMAP Table Expansion Feature](#) procedure to increase the maximum number of mated applications that can be in the database. After the [Enabling the XMAP Table Expansion Feature](#) procedure has been completed, continue the procedure with [3](#). If the maximum number of mated applications is not increased, no new point codes can be used to provision mated applications.
 - If the maximum number of mated applications is either 1024, 2000, or 3000 and the mated application being added will not increase the number beyond the quantity shown in the `rtrv-map` output in, continue the procedure with [3](#).
3. A mated application can be provisioned with a point code that is assigned to other mated applications as long as the SSN is not assigned to other mated applications. A point code can be assigned to maximum of 12 different SSNs.

Verify the number of SSNs assigned to the point code that will be specified for the mated application in this procedure by entering the `rtrv-map` command with the point code of the new mated application. For this example, enter this command.

```
rtrv-map:pca=255-001-000
```

This is an example of the possible output.

PCA	Mate PCA	SSN	RC	MULT	SRM	MRC	GRP	NAME	SSO
255-001-000		250	10	SOL	*Y	*Y	grp01		ON
255-001-000		251	10	SHR	*Y	*Y	grp01		OFF
	253-001-002	254	10	SHR	*Y	*Y	grp01		OFF
255-001-000		252	10	SOL	*Y	*Y	grp01		ON
255-001-000		253	10	SHR	*Y	*Y	grp01		OFF
	253-001-004	254	10	SHR	*Y	*Y	grp01		OFF

If the Flexible GTT Load Sharing feature is enabled, the MAPSET IDs for the mated applications are shown in the `rtrv-map` output.

If the Weighted GTT Load Sharing feature is enabled and turned, the `WT`, `%WT`, and `THR` columns are shown in the `rtrv-map` output.

If the point code is assigned to less than 12 different SSNs, then the existing point code in the `rtrv-map` output can be used to provision the mated application. Continue the procedure with 4.

If the point code is assigned to 12 different SSNs, another existing point code in the `rtrv-map` output or a new point code must be used to provision the mated application. If an existing point code in the `rtrv-map` output will be used to provision the mated application, repeat this step for that point code. Then continue the procedure with 4.

If a new point code will be used to provision the mated application, continue the procedure with 4.

If the point code is assigned to 12 different SSNs, and neither an existing point code in the `rtrv-map` output nor a new point code will be used to provision the mated application, then this procedure cannot be performed.

 **Note:**

If a concerned signaling point code (CSPC) group is not being assigned to the mated application, continue the procedure with 6.

4. Display the point codes in the CSPC group that you wish to assign to the mated application by first entering the `rtrv-cspc` command with no parameters.

This is an example of the possible output.

```
rlghncxa03w 07-05-25 09:48:31 GMT EAGLE5 37.0.0
CSPC GRP NETWORK PERCENT FULL
grp01 ANSI 6%
grp02 ITU-I 9%
grp03 ITU-N 12%
grp04 ANSI 15%
grp05 ANSI 15%
grp10 ANSI 15%
grp15 ANSI 15%
```

If the desired CSPC group is shown in the `rtrv-cspc` output, re-enter the `rtrv-cspc` command with the CSPC group name. For this example, enter these commands.

```
rtrv-cspc:grp=grp05
```

This is an example of the possible output.

```
rlghncxa03w 07-05-25 09:48:31 GMT EAGLE5 37.0.0
CSPC GRP      PCA
grp05         005-005-005
              007-007-007
              008-008-008
              009-009-009
```

```
rtrv-cspc:grp=grp10
```

This is an example of the possible output.

```
rlghncxa03w 07-05-25 09:59:31 GMT EAGLE5 37.0.0
CSPC GRP      PCA
grp10         003-003-003
              004-004-004
              008-008-008
              009-009-009
```

```
rtrv-cspc:grp=grp15
```

This is an example of the possible output.

```
rlghncxa03w 07-05-25 09:48:31 GMT EAGLE5 37.0.0
CSPC GRP      PCA
grp15         005-005-005
              006-006-006
              008-008-008
              009-009-009
```

 **Note:**

If the ANSI/ITU SCCP Conversion feature is enabled, then point codes of multiple network types can be displayed in the `rtrv-cspc` output, if point codes of multiple network types are assigned to the CSPC group.

If the CSPC group is not in the database, or if the required point code is not assigned to the CSPC group, perform the [Adding a Concerned Signaling Point Code](#) procedure to add the required CSPC group or point code to the database.

 **Note:**

If the output of the `rtrv-cspc` command performed in 4 shows CSPC groups containing a mixture of point code types, or if the new CSPC group that was added in 4 contains a mixture of point code types, continue the procedure with 6.

5. The format of the point codes in the CSPC group specified with the `grp` parameter must be the same as the primary point code specified with the `ent-map` command unless if the ANSI/ITU SCCP Conversion feature is not enabled.

If the ANSI/ITU SCCP Conversion feature is enabled, the CSPC group may contain a mixture of point code types (refer to the [Adding a Concerned Signaling Point Code](#) procedure), and the network type of the CSPC group can be different from the network type of the primary point code of the mated application.

Verify the status of the ANSI/ITU SCCP Conversion feature by entering this command.

```
rtrv-ctrl-feat:partnum=893012001
```

The following is an example of the possible output.

```
rlghncxa03w 07-05-28 21:15:37 GMT EAGLE5 37.0.0
```

The following features have been permanently enabled:

Feature Name	Partnum	Status	Quantity
SCCP Conversion	893012001	on	----

The following features have been temporarily enabled:

Feature Name	Partnum	Status	Quantity	Trial
Period Left				
Zero entries found.				

The following features have expired temporary keys:

Feature Name	Partnum
Zero entries found.	

If the ANSI/ITU SCCP Conversion feature is not enabled, perform the [Activating the ANSI/ITU SCCP Conversion Feature](#) procedure to enable the ANSI/ITU SCCP Conversion feature.

6. If the `MAPSET` column is shown in the `rtrv-map` output in 1, the Flexible GTT Load Sharing feature is enabled. Continue the procedure with 7.

If the `MAPSET` column is not shown in 1 and you do not wish to provision MAP sets in this procedure, continue the procedure with 7.

If the `MAPSET` column is not shown in 1 and you wish to provision MAP sets in this procedure, perform the [Activating the Flexible GTT Load Sharing Feature](#) procedure to enable the Flexible GTT Load Sharing feature. After the Flexible GTT Load Sharing feature is enabled, continue the procedure with 7.

 **Note:**

If the EAGLE's point code and subsystem number are being assigned to the mated application, continue the procedure with 11.

7. Display the destination point codes in the database by entering the `rtrv-dstn` command. This is an example of the possible output.

```
rlghncxa03w 10-12-10 11:43:04 GMT EAGLE5 43.0.0
Extended Processing Time may be Required
```

DPCA	CLLI	BEI	ELEI	ALIASI
ALIASN/N24	DMN			
001-207-000	-----	no	---	-----
-----	SS7			
001-001-001	-----	no	---	-----
-----	SS7			
001-001-002	-----	no	---	-----
-----	SS7			
001-005-000	-----	no	---	-----
-----	SS7			
001-007-000	-----	no	---	-----
-----	SS7			
008-012-003	-----	no	---	-----
-----	SS7			
003-002-004	-----	no	---	-----
-----	SS7			
009-002-003	-----	no	---	-----
-----	SS7			
010-020-005	-----	no	---	-----
-----	SS7			

DPCI	CLLI	BEI	ELEI	ALIASA
ALIASN/N24	DMN			
1-207-0	-----	no	---	-----
-----	SS7			
0-015-0	-----	no	---	-----
-----	SS7			
0-017-0	-----	no	---	-----
-----	SS7			
1-011-1	-----	no	---	-----
-----	SS7			
1-011-2	-----	no	---	-----
-----	SS7			

```
Destination table is (14 of 2000) 1% full
Alias table is (0 of 12000) 0% full
PPC table is (1 of 20) 5% full
```

If the required point code is not shown in the `rtrv-dstn` output, perform the "Adding a Destination Point Code" procedure in *Database Administration - SS7*

User's Guide to add the required point code. A proxy point code cannot be assigned to the point code.

After the new point code has been added, skip 8 through 10 and perform one of the Adding a Route procedures in *Database Administration - SS7 User's Guide* and add the required route to the database. After the route has been added, continue the procedure with 14.

8. Display the point code that will be assigned to the mated application by using the `rtrv-dstn` command and specifying the point code. For this example, enter this command.

```
rtrv-dstn:dpca=010-020-005
```

This is an example of the possible output.

```
rlghncxa03w 10-12-10 11:43:04 GMT EAGLE5 43.0.0
```

DPCA	CLLI	BEI	ELEI	ALIASI
ALIASN/N24	DMN			
010-020-005	-----	no	---	-----
-----	SS7			

PPCA	NCAI	PRX	RCAUSE	NPRST	SPLITIAM	HMSMSC	HMSCP
SCCPMSGCNV							
009-002-003	----	no	50	on	20	no	no none

```
Destination table is (14 of 2000) 1% full
```

```
Alias table is (0 of 12000) 0% full
```

```
PPC table is (1 of 20) 5% full
```

If the adjacent point code is not shown in the `rtrv-dstn` command output, the following output is displayed.

```
rlghncxa03w 09-05-10 11:43:04 GMT EAGLE5 41.0.0
```

```
No destinations meeting the requested criteria were found
```

```
Destination table is (14 of 2000) 1% full
```

```
Alias table is (0 of 12000) 0% full
```

```
PPC table is (1 of 20) 5% full
```

A proxy point code (a point code value is shown in the PPC column) cannot be assigned to the point code. If a proxy point code is shown in this step, choose another point code from the `rtrv-dstn` output in the previous step and repeat this step.

After the new point code has been added, skip 9 through 10 and perform one of the Adding a Route procedures in *Database Administration - SS7 User's Guide* and add the required route to the database. After the route has been added, continue the procedure with 14.

9. Enter the `rtrv-rte` command with the `dpc` parameter specifying the point code to be used with the `ent-map` command to verify whether or not the point code is the DPC of a route.

For this example, enter these commands.

```
rtrv-rte:dPCA=006-006-006
```

This is an example of the possible output.

```
rlghncxa03w 07-05-07 11:43:04 GMT EAGLE5 37.0.0
  DPCA          ALIASI      ALIASN/N24    LSN          RC      APCA
  006-006-006  -----  -----      ls06         10
006-006-006
                                           RTX:No  CLLI=ls06clli
```

```
rtrv-rte:dPCA=007-007-007
```

This is an example of the possible output.

```
rlghncxa03w 07-05-07 11:43:04 GMT EAGLE5 37.0.0
  DPCA          ALIASI      ALIASN/N24    LSN          RC      APCA
  007-007-007  -----  -----      ls03         10
007-007-007
                                           ls02         30
150-150-150
                                           lsa2         50
200-200-200
                                           lsa5         50
066-030-100
                                           RTX:No  CLLI=ls03clli
```

If the point code is not shown in the `rtrv-rte` output, perform one of the Adding a Route procedures in *Database Administration - SS7 User's Guide* and add the required route to the database. After this step is performed, continue the procedure with by performing one of these steps.

- If the `mrnset` and MRN point code parameters will not be specified for the mated application, continue the procedure with [14](#).
- If the `mrnset` and MRN point code parameters will not be specified for the mated application, continue the procedure by performing one of these steps.
 - If the `MRNSET` and `MRNPC` fields are shown in the `rtrv-map` output in [1](#), continue the procedure with [10](#).
 - If the `MRNSET` and `MRNPC` fields are not shown in the `rtrv-map` output in [1](#), the GTT Load Sharing with Alternate Routing Indicator feature is not enabled. Perform the [Activating the GTT Load Sharing with Alternate Routing Indicator Feature](#) procedure to enable the GTT Load Sharing with Alternate Routing Indicator feature. After the [Activating the GTT Load Sharing with Alternate Routing Indicator Feature](#) procedure has been performed, continue the procedure with [10](#).

- 10.** The MRN point code value must be assigned to an MRN set. The MRN set must be shown in the `rtrv-mrn` output. Display the MRN sets by entering the `rtrv-mrn` command. This is an example of the possible output.

```
rlghncxa03w 09-02-07 00:34:31 GMT EAGLE5 40.1.0
  MRNSET MAPSET  MAPPC          MAPSSN      PC          RC WT
%WT THR
  DFLT   7      002-002-007      50         005-005-005  10 10
```

```

14 1
14 1
28 1
42 1
23 1
23 1
23 1
23 1
29 1

```

```

MRNSET MAPSET MAPPC MAPSSN PC RC WT
%WT THR
1 -----
14 1
14 1
28 1
42 1
23 1
23 1
23 1
23 1
29 1

```

MRN table is (16 of 5990) 1% full

If any of the following items are not shown in the `rtrv-mrn` output, then the feature corresponding to these items is not enabled, or turned on if required.

- The `MRNSET` field - the Flexible GTT Load Sharing feature is not enabled.
- The `MAPSET`, `MAPPC` and `MAPSSN` fields - the GTT Load Sharing with Alternate Routing Indicator feature is not enabled.
- The `WT`, `%WT`, `THR` columns - the Weighted GTT Load Sharing feature is not enabled and turned on.

If the MRN set that you wish to use, containing the desired point code, is shown in the `rtrv-mrn` output, continue the procedure with [14](#).

 **Note:**

The network type of the `pc/pca/pci/pcn/pcn24` and `mrnpc/mrnpca/mrnpai/mrnpai24` parameter values must be compatible, as shown in [Provisioning a Solitary Mated Application](#).

If the MRN set that you wish to use is not shown in the `rtrv-mrn` output, add the required MRN set by performing the [Provisioning MRN Entries](#) procedure.

After the MRN set has been added, continue the procedure with [14](#).

11. Display the EAGLE self-identification, using the `rtrv-sid` command.

The EAGLE's true point code is shown in either the PCA, PCI, PCN, or PCN24 fields. This is an example of the possible output.

```

rlghncxa03w 07-05-10 11:43:04 GMT EAGLE5 37.0.0
  PCA          PCI          PCN
CLLI          PCTYPE
  010-020-030  1-023-1      12-0-14-1
rlghncxa03w  OTHER
  s-1-023-1    s-12-0-14-1

  CPCA
001-001-001    002-002-003    002-002-004    002-002-005
002-002-006    002-002-007    002-002-008    002-002-009
004-002-001    004-003-003    050-060-070

  CPCI
1-001-1        1-001-2        1-001-3        1-001-4
1-002-1        1-002-2        1-002-3        1-002-4
2-001-1        7-222-7

  CPCN
2-0-10-3      2-0-11-0      2-0-11-2      2-0-12-1
2-2-3-3      2-2-4-0      10-14-10-1

```

12. Verify whether or not either the LNP, ATINPQ, or ANSI41 AIQ feature is enabled, or the EIR, INP, V-Flex, or ANSI-41 INP Query feature is enabled and turned on by entering the `rtrv-ctrl-feat` command.

This list shows the entries that are displayed in the `rtrv-ctrl-feat` output for the features that are enabled, and turned on if required.

- LNP TNs with a quantity greater than zero - the LNP feature is enabled.
- EIR with the status `on` - the EIR feature is enabled and turned on.
- VFLEX with the status `on` - the V-Flex feature is enabled and turned on.
- ATINP - the ATINP feature is enabled.
- INP with the status `on` - the INP feature is enabled and turned on.
- ANSI-41 INP Query with the status `on` - the ANSI-41 INP Query feature is enabled and turned on.
- ANSI41 AIQ - the ANSI41 AIQ feature is enabled.

If the LNP, ATINPQ, or ANSI AIQ feature is enabled, or if the EIR, INP, V-Flex, or ANSI-41 INP Query feature is enabled and turned on, continue the procedure with 14.

13. Enable either the INP, ANSI-41 INP Query, EIR, V-Flex, ATINPQ, ANSI AIQ, or LNP features, depending on which subsystem you wish to use.

To use the INP subsystem, enable and turn on either the INP or ANSI-41 INP Query feature, perform the procedures in *INP/AINPQ User's Guide*.

To use the LNP subsystem, enable the LNP feature, perform the procedures in *ELAP Administration and LNP Feature Activation User's Guide*.

To use the EIR subsystem, enable and turn on the EIR feature, perform the procedures in *EIR User's Guide*.

To use the V-Flex subsystem, enable and turn on the V-Flex feature, perform the procedures in *V-Flex User's Guide*.

To use the ATINPQ subsystem, enable the ATINP feature, perform the procedures in *ATINP User's Guide*.

To use the AIQ subsystem, enable the ANSI AIQ feature, perform the procedures in *Analyzed Information Features User's Guide*.

 **Note:**

If the LNP feature is enabled, the INP, ANSI-41 INP Query, V-Flex, ATINPQ, or EIR features cannot be enabled.

14. Add the mated application to the database using the `ent-map` command. Use [Table 2-40](#) as a guide for the parameters and values that can be specified with the `ent-map` command.

Table 2-40 Solitary Mated Application Parameter Combinations

Other Subsystems	LNP Subsystem	INP Subsystem	EIR Subsystem
Mandatory Parameters			
:pc/pca/pci/pcn/ pcn24 (See Notes a, j, and n)	:pc/pca (See Note b)	:pcn/pcn24 (See Notes c and j)	:pci/pcn/pcn24 (See Notes d and j)
:ssn= <subsystem number, 2 - 255>	:ssn=<LNP subsystem number, 2 - 255>	:ssn=<INP subsystem number, 2 - 255>	:ssn=<EIR subsystem number, 2 - 255>
Optional Parameters			
:rc=<0 - 99> (See Note g)	:rc=<0 - 99> (See Note g)	:rc=<0 - 99> (See Note g)	:rc=<0 - 99> (See Note g)
:grp=<CSPC group name> (See Note h)	:grp=<CSPC group name> (See Note h)	:grp=<CSPC group name> (See Note h)	:grp=<CSPC group name> (See Note h)
:mrc=<yes, no> (See Note k)	:mrc=<yes, no> (See Note k)	:mrc=<yes, no> (See Note k)	:mrc=<yes, no> (See Note k)
:mapset=<new, dflt> (See Note i)	:mapset=dflt (See Note i)	:mapset=dflt (See Note i)	:mapset=dflt (See Note i)
:srm=<yes, no> (See Note k)	:srm=<yes, no> (See Note k)		
:sso=<on, off>			

Table 2-40 (Cont.) Solitary Mated Application Parameter Combinations

Other Subsystems	LNP Subsystem	INP Subsystem	EIR Subsystem
:mrnset = <MRN set ID from the <code>trv-mrn</code> output> (See Note l) :mrnpc/mrnpca/ mrnpci/mrnpcli/ mrnpcn24=<the point code value in the MRN set> (See Notes l and m)			
V-FLEX Subsystem	ATINPQ Subsystem	AIQ Subsystem	
Mandatory Parameters			
:pc/pca/pci/pcn/pcn24 (See Notes e and j)	:pc/pca/pci/pcn (See Notes f and j)	:pc/pca/pci/pcn/pcn24 (See Notes j and n)	
:ssn=<V-Flex subsystem number, 2 - 255>	:ssn=<ATINPQ subsystem number, 2 - 255>	:ssn=<AIQ subsystem number, 2 - 255>	
Optional Parameters			
:rc=<0 - 99> (See Note g)	:rc=<0 - 99> (See Note g)	:rc=<0 - 99> (See Note g)	
:grp=<CSPC group name> (See Note h)	:grp=<CSPC group name> (See Note h)	:grp=<CSPC group name> (See Note h)	
:mrc=<yes, no> (See Note k)	:mrc=<yes, no> (See Note k)	:mrc=<yes, no> (See Note k)	
:mapset=dflt (See Note i)	:mapset=dflt (See Note i)	:mapset=dflt (See Note i)	
:srm=<yes, no> (See Note k)	:srm=<yes, no> (See Note k)	:srm=<yes, no> (See Note k)	

 **Note:**

- a. The primary point code is an ANSI, ITU-I, ITU-I spare, ITU-N, ITU-N spare, or ITU-N24 from the `rtrv-rte` or `rtrv-map` outputs.
- b. The primary point code for the LNP subsystem is the ANSI point code from the `rtrv-sid` output.
- c. The primary point code for the INP subsystem is the ITU-N, ITU-N spare, or ITU-N24 point code from the `rtrv-sid` output.
- d. The primary point code for the EIR subsystem is the ITU-I, ITU-I spare, ITU-N, ITU-N spare, or ITU-N24 point code from the `rtrv-sid` output. Perform this step as necessary to provision an ITU-I and either a 14-bit ITU-N or a 24-bit ITU-N mated application containing the EIR subsystem.
- e. The primary point code for the V-Flex subsystem is the ANSI, ITU-I, ITU-I spare, ITU-N, ITU-N spare, or ITU-N24 point code from the `rtrv-sid` output. Perform this step as necessary to provision an ANSI, ITU-I, and either a 14-bit ITU-N or a 24-bit ITU-N mated application containing the VFLEX subsystem.
- f. The primary point code for the ATINPQ subsystem is the ANSI, ITU-I, ITU-I spare, ITU-N, or ITU-N spare point code from the `rtrv-sid` output. Perform this step as necessary to provision an ANSI, ITU-I, and a 14-bit ITU-N mated application containing the ATINPQ subsystem.
- g. The `rc` parameter can be specified for a solitary mated application, but does not have to be specified. If the `rc` parameter is not specified, its value will be 10.
- h. The format of the point codes in the CSPC group specified with the `grp` parameter must be the same as the primary point code specified with the `ent-map` command only if the ANSI/ITU SCCP Conversion feature is not enabled. If the ANSI/ITU SCCP Conversion feature is enabled, the CSPC group may contain a mixture of point code types (refer to the [Adding a Concerned Signaling Point Code](#) procedure), and the network type of the CSPC group can be different from the network type of the primary point code of the mated application.
- i. If the Flexible GTT Load Sharing is enabled, the `mapset` parameter must be specified with the `ent-map` command. If the Flexible GTT Load Sharing is not enabled, the `mapset` parameter cannot be specified with the `ent-map` command.

To provision entries in the default MAP set, the `mapset=dflt` parameter must be specified with the `ent-map` command.

To provision entries in a new MAP set, the `mapset=new` parameter must be specified with the `ent-map` command. When the `ent-map` command is executed with the `mapset=new` parameter, the new

MAP set ID is automatically generated and displayed in the output of the `ent-map` command as follows.

```
New MAPSET Created : MAPSETID = <new MAP set ID>
```

The default MAP set can contain multiple MAP groups. Each group in the default MAP set can contain a maximum of 128 point code and subsystem entries.

The point code and subsystem entry can appear only once in the default MAP set, so the point code and subsystem entry can appear in only one MAP group in the default MAP set.

The point code and subsystem entry provisioned in a MAP set can be provisioned in multiple MAP sets. If a point code and subsystem entry is provisioned in different MAP sets, the relative cost value of the entry in each MAP set can be different. All the point code and subsystem entries in a MAP set, including the default MAP set, must be different.

If the EAGLE's point code and subsystem number is being assigned to the mated application, and if the Flexible GTT Load Sharing feature is enabled, the EAGLE's point code and subsystem number can be assigned only to the default MAP set using the `mapset=df1t` parameter.

- j. If the point code selected from either the `rtrv-rte` or `rtrv-map` outputs is a 14-bit ITU-N point code, then the `pcn` parameter must be specified. If the point code selected from either the `rtrv-rte` or `rtrv-map` outputs is a 24-bit ITU-N point code, then the `pcn24` parameters must be specified.
- k. The `srm=yes` parameter can be specified only for solitary mated applications containing ANSI point codes. The `srm` parameter affects traffic only on dominant and combined dominant/load shared mated applications. The `mrc` parameter can be specified for a solitary mated application, but this parameter affects only the traffic for a dominant mated application. These are the default values for the `srm` and `mrc` parameters.
 - ANSI mated applications - `srm=yes`, `mrc=yes`
 - ITU mated applications - `srm=no` (for all ITU mated applications), `mrc=yes` (for ITU-I and ITU-N mated applications), `mrc=no` (for ITU-N24 mated applications)
- l. If either the `mrnset` or `mrnpc/mrnpca/mrnpai/mrnpn/mrnpn24` parameter is specified, then both parameters must be specified. The `mrnset` and `mrnpc/mrnpca/mrnpai/mrnpn/mrnpn24` parameters can be specified only if the GTT Load Sharing with Alternate Routing Indicator feature is enabled. Refer to the [Activating the GTT Load Sharing with Alternate Routing Indicator Feature](#) procedure for information about enabling the GTT Load Sharing with Alternate Routing Indicator feature. The `mrnset` and `mrnpc/mrnpca/mrnpai/mrnpn/mrnpn24` values must be shown in the `rtrv-mrn` output.

- m. The network type of the `pc/pca/pci/pcn/pcn24` and `mrnpc/mrnpca/mrnpai/mrnpai24` parameter values must be compatible, as shown in [Provisioning a Solitary Mated Application](#).
- n. The primary point code for the AIQ subsystem is the ANSI, ITU-I, ITU-I spare, ITU-N, ITU-N spare, or ITU-N24 point code from the `rtrv-sid` output. Perform this step as necessary to provision an ANSI, ITU-I, and either a 14-bit ITU-N or a 24-bit ITU-N mated application containing the AIQ subsystem.

If the Flexible GTT Load Sharing feature is not enabled for this example, enter these commands.

```
ent-map:pca=006-006-006:ssn=250:grp=grp15:sso=off
ent-map:pca=007-007-007:ssn=251:grp=grp05:sso=on
```

When each of these commands have successfully completed, this message should appear.

```
rlghncxa03w 07-05-07 11:44:13 GMT EAGLE5 37.0.0
ENT-MAP: MASP A - COMPLTD
```

If the Flexible GTT Load Sharing feature is enabled for this example, enter these commands.

```
ent-map:pca=006-006-006:ssn=250:grp=grp15:sso=off:mapset=new
ent-map:pca=007-007-007:ssn=251:grp=grp05:sso=on:mapset=df1t
```

If the GTT Load Sharing with Alternate Routing Indicator feature is enabled for this example, enter these commands.

```
ent-
map:pca=006-006-006:ssn=250:grp=grp15:sso=off:mapset=new :mrn
set=1:mrnpc=007-007-007
```

If the Flexible GTT Load Sharing feature is enabled when each of these commands have successfully completed, and a new MAP set was created, a message similar to the following should appear.

```
rlghncxa03w 07-05-07 11:44:13 GMT EAGLE5 37.0.0
New MAPSET Created : MAPSETID = 9
ENT-MAP: MASP A - COMPLTD
```

If the Flexible GTT Load Sharing feature is enabled when each of these commands have successfully completed, and the mated application was added to the default MAP set, this message should appear.

```
lghncxa03w 07-05-07 11:44:13 GMT EAGLE5 37.0.0
ENT-MAP: MASP A - COMPLTD
```

 **Note:**

If the Weighted GTT Load Sharing feature is enabled, shown by the columns `SWT,%WT`, and `THR` in the `rtrv-map` output, the parameters `swt,mwt`, and `thr` cannot be specified for a solitary mated application.

15. Verify the changes using the `rtrv-map` command with the primary point code and subsystem specified in 14.

If the `mapset=dflt` parameter was specified in 14, the `mapset=dflt` parameter should be specified with the `rtrv-map` command.

If a new MAP set was created in 14, the `mapset` parameter should be specified with the `rtrv-map` command. The value for the `mapset` parameter should be the MAP set ID generated in 14. If the mated application was added to an existing MAP set in 14, the `mapset` parameter and value specified in 14 should be specified with the `rtrv-map` command.

If the Flexible GTT Load Sharing feature is not enabled for this example, enter these commands.

```
rtrv-map:pca=006-006-006:ssn=250
```

This is an example of the possible output.

```
rlghncxa03w 09-07-07 00:34:31 GMT EAGLE5 41.1.0
```

PCA	Mate PCA	SSN	RC	MULT	SRM	MRC	GRP	NAME	SSO
006-006-006		250	10	SOL	*Y	*Y	grp15		OFF

```
MAP TABLE IS (37 of 1024) 4 % FULL
```

```
rtrv-map:pca=007-007-007:ssn=251
```

This is an example of the possible output.

```
rlghncxa03w 09-07-07 00:34:31 GMT EAGLE5 41.1.0
```

PCA	Mate PCA	SSN	RC	MULT	SRM	MRC	GRP	NAME	SSO
007-007-007		251	10	SOL	*Y	*Y	grp05		ON

```
MAP TABLE IS (37 of 1024) 4 % FULL
```

 **Note:**

If the Weighted GTT Load Sharing feature is enabled, the `WT,%WT`, and `THR` columns are shown in the `rtrv-map` output.

If the Flexible GTT Load Sharing feature is enabled for this example, enter these commands.

```
rtrv-map:pca=006-006-006:ssn=250:mapset=10
```

This is an example of the possible output.

```
rlghncxa03w 09-07-07 00:34:31 GMT EAGLE5 41.1.0

MAPSET ID=10      MRNSET=1          MRNPC=007-007-007
PCA              Mate PCA      SSN RC MULT SRM MRC GRP NAME SSO
006-006-006          250 10  SOL *Y *Y  grp15  OFF

MAP TABLE IS (37 of 36000) 1 % FULL
```

```
rtrv-map:pca=007-007-007:ssn=251:mapset=df1t
```

This is an example of the possible output.

```
rlghncxa03w 09-07-07 00:34:31 GMT EAGLE5 41.1.0

MAPSET ID=DFLT   MRNSET=-----   MRNPC=-----
PCA              Mate PCA      SSN RC MULT SRM MRC GRP NAME SSO
007-007-007          251 10  SOL *Y *Y  grp05  ON

MAP TABLE IS (37 of 36000) 1 % FULL
```

If the Weighted GTT Load Sharing feature is enabled, the WT, %WT, and THR columns are shown in the `rtrv-map` output.

If the GTT Load Sharing with Alternate Routing Indicator feature is not enabled, the MRNSET and MRNPC fields are not shown in the `rtrv-map` output.

16. Back up the new changes using the `chg-db:action=backup:dest=fixed` command.

These messages should appear, the active Maintenance and Administration Subsystem Processor (MASP) appears first.

```
BACKUP (FIXED) : MASP A - Backup starts on active MASP.
BACKUP (FIXED) : MASP A - Backup on active MASP to fixed disk
complete.
BACKUP (FIXED) : MASP A - Backup starts on standby MASP.
BACKUP (FIXED) : MASP A - Backup on standby MASP to fixed disk
complete.
```

Figure 2-52 Provision a Solitary Mated Application - Sheet 1 of 11

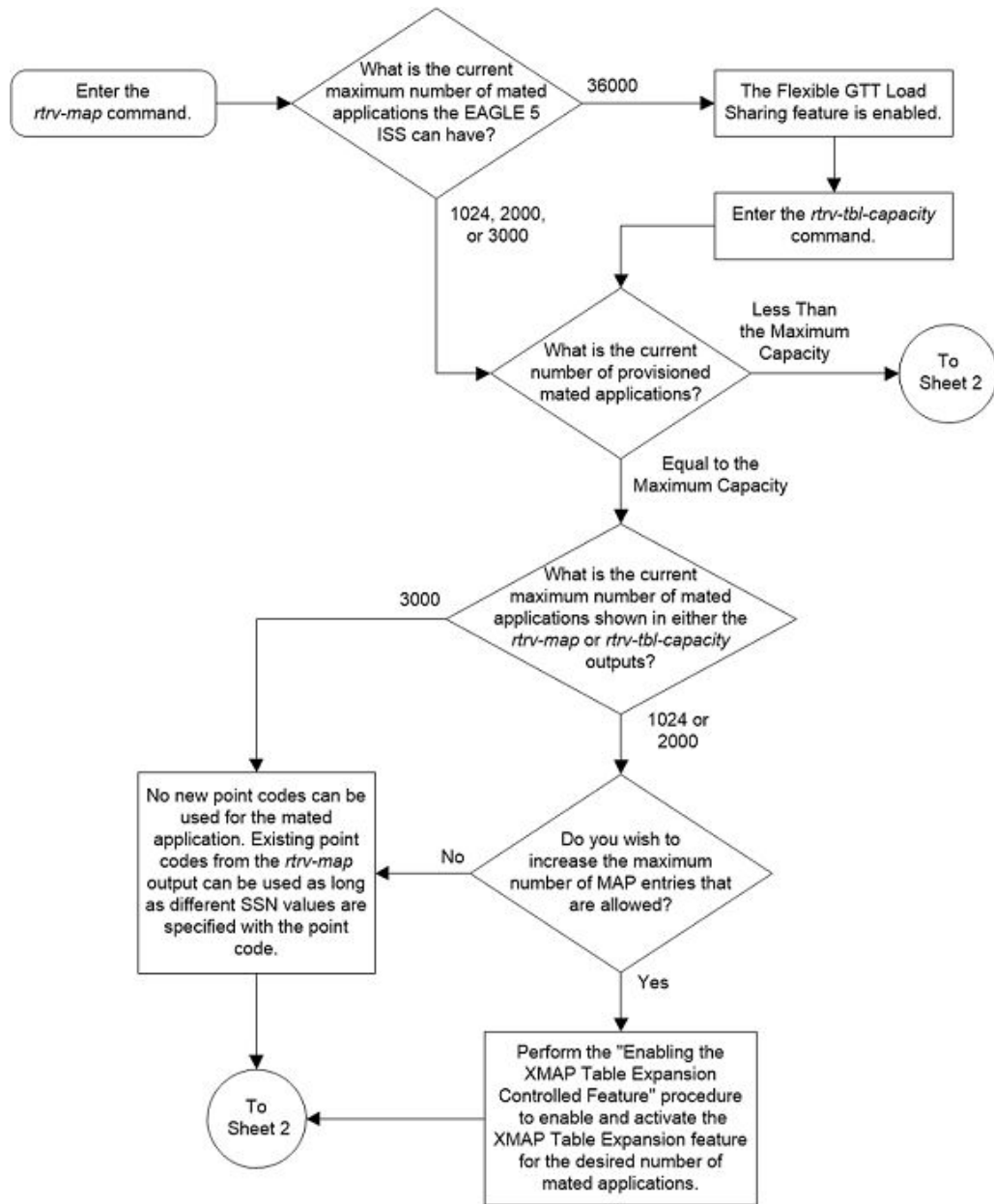

Figure 2-53 Provision a Solitary Mated Application - Sheet 2 of 11

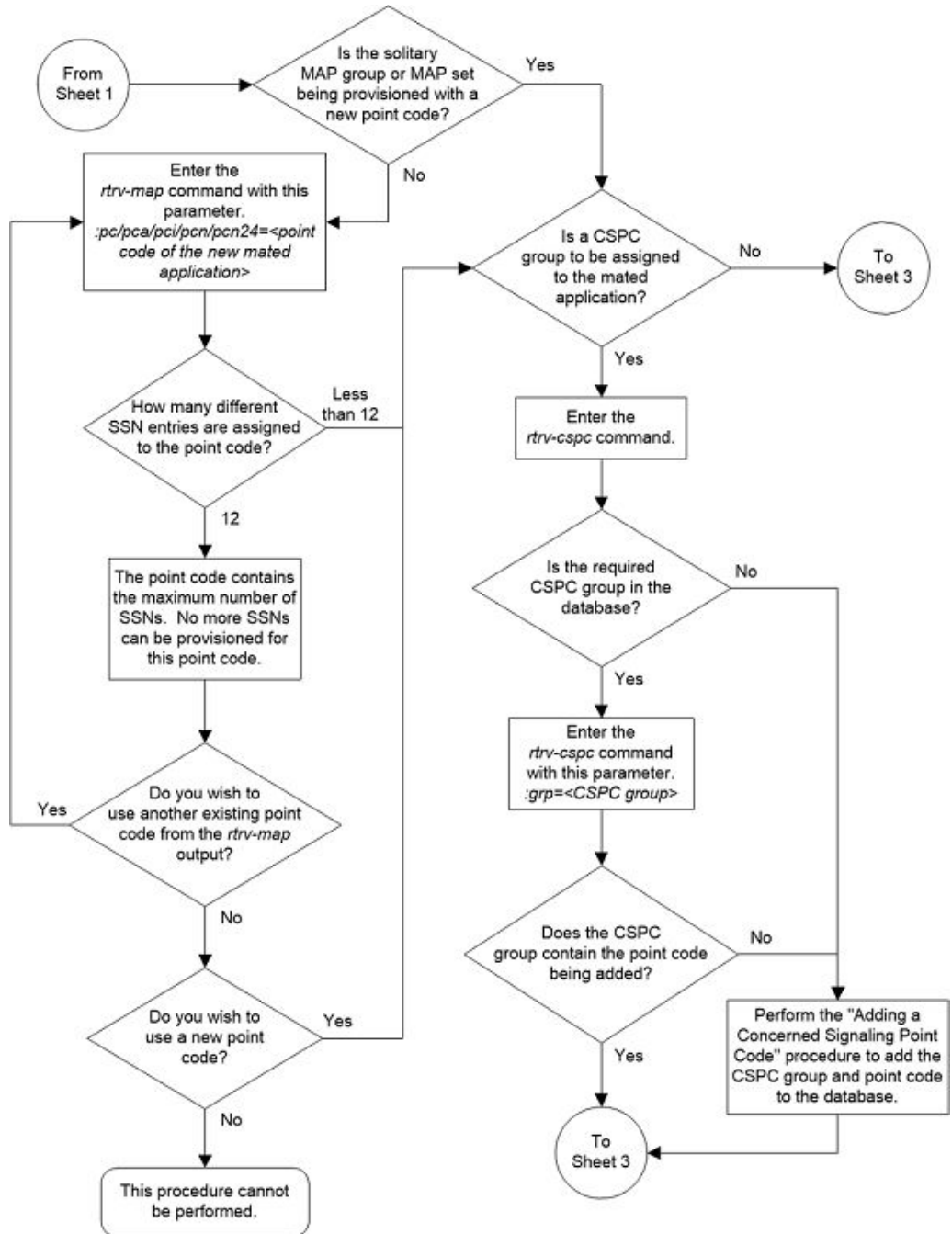

Figure 2-54 Provision a Solitary Mated Application - Sheet 3 of 11

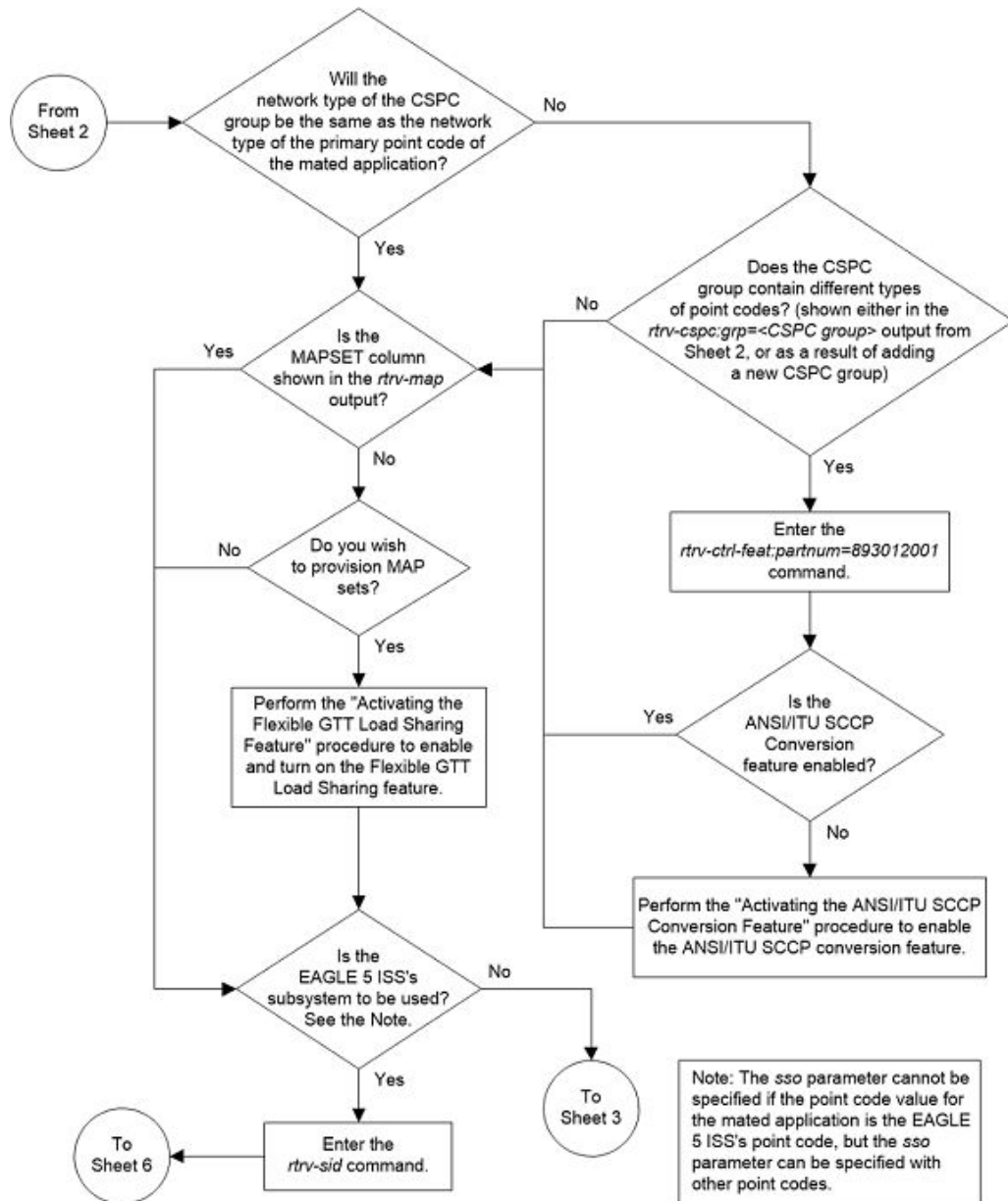

Figure 2-55 Provision a Solitary Mated Application - Sheet 4 of 11

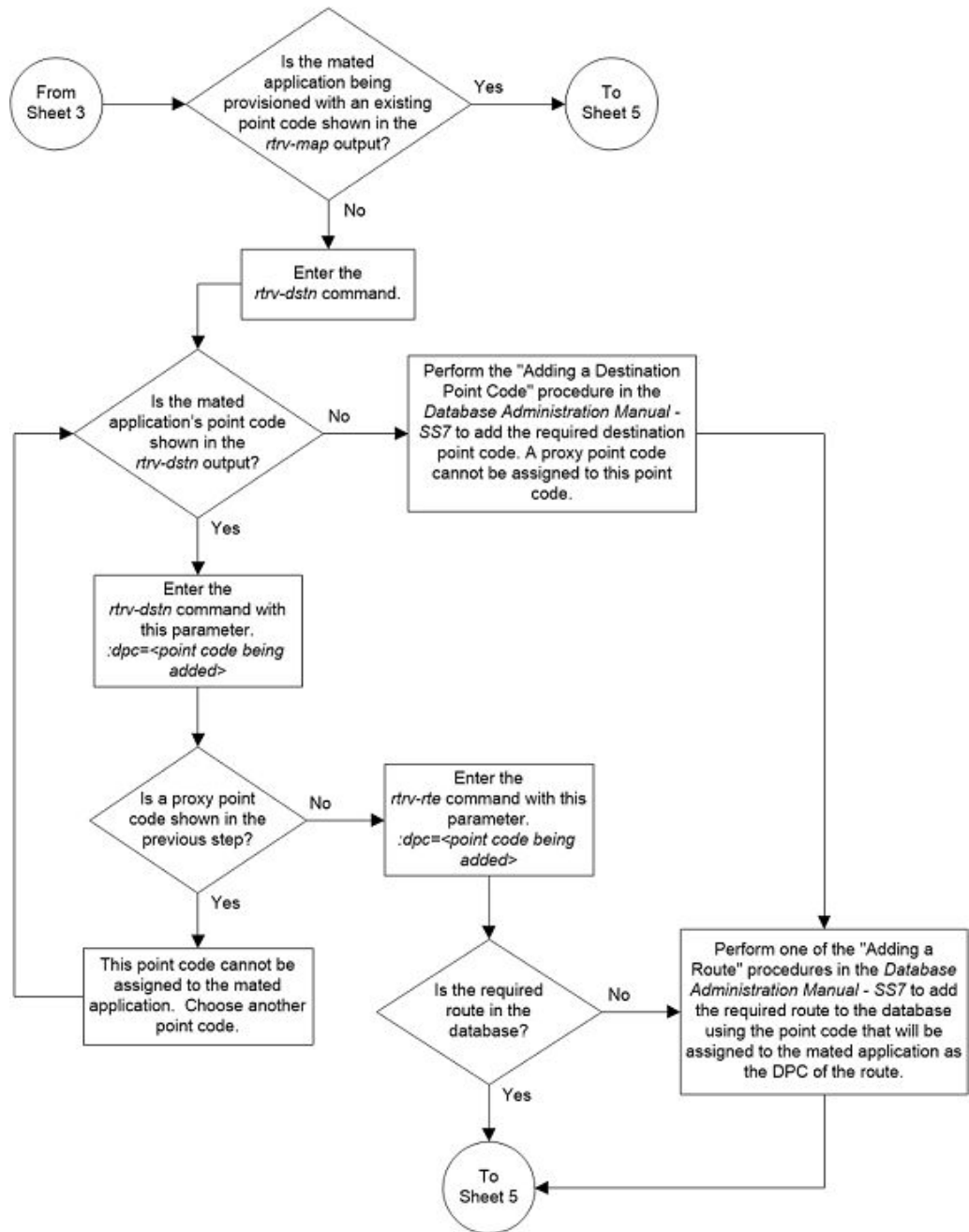

Figure 2-56 Provision a Solitary Mated Application - Sheet 5 of 11

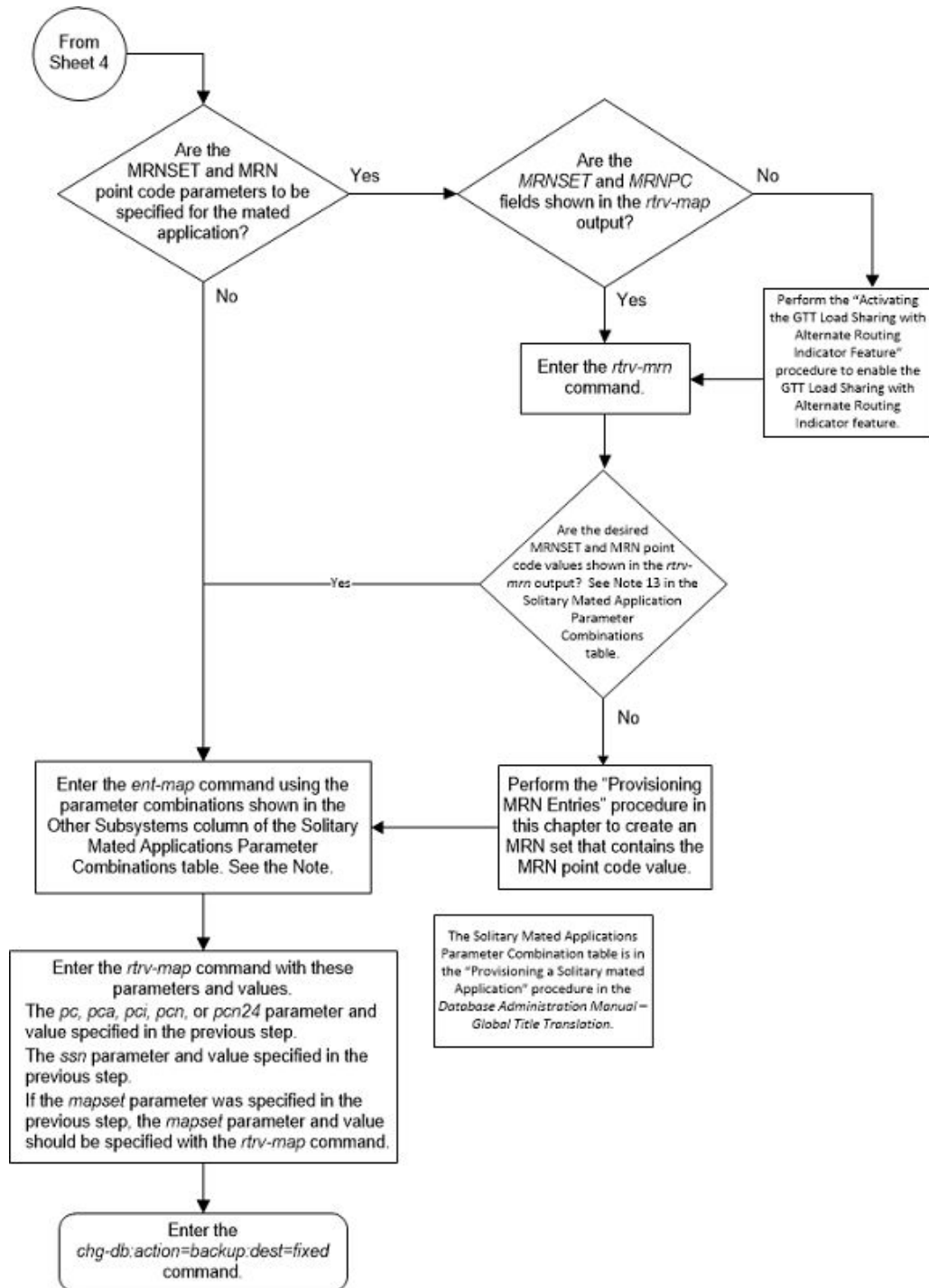

Figure 2-57 Provision a Solitary Mated Application - Sheet 6 of 11

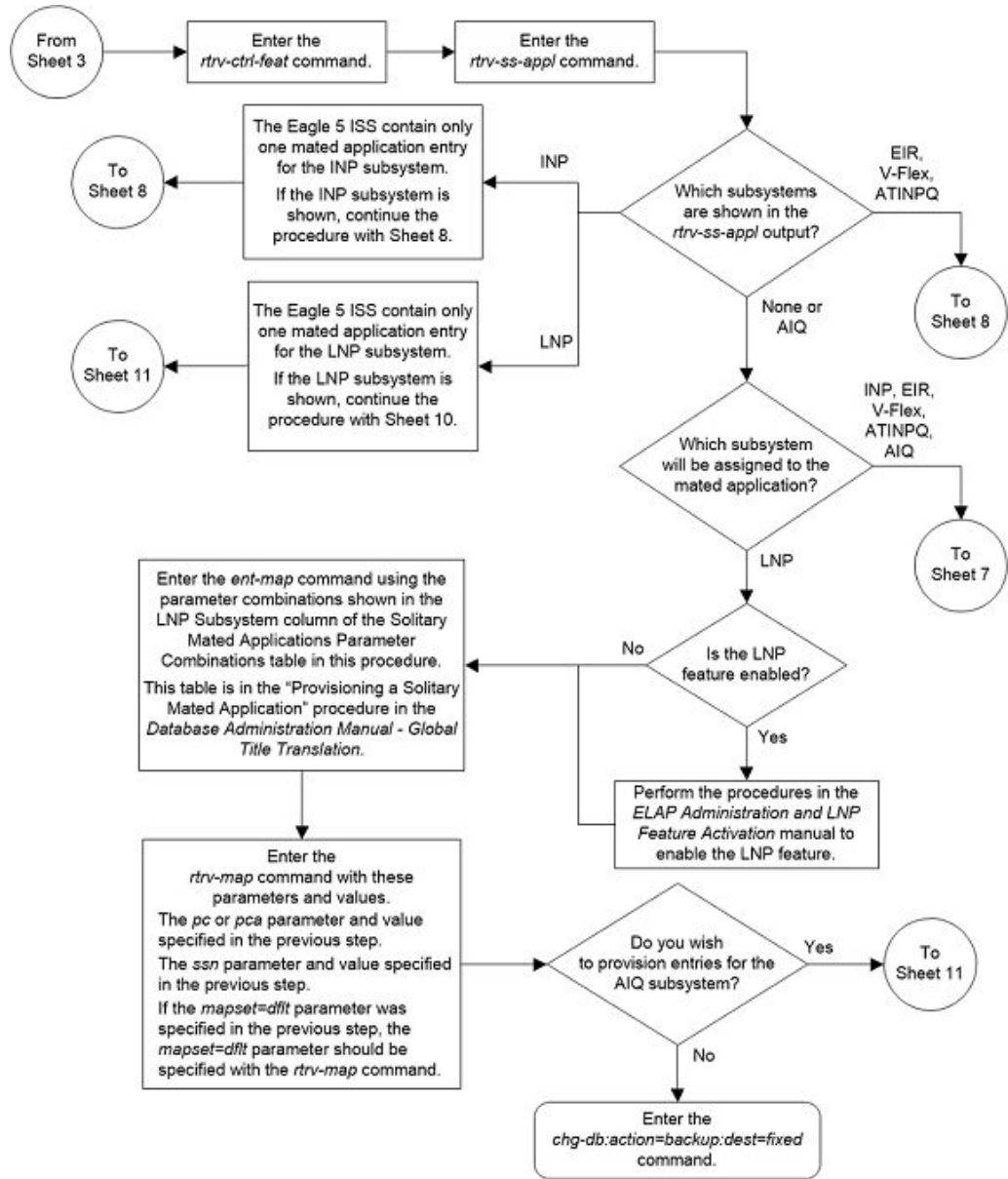

Figure 2-58 Provision a Solitary Mated Application - Sheet 7 of 11

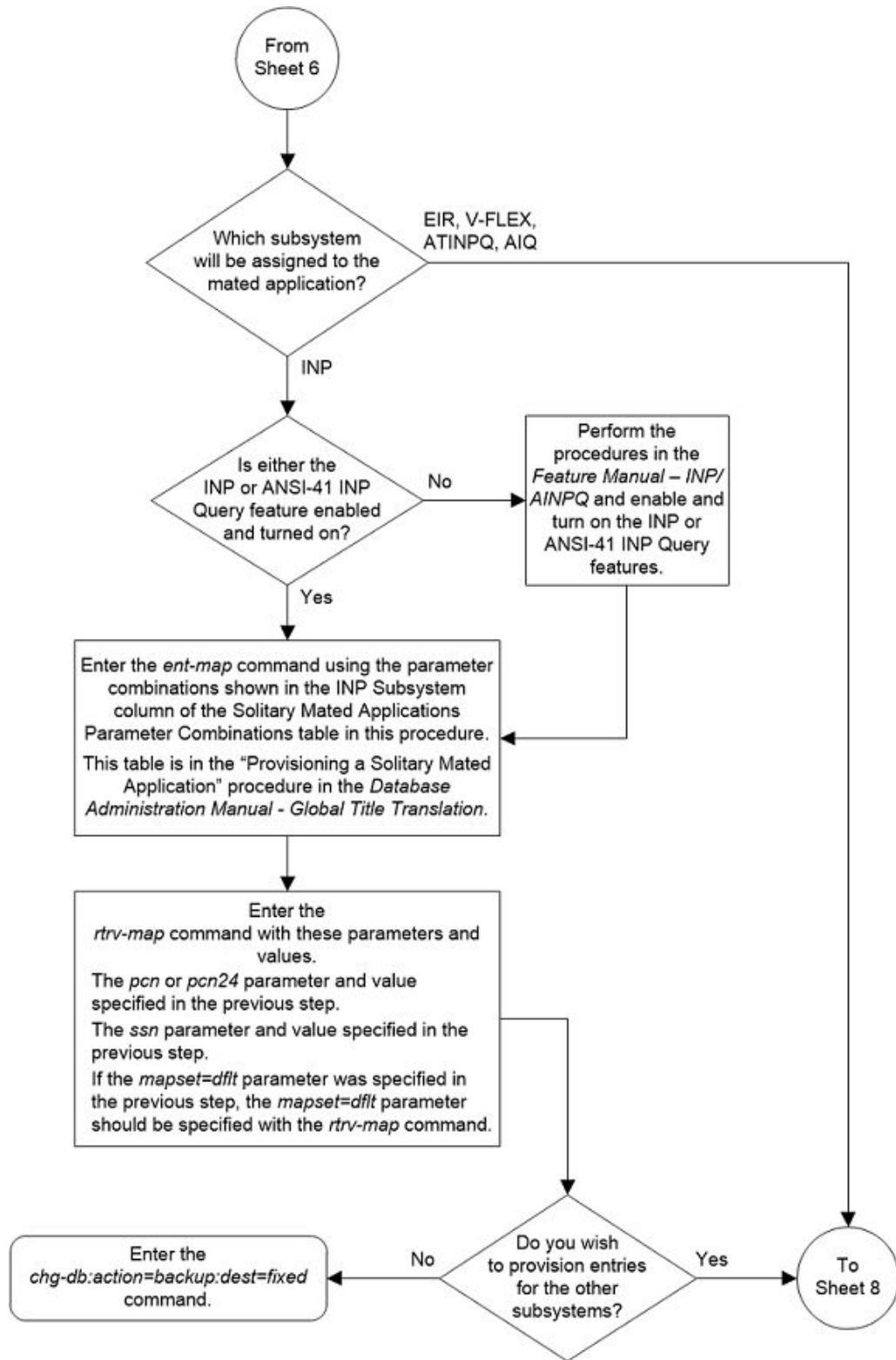

Figure 2-59 Provision a Solitary Mated Application - Sheet 8 of 11

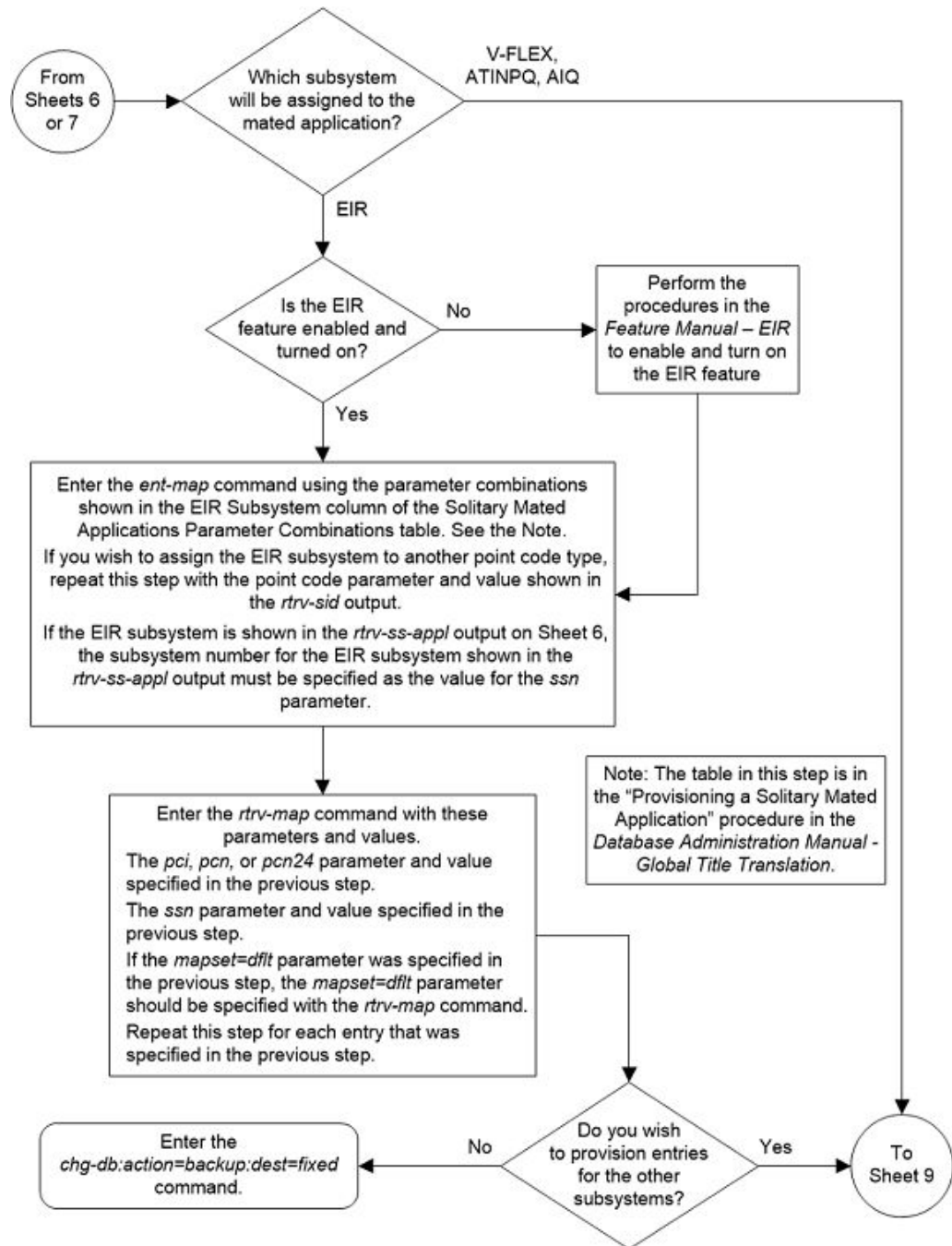

Figure 2-60 Provision a Solitary Mated Application - Sheet 9 of 11

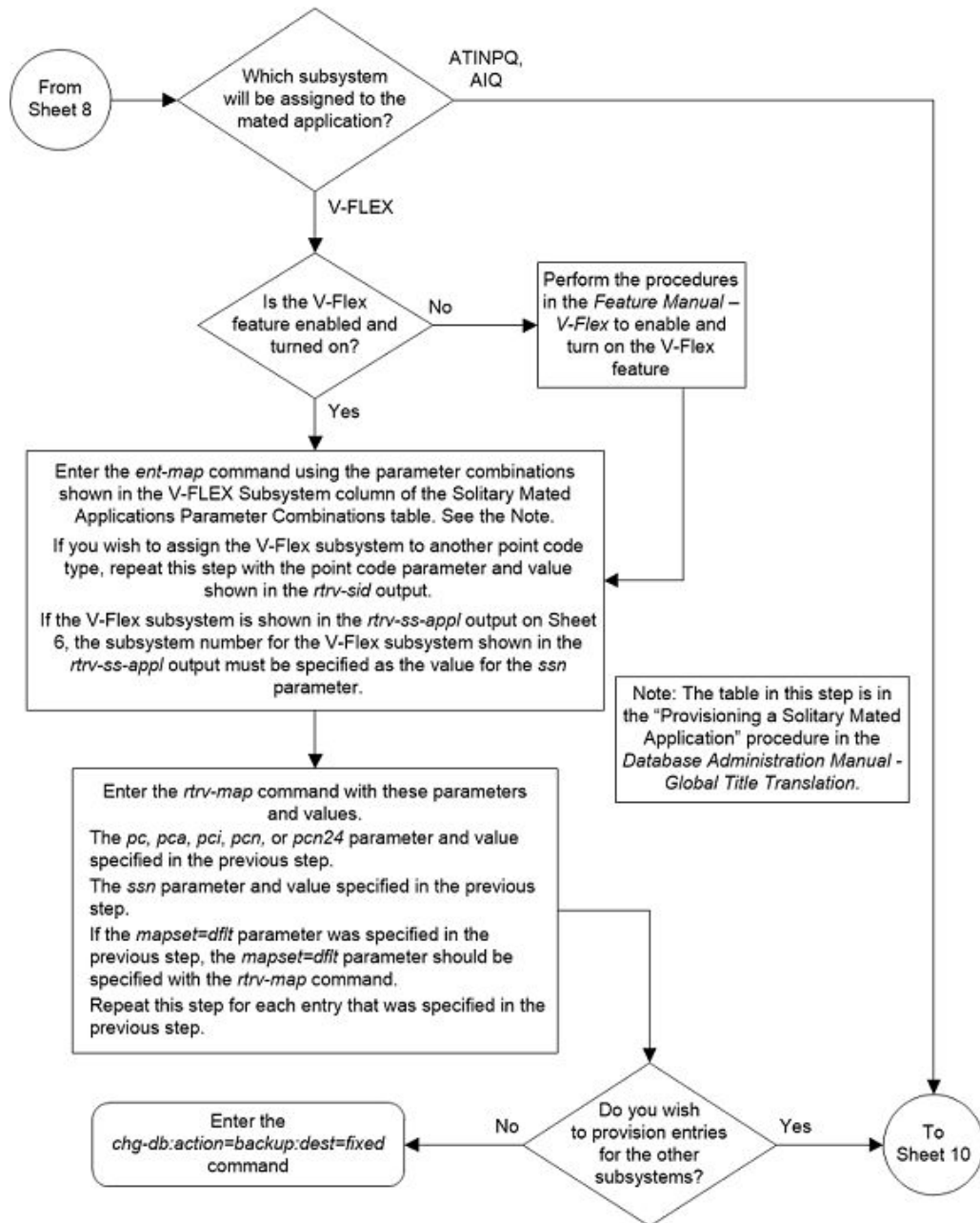

Figure 2-61 Provision a Solitary Mated Application - Sheet 10 of 11

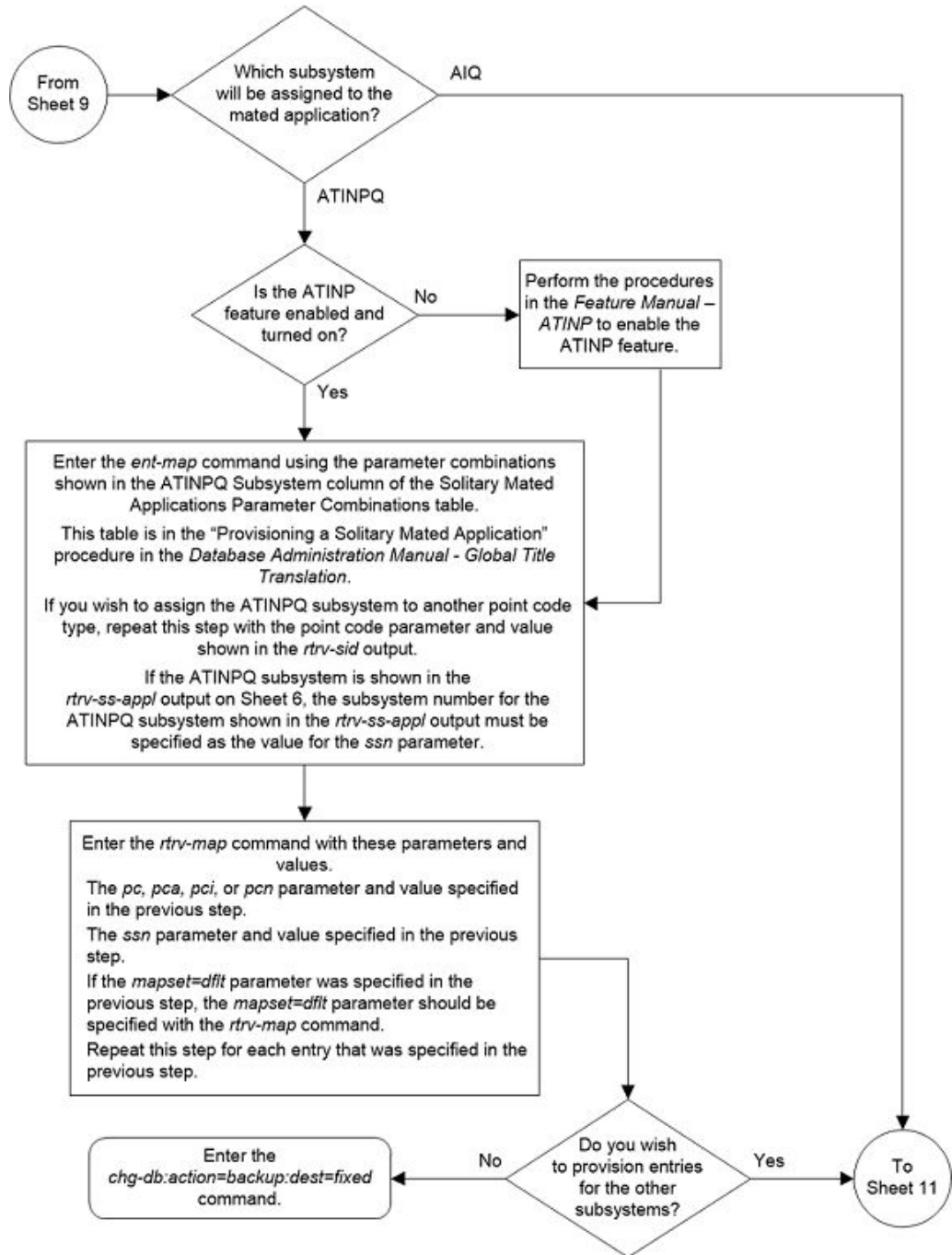
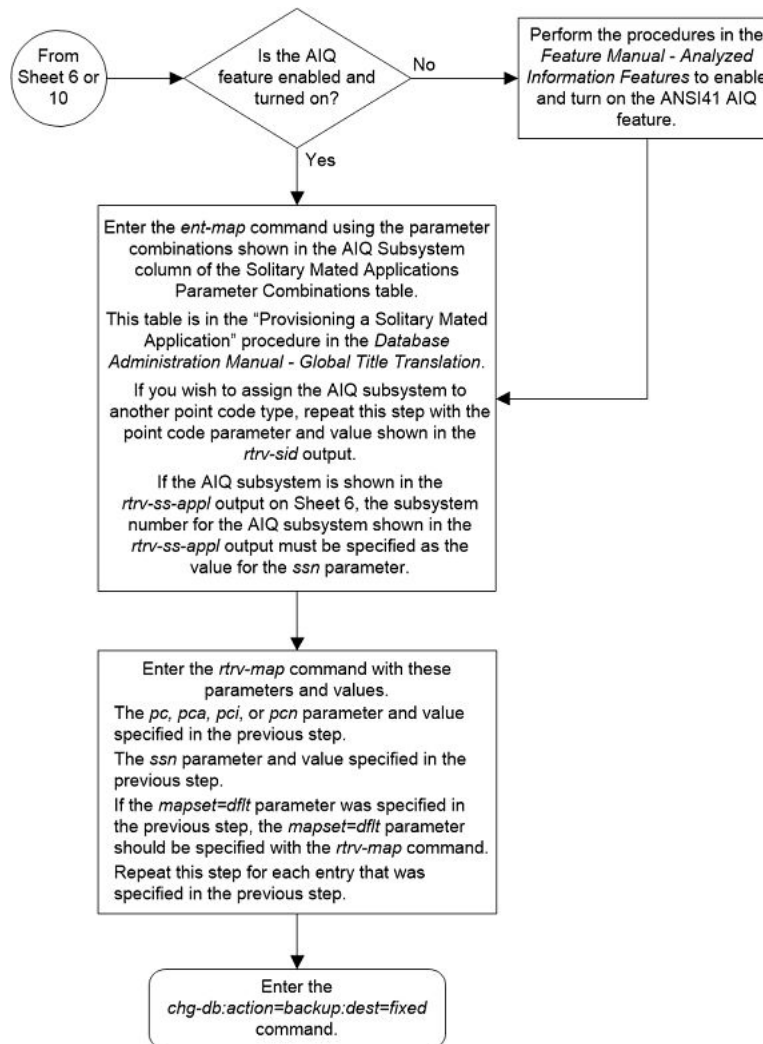

Figure 2-62 Provision a Solitary Mated Application - Sheet 11 of 11



Provisioning a Dominant Mated Application

This procedure is used to provision a dominant mated application in the database using the `ent-map` and `chg-map` commands. A dominant mated application is a mated application containing entries whose RC (relative cost) values are unique. The `ent-map` and `chg-map` commands use these parameters to provision a dominant mated application.

`:pc/pca/pci/pcn/pcn24` – The point code of the primary signaling point that is to receive the message.

`:mpc/mpca/mpci/mpcn/mpcn24` – The point code of the backup signaling point that is to receive the message.

 **Note:**

The point codes can be either an ANSI point code (*pc/PCA, MPC/MPCA*), ITU-I or ITU-I spare point code (*pci, MPCi*), a 14-bit ITU-N or 14-bit ITU-N spare point code (*pcn, MPCn*), or a 24-bit ITU-N (*pcn24, MPCn24*) point code.

 **Note:**

Refer to Chapter 2, Configuring Destination Tables in *Database Administration - SS7 User's Guide* for a definition of the point code types that are used on the EAGLE and for a definition of the different formats that can be used for ITU national point codes.

:ssn – Subsystem number – the subsystem address of the primary point code that is to receive the message. The value for this parameter is 2 to 255.

:mssn – Mate subsystem number – the subsystem address of the backup point code that is to receive the message. The value for this parameter is 2 to 255.

:rc – The relative cost value of the primary point code and subsystem, defined by the *pc/PCA/pci/PCn/PCn24* and *ssn* parameters. The *rc* parameter has a range of values from 0 to 99, with the default value being 10.

:materc – The relative cost value of the backup point code and subsystem, defined by the *MPC/MPCA/MPCi/MPCn/MPCn24* and *mssn* parameters. The *materc* parameter has a range of values from 0 to 99, with the default value being 50.

:grp – The name of the concerned signaling point code (CSPC) group that contains the point codes that should be notified of the subsystem status. This parameter applies to both RPCs/SSNs. The value for this parameter is shown in the *rtrv-cspc* output. If the desired value is not shown in the *rtrv-cspc* output, perform the [Adding a Concerned Signaling Point Code](#) procedure to add the desired group. If this parameter is not specified, then a CSPC group name is not specified for the mated application.

:mrc – Message routing under congestion – defines the handling of Class 0 messages during congestion conditions. The value for this parameter is *yes* or *no*. The default value for ANSI dominant mated applications is *yes*. The default value for ITU dominant mated applications is *no*.

:srm – Subsystem routing messages – defines whether subsystem routing messages (SBR, SNR) are transmitted between the mated applications.

:sso – Subsystem Status Option – defines whether the subsystem status option is on or off. This parameter allows the user the option to have the specified subsystem marked as prohibited even though an MTP-RESUME message has been received by the indicating that the specified point code is allowed. The *sso* parameter cannot be specified if the *pc/PCA/pci/PCn/PCn24* value is the EAGLE's true point code, shown in the *rtrv-sid* output. The value for this parameter is *on* or *off*. The default value is *off*.

:mapset – The MAP set ID that the mated applications are assigned to. This parameter can be specified only if the Flexible GTT Load Sharing feature is enabled. This parameter must be specified if the Flexible GTT Load Sharing feature is enabled.

If the Flexible GTT Load Sharing feature is enabled, the point code and subsystem specified for the global title translation must be assigned to the MAP set specified by this parameter. The status of the Flexible GTT Load Sharing feature is shown in the `rtrv-ctrl-feat` output. To enable the Flexible GTT Load Sharing feature, perform the [Activating the Flexible GTT Load Sharing Feature](#) procedure.

The `mapset` parameter has three values:

- `df1t` – to assign the MAP to the default MAP set. This value can be specified with both the `ent-map` and `chg-map` commands.
- `new` – to assign the mated application to a new MAP set. This value can be specified only with the `ent-map` command.
- the specific number of an existing MAP set if you are assigning the mated application to an existing MAP set. This value can be specified only with the `chg-map` command.

Refer to the [Provisioning a MAP Set](#) section for information on provisioning MAP sets.

`:mrnset` – The MRN set ID that is being assigned to the mated application. This is the MRN set from which alternate routing indicator searches are performed.

`:mrnpc/mrnpca/mrnpai/mrnpai/mrnpai24` – The point code assigned to the `mrnset` that is being assigned to the MAP set.

The current values of the `mrnset` and `:mrnpc/mrnpca/mrnpai/mrnpai/mrnpai24` parameters are shown in the `rtrv-map` output only if the Flexible GTT Load Sharing and the GTT Load Sharing with Alternate Routing Indicator features are enabled.

The new values for the `mrnset` and `mrnpc/mrnpca/mrnpai/mrnpai/mrnpai24` parameters must be shown in the `rtrv-mrn` output.

The network type of the `pc/pca/pai/pai/pai24` and `mrnpc/mrnpca/mrnpai/mrnpai/mrnpai24` parameter values must be compatible, as shown in [Table 2-41](#).

Table 2-41 MAP and MRN Point Code Parameter Combinations

MAP Point Code Parameter	MRN Point Code Parameter
<code>pc/pca</code>	<code>mrnpc/mrnpca</code>
<code>pai</code> or <code>pai</code> (See Notes 1 and 2)	<code>mrnpai</code> or <code>mrnpai</code> (See Notes 1 and 2)
<code>pai24</code>	<code>mrnpai24</code>
Notes:	
1. If the network type of the MAP point code parameter is ITU-I (<code>pai</code>), the network type of the MRN point code parameter can be either ITU-I (<code>mrnpai</code>) or ITU-N (<code>mrnpai</code>).	
2. If the network type of the MAP point code parameter is ITU-N (<code>pai</code>), the network type of the MRN point code parameter can be either ITU-I (<code>mrnpai</code>) or ITU-N (<code>mrnpai</code>).	

If the Weighted GTT Load Sharing feature is enabled, shown by the columns `WT`, `%WT`, and `THR` in the `rtrv-map` output, the parameters `wt`, `mwt`, and `thr` cannot be specified for a dominant mated application. If you wish to use these parameters to provision a mated application, perform one of these procedures:

- [Provisioning a Load Shared Mated Application](#)
- [Provisioning a Combined Dominant/Load Shared Mated Application.](#)

A dominant mated application can contain up to 128 point codes and subsystems, a primary point code and subsystem, and up to 31 mated point codes and subsystems. When a new dominant mated application is added to the database, the first two entries, the primary point code and subsystem and a mate point code and subsystem are added using the `ent-map` command. All other mated point code and subsystem entries that are being assigned to the primary point code and subsystem are added to the dominant mated application using the `chg-map` command.

All the point codes and subsystems in a dominant mated application have different relative cost values, with the primary point code and subsystem having the lowest relative cost value. All traffic is routed to the primary point code and subsystem, if it is available. If the primary point code and subsystem becomes unavailable, the traffic is routed to highest priority backup point code and subsystem that is available. When the primary point code and subsystem becomes available again, the traffic is then routed back to the primary point code and subsystem.

If the Flexible GTT Load Sharing feature is not enabled, the primary point code and subsystem number or the mate point code and mate subsystem number combination can be in the database only once. If the Flexible GTT Load Sharing feature is enabled, the primary point code and subsystem number or mate point code and mate subsystem number combination can be in multiple MAP sets, but can be in the default MAP set only once. Refer to the [Provisioning a MAP Set](#) section for information on provisioning MAP sets.

The point codes specified in the `ent-map` or `chg-map` commands (`pc/pca`, `pci`, `pcn`, or `pcn24`, and `mpc/mpca`, `mpci`, `mpcn`, or `mpcn24`) must be either a full point code in the routing point code table or the EAGLE's true point code. Cluster point codes or network routing point codes cannot be specified with this command. The `rtrv-rte` command can be used to verify the point codes in the routing table. The point codes in the routing table are shown in the `DPCA`, `DPCI`, `DPCN`, or `DPCN24` fields of the `rtrv-rte` command output. The EAGLE's true point code is shown in the `PCA`, `PCI`, `PCN`, or `PCN24` fields of the `rtrv-sid` command output.

A dominant mated application can be provisioned with a point code that is assigned to other mated applications as long as the SSN is not assigned to other mated applications. A point code can be assigned to maximum of 12 different SSNs.

If the EAGLE's true point code is specified in the mated application, it must be the primary point code. The relative cost value assigned to this point code must be the lowest value in the mated application. If the Flexible GTT Load Sharing feature is enabled, the mated application containing the EAGLE's true point code can be assigned only to the default MAP set.

A mated application containing the LNP subsystem can contain only ANSI point codes. The primary point code (`pc` or `pca`) must be the EAGLE's true ANSI point code. The LNP feature must be enabled for a quantity greater than zero.

A mated application containing the INP subsystem can contain only 14-bit ITU-N point codes, 14-bit ITU-N spare point codes, or 24-bit ITU-N point codes. The primary point code (`pcn` or `pcn24`) must be the EAGLE's true 14-bit ITU-N point code, 14-bit ITU-N spare point code, or 24-bit ITU-N point code. The INP or ANSI-41 INP Query feature must be enabled and turned on. The EAGLE can contain either 14-bit ITU-N point codes (spare or non-spare point codes) or 24-bit ITU-N point codes. Both types of point codes cannot be present on the EAGLE at the same time.

A mated application containing the EIR subsystem can contain only ITU-I point codes, ITU-I spare point codes, 14-bit ITU-N point codes, 14-bit ITU-N spare point codes, or

24-bit ITU-N point codes. The primary point code (`pci`, `pcn`, or `pcn24`) must be the EAGLE's true ITU-I point code, ITU-I spare point code, 14-bit ITU-N point code, 14-bit ITU-N spare point code, or 24-bit ITU-N point code. The EIR feature must be enabled and turned on. The EAGLE can contain either 14-bit ITU-N point codes (spare or non-spare point codes) or 24-bit ITU-N point codes. Both types of point codes cannot be present on the EAGLE at the same time.

A mated application containing the VFLEX subsystem can contain any type of point code. The primary point code (`pc`, `pca`, `pci`, `pcn`, or `pcn24`) must be the EAGLE's true point code. The V-Flex feature must be enabled and turned on. The EAGLE can contain either 14-bit ITU-N point codes (spare or non-spare point codes) or 24-bit ITU-N point codes. Both types of point codes cannot be present on the EAGLE at the same time.

A mated application containing the ATINPQ subsystem can contain only ANSI point codes, ITU-I point codes, ITU-I spare point codes, 14-bit ITU-N point codes, or 14-bit ITU-N spare point codes. The primary point code (`pc`, `pca`, `pci`, or `pcn`) must be the EAGLE's true ANSI point code, ITU-I point code, ITU-I spare point code, 14-bit ITU-N point code, or 14-bit ITU-N spare point code. The ATINP feature must be enabled.

A mated application containing the AIQ subsystem can contain any of the EAGLE's true point codes. The ANSI41 AIQ feature must be enabled. The EAGLE can contain either 14-bit ITU-N point codes (spare or non-spare point codes) or 24-bit ITU-N point codes. Both types of point codes cannot be present on the EAGLE at the same time.

The EAGLE can contain multiple entries that contain the EAGLE's true point code, shown in the `rtrv-sid` output. [Table 2-42](#) shows the numbers of entries that can be provisioned based on the type of point code.

Table 2-42 Maximum Number of True Point Code Entries

True Point Code Type	Maximum Number of Entries
ANSI	1 - for the LNP subsystem 2 - one entry for the LNP subsystem and one entry for the AIQ subsystem 3 - one entry for the ATINPQ subsystem, one entry for the V-FLEX subsystem, and one entry for the AIQ subsystem The LNP subsystem cannot be used if the ATINPQ, EIR, INP, and V-FLEX subsystems are used.
ITU-I	4 - one entry for the ATINPQ subsystem, one entry for the EIR subsystem, one entry for the V-FLEX subsystem, and one entry for the AIQ subsystem
ITU-N	5 - one entry for the ATINPQ subsystem, one entry for the EIR subsystem, one entry for the INP subsystem, one entry for the V-FLEX subsystem, and one entry for the AIQ subsystem

For mated applications containing ANSI or 24-bit ITU-N point codes, or the EAGLE's true point code, the format of the point codes specified in the `ent-map` command must be the same. For example, if the primary point code is a 24-bit ITU-N point code (`pcn24`), the mate point code must be a 24-bit ITU-N point code (`mpcn24`). The mate

point codes of mated applications containing either ITU-I, ITU-I spare, 14-bit ITU-N, or 14-bit ITU-N spare primary point codes do not have to be the same format as the primary point code. The mate point codes of these mated applications can be a mixture of ITU-I, ITU-I spare, 14-bit ITU-N, or 14-bit ITU-N spare point codes.

The format of the point codes in the CSPC group specified with the `grp` parameter must be the same as the primary point code specified with the `ent-map` command only if the ANSI/ITU SCCP Conversion feature is not enabled. If the ANSI/ITU SCCP Conversion feature is enabled, the CSPC group may contain a mixture of point code types (refer to the [Adding a Concerned Signaling Point Code](#) procedure), and the network type of the CSPC group can be different from the network type of the primary point code of the mated application. The status of the ANSI/ITU SCCP Conversion feature can be verified with the `rtrv-ctrl-feat` command.

The values for the primary point code and subsystem combination (`pc/ssn`) cannot be the same as the mated point code and subsystem combination (`mpc/mssn`). However, the primary and mated point codes can be the same as long as the subsystem numbers are different.

If a mate point code (`mpc/mpca/mpci/mpcn/mpcn24`) is specified, the `mssn` parameter must be specified.

If the `mssn` parameter is specified, the mate point code (`mpc/mpca/mpci/mpcn/mpcn24`) must be specified.

If the `grp`, `srn`, `mrc`, and `sso` parameter values are specified, and the specified point code and SSN is assigned to multiple mated applications, the `grp`, `srn`, `mrc`, and `sso` values for all mated applications containing the specified point code and SSN will be changed to the values specified in this procedure.

The EAGLE can contain 1024, 2000, or 3000 mated applications. The EAGLE default is 1024 mated applications. This quantity can be increased to 2000 by enabling the feature access key for part number 893-0077-01, or to 3000 by enabling the feature access key for part number 893-0077-10. For more information on enabling these feature access keys, refer to the [Enabling the XMAP Table Expansion Feature](#) procedure.

Provisioning a MAP Set

The Flexible GTT Load Sharing feature provides the ability to define multiple load sharing sets in the MAP table where the same point code and subsystem can be assigned to different load sharing sets.

The MAP table contains specific load sharing sets, designated by numbers, and a default MAP set.

Flexible Final GTT Load Sharing provides flexible load sharing for global title translations defined in the GTT table and not for the MPS-based features. The MPS-based features do not support the MAP set ID parameter. The MPS-based features perform lookups for load sharing in the default MAP set and the GTT table. The entries in the GTT table can be linked to a MAP set ID, allowing lookups in a specific MAP set other than the default MAP set.

Any MAP entries that were provisioned in the database before the Flexible GTT Load Sharing feature is enabled are placed in the default MAP set when the Flexible GTT Load Sharing feature is enabled.

To provision entries in the default MAP set, the `mapset=dflt` parameter must be specified with the `ent-map` or `chg-map` commands.

To provision entries in an existing MAP set other than the default MAP set, the `mapset=<MAP set ID>` parameter must be specified with the `chg-map` command. Provisioning entries in an existing MAP set can be performed only with the `chg-map` command.

To provision entries in a new MAP set, the `mapset=new` parameter must be specified with the `ent-map` command. The `mapset=new` parameter can be specified only with the `ent-map` command. When the `ent-map` command is executed with the `mapset=new` parameter, the new MAP set ID is automatically generated and displayed in the output of the `ent-map` command as follows.

```
New MAPSET Created : MAPSETID = <new MAP set ID>
```

A MAP set, other than the default MAP set, is a MAP group provisioned with the MAP set ID and can contain a maximum of 32 point codes.

The default MAP set can contain multiple MAP groups. The point code and subsystem number combination can appear only once in the default MAP set. The point code can appear in multiple MAP groups in the default MAP set with different subsystem numbers.

The point code and subsystem number combination provisioned in a MAP set can be provisioned in multiple MAP sets. All the point code and subsystem number combinations in a MAP set must be different.

Canceling the `RTRV-MAP` Command

Because the `rtrv-map` command used in this procedure can output information for a long period of time, the `rtrv-map` command can be canceled and the output to the terminal stopped. There are three ways that the `rtrv-map` command can be canceled.

- Press the `F9` function key on the keyboard at the terminal where the `rtrv-map` command was entered.
- Enter the `canc-cmd` without the `trm` parameter at the terminal where the `rtrv-map` command was entered.
- Enter the `canc-cmd:trm=<xx>`, where `<xx>` is the terminal where the `rtrv-map` command was entered, from another terminal other than the terminal where the `rtrv-map` command was entered. To enter the `canc-cmd:trm=<xx>` command, the terminal must allow Security Administration commands to be entered from it and the user must be allowed to enter Security Administration commands. The terminal's permissions can be verified with the `rtrv-secu-trm` command. The user's permissions can be verified with the `rtrv-user` or `rtrv-secu-user` commands.

For more information about the `canc-cmd` command, refer to *Commands User's Guide*.

1. Display the mated applications in the database using the `rtrv-map` command.

This is an example of the possible output.

```
rlghncxa03w 09-07-07 00:34:31 GMT EAGLE5 41.1.0
```

```
MAPSET ID=DFLT
```

```
PCA          Mate PCA          SSN RC MULT SRM MRC GRP NAME SSO
```

```

255-001-000                250 10 SOL *Y *Y grp01 ON

MAPSET ID=1
PCA      Mate PCA      SSN RC MULT SRM MRC GRP NAME SSO
255-001-000                251 10 SHR *Y *Y grp01 OFF
                253-001-002 254 10 SHR *Y *Y grp01 OFF

MAPSET ID=2
PCA      Mate PCA      SSN RC MULT SRM MRC GRP NAME SSO
255-001-000                252 10 SOL *Y *Y grp01 ON

MAPSET ID=DFLT
PCA      Mate PCA      SSN RC MULT SRM MRC GRP NAME SSO
255-001-000                253 10 SHR *Y *Y grp01 OFF
                253-001-004 254 10 SHR *Y *Y grp01 OFF

MAPSET ID=3
PCA      Mate PCA      SSN RC MULT SRM MRC GRP NAME SSO
255-001-001                255 10 DOM YES YES grp01 ON
                253-001-005 254 20 DOM YES YES grp01 ON

MAPSET ID=4
PCA      Mate PCA      SSN RC MULT SRM MRC GRP NAME SSO
255-001-001                250 10 DOM YES YES grp01 OFF
                253-001-001 254 20 DOM YES YES grp01 OFF

MAPSET ID=DFLT
PCA      Mate PCA      SSN RC MULT SRM MRC GRP NAME SSO
255-001-002                251 10 SHR *Y *Y grp01 OFF
                255-001-002 254 10 SHR *Y *Y grp01 OFF

MAPSET ID=5
PCA      Mate PCA      SSN RC MULT SRM MRC GRP NAME SSO
255-001-002                252 10 DOM YES YES grp01 ON
                255-001-003 254 20 DOM YES YES grp01 ON

MAPSET ID=6
PCA      Mate PCA      SSN RC MULT SRM MRC GRP NAME SSO
255-001-002                253 10 SHR *Y *Y grp01 ON
                255-001-004 254 10 SHR *Y *Y grp01 ON

MAPSET ID=7
PCA      Mate PCA      SSN RC MULT SRM MRC GRP NAME SSO
002-002-007                50 10 COM YES *Y grp01 OFF
                002-002-008 30 10 COM YES *Y grp01 OFF
                002-002-009 30 10 COM YES *Y grp01 OFF
                002-002-010 30 20 COM YES *Y grp01 OFF
                002-002-011 30 20 COM YES *Y grp01 OFF

MAPSET ID=8
PCI      Mate PCI      SSN RC MULT SRM MRC GRP NAME SSO
2-001-2                255 10 DOM NO YES grp03 OFF
                2-001-1                254 20 DOM NO YES grp03 OFF

MAPSET ID=9

```

```
PCN          Mate PCN      SSN RC MULT SRM MRC GRP NAME SSO
00347                253 10  SHR *N  *N  grp05  OFF
                01387      254 10  SHR *N  *N  grp05  OFF
```

```
MAP TABLE IS (25 of 36000) 1 % FULL
```

If any of the following items are not shown in the `rtrv-map` output, then the feature corresponding to these items is not enabled, or turned on if required.

- The `MAPSET` field - the Flexible GTT Load Sharing feature is not enabled.
- The `MRNSET` and `MRNPC` fields - the GTT Load Sharing with Alternate Routing Indicator feature is not enabled.
- The `WT`, `%WT`, `THR` columns - the Weighted GTT Load Sharing feature is not enabled and turned on.

If the maximum number of mated applications shown in the `rtrv-map` output in [1](#) is 1024, 2000, or 3000, continue the procedure with [3](#).

2. If the maximum number of mated applications shown in the `rtrv-map` output in [1](#) is 36000, the Flexible GTT Load Sharing feature is enabled.

Although the `rtrv-map` output shows there can be 36000 entries, a maximum of 1024, 2000, or 3000 different point codes (depending on whether the XMAP Table Expansion feature is enabled for 2000 or 3000 mated applications) can be provisioned for mated applications. To verify the number of different point codes that can be provisioned for mated applications, enter the `rtrv-tbl-capacity` command. The following is an example of the possible output.

```
rlghncxa03w 07-05-28 21:15:37 GMT EAGLE5 37.0.0
```

```
MAP table is (3000 of 3000) 100% full
```

 **Note:**

The `rtrv-tbl-capacity` command output contains other fields that are not used by this procedure. If you wish to see all the fields displayed by the `rtrv-tbl-capacity` command, see the `rtrv-tbl-capacity` command description in *Commands User's Guide*.

3. Continue the procedure by performing one of these steps.
 - If the `rtrv-map` output in [1](#) or the `rtrv-tbl-capacity` output in [2](#) shows that the maximum number of mated applications is 3000, and the current number of provisioned mated applications is 3000, no new point codes can be used to provision mated applications. Continue the procedure with [4](#).
 - If the `rtrv-map` output in [1](#) or the `rtrv-tbl-capacity` output in [2](#) shows that the maximum number of mated applications is either 1024 or 2000, and the mated application being added increases the number beyond 1024 or 2000, perform [Enabling the XMAP Table Expansion Feature](#) to enable a greater quantity of mated applications. After the quantity of mated applications has been increased, continue the procedure with [4](#). If the maximum number

of mated applications is not increased, no new point codes can be used to provision mated applications.

- If the `rtrv-map` output in 1 or the `rtrv-tbl-capacity` output in 2 shows that the maximum number of mated applications is either 1024, 2000, or 3000 and the mated application being added will not increase the number beyond the quantity shown in the `rtrv-map` output in 1 or the `rtrv-tbl-capacity` output in 2, continue the procedure with 4.
4. A MAP group, without the Flexible GTT Load Sharing feature enabled, a MAP set, other than the default MAP set, and a MAP group contained in the default MAP set can contain a maximum of 32 entries.

Verify the number of entries that the MAP group or MAP set contains by entering the `rtrv-map` command with the primary point code and SSN assigned to the MAP group or MAP set. If the Flexible GTT Load Sharing feature is enabled, the `mapset` parameter and MAP set ID of the MAP set that the new mated application will be added to.

If the specified MAP set is not the default MAP set, only the `mapset` parameter needs to be specified with the `rtrv-map` command. The point code and SSN does not need to be specified. For this example, enter one of these commands.

```
rtrv-map:pca=002-002-007:ssn=50
```

The following is an example of the possible output.

```
rlghncxa03w 09-07-07 00:34:31 GMT EAGLE5 41.1.0
```

PCA	Mate PCA	SSN	RC	MULT	SRM	MRC	GRP	NAME	SSO
002-002-007		50	10	COM	YES	*Y	grp01		OFF
	002-002-008	30	10	COM	YES	*Y	grp01		OFF
	002-002-009	30	10	COM	YES	*Y	grp01		OFF
	002-002-010	30	20	COM	YES	*Y	grp01		OFF
	002-002-011	30	20	COM	YES	*Y	grp01		OFF

```
MAP TABLE IS (25 of 1024) 2 % FULL
```

```
rtrv-map:pca=002-002-007:ssn=50:mapset=df1t
```

The following is an example of the possible output.

```
rlghncxa03w 09-07-07 00:34:31 GMT EAGLE5 41.1.0
```

```
MAPSET ID=DFLT
```

PCA	Mate PCA	SSN	RC	MULT	SRM	MRC	GRP	NAME	SSO
002-002-007		50	10	COM	YES	*Y	grp01		OFF
	002-002-008	30	10	COM	YES	*Y	grp01		OFF
	002-002-009	30	10	COM	YES	*Y	grp01		OFF
	002-002-010	30	20	COM	YES	*Y	grp01		OFF
	002-002-011	30	20	COM	YES	*Y	grp01		OFF

```
MAP TABLE IS (25 of 36000) 1 % FULL
```

```
rtrv-map:mapset=7
```

The following is an example of the possible output.

```
rlghncxa03w 09-07-07 00:34:31 GMT EAGLE5 41.1.0
```

```
MAPSET ID=7
PCA      Mate PCA      SSN RC MULT SRM MRC GRP NAME SSO
002-002-007      50 10 COM YES *Y grp01 OFF
              002-002-008 30 10 COM YES *Y grp01 OFF
              002-002-009 30 10 COM YES *Y grp01 OFF
              002-002-010 30 20 COM YES *Y grp01 OFF
              002-002-011 30 20 COM YES *Y grp01 OFF
```

```
MAP TABLE IS (25 of 36000) 1 % FULL
```

If the MAP group or MAP set contains 32 entries, no more entries can be added to the specified MAP group or MAP set. One of these actions can be performed.

- Entries can be added another MAP group or MAP set. Repeat this step for the other MAP group or MAP set.
- Entries can be removed from the specified MAP group or MAP set. To remove entries from the specified MAP group or MAP set, perform [Removing a Mated Application](#).
- Entries can be added to a new MAP group or MAP set.

 **Note:**

If none of these actions will be performed, then this procedure cannot be performed.

If the MAP group or MAP set contains less than 32 entries, entries can be added to the MAP group or MAP set.

After it has been determined which MAP group or MAP set that the new entries will be added to (a new MAP group or MAP set or an existing MAP group or MAP set), continue the procedure by performing one of these steps.

- If an existing point code is being added to this MAP group or MAP set, continue the procedure with [5](#).
 - If a new point code is being added to this MAP group or MAP set, continue the procedure by performing one of these steps.
 - If a concerned signaling point code (CSPC) group is not being assigned to the mated application, continue the procedure with [8](#). If the mated point code is not assigned to a CSPC group, that point code will not be notified of the subsystem's status.
 - If a concerned signaling point code (CSPC) group will be assigned to the mated application, continue the procedure with [6](#).
5. A mated application can be provisioned with a point code that is assigned to other mated applications as long as the SSN is not assigned to other mated applications.

A point code can be assigned to maximum of 12 different SSNs. Verify the number of SSNs assigned to the point code that will be specified for the mated application

in this procedure by entering the `rtrv-map` command with the point code of the new mated application. For this example, enter this command.

```
rtrv-map:pca=255-001-000
```

This is an example of the possible output.

```
rlghncxa03w 09-07-07 00:34:31 GMT EAGLE5 41.1.0

PCA          Mate PCA          SSN RC  MULT SRM  MRC  GRP  NAME  SSO
255-001-000          250 10  SOL  *Y   *Y   grp01  ON

255-001-000          251 10  SHR  *Y   *Y   grp01  OFF
                253-001-002 254 10  SHR  *Y   *Y   grp01  OFF

255-001-000          252 10  SOL  *Y   *Y   grp01  ON

255-001-000          253 10  SHR  *Y   *Y   grp01  OFF
                253-001-004 254 10  SHR  *Y   *Y   grp01  OFF

MAP TABLE IS (25 of 1024) 2 % FULL
```

If the Flexible GTT Load Sharing feature is enabled, the MAPSET IDs for the mated applications are shown in the `rtrv-map` output.

If the Weighted GTT Load Sharing feature is enabled and turned on, the `WT`, `%WT`, and `THR` columns are shown in the `rtrv-map` output.

If the point code is assigned to 12 different SSNs, and neither an existing point code in the `rtrv-map` output nor a new point code will be used to provision the mated application, then this procedure cannot be performed.

If the point code is assigned to less than 12 different SSNs, then the existing point code in the `rtrv-map` output can be used to provision the mated application.

If the point code is assigned to 12 different SSNs, another existing point code in the `rtrv-map` output or a new point code must be used to provision the mated application. If an existing point code in the `rtrv-map` output will be used to provision the mated application, repeat this step for that point code.

After it has been determined which point code will be used to provision the mated application (a new point code or an existing point code), continue the procedure by performing one of these steps.

- If a concerned signaling point code (CSPC) group is not being assigned to the mated application, continue the procedure with 8. If the mated point code is not assigned to a CSPC group, that point code will not be notified of the subsystem's status.
 - If a concerned signaling point code (CSPC) group will be assigned to the mated application, continue the procedure with 6.
6. Display the point codes in the CSPC group that you wish to assign to the mated application by first entering the `rtrv-cspc` command with no parameters.

This is an example of the possible output.

```
rlghncxa03w 07-05-25 09:48:31 GMT EAGLE5 37.0.0
CSPC GRP NETWORK PERCENT FULL
```

grp01	ANSI	6%
grp02	ITU-I	9%
grp03	ITU-N	12%
grp04	ANSI	15%
grp05	ANSI	15%
grp10	ANSI	15%
grp15	ANSI	15%

If the desired CSPC group is shown in the `rtrv-cspc` output, re-enter the `rtrv-cspc` command with the CSPC group name. For this example, enter these commands.

```
rtrv-cspc:grp=grp05
```

This is an example of the possible output.

```
rlghncxa03w 07-05-25 09:48:31 GMT EAGLE5 37.0.0
CSPC GRP      PCA
grp05         005-005-005
              007-007-007
              008-008-008
              009-009-009
```

```
rtrv-cspc:grp=grp10
```

This is an example of the possible output.

```
rlghncxa03w 07-05-25 09:59:31 GMT EAGLE5 37.0.0
CSPC GRP      PCA
grp10         003-003-003
              004-004-004
              008-008-008
              009-009-009
```

```
rtrv-cspc:grp=grp15
```

This is an example of the possible output.

```
rlghncxa03w 07-05-25 09:48:31 GMT EAGLE5 37.0.0
CSPC GRP      PCA
grp15         005-005-005
              006-006-006
              008-008-008
              009-009-009
```

 **Note:**

If the ANSI/ITU SCCP Conversion feature is enabled, then point codes of multiple network types can be displayed in the `rtrv-cspc` output, if point codes of multiple network types are assigned to the CSPC group.

If the CSPC group is not in the database, or if the required point code is not assigned to the CSPC group, perform the [Adding a Concerned Signaling Point Code](#) procedure to add the required CSPC group or point code to the database.

 **Note:**

If the output of the `rtrv-cspc` command performed in 6 shows CSPC groups containing a mixture of point code types, or if the new CSPC group that was added in 6 contains a mixture of point code types, continue the procedure with 8.

7. The format of the point codes in the CSPC group specified with the `grp` parameter must be the same as the primary point code specified with the `ent-map` command only if the ANSI/ITU SCCP Conversion feature is not enabled.

If the ANSI/ITU SCCP Conversion feature is enabled, the CSPC group may contain a mixture of point code types (refer to the [Adding a Concerned Signaling Point Code](#) procedure), and the network type of the CSPC group can be different from the network type of the primary point code of the mated application.

Verify the status of the ANSI/ITU SCCP Conversion feature by entering this command.

```
rtrv-ctrl-feat:partnum=893012001
```

The following is an example of the possible output.

```
rlghncxa03w 07-05-28 21:15:37 GMT EAGLE5 37.0.0
```

The following features have been permanently enabled:

Feature Name	Partnum	Status	Quantity
SCCP Conversion	893012001	on	----

The following features have been temporarily enabled:

Feature Name	Partnum	Status	Quantity	Trial
Period Left				
Zero entries found.				

The following features have expired temporary keys:

Feature Name	Partnum
Zero entries found.	

If the ANSI/ITU SCCP Conversion feature is not enabled, perform the [Activating the ANSI/ITU SCCP Conversion Feature](#) procedure to enable the ANSI/ITU SCCP Conversion feature.

8. If the `MAPSET` column is shown in the `rtrv-map` output in 1, the Flexible GTT Load Sharing feature is enabled. Continue the procedure with 9.

If the `MAPSET` column is not shown in 1 and you do not wish to provision MAP sets in this procedure, continue the procedure with 9.

If the `MAPSET` column is not shown in 1 and you wish to provision MAP sets in this procedure, perform the [Activating the Flexible GTT Load Sharing Feature](#)

procedure to enable the Flexible GTT Load Sharing feature. After the Flexible GTT Load Sharing feature is enabled, continue the procedure with [9](#).

 **Note:**

If the `esso` parameter will be specified for the mated application, continue the procedure with [10](#). The EAGLE's point code and LNP, EIR, V-Flex, ATINPQ, or INP subsystem cannot be assigned to a mated application using the `esso` parameter.

9. Display the EAGLE self-identification, using the `rtrv-sid` command.

```
rlghncxa03w 07-05-10 11:43:04 GMT EAGLE5 37.0.0
      PCA          PCI          PCN
CLLI          PCTYPE
      010-020-030      1-023-1      12-0-14-1
rlghncxa03w          OTHER
          s-1-023-1      s-12-0-14-1

      CPCA
001-001-001      002-002-003      002-002-004      002-002-005
002-002-006      002-002-007      002-002-008      002-002-009
004-002-001      004-003-003      050-060-070

      CPCI
1-001-1          1-001-2          1-001-3          1-001-4
1-002-1          1-002-2          1-002-3          1-002-4
2-001-1          7-222-7

      CPCN
2-0-10-3          2-0-11-0          2-0-11-2          2-0-12-1
2-2-3-3          2-2-4-0          10-14-10-1
```

The EAGLE's true point code is shown in either the `PCA`, `PCI`, `PCN`, or `PCN24` fields. This is an example of the possible output.

If the both point codes that will be specified for the mated application are point codes assigned to other mated applications, continue the procedure by performing one of these steps.

- If the `mrnset` and `mrnpc` parameters will be specified for the mated application, continue the procedure with [15](#).
- If the `mrnset` and `mrnpc` parameters will not be specified for the mated application, continue the procedure by performing one of these steps.
 - If a new mated application is being added, continue the procedure with [16](#).
 - If an entry is being added to an existing mated application, continue the procedure with [17](#).

If the EAGLE's point code will be specified for the mated application, and its mated point code is assigned to other mated applications, continue the procedure with [13](#).

If only one of the point codes that will be specified for the mated application is assigned to other mated applications, perform 10 for the new point code that is not assigned to other mated applications.

10. Display the destination point codes in the database by entering the `rtrv-dstn` command. This is an example of the possible output.

```
rlghncxa03w 10-12-10 11:43:04 GMT EAGLE5 43.0.0
Extended Processing Time may be Required
```

DPCA ALIASN/N24	CLLI DMN	BEI	ELEI	ALIASI
001-207-000	----- SS7	no	---	-----
001-001-001	----- SS7	no	---	-----
001-001-002	----- SS7	no	---	-----
001-005-000	----- SS7	no	---	-----
001-007-000	----- SS7	no	---	-----
008-012-003	----- SS7	no	---	-----
003-002-004	----- SS7	no	---	-----
009-002-003	----- SS7	no	---	-----
010-020-005	----- SS7	no	---	-----

DPCI ALIASN/N24	CLLI DMN	BEI	ELEI	ALIASA
1-207-0	----- SS7	no	---	-----
0-015-0	----- SS7	no	---	-----
0-017-0	----- SS7	no	---	-----
1-011-1	----- SS7	no	---	-----
1-011-2	----- SS7	no	---	-----

```
Destination table is (14 of 2000) 1% full
Alias table is (0 of 12000) 0% full
PPC table is (1 of 20) 5% full
```

If the required point code is not shown in the `rtrv-dstn` output, perform the "Adding a Destination Point Code" procedure in *Database Administration - SS7 User's Guide* to add the required point code. A proxy point code cannot be assigned to the point code.

After the new point code has been added, skip 11 through 14 and perform one of the Adding a Route procedures in *Database Administration - SS7 User's Guide* and add the required route to the database. After the route has been added, continue the procedure by performing one of these steps.

- If the `mrnset` and `mrnpc` parameters will be specified for the mated application, continue the procedure with 15.
- If the `mrnset` and `mrnpc` parameters will not be specified for the mated application, continue the procedure by performing one of these steps.
 - If a new mated application is being added, continue the procedure with 16.
 - If an entry is being added to an existing mated application, continue the procedure with 17.

11. Display the point code that will be assigned to the mated application by using the `rtrv-dstn` command and specifying the point code. For this example, enter this command.

```
rtrv-dstn:dpca=010-020-005
```

This is an example of the possible output.

```
rlghncxa03w 10-12-10 11:43:04 GMT EAGLE5 43.0.0
```

DPCA	CLLI	BEI	ELEI	ALIASI
ALIASN/N24	DMN			
010-020-005	-----	no	---	-----
-----	SS7			

PPCA	NCAI	PRX	RCAUSE	NPRST	SPLITIAM	HMSMSC	HMSCP
SCCPMSGCNV							
009-002-003	----	no	50	on	20	no	no none

```
Destination table is (14 of 2000) 1% full
Alias table is (0 of 12000) 0% full
PPC table is (1 of 20) 5% full
```

If the point code is not shown in the `rtrv-dstn` command output, the following output is displayed.

```
rlghncxa03w 09-05-10 11:43:04 GMT EAGLE5 41.0.0
```

```
No destinations meeting the requested criteria were found
```

```
Destination table is (14 of 2000) 1% full
Alias table is (0 of 12000) 0% full
PPC table is (1 of 20) 5% full
```

A proxy point code (a point code value is shown in the `PPC` column) cannot be assigned to the point code. If a proxy point code is shown in this step, choose another point code from the `rtrv-dstn` output in the previous step and repeat this step.

If the point code is not shown in the `rtrv-dstn` output, perform the “Adding a Destination Point Code” procedure in *Database Administration - SS7 User's Guide* and add the point code to the destination point code table.

After the new point code has been added, skip 12 through 14 and perform one of the Adding a Route procedures in *Database Administration - SS7 User's Guide* and add the required route to the database. After the route has been added, continue the procedure by performing one of these steps.

- If the `mrnset` and `mrnpc` parameters will be specified for the mated application, continue the procedure with 15.
- If the `mrnset` and `mrnpc` parameters will not be specified for the mated application, continue the procedure by performing one of these steps.
 - If a new mated application is being added, continue the procedure with 16.
 - If an entry is being added to an existing mated application, continue the procedure with 17.

12. Enter the `rtrv-rte` command with the `dpc` parameter specifying the point codes to be used with the `ent-map` or `chg-map` commands to verify whether or not the point code is the DPC of a route.

For this example, enter these commands.

```
rtrv-rte:dPCA=003-003-003
```

This is an example of the possible output.

```
rlghncxa03w 07-05-07 11:43:04 GMT EAGLE5 37.0.0
  DPCA          ALIASI      ALIASN/N24    LSN          RC    APCA
  003-003-003  -----  -----      ls03         10
003-003-003
                                           RTX:No  CLLI=ls07clli
```

```
rtrv-rte:dPCA=005-005-005
```

This is an example of the possible output.

```
rlghncxa03w 07-05-07 11:43:04 GMT EAGLE5 37.0.0
  DPCA          ALIASI      ALIASN/N24    LSN          RC    APCA
  005-005-005  -----  -----      ls05         10
005-005-005
                                           ls15         30
089-047-123
                                           lsa8         50
077-056-000
                                           RTX:No  CLLI=ls05clli
```

```
rtrv-rte:dPCA=008-008-008
```

This is an example of the possible output.

```
rlghncxa03w 07-05-07 11:43:04 GMT EAGLE5 37.0.0
  DPCA          ALIASI      ALIASN/N24    LSN          RC    APCA
  008-008-008  -----  -----      ls20         10
```

008-008-008

RTX:No CLLI=ls20clli

rtrv-rte:dpca=031-049-100

This is an example of the possible output.

```
rlghncxa03w 07-05-07 11:43:04 GMT EAGLE5 37.0.0
  DPCA          ALIASI      ALIASN/N24   LSN          RC      APCA
  031-049-100  -----  -----  ls10         10
031-049-100
```

RTX:No CLLI=ls10clli

rtrv-rte:dpca=040-040-040

This is an example of the possible output.

```
rlghncxa03w 07-05-07 11:43:04 GMT EAGLE5 37.0.0
  DPCA          ALIASI      ALIASN/N24   LSN          RC      APCA
  040-040-040  -----  -----  ls11         10
040-040-040
```

RTX:No CLLI=ls11clli

rtrv-rte:dpca=056-113-200

This is an example of the possible output.

```
rlghncxa03w 07-05-07 11:43:04 GMT EAGLE5 37.0.0
  DPCA          ALIASI      ALIASN/N24   LSN          RC      APCA
  056-113-200  -----  -----  ls12         10
056-113-200
```

RTX:No CLLI=ls12clli

rtrv-rte:dpca=060-060-060

This is an example of the possible output.

```
rlghncxa03w 07-05-07 11:43:04 GMT EAGLE5 37.0.0
  DPCA          ALIASI      ALIASN/N24   LSN          RC      APCA
  060-060-060  -----  -----  ls13         10
060-060-060
```

RTX:No CLLI=ls13clli

rtrv-rte:dpca=070-070-070

This is an example of the possible output.

```
rlghncxa03w 07-05-07 11:43:04 GMT EAGLE5 37.0.0
  DPCA          ALIASI      ALIASN/N24   LSN          RC      APCA
  070-070-070  -----  -----  ls15         10
070-070-070
```

RTX:No CLLI=ls15clli

```
rtrv-rte:dpca=179-183-050
```

This is an example of the possible output.

```
rlghncxa03w 07-05-07 11:43:04 GMT EAGLE5 37.0.0
  DPCA          ALIASI      ALIASN/N24    LSN          RC      APCA
  179-183-050  -----  -----      ls18        10
179-183-050
                                           RTX:No  CLLI=ls18clli
```

If the point code is not shown in the `rtrv-rte` output, perform one of the Adding a Route procedures in *Database Administration - SS7 User's Guide* and add the required route to the database.

If the EAGLE's point code will not be specified for the mated application, continue the procedure by performing one of these steps.

- If the `mrnset` and `mrnpc` parameters will be specified for the mated application, continue the procedure with [15](#).
- If the `mrnset` and `mrnpc` parameters will not be specified for the mated application, continue the procedure by performing one of these steps.
 - If a new mated application is being added, continue the procedure with [16](#).
 - If an entry is being added to an existing mated application, continue the procedure with [17](#).

If the EAGLE's point code will be specified for the mated application, continue the procedure with [13](#).

13. Verify whether or not either the LNP, ATINPQ, or ANSI41 AIQ feature is enabled, or the EIR, INP, V-Flex, or ANSI-41 INP Query feature is enabled and turned on by entering the `rtrv-ctrl-feat` command.

This list shows the entries that are displayed in the `rtrv-ctrl-feat` output for the features that are enabled, and turned on if required.

- LNP TNS with a quantity greater than zero - the LNP feature is enabled.
- EIR with the status `on` - the EIR feature is enabled and turned on.
- VFLEX with the status `on` - the V-Flex feature is enabled and turned on.
- ATINP - the ATINP feature is enabled
- INP with the status `on` - the INP feature is enabled and turned on
- ANSI-41 INP Query with the status `on` - the ANSI-41 INP Query feature is enabled and turned on.
- ANSI41 AIQ - the ANSI41 AIQ feature is enabled.

Continue the procedure by performing one of these steps.

- If the LNP, ATINPQ, or ANSI41 AIQ feature is enabled, or if the EIR, INP, V-Flex, or ANSI-41 INP Query feature is enabled and turned on, continue the procedure with [16](#).
- If the LNP, ATINPQ, or ANSI41 AIQ feature is not enabled, or if the EIR, INP, V-Flex, or ANSI-41 INP Query feature is not enabled or turned on, continue the procedure with [14](#).

14. Enable either the INP, ANSI-41 INP Query, EIR, V-Flex, ATINPQ, ANSI41 AIQ, or LNP features, depending on which subsystem you wish to use.

To use the INP subsystem, enable and turn on either the INP or ANSI-41 INP Query feature by performing the procedures in *INP/AINPQ User's Guide*.

To use the LNP subsystem, enable the LNP feature by performing the procedures in *ELAP Administration and LNP Feature Activation User's Guide*.

To use the EIR subsystem, enable and turn on the EIR feature by performing the procedures in *EIR User's Guide*.

To use the V-Flex subsystem, enable and turn on the V-Flex feature, perform the procedures in *V-Flex User's Guide*.

To use the ATINPQ subsystem, enable the ATINP feature, perform the procedures in *ATINP User's Guide*.

To use the AIQ subsystem, enable the ANSI AIQ feature, perform the procedures in *Analyzed Information Features User's Guide*.

 **Note:**

If the LNP feature is enabled, the INP, ANSI-41 INP Query, V-Flex, ATINPQ, or EIR features cannot be enabled.

15. The MRN point code value must be assigned to an MRN set. The MRN set must be shown in the `rtrv-mrn` output. Display the MRN sets by entering the `rtrv-mrn` command. This is an example of the possible output.

```
rlghncxa03w 09-02-07 00:34:31 GMT EAGLE5 40.1.0
```

MRNSET	MAPSET	MAPPC	MAPSSN	PC	RC	WT
%WT	THR					
DFLT	7	002-002-007	50	005-005-005	10	10
14	1			006-001-001	10	10
14	1			006-001-002	10	20
28	1			006-001-003	10	30
42	1			006-001-004	20	40
23	1			006-001-005	20	40
23	1			006-001-006	20	40
23	1			006-001-007	20	50
29	1					
MRNSET	MAPSET	MAPPC	MAPSSN	PC	RC	WT
%WT	THR					
1	-----	-----	---	007-007-007	10	10
14	1			008-001-001	10	10

14	1		008-001-002	10	20
28	1		008-001-003	10	30
42	1		008-001-004	20	40
23	1		008-001-005	20	40
23	1		008-001-006	20	40
23	1		008-001-007	20	50
29	1				

MRN table is (16 of 5990) 1% full

If any of the following items are not shown in the `rtrv-mrn` output, then the feature corresponding to these items is not enabled, or turned on if required.

- The `MRNSET` field - the Flexible GTT Load Sharing feature is not enabled.
- The `MAPSET`, `MAPPC` and `MAPSSN` fields - the GTT Load Sharing with Alternate Routing Indicator feature is not enabled.
- The `WT`, `%WT`, `THR` columns - the Weighted GTT Load Sharing feature is not enabled and turned on.

 **Note:**

The network type of the `pc/pca/pci/pcn/pcn24` and `mrnpc/mrnpc/mrnpci/mrnpcn/mrnpcn24` parameter values must be compatible, as shown in [Table 2-41](#)

If the MRN set that you wish to use, containing the desired point code, is not shown in the `rtrv-mrn` output, add the required MRN set by performing the [Provisioning MRN Entries](#) procedure.

If the MRN set that you wish to use is shown in the `rtrv-mrn` output, or [Provisioning MRN Entries](#) was performed in this step, continue the procedure by performing one of these steps.

- If a new mated application is being added, continue the procedure with [16](#).
 - If an entry is being added to an existing mated application, continue the procedure with [17](#).
- 16.** Add the mated application to the database using the `ent-map` command. Use [Table 2-43](#) as a guide for the parameters and values that can be specified with the `ent-map` command.

Table 2-43 Dominant Mated Application Parameter Combinations for the ENT-MAP Command

Other Subsystems	LNP Subsystem	INP Subsystem	EIR Subsystem
Mandatory Parameters			

Table 2-43 (Cont.) Dominant Mated Application Parameter Combinations for the ENT-MAP Command

Other Subsystems	LNP Subsystem	INP Subsystem	EIR Subsystem
:pc/pca/pci/pcn/ pcn24 (See Notes 1, 11, and 14)	:pc/pca (See Note 2)	:pcn/pcn24 (See Note 3)	:pci/pcn/pcn24 (See Note 4)
:ssn= <subsystem number, 2 - 255>	:ssn=<LNP subsystem number, 2 - 255>	:ssn=<INP subsystem number, 2 - 255>	:ssn=<EIR subsystem number, 2 - 255>
:rc=<0 - 99> (See Note 7)	:rc=<0 - 99> (See Note 7)	:rc=<0 - 99> (See Note 7)	:rc=<0 - 99> (See Note 7)
:mpc/mpca/mpci/ mpcn/mpcn24 (See Notes 1, 9, 11, and 14)	:mpc/mpca (See Note 2)	:mpcn/mpcn24 (See Notes 3 and 11)	:mpci/mpcn/mpcn24 (See Notes 4 and 11)
:mssn= <subsystem number of the mate, 2 - 255>	:mssn= <subsystem number of the mate, 2 - 255>	:mssn= <subsystem number of the mate, 2 - 255>	:mssn= <subsystem number of the mate, 2 - 255>
:materc=<0 - 99> (See Note 7)	:materc=<0 - 99> (See Note 7)	:materc=<0 - 99> (See Note 7)	:materc=<0 - 99> (See Note 7)
Optional Parameters			
:grp=<CSPC group name> (See Note 8)	:grp=<CSPC group name> (See Note 8)	:grp=<CSPC group name> (See Note 8)	:grp=<CSPC group name> (See Note 8)
:mrc=<yes, no> (See Note 12)	:mrc=<yes, no> (See Note 12)	:mrc=<yes, no> (See Note 12)	:mrc=<yes, no> (See Note 12)
:mapset=<new, dflt> (See Note 10)	:mapset=dflt (See Note 10)	:mapset=dflt (See Note 10)	:mapset=dflt (See Note 10)
:srm=<yes, no> (See Note 12)	:srm=<yes, no> (See Note 12)		
:sso=<on, off>			
:mrnset = <MRN set ID from the <code>trv- mrn</code> output> (See Note 13)			
:mrnpc/mrnpca/ mrnpci/mrnpai/ mrnpcn24=<the point code value in the MRN set> (See Notes 13 and 14)			
V-FLEX Subsystem	ATINPQ Subsystem	AIQ Subsystem	
Mandatory Parameters			
:pc/pca/pci/pcn/pcn24 (See Note 5)	:pc/pca/pci/pcn (See Note 6)	:pc/pca/pci/pcn/pcn24 (See Note 15)	
:ssn=<V-Flex subsystem number, 2 - 255>	:ssn=<V-Flex subsystem number, 2 - 255>	:ssn=<V-Flex subsystem number, 2 - 255>	
:rc=<0 - 99> (See Note 7)	:rc=<0 - 99> (See Note 7)	:rc=<0 - 99> (See Note 7)	
:mpc/mpca/mpci/ mpcn/mpcn24 (See Notes 5 and 11)	:mpc/mpca/mpci/mpcn (See Notes 6 and 11)	:mpc/mpca/mpci/ mpcn/mpcn24 (See Notes 11 and 15)	

V-FLEX Subsystem	ATINPQ Subsystem	AIQ Subsystem
:mssn= <subsystem number of the mate, 2 - 255>	:mssn= <subsystem number of the mate, 2 - 255>	:mssn= <subsystem number of the mate, 2 - 255>
:materc=<0 - 99> (See Note 7)	:materc=<0 - 99> (See Note 7)	:materc=<0 - 99> (See Note 7)
Optional Parameters		
:grp=<CSPC group name> (See Note 8)	:grp=<CSPC group name> (See Note 8)	:grp=<CSPC group name> (See Note 8)
:mrc=<yes, no> (See Note 12)	:mrc=<yes, no> (See Note 12)	:mrc=<yes, no> (See Note 12)
:mapset=dflt (See Note 10)	:mapset=dflt (See Note 10)	:mapset=dflt (See Note 10)
:srm=<yes, no> (See Note 12)	:srm=<yes, no> (See Note 12)	:srm=<yes, no> (See Note 12)

V-FLEX Subsystem	ATINPQ Subsystem	AIQ Subsystem
Notes		
<p>a. The primary point code is an ANSI, ITU-I, ITU-I spare, ITU-N, ITU-N spare, or ITU-N24 from the <code>rtrv-rte</code> or <code>rtrv-map</code> outputs. The mate point code is an ANSI, ITU-I, ITU-I spare, ITU-N, ITU-N spare, or ITU-N24 point code from the <code>rtrv-rte</code> or <code>rtrv-map</code> outputs.</p> <p>b. The primary point code for the LNP subsystem is the ANSI point code from the <code>rtrv-sid</code> output. The mate point code is an ANSI point code from the <code>rtrv-rte</code> or <code>rtrv-map</code> outputs.</p> <p>c. The primary point code for the INP subsystem is the ITU-N, ITU-N spare, or ITU-N24 point code from the <code>rtrv-sid</code> output. The mate point code is an ITU-N, ITU-N spare, or ITU-N24 point code from the <code>rtrv-rte</code> or <code>rtrv-map</code> outputs.</p> <p>d. The primary point code for the EIR subsystem is the ITU-I, ITU-I spare, ITU-N, ITU-N spare, or ITU-N24 point code from the <code>rtrv-sid</code> output. The mate point code is an ITU-I, ITU-I spare, ITU-N, ITU-N spare, or ITU-N24 point code from the <code>rtrv-rte</code> or <code>rtrv-map</code> outputs.</p> <p>e. The primary point code for the V-Flex subsystem is the ANSI, ITU-I, ITU-I spare, ITU-N, ITU-N spare, or ITU-N24 point code from the <code>rtrv-sid</code> output. The mate point code is an ANSI, ITU-I, ITU-I spare, ITU-N, ITU-N spare, or ITU-N24 point code from the <code>rtrv-rte</code> or <code>rtrv-map</code> outputs.</p> <p>f. The primary point code for the ATINPQ subsystem is the ANSI, ITU-I, ITU-I spare, ITU-N, or ITU-N spare point code from the <code>rtrv-sid</code> output. The mate point code is an ANSI, ITU-I, ITU-I spare, ITU-N, or ITU-N spare point code from the <code>rtrv-rte</code> or <code>rtrv-map</code> outputs.</p> <p>g. The <code>materc</code> parameter value must be greater than the <code>rc</code> parameter value.</p> <p>h. The format of the point codes in the CSPC group specified with the <code>grp</code> parameter must be the same as the primary point code specified with the <code>ent-map</code> command only if the ANSI/ITU SCCP Conversion feature is not enabled. If the ANSI/ITU SCCP Conversion feature is enabled, the CSPC group may contain a mixture of point code types (refer to the Adding a Concerned Signaling Point Code procedure), and the network type of the CSPC group can be different from the network type of the primary point code of the mated application.</p> <p>i. For mated applications containing ANSI or 24-bit ITU-N point codes, or the EAGLE's true point code, the format of the point codes specified in the <code>ent-map</code> command must be the same. For example, if the primary point code is a 24-bit ITU-N point code (<code>pcn24</code>), the mate point code must be a 24-bit ITU-N point code (<code>mpcn24</code>). The mate point codes of mated applications containing either ITU-I, ITU-I spare, 14-bit ITU-N, or 14-bit ITU-N spare primary point codes do not have to be the same format as the primary point code. The mate point codes of these mated applications can be a mixture of ITU-I, ITU-I spare, 14-bit ITU-N, or 14-bit ITU-N spare point codes.</p> <p>j. If the Flexible GTT Load Sharing is enabled, the <code>mapset</code> parameter must be specified with the <code>ent-map</code> command. If the Flexible GTT Load Sharing is not enabled, the <code>mapset</code> parameter cannot be specified with the <code>ent-map</code> command.</p> <p>To provision entries in the default MAP set, the <code>mapset=default</code> parameter must be specified with the <code>ent-map</code> command.</p> <p>To provision entries in a new MAP set, the <code>mapset=new</code> parameter must be specified with the <code>ent-map</code> command. The <code>mapset=new</code> parameter can be specified only with the <code>ent-map</code> command. When the <code>ent-map</code> command is</p>		

V-FLEX Subsystem	ATINPQ Subsystem	AIQ Subsystem
<p>executed with the <code>mapset=new</code> parameter, the new MAP set ID is automatically generated and displayed in the output of the <code>ent-map</code> command as follows.</p> <p>New MAPSET Created : MAPSETID = <new MAP set ID></p> <p>A MAP set, other than the default MAP set, is a MAP group provisioned with the MAP set ID and can contain a maximum of 32 point code and subsystem entries.</p> <p>The default MAP set can contain multiple MAP groups. Each group in the default MAP set can contain a maximum of 32 point code and subsystem entries.</p> <p>The point code and subsystem entry can appear only once in the default MAP set, so the point code and subsystem entry can appear in only one MAP group in the default MAP set.</p> <p>The point code and subsystem entry provisioned in a MAP set can be provisioned in multiple MAP sets. If a point code and subsystem entry is provisioned in different MAP sets, the relative cost value of the entry in each MAP set can be different. All the point code and subsystem entries in a MAP set, including the default MAP set, must be different.</p> <p>k. If the point code selected from either the <code>rtrv-rte</code> or <code>rtrv-map</code> outputs is a 14-bit ITU-N point code, then the <code>pcn/mpcn</code> parameters must be specified. If the point code selected from either the <code>rtrv-rte</code> or <code>rtrv-map</code> outputs is a 24-bit ITU-N point code, then the <code>pcn24/mpcn24</code> parameters must be specified.</p> <p>l. The <code>srm=yes</code> parameter can be specified only for mated applications containing ANSI point codes. These are the default values for the <code>srm</code> and <code>mrc</code> parameters.</p> <ul style="list-style-type: none"> • ANSI mated applications - <code>srm=yes, mrc=yes</code> • ITU mated applications - <code>srm=no, mrc=no</code> <p>m. The <code>mrnset</code> and <code>mrnpc/mrnpca/mrnpai/mrnpai/mrnpai/mrnpai/mrnpai</code> parameters can be specified only if the GTT Load Sharing with Alternate Routing Indicator feature is enabled. Refer to the Activating the GTT Load Sharing with Alternate Routing Indicator Feature procedure for information about enabling the GTT Load Sharing with Alternate Routing Indicator feature. The <code>mrnset</code> and <code>mrnpc/mrnpca/mrnpai/mrnpai/mrnpai/mrnpai</code> values must be shown in the <code>rtrv-mrn</code> output.</p> <p>n. The network type of the <code>pc/pca/pci/pcn/pcn24</code> and <code>mrnpc/mrnpca/mrnpai/mrnpai/mrnpai/mrnpai</code> parameter values must be compatible, as shown in Table 2-41.</p> <p>o. The primary point code for the AIQ subsystem is the ANSI, ITU-I, ITU-I spare, ITU-N, ITU-N spare, or ITU-N24 point code from the <code>rtrv-sid</code> output. The mate point code is an ANSI, ITU-I, ITU-I spare, ITU-N, ITU-N spare, or ITU-N24 point code from the <code>rtrv-rte</code> or <code>rtrv-map</code> outputs.</p>		

If the Flexible GTT Load Sharing feature is not enabled for this example, enter these commands.

```
ent-
map:pca=003-003-003:ssn=254:rc=10:mpc=040-040-040:mssn=254 :m
aterc=20:grp=grp10:mrc=yes:srm=yes:sso=on
```

```
ent-
map:pca=005-005-005:ssn=250:rc=10:mpc=060-060-060:mssn=250 :m
aterc=20:grp=grp15:mrc=yes:srm=yes:sso=off
```



```
ent-
map:pci=5-005-5:ssn=50:rc=10:mpcn=0257:mssn=50:materc=20 :grp
=grp20:mrc=yes:sso=off
```

When each of these commands have successfully completed, this message should appear.

```
rlghncxa03w 07-05-07 11:44:13 GMT EAGLE5 37.0.0
ENT-MAP: MASP A - COMPLTD
```

If the Flexible GTT Load Sharing feature is enabled for this example, enter these commands.

```
ent-
map:pca=003-003-003:ssn=254:rc=10:mpc=040-040-040:mssn=254 :m
aterc=20:grp=grp10:mrc=yes:srm=yes:sso=on:mapset=new
```

```
ent-
map:pca=005-005-005:ssn=250:rc=10:mpc=060-060-060:mssn=250 :m
aterc=20:grp=grp15:mrc=yes:srm=yes:sso=off:mapset=df1t
```

```
ent-
map:pci=5-005-5:ssn=50:rc=10:mpcn=0257:mssn=50:materc=20 :grp
=grp20:mrc=yes:sso=off:mapset=new
```

If the GTT Load Sharing with Alternate Routing Indicator feature is enabled for this example, enter these commands.

```
ent-
map:pca=003-003-003:ssn=254:rc=10:mpc=040-040-040:mssn=254 :m
aterc=20:grp=grp10:mrc=yes:srm=yes:sso=on:mapset=new:mrnset=d
flt :mrnpc= 005-005-005
```

```
ent-
map:pca=005-005-005:ssn=250:rc=10:mpc=060-060-060:mssn=250 :m
aterc=20:grp=grp15:mrc=yes:srm=yes:sso=off:mapset=df1t:mrnset
=1 :mrnpc= 007-007-007
```

If the Flexible GTT Load Sharing feature is enabled when each of these commands have successfully completed, and a new MAP set was created, a message similar to the following should appear.

```
rlghncxa03w 07-05-07 11:44:13 GMT EAGLE5 37.0.0
New MAPSET Created : MAPSETID = 9
ENT-MAP: MASP A - COMPLTD
```

If the Flexible GTT Load Sharing feature is enabled when each of these commands have successfully completed, and the mated application was added to the default MAP set, this message should appear.

```
rlghncxa03w 07-05-07 11:44:13 GMT EAGLE5 37.0.0
ENT-MAP: MASP A - COMPLTD
```

If no other entries are being added to the mated application, or if the EAGLE's true point code was specified for the mated application, continue the procedure with [18](#).

If other entries are being added to the mated application, continue the procedure with 17.

17. Add the mated point code and subsystem to the mated application using the `chg-map` command. Use Table 2-44 as a guide for the parameters and values that can be specified with the `chg-map` command.

Table 2-44 Dominant Mated Application Parameter Combinations for the CHG-MAP Command

Mandatory Parameters

`:pc/pca/pci/pcn/pcn24`=<ANSI, ITU-I, ITU-I spare, ITU-N, ITU-N spare, or ITU-N24 primary point code that the mate point code will be assigned to> (See Notes 4 and 8)

`:ssn`=<subsystem number assigned to the primary point code>

`:mpc/mpca/mpci/mpcn/mpcn24`=<ANSI, ITU-I, ITU-I spare, ITU-N, ITU-N spare, or ITU-N24 point code of the mate from the `rtrv-rte` or `rtrv-map` outputs> (See Notes 2, 4, and 8)

`:mssn`=<subsystem number of the mate, 2 - 255>

`:materc`=<0 - 99> The `materc` parameter value must be greater than the `terc` parameter value.

Optional Parameters

`:grp`=<CSPC group name> (See Notes 1 and 6)

`:sso`=<on, off> (See Note 6)

`:srm`=<yes, no> (See Notes 5 and 6)

`:mrc`=<yes, no> (See Note 6)

`:mapset`=<dflt or the number of an existing MAP set> (See Note 3)

`:mrnset` = <MRN set ID from the `rtrv-mrn` output> (See Note 7)

`:mrnpc/mrnpca/mrnpci/mrnpcn/mrnpcn24`=<the point code value in the MRN set> (See Notes 7 and 8)

Table 2-44 (Cont.) Dominant Mated Application Parameter Combinations for the CHG-MAP Command**Notes**

- a. The format of the point codes in the CSPC group specified with the `grp` parameter must be the same as the primary point code specified with the `chg-map` command only if the ANSI/ITU SCCP Conversion feature is not enabled. If the ANSI/ITU SCCP Conversion feature is enabled, the CSPC group may contain a mixture of point code types (refer to the [Adding a Concerned Signaling Point Code](#) procedure), and the network type of the CSPC group can be different from the network type of the primary point code of the mated application.
- b. For mated applications containing ANSI or 24-bit ITU-N point codes, or the EAGLE's true point code, the format of the point codes specified in the `chg-map` command must be the same. For example, if the primary point code is a 24-bit ITU-N point code (`pcn24`), the mate point code must be a 24-bit ITU-N point code (`mpcn24`). The mate point codes of mated applications containing either ITU-I, ITU-I spare, 14-bit ITU-N, or 14-bit ITU-N spare primary point codes do not have to be the same format as the primary point code. The mate point codes of these mated applications can be a mixture of ITU-I, ITU-I spare, 14-bit ITU-N, or 14-bit ITU-N spare point codes.
- c. If the Flexible GTT Load Sharing is enabled, the `mapset` parameter must be specified with the `chg-map` command. If the Flexible GTT Load Sharing is not enabled, the `mapset` parameter cannot be specified with the `chg-map` command.
To provision entries in the default MAP set, the `mapset=deflt` parameter must be specified with the `chg-map` command.
To provision entries in an existing MAP set, the `mapset` parameter must be specified with the MAP set ID value of that MAP set.
A MAP set, other than the default MAP set, is a MAP group provisioned with the MAP set ID and can contain a maximum of 32 point code and subsystem entries.
The default MAP set can contain multiple MAP groups. Each group in the default MAP set can contain a maximum of 32 point code and subsystem entries.
The point code and subsystem entry can appear only once in the default MAP set, so the point code and subsystem entry can appear in only one MAP group in the default MAP set.
The point code and subsystem entry provisioned in a MAP set can be provisioned in multiple MAP sets. If a point code and subsystem entry is provisioned in different MAP sets, the relative cost value of the entry in each MAP set can be different. All the point code and subsystem entries in a MAP set, including the default MAP set, must be different.
- d. If the point code selected from either the `rtrv-rte` or `rtrv-map` outputs is a 14-bit ITU-N point code, then the `pcn/mpcn` parameters must be specified. If the point code selected from either the `rtrv-rte` or `rtrv-map` outputs is a 24-bit ITU-N point code, then the `pcn24/mpcn24` parameters must be specified.
- e. The `srn=yes` parameter can be specified only for mated applications containing ANSI point codes.
- f. When the CSPC group name (`grp`), `mrc`, `srn`, or `ssn` values for a specific point code and SSN in a mated application are changed, these parameter values for this specific point code and SSN in all applicable mated applications will be changed to the new values.
- g. The `mrnset` and `mrnpc/mrnpca/mrnpai/mrnpai/mrnpai/mrnpai` parameters can be specified only if the GTT Load Sharing with Alternate Routing Indicator feature is enabled. Refer to the [Activating the GTT Load Sharing with Alternate Routing Indicator Feature](#) procedure for information about enabling the GTT Load Sharing with

Table 2-44 (Cont.) Dominant Mated Application Parameter Combinations for the CHG-MAP Command

Alternate Routing Indicator feature. The `mrnset` and `mrnpc/mrnpca/mrnpai/mrnpai/mrnpai/mrnpai` values must be shown in the `rtrv-mrn` output.

- h.** The network type of the `pc/pca/pci/pcn/pcn24` and `mrnpc/mrnpca/mrnpai/mrnpai/mrnpai/mrnpai` parameter values must be compatible, as shown in [Table 2-41](#).

If the Flexible GTT Load Sharing feature is not enabled for this example, enter these commands.

```
chg-
map:pca=005-005-005:ssn=250:rc=10:mpca=070-070-070 :mssn=251:
materc=30:grp=grp05:mrc=yes:srm=yes:sso=on
```

```
chg-
map:pca=008-008-008:ssn=254:rc=10:mpca=031-049-100 :mssn=250:
materc=40:grp=grp15:mrc=yes:srm=yes:sso=on
```

```
chg-
map:pca=008-008-008:ssn=254:rc=10:mpca=056-113-200 :mssn=251:
materc=50:grp=grp05:mrc=yes:srm=yes:sso=off
```

```
chg-
map:pci=5-005-5:ssn=50:rc=10:mpci=s-5-005-6:mssn=50:materc=21
:grp=grp20:mrc=yes:sso=off
```

```
chg-
map:pci=5-005-5:ssn=50:rc=10:mpci=5-005-1:mssn=50:materc=22 :
grp=grp20:mrc=yes:sso=off
```

When each of these commands have successfully completed, this message should appear.

```
rlghncxa03w 07-05-07 11:44:13 GMT EAGLE5 37.0.0
CHG-MAP: MASP A - COMPLTD
```

If the Flexible GTT Load Sharing feature is enabled for this example, enter these commands.

```
chg-
map:pca=005-005-005:ssn=250:rc=10:mpca=070-070-070 :mssn=251:
materc=30:grp=grp05:mrc=yes:srm=yes:sso=on :mapset=df1t
```

```
chg-
map:pca=008-008-008:ssn=254:rc=10:mpc=179-183-050:mssn=250 :m
aterc=11:grp=grp15:sso=off:mapset=12
```

```
chg-
map:pca=008-008-008:ssn=254:rc=10:mpca=031-049-100 :mssn=250:
materc=40:grp=grp15:mrc=yes:srm=yes:sso=on:mapset=13
```

```
chg-
map:pca=008-008-008:ssn=254:rc=10:mpca=056-113-200 :mssn=251:
materc=50:grp=grp05:mrc=yes:srm=yes:sso=off:mapset=13
```

```
chg-
map:pci=5-005-5:ssn=50:rc=10:mpci=s-5-005-6:mssn=50:materc=21
:grp=grp20:mrc=yes:sso=off:mapset=14
```

```
chg-
map:pci=5-005-5:ssn=50:rc=10:mpci=5-005-1:mssn=50:materc=22 :
grp=grp20:mrc=yes:sso=off:mapset=14
```

If the GTT Load Sharing with Alternate Routing Indicator feature is enabled for this example, and the `mrnset` and `mrnpc` parameters were not specified in 16, enter these commands.

```
chg-
map:pca=005-005-005:ssn=250:rc=10:mpca=070-070-070 :mssn=251:
materc=30:grp=grp05:mrc=yes:srm=yes:sso=on :mapset=dflt:mrnse
t=1:mrnpc=007-007-007
```

```
chg-
map:pca=008-008-008:ssn=254:rc=10:mpc=179-183-050:mssn=250 :m
aterc=11:grp=grp15:sso=off:mapset=12:mrnset=dflt:mrnpc=005-00
5-005
```

When each of these commands have successfully completed, this message should appear.

```
rlghncxa03w 07-05-07 11:44:13 GMT EAGLE5 37.0.0
CHG-MAP: MASP A - COMPLTD
```

Repeat this step for all new entries being added to the existing mated application.

If the Flexible GTT Load Sharing feature is not enabled, the mated application can contain a maximum of 32 entries.

If the Flexible GTT Load Sharing feature is enabled, and the MAP set is not the default MAP set, the MAP set can contain a maximum of 32 entries.

If the Flexible GTT Load Sharing feature is enabled, and the MAP set is the default MAP set, the default MAP set can contain multiple MAP groups. Each group in the default MAP set can contain a maximum of 32 point code and subsystem entries.

18. Verify the changes using the `rtrv-map` command with the primary point code and subsystem specified in 16 and 17.

If a new MAP set was created in 16, the `mapset` parameter should be specified with the `rtrv-map` command. The value for the `mapset` parameter should be the MAP set ID generated in 16.

If the mated application was added to an existing MAP in 17, the `mapset` parameter and value specified in 17 should be specified with the `rtrv-map` command.

If the Flexible GTT Load Sharing feature is not enabled for this example, enter these commands.

```
rtrv-map:pca=003-003-003:ssn=254
```

This is an example of the possible output.

```
rlghncxa03w 09-02-07 00:34:31 GMT EAGLE5 40.1.0
```

```
PCA          Mate PCA      SSN RC MULT SRM MRC GRP NAME SSO
```

```
003-003-003          254 10  DOM YES YES grp10  ON
                   040-040-040 254 20  DOM YES YES grp10  ON
```

MAP TABLE IS (38 of 1024) 4 % FULL

rtrv-map:pca=005-005-005:ssn=250

This is an example of the possible output.

rlghncxa03w 09-02-07 00:34:31 GMT EAGLE5 40.1.0

PCA	Mate PCA	SSN	RC	MULT	SRM	MRC	GRP	NAME	SSO
005-005-005		250	10	DOM	YES	YES	grp15		OFF
	060-060-060	250	20	DOM	YES	YES	grp15		OFF
	070-070-070	251	30	DOM	YES	YES	grp05		ON

MAP TABLE IS (38 of 1024) 4 % FULL

rtrv-map:pca=008-008-008:ssn=254

This is an example of the possible output.

rlghncxa03w 09-02-07 00:34:31 GMT EAGLE5 40.1.0

PCA	Mate PCA	SSN	RC	MULT	SRM	MRC	GRP	NAME	SSO
008-008-008		254	10	DOM	YES	YES	grp10		ON
	031-049-100	250	40	DOM	YES	YES	grp15		ON
	056-113-200	251	50	DOM	YES	YES	grp05		OFF

MAP TABLE IS (38 of 1024) 4 % FULL

rtrv-map:pci=5-005-5:ssn=50

This is an example of the possible output.

rlghncxa03w 09-02-07 00:34:31 GMT EAGLE5 40.1.0

PCI	NET	Mate PC	SSN	RC	MULT	SRM	MRC	GRP	NAME	SSO
5-005-5			50	10	DOM	NO	YES	grp20		OFF
	N	0257	50	20	DOM	NO	YES	grp20		OFF
	I	s-5-005-6	50	21	DOM	NO	YES	grp20		OFF
	I	5-005-1	50	22	DOM	NO	YES	grp20		OFF

MAP TABLE IS (38 of 1024) 4 % FULL

 **Note:**

If the Weighted GTT Load Sharing feature is enabled, the `WT`, `%WT`, and `THR` columns are shown in the `rtrv-map` output.

If the Flexible GTT Load Sharing feature is enabled for this example, enter these commands.

rtrv-map:pca=003-003-003:ssn=254:mapset=11

This is an example of the possible output.

rlghncxa03w 09-02-07 00:34:31 GMT EAGLE5 40.1.0

MAPSET ID=11	MRNSET=DFLT	MRNPC=005-005-005							
PCA	Mate PCA	SSN RC	MULT	SRM	MRC	GRP	NAME	SSO	
003-003-003		254 10	DOM	YES	YES	grp10		ON	
	040-040-040	254 20	DOM	YES	YES	grp10		ON	

MAP TABLE IS (38 of 36000) 1 % FULL

rtrv-map:pca=005-005-005:ssn=250:mapset=dflt

This is an example of the possible output.

rlghncxa03w 09-02-07 00:34:31 GMT EAGLE5 40.1.0

MAPSET ID=DFLT	MRNSET=1	MRNPC=007-007-007							
PCA	Mate PCA	SSN RC	MULT	SRM	MRC	GRP	NAME	SSO	
005-005-005		250 10	DOM	YES	YES	grp15		OFF	
	060-060-060	250 20	DOM	YES	YES	grp15		OFF	
	070-070-070	251 30	DOM	YES	YES	grp05		ON	

MAP TABLE IS (38 of 36000) 1 % FULL

rtrv-map:pca=008-008-008:ssn=254:mapset=13

This is an example of the possible output.

rlghncxa03w 09-02-07 00:34:31 GMT EAGLE5 40.1.0

MAPSET ID=13	MRNSET=DFLT	MRNPC=005-005-005							
PCA	Mate PCA	SSN RC	MULT	SRM	MRC	GRP	NAME	SSO	
008-008-008		254 10	DOM	YES	YES	grp10		ON	
	031-049-100	250 40	DOM	YES	YES	grp15		ON	
	056-113-200	251 50	DOM	YES	YES	grp05		OFF	

MAP TABLE IS (38 of 36000) 1 % FULL

rtrv-map:pci=5-005-5:ssn=50:mapset=14

This is an example of the possible output.

rlghncxa03w 09-02-07 00:34:31 GMT EAGLE5 40.1.0

MAPSET ID=14	MRNSET ID=----	MRNPC=-----							
PCI	NET	Mate PC	SSN RC	MULT	SRM	MRC	GRP	NAME	SSO
5-005-5			50 10	DOM	NO	YES	grp20		OFF
	N	0257	50 20	DOM	NO	YES	grp20		OFF
	I	s-5-005-6	50 21	DOM	NO	YES	grp20		OFF
	I	5-005-1	50 22	DOM	NO	YES	grp20		OFF

```
MAP TABLE IS (38 of 36000) 4 % FULL
```

If the Weighted GTT Load Sharing feature is enabled, the WT, %WT, and THR columns are shown in the `rtrv-map` output.

If the GTT Load Sharing with Alternate Routing Indicator feature is not enabled, the MRNSET and MRNPC fields are not shown in the `rtrv-map` output.

19. Back up the new changes using the `chg-db:action=backup:dest=fixed` command.

```
BACKUP (FIXED) : MASP A - Backup starts on active MASP.
```

```
BACKUP (FIXED) : MASP A - Backup on active MASP to fixed disk  
complete.
```

```
BACKUP (FIXED) : MASP A - Backup starts on standby MASP.
```

```
BACKUP (FIXED) : MASP A - Backup on standby MASP to fixed disk  
complete.
```

Figure 2-63 Provision a Dominant Mated Application- Sheet 1 of 17

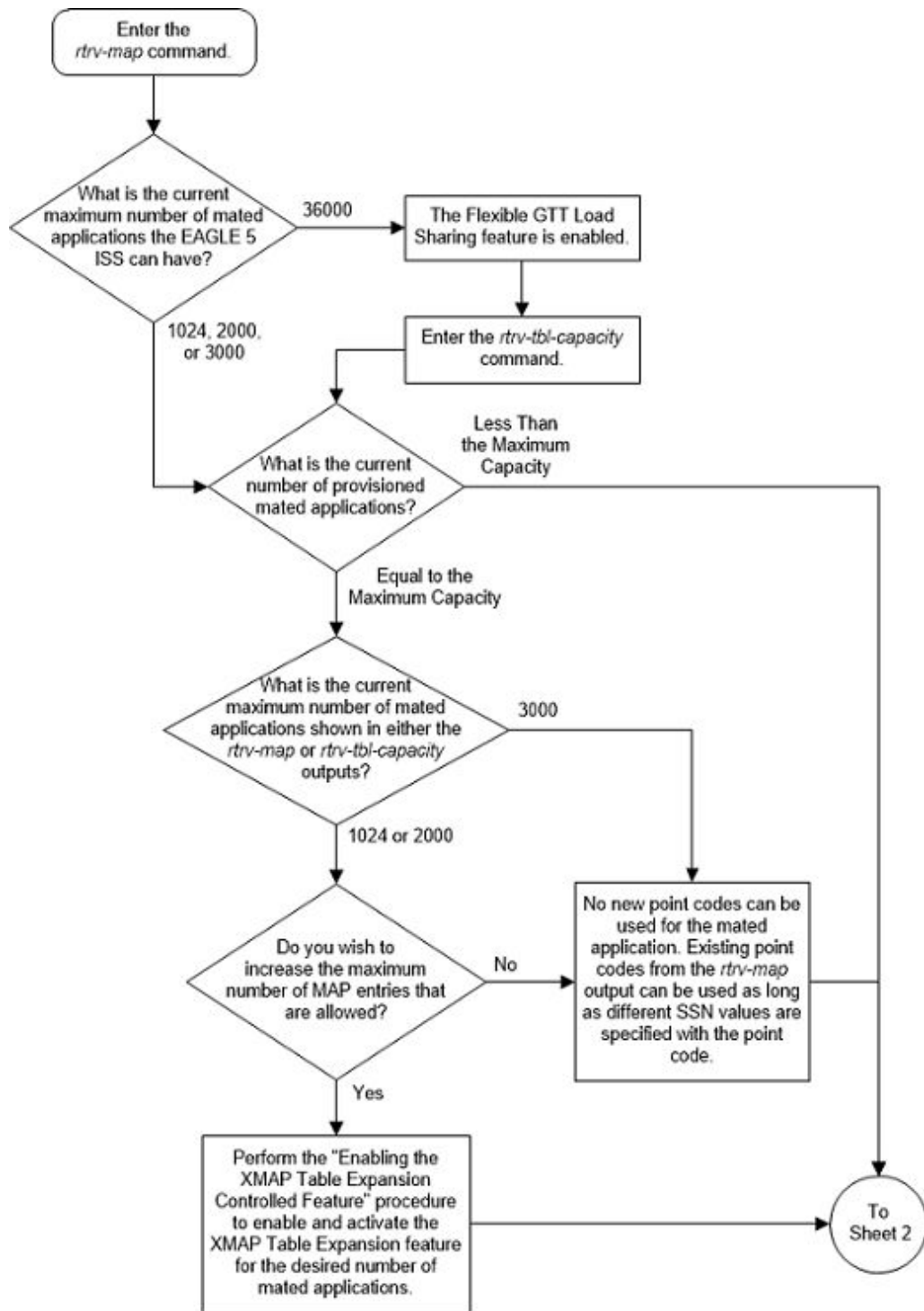

Figure 2-64 Provision a Dominant Mated Application - Sheet 2 of 17

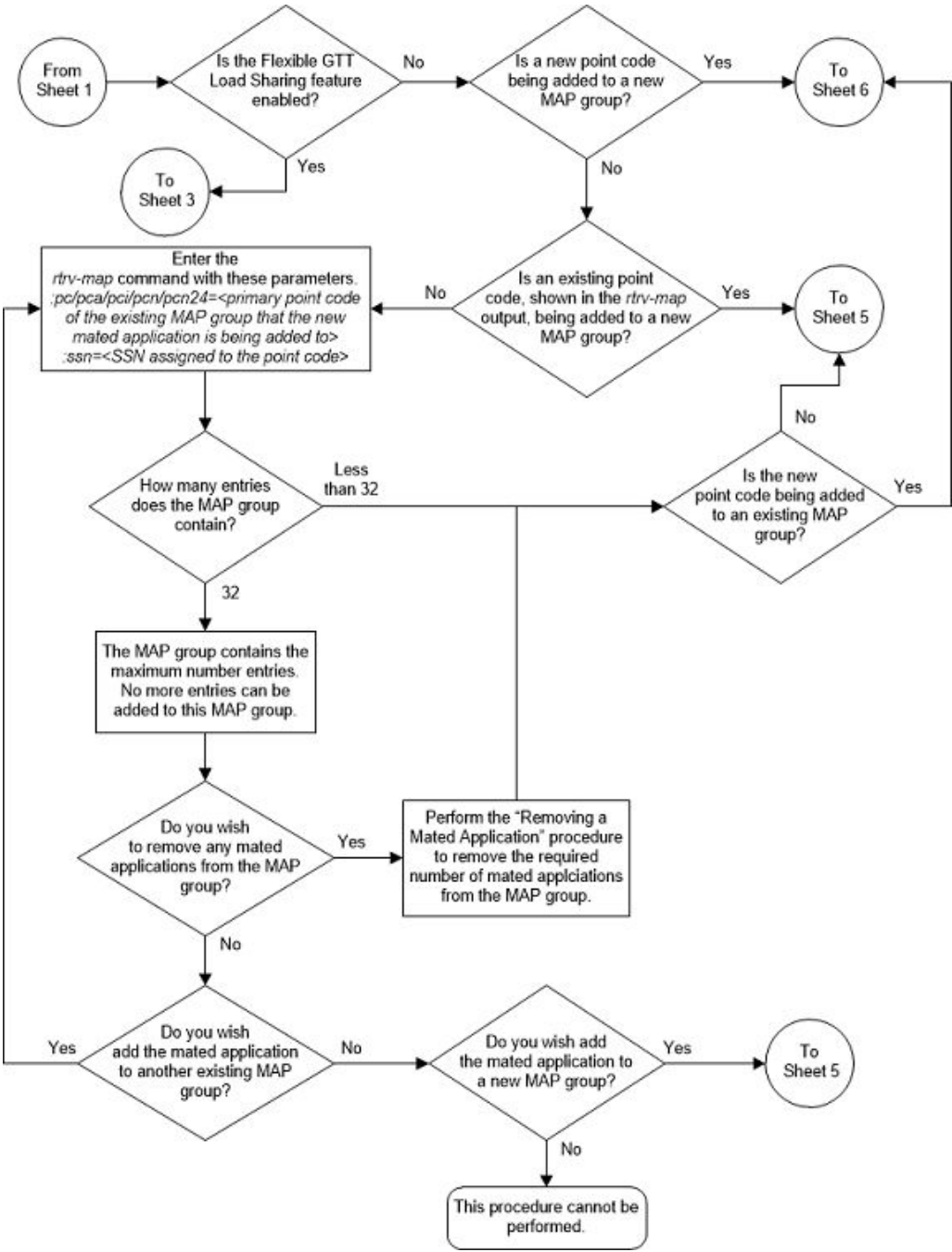

Figure 2-65 Provision a Dominant Mated Application - Sheet 3 of 17

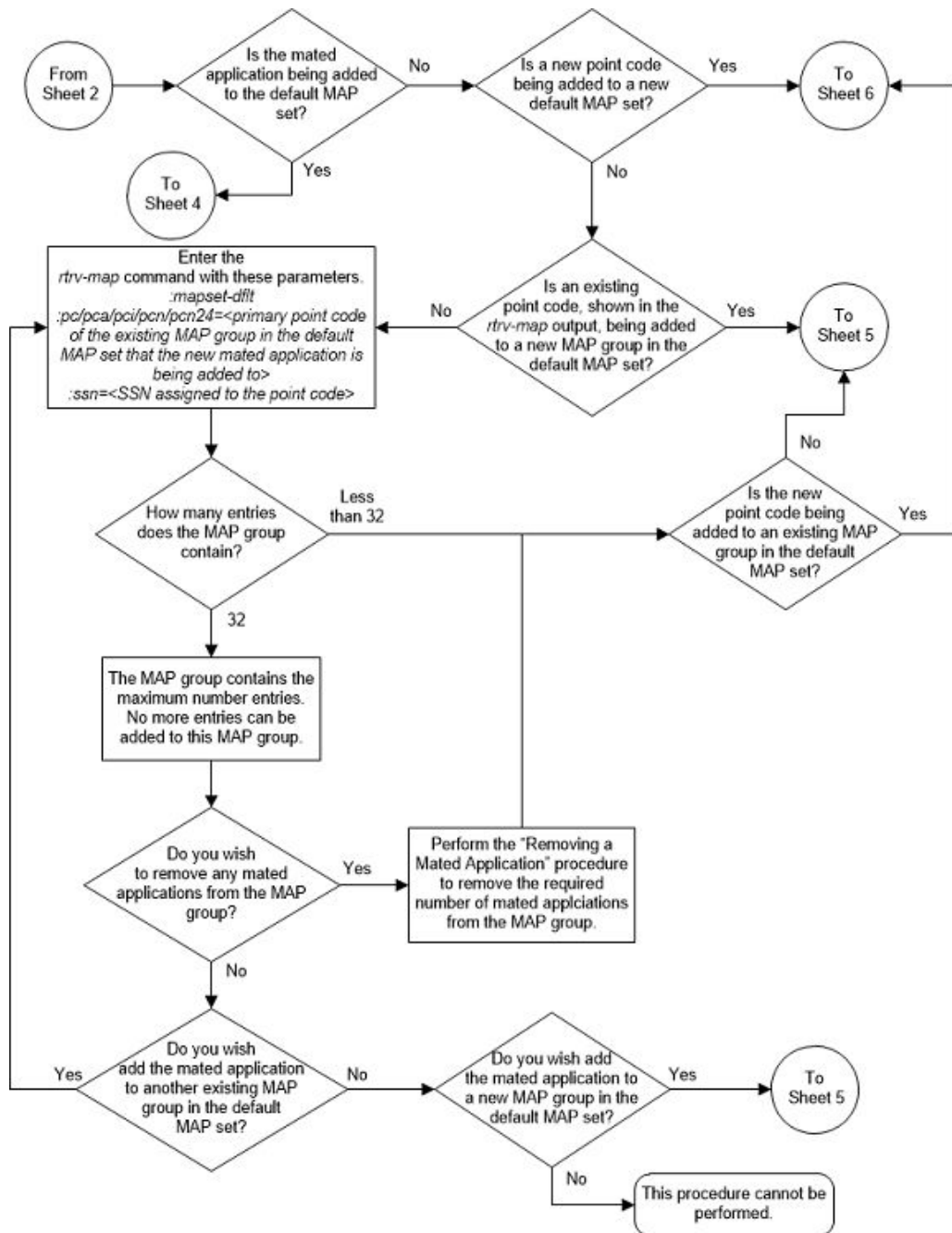

Figure 2-66 Provision a Dominant Mated Application - Sheet 4 of 17

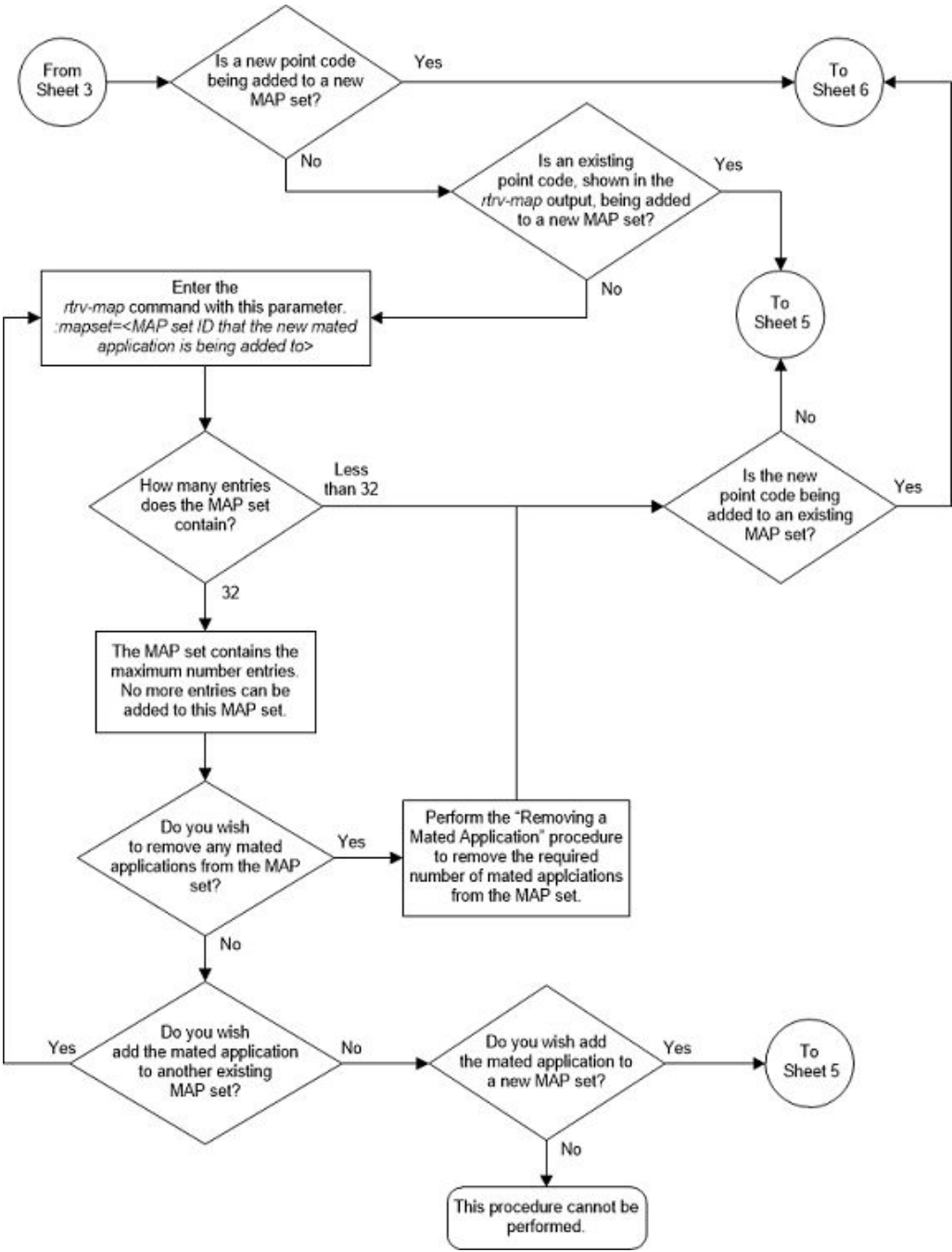

Figure 2-67 Provision a Dominant Mated Application - Sheet 5 of 17

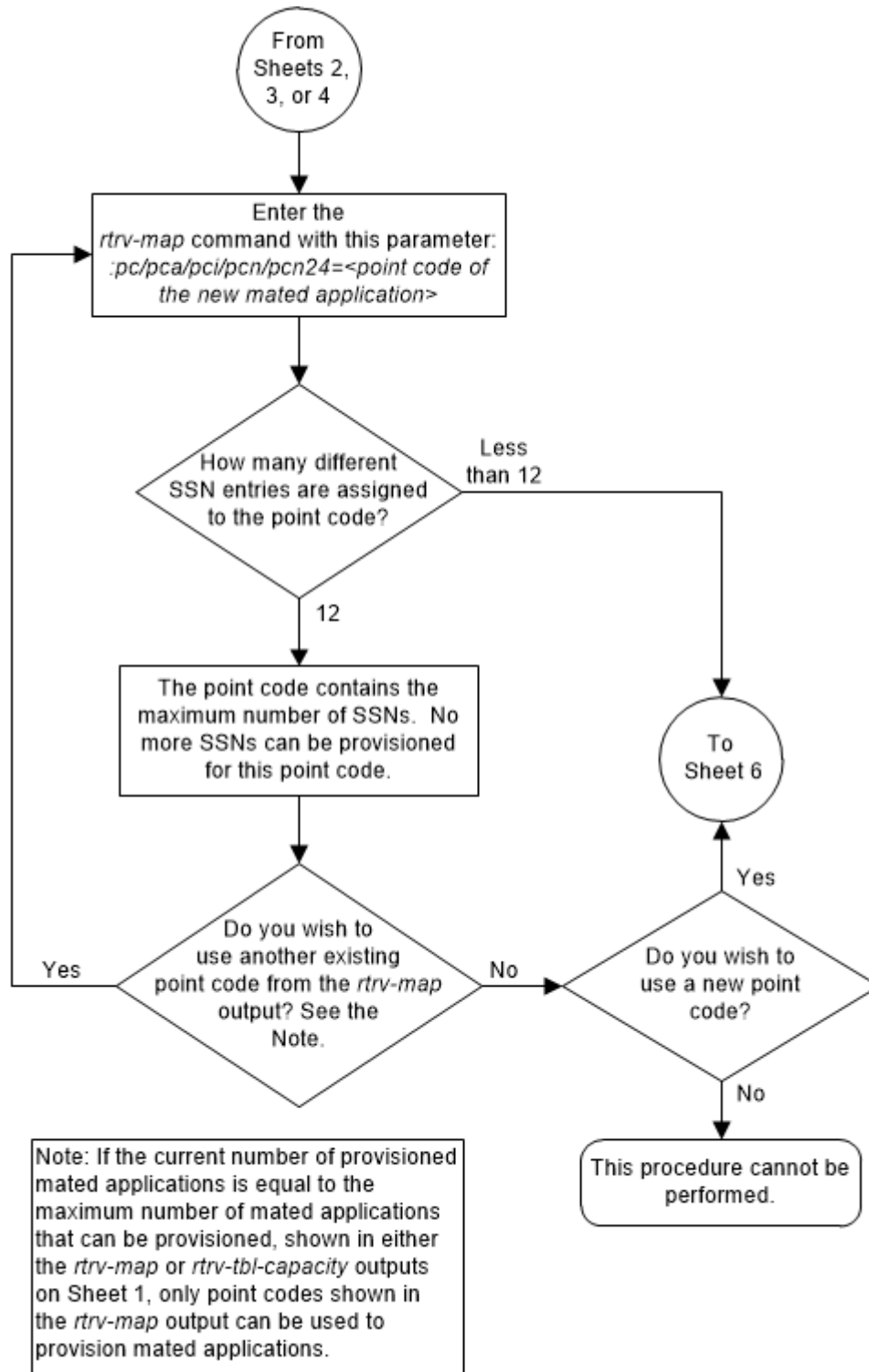

Figure 2-68 Provision a Dominant Mated Application - Sheet 6 of 17

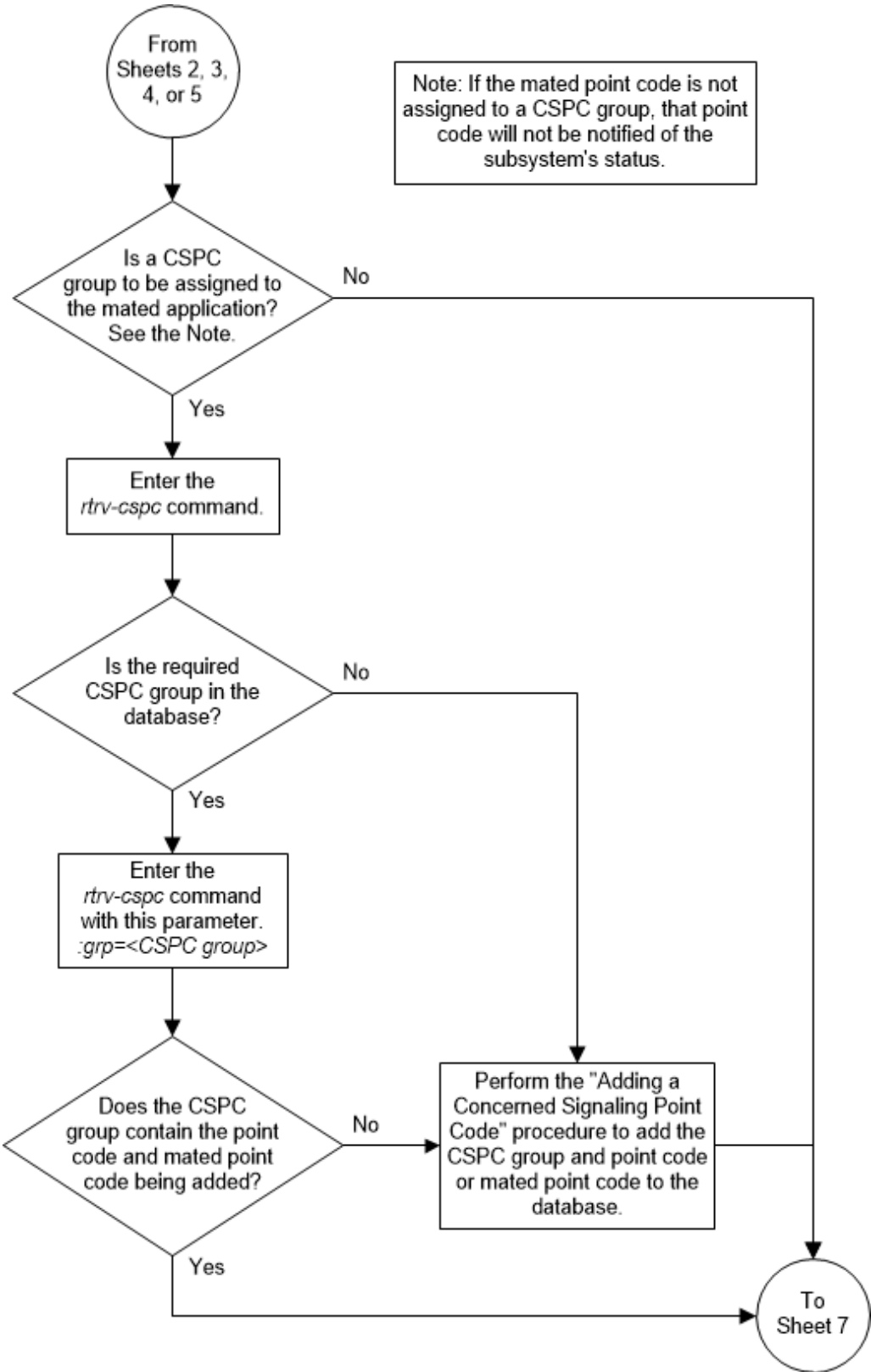

Figure 2-69 Provision a Dominant Mated Application - Sheet 7 of 17

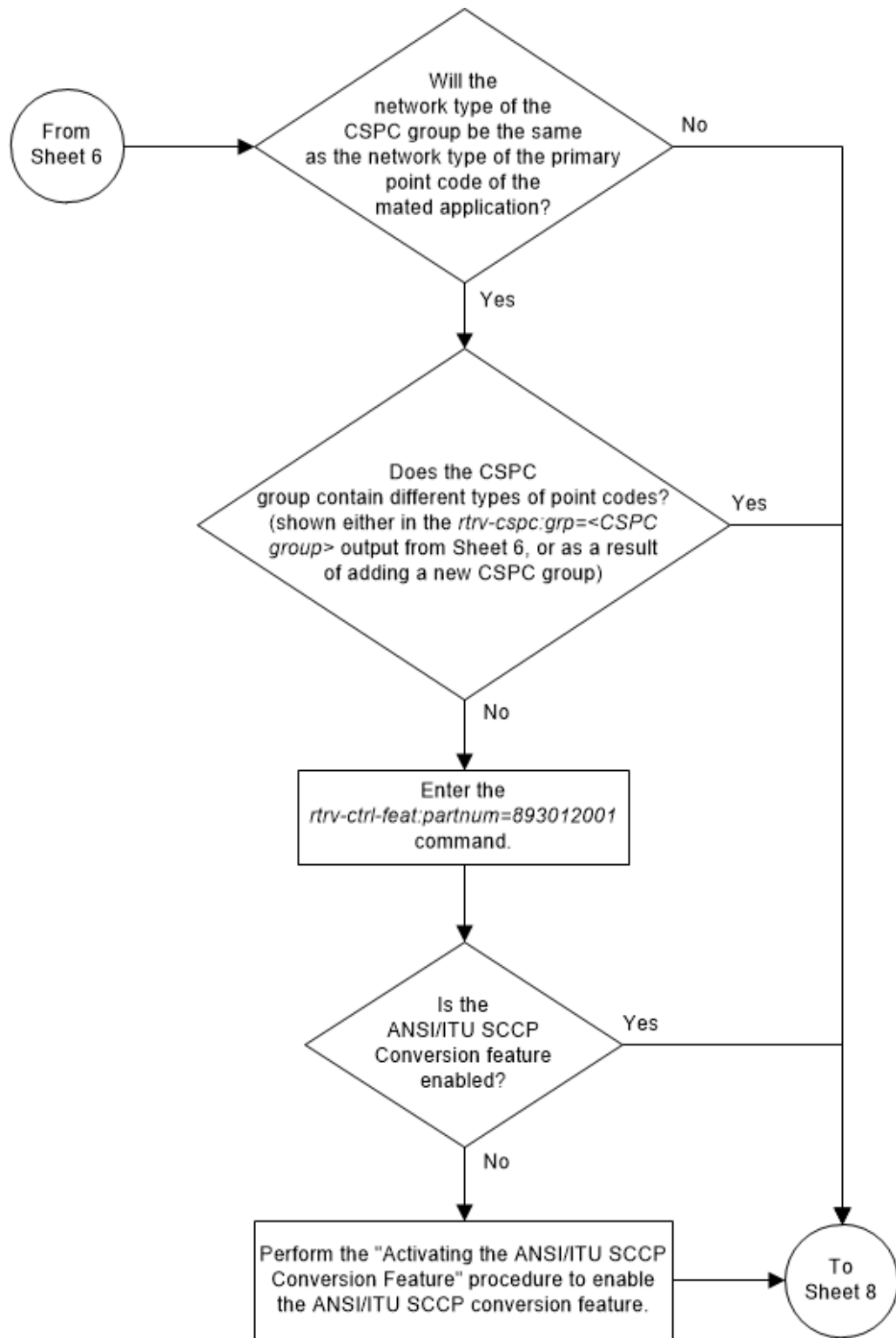

Figure 2-70 Provision a Dominant Mated Application - Sheet 8 of 17

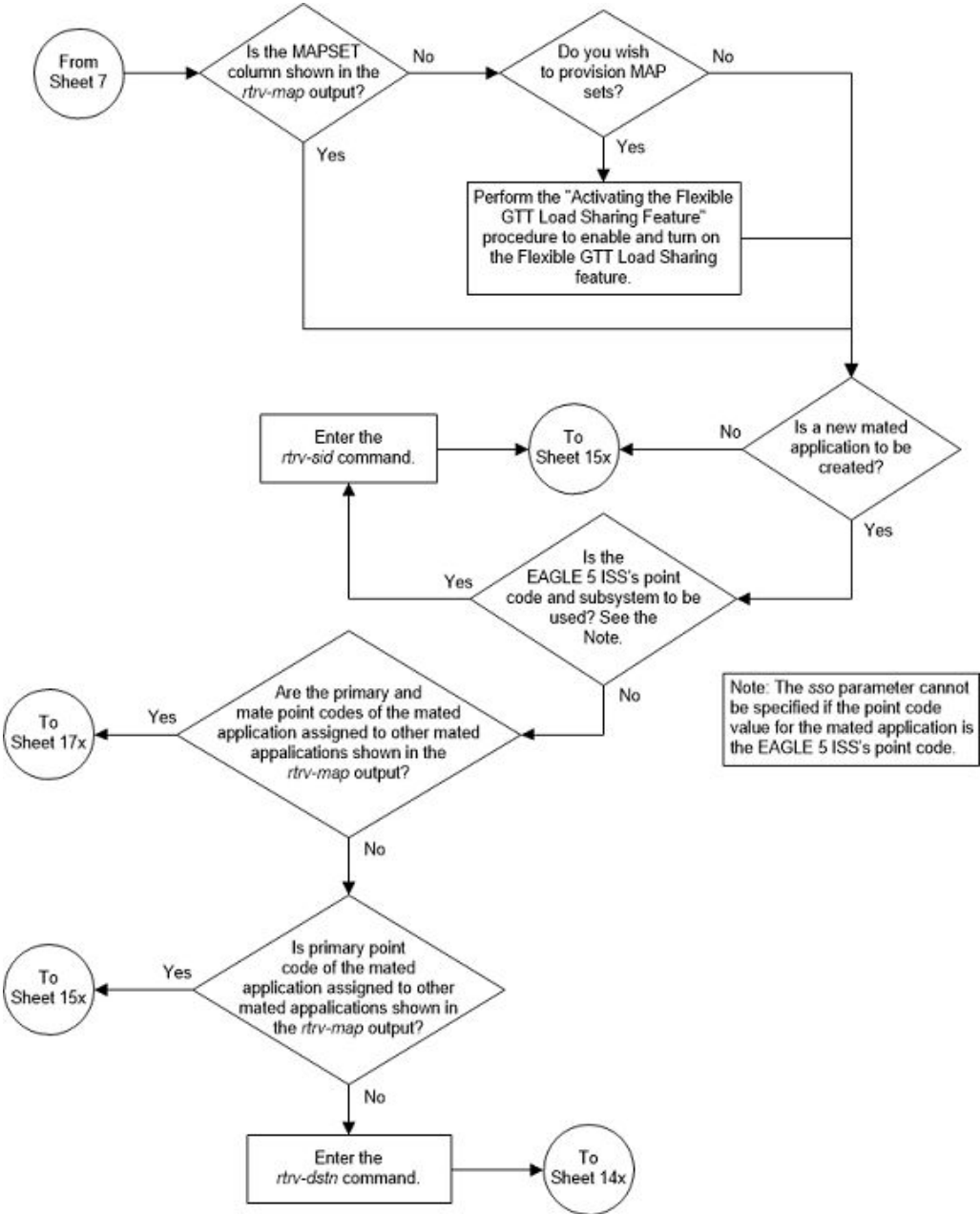

Figure 2-71 Provision a Dominant Mated Application - Sheet 9 of 17

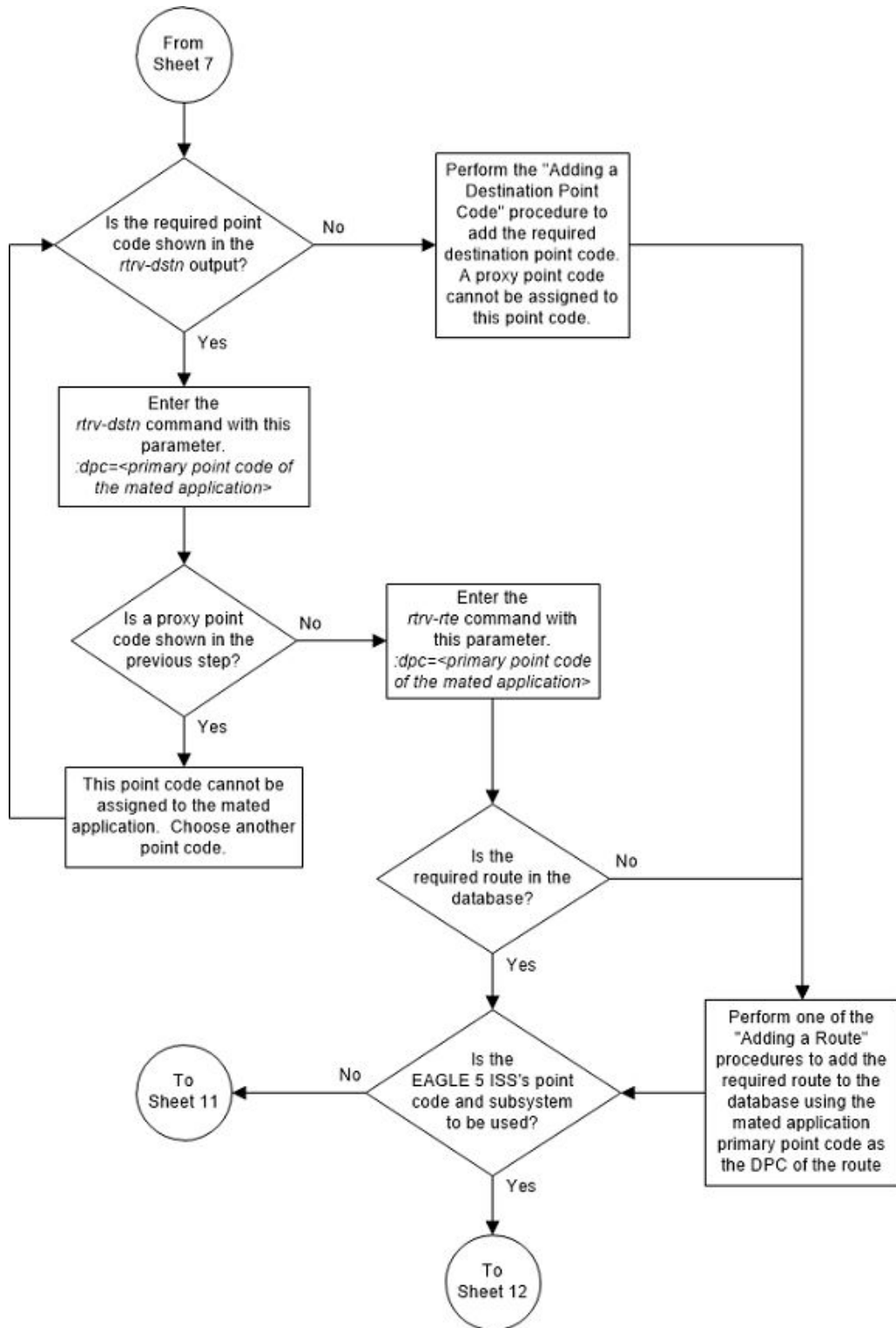

Figure 2-72 Provision a Dominant Mated Application - Sheet 10 of 17

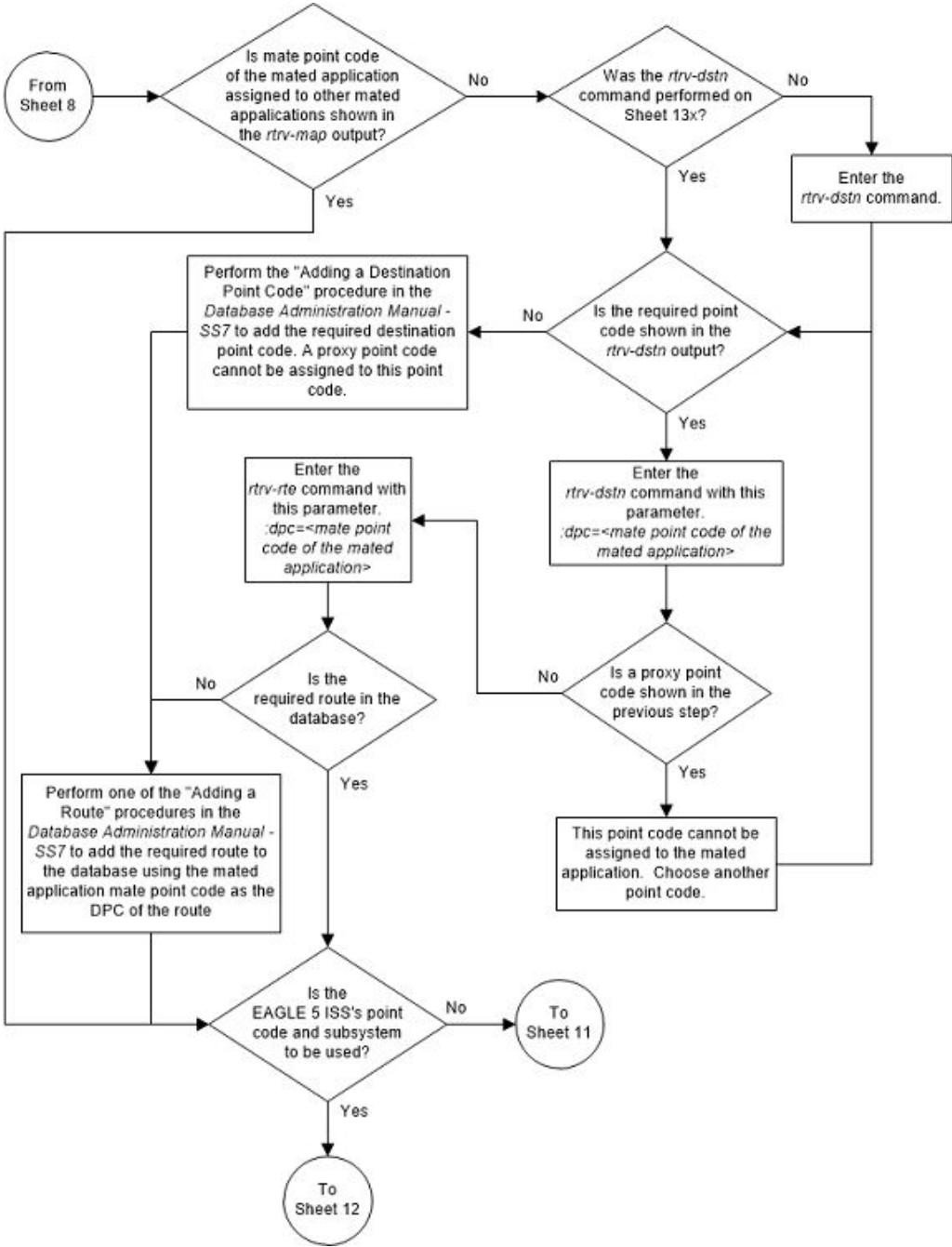

Figure 2-73 Provision a Dominant Mated Application - Sheet 11 of 17

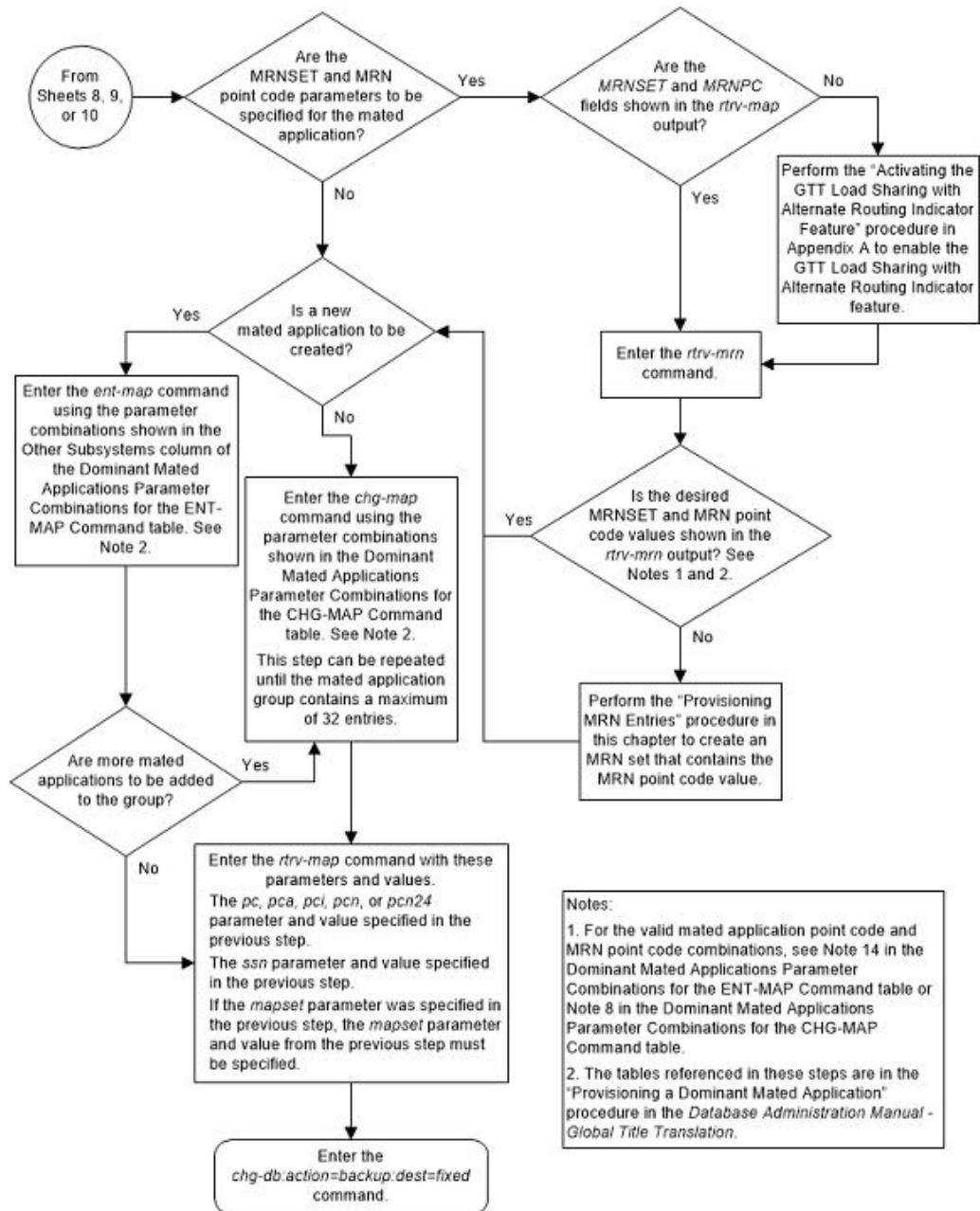

Figure 2-74 Provision a Dominant Mated Application - Sheet 12 of 17

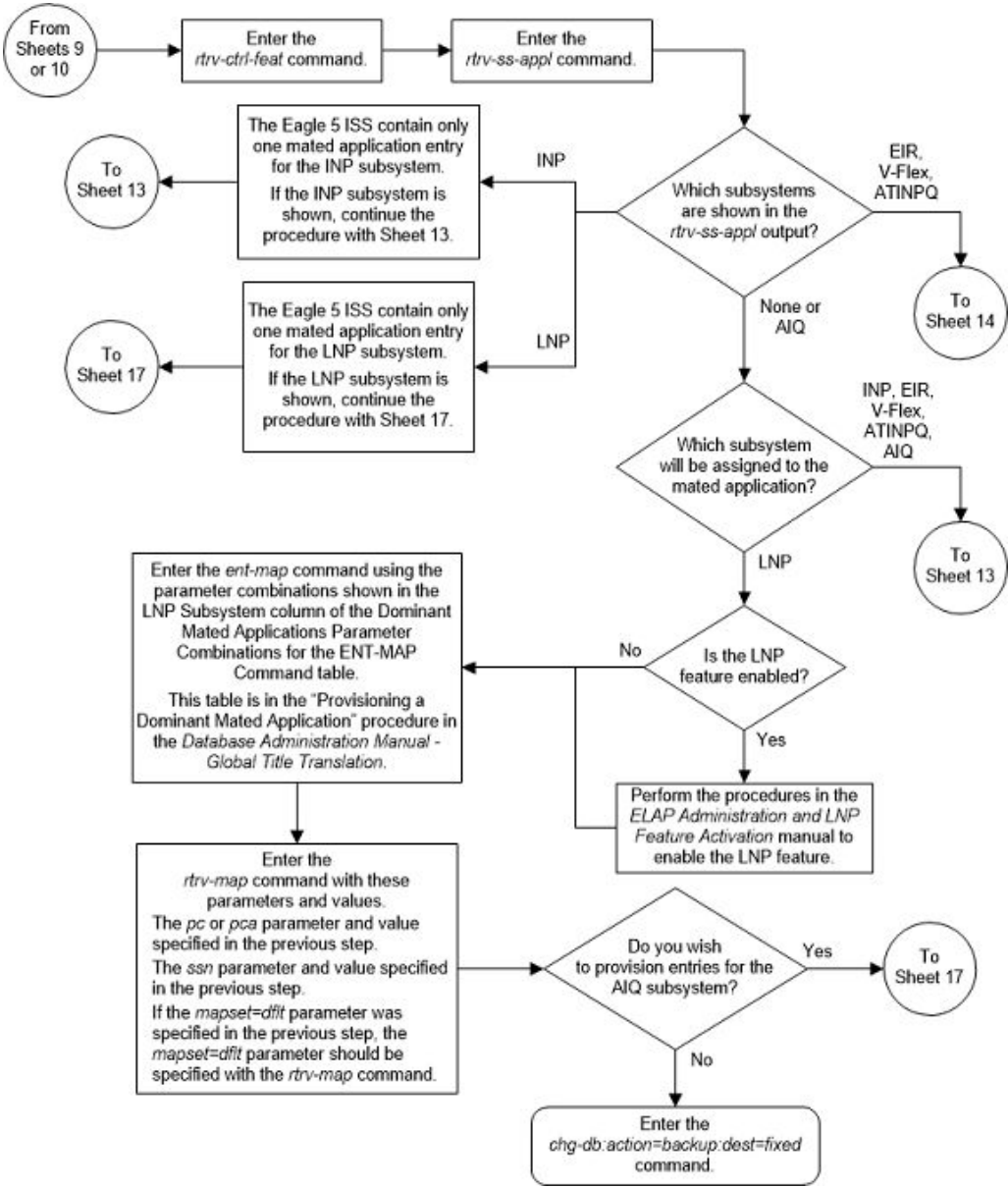

Figure 2-75 Provision a Dominant Mated Application - Sheet 13 of 17

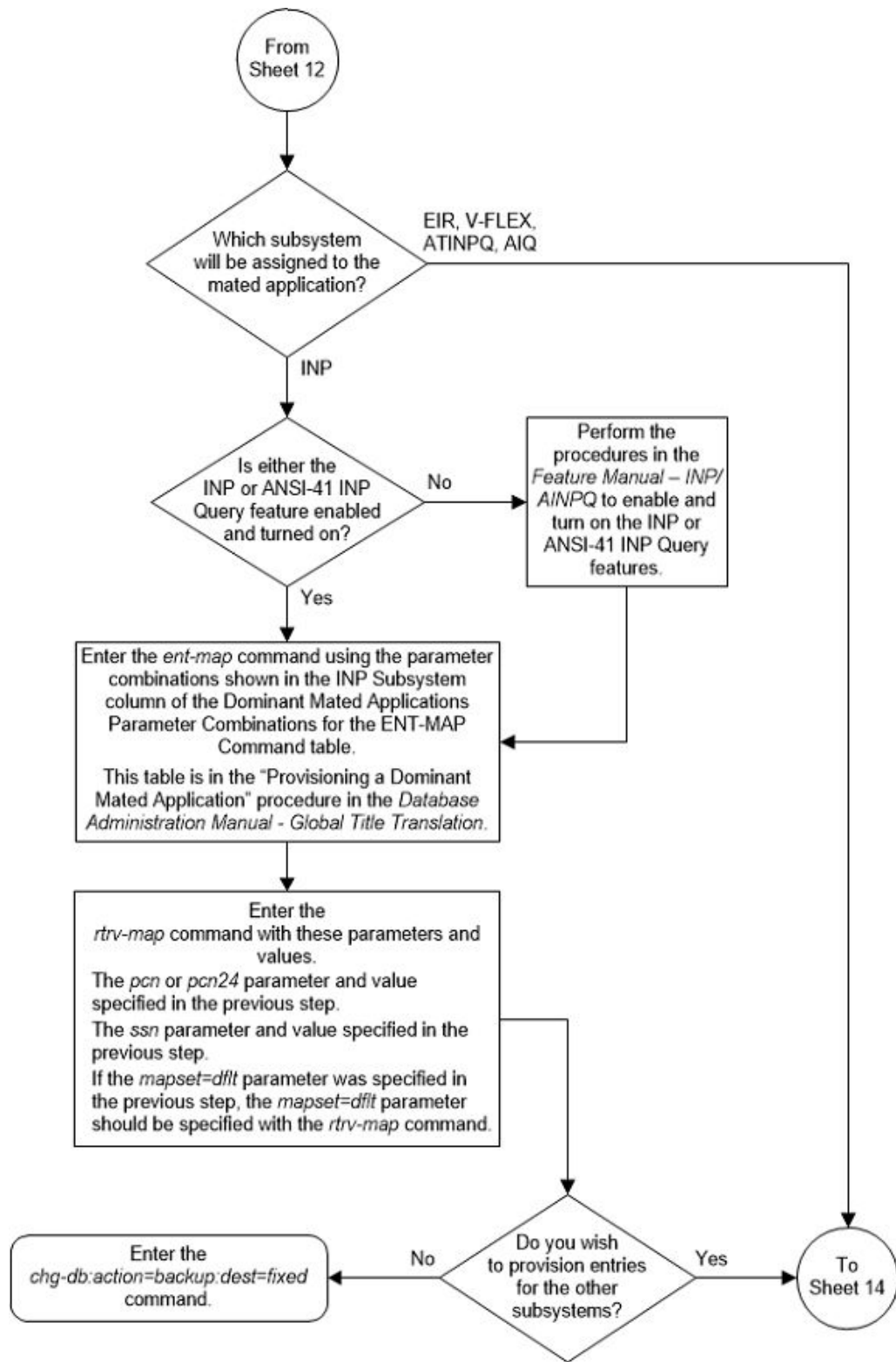

Figure 2-76 Provision a Dominant Mated Application - Sheet 14 of 17

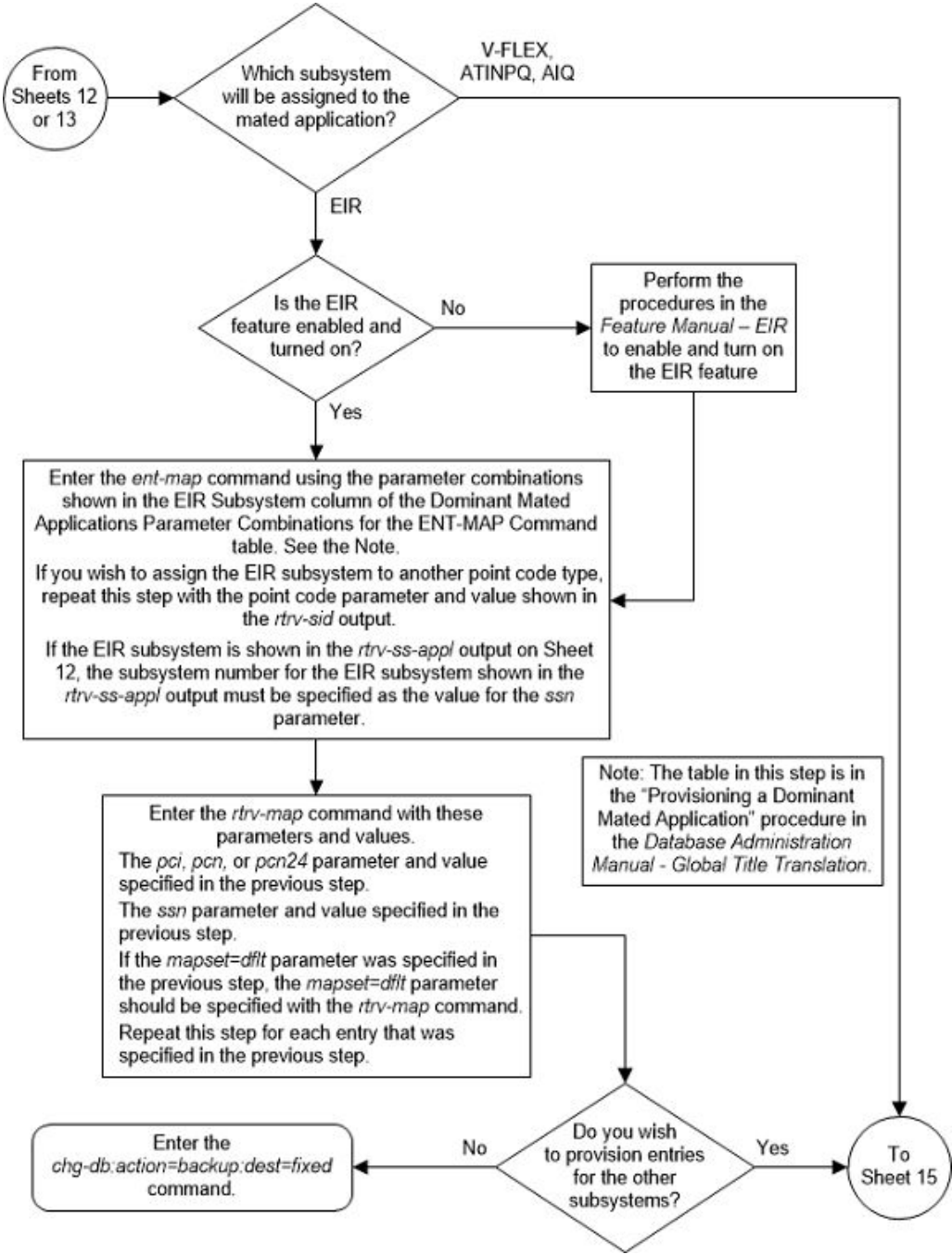

Figure 2-77 Provision a Dominant Mated Application - Sheet 15 of 17

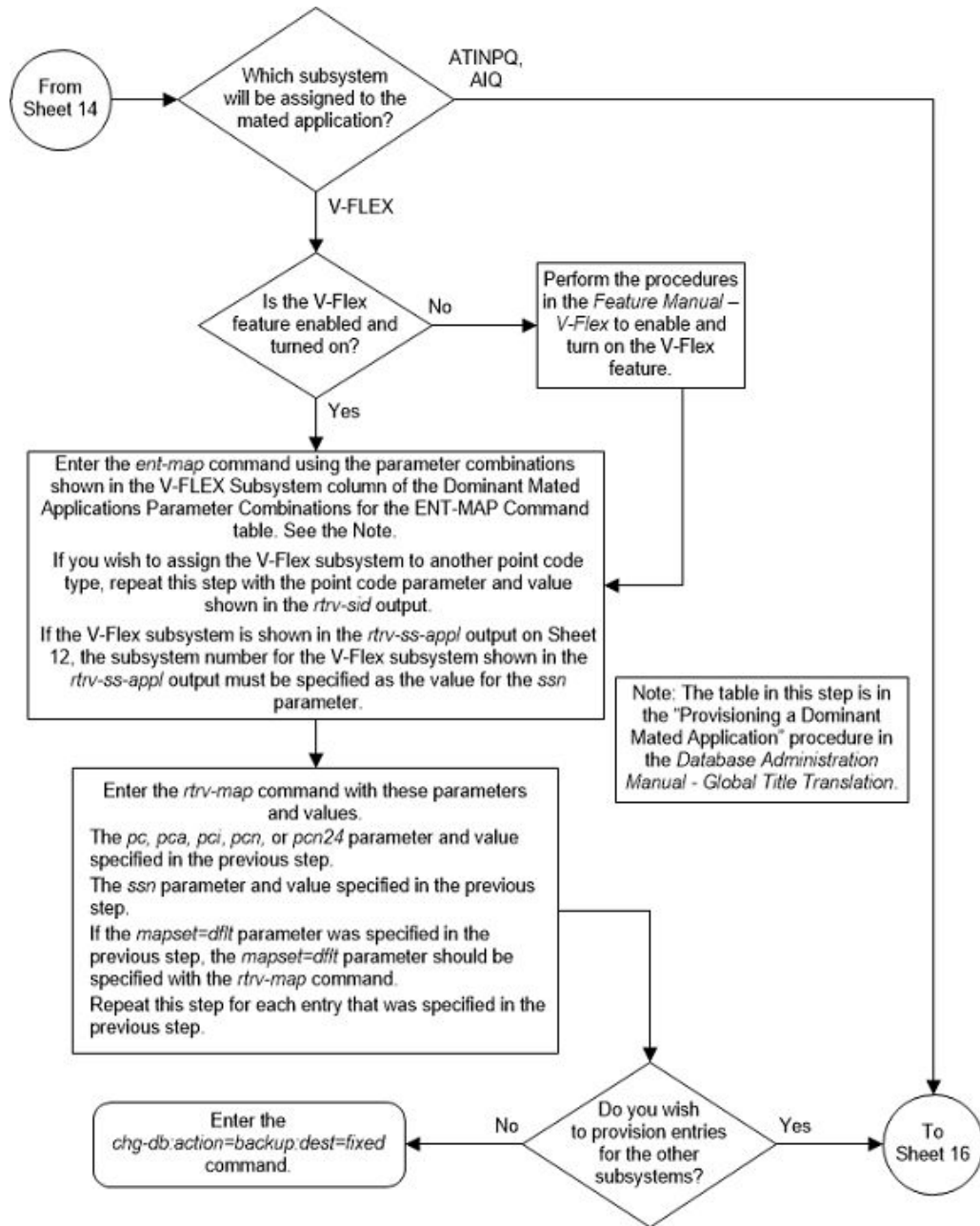

Figure 2-78 Provision a Dominant Mated Application - Sheet 16 of 17

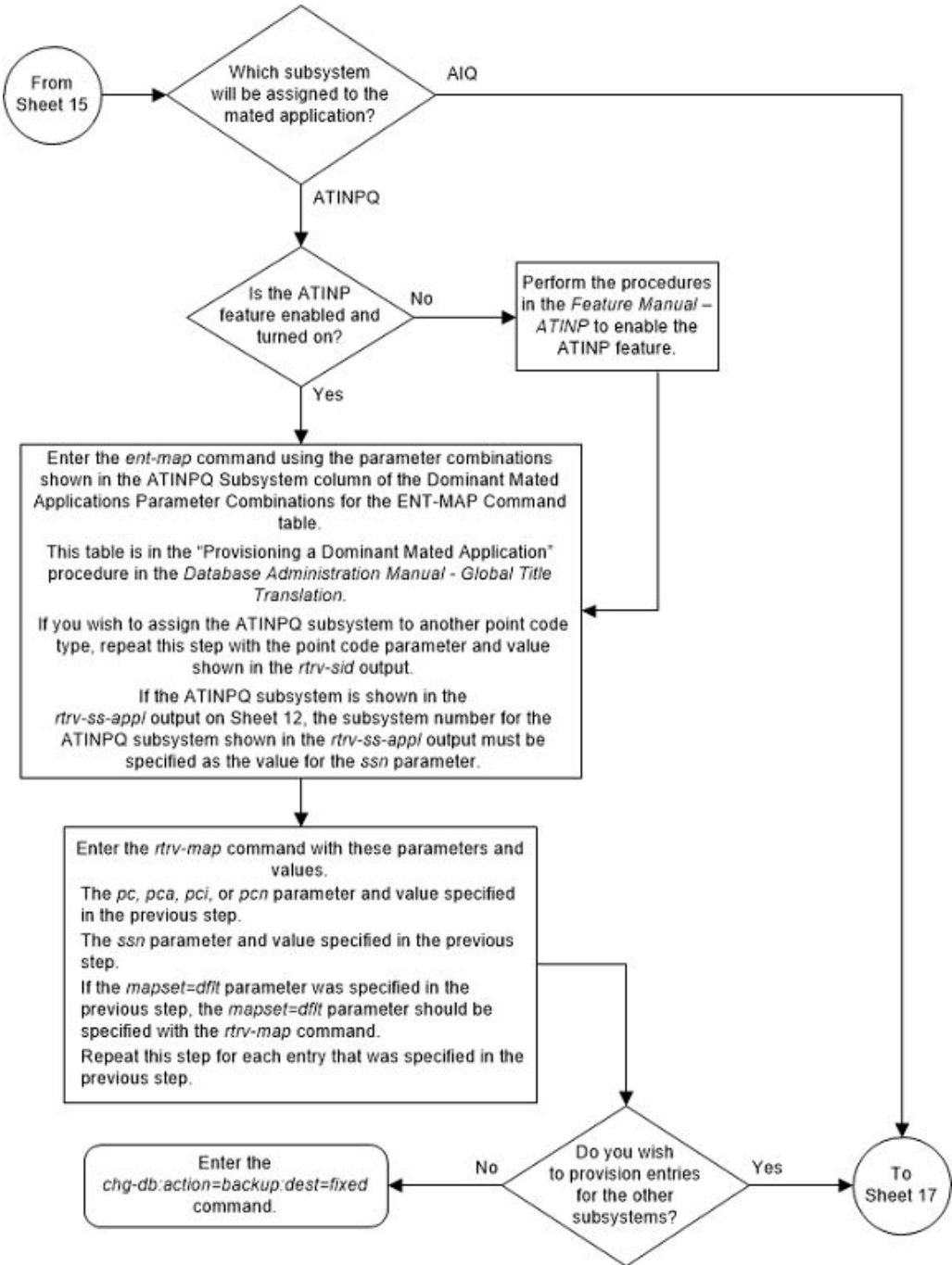
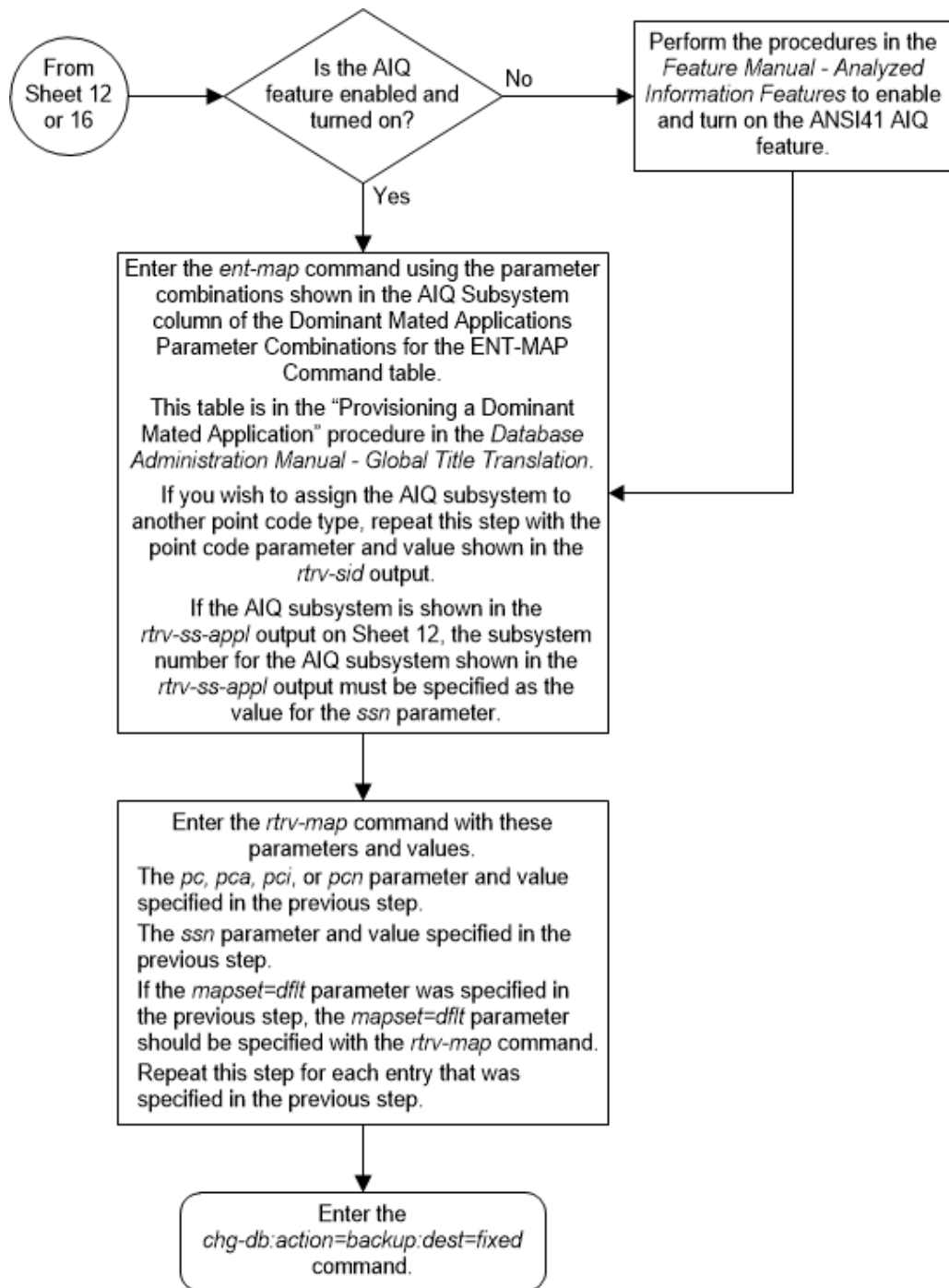

Figure 2-79 Provision a Dominant Mated Application - Sheet 17 of 17



Provisioning a Load Shared Mated Application

This procedure is used to provision a load shared mated application in the database using the `ent-map` and `chg-map` commands. A load shared mated application is a mated application containing entries whose RC (relative cost) values are equal. The

`ent-map` and `chg-map` commands use these parameters to provision a load shared mated application.

`:pc/pca/pci/pcn/pcn24` – The point code of the primary signaling point that is to receive the message.

`:mpc/mpca/mpci/mpcn/mpcn24` – The point code of the backup signaling point that is to receive the message.

 **Note:**

The point codes can be either an ANS point code (`pc/pca`, `mpc/mpca`), ITU-I or ITU-I spare point code (`pci`, `mpci`), a 14-bit ITU-N or 14-bit ITU-N spare point code (`pcn`, `mpcn`), or a 24-bit ITU-N (`pcn24`, `mpcn24`) point code.

 **Note:**

Refer to Chapter 2, *Configuring Destination Tables in Database Administration - SS7 User's Guide* for a definition of the point code types that are used on the EAGLE and for a definition of the different formats that can be used for ITU national point codes.

`:ssn` – Subsystem number – the subsystem address of the primary point code that is to receive the message. The value for this parameter is 2 to 255.

`:mssn` – Mate subsystem number – the subsystem address of the backup point code that is to receive the message. The value for this parameter is 2 to 255.

`:rc` – The relative cost value of the primary point code and subsystem, defined by the `pc/pca/pci/pcn/pcn24` and `ssn` parameters. The `rc` parameter has a range of values from 0 to 99, with the default value being 10.

`:materc` – The relative cost value of the backup point code and subsystem, defined by the `mpc/mpca/mpci/mpcn/mpcn24` and `mssn` parameters. The `materc` parameter has a range of values from 0 to 99, with the default value being 50.

`:grp` – The name of the concerned signaling point code group that contains the point codes that should be notified of the subsystem status. This parameter applies to both RPCs/SSNs. The value for this parameter is shown in the `rtrv-cspc` output. If the desired value is not shown in the `rtrv-cspc` output, perform the [Adding a Concerned Signaling Point Code](#) procedure to add the desired group. If this parameter is not specified, then a CSPC group name is not specified for the mated application.

`:sso` – Subsystem Status Option – defines whether the subsystem status option is on or off. This parameter allows the user the option to have the specified subsystem marked as prohibited even though an MTP-RESUME message has been received by the indicating that the specified point code is allowed. The value for this parameter is `on` or `off`. The default value is `off`.

`:mapset` – The MAP set ID that the mated applications are assigned to. This parameter can be specified only if the Flexible GTT Load Sharing feature is enabled. This parameter must be specified if the Flexible GTT Load Sharing feature is enabled. If the Flexible GTT Load Sharing feature is enabled, the point code and subsystem

specified for the global title translation must be assigned to the MAP set specified by this parameter. The status of the Flexible GTT Load Sharing feature is shown in the `rtrv-ctrl-feat` output. To enable the Flexible GTT Load Sharing feature, perform the [Activating the Flexible GTT Load Sharing Feature](#) procedure.

The `mapset` parameter has three values.

- `df1t` – to assign the MAP to the default MAP set. This value can be specified with both the `ent-map` and `chg-map` commands.
- `new` – to assign the mated application to a new MAP set. This value can be specified only with the `ent-map` command.
- The specific number of an existing MAP set if you are assigning the mated application to an existing MAP set. This value can be specified only with the `chg-map` command.
Refer to the [Provisioning a MAP Set](#) section for information on provisioning MAP sets.

`:wt` – The weight value assigned to the `pc/pca/pci/pcn/pcn24` parameter value. The value of this parameter is from 1 - 99.

`:mwt` – The weight value assigned to the `mpc/mpca/mpci/mpcn/mpcn24` parameter value. The value of this parameter is from 1 - 99.

`:thr` – The in-service threshold assigned to the MAP group or MAP set. The in-service threshold is the minimum percentage (from 1 - 100) of weight that must be available for an RC group (a group of entries in the MAP group or MAP set that have the same RC value assigned) to be considered available to carry traffic. If the percentage of the available weight is less than the in-service threshold, then the entire RC group is considered unavailable for traffic. If the percentage of the available weight is equal to or greater than the in-service threshold, then the RC group is considered available, and traffic can be sent to any available entity in the RC group. The value of the `thr` parameter is assigned to all entries that have the same RC (relative cost) value in the MAP group or MAP set that contain the point code specified in the `ent-map` or `chg-map` command.

Refer to the [Provisioning Weights and In-Service Thresholds for Mated Applications](#) section for information on provisioning MAP groups or MAP sets with weight and in-service threshold values.

`:mrnset` – The MRN set ID that is being assigned to the mated application. This is the MRN set from which alternate routing indicator searches are performed.

`:mrnpc/mrnpc/mrnpci/mrnpcn/mrnpcn24` – The point code assigned to the `mrnset` that is being assigned to the MAP set.

The current values of the `mrnset` and `:mrnpc/mrnpc/mrnpci/mrnpcn/mrnpcn24` parameters are shown in the `rtrv-map` output only if the Flexible GTT Load Sharing and the GTT Load Sharing with Alternate Routing Indicator features are enabled.

The new values for the `mrnset` and `mrnpc/mrnpc/mrnpci/mrnpcn/mrnpcn24` parameters must be shown in the `rtrv-mrn` output.

The network type of the `pc/pca/pci/pcn/pcn24` and `mrnpc/mrnpc/mrnpci/mrnpcn/mrnpcn24` parameter values must be compatible, as shown in [Table 2-45](#).

Table 2-45 MAP and MRN Point Code Parameter Combinations

MAP Point Code Parameter	MRN Point Code Parameter
pc/pca	mrnpc/mrnpca
pci or pcn (See Notes 1 and 2)	mrnpci or mrnpcn (See Notes 1 and 2)
pcn24	mrnpcn24

Notes:

1. If the network type of the MAP point code parameter is ITU-I (`pci`), the network type of the MRN point code parameter can be either ITU-I (`mrnpci`) or ITU-N (`mrnpcn`).
2. If the network type of the MAP point code parameter is ITU-N (`pcn`), the network type of the MRN point code parameter can be either ITU-I (`mrnpci`) or ITU-N (`mrnpcn`).

`:mrc` – Message routing under congestion – specifies whether Class 0 messages are routed during congestion conditions. The values for this parameter are `yes` and `no`. This parameter can be specified for any type of mated application, but this parameter affects only the traffic for a dominant mated application. The default value for ANSI load shared mated applications is `yes`. The default value for ITU load shared mated applications is `no`.

`:srm` – Subsystem routing messages – defines whether subsystem routing messages (SBR, SNR) are transmitted between the mated applications. The values for this parameter are `yes` and `no`. The `srm=yes` parameter can be specified only for ANSI mated applications. This parameter affects traffic only on dominant and combined dominant/load shared mated applications. The default value for ANSI load shared mated applications is `yes`. The default value for ITU load shared mated applications is `no`.

A load shared mated application can contain up to 128 point codes and subsystems, a primary point code and subsystem, and up to 31 mated point codes and subsystems. When a new load shared mated application is added to the database, the first two entries, the primary point code and subsystem and a mate point code and subsystem are added using the `ent-map` command. All other mated point code and subsystem entries that are being assigned to the primary point code and subsystem are added to the load shared mated application using the `chg-map` command.

All the point codes and subsystems in a load shared mated application have the same relative cost value. Traffic is shared equally between the point codes and subsystems in this mated application.

If the Flexible GTT Load Sharing feature is not enabled, the primary point code and subsystem number or the mate point code and mate subsystem number combination can be in the database only once. If the Flexible GTT Load Sharing feature is enabled, the primary point code and subsystem number or mate point code and mate subsystem number combination can be in multiple MAP sets, but can be in the default MAP set only once.. Refer to the [Provisioning a MAP Set](#) section for information on provisioning MAP sets.

The point codes specified in the `ent-map` or `chg-map` commands (`pc/pca`, `pci`, `pcn`, or `pcn24`, and `mpc/mpca`, `mpci`, `mpcn`, or `mpcn24`) must be either a full point code in the routing point code table. Cluster point codes or network routing point codes cannot be specified with this command. The `rtrv-rte` command can be used to verify the point codes in the routing table. The point codes in the routing table are shown in the `DPCA`, `DPCI`, `DPCN`, or `DPCN24` fields of the `rtrv-rte` command output.

The EAGLE's true point code, shown in the PCA, PCI, PCN, or PCN24 fields of the `rtrv-sid` command output, cannot be specified for a load shared mated application.

A load shared mated application can be provisioned with a point code that is assigned to other mated applications as long as the SSN is not assigned to other mated applications. A point code can be assigned to maximum of 12 different SSNs.

For mated applications containing ANSI or 24-bit ITU-N point codes, or the EAGLE's true point code, the format of the point codes specified in the `ent-map` command must be the same. For example, if the primary point code is a 24-bit ITU-N point code (`pcn24`), the mate point code must be a 24-bit ITU-N point code (`mpcn24`). The mate point codes of mated applications containing either ITU-I, ITU-I spare, 14-bit ITU-N, or 14-bit ITU-N spare primary point codes do not have to be the same format as the primary point code. The mate point codes of these mated applications can be a mixture of ITU-I, ITU-I spare, 14-bit ITU-N, or 14-bit ITU-N spare point codes.

The format of the point codes in the CSPC group specified with the `grp` parameter must be the same as the primary point code specified with the `ent-map` command only if the ANSI/ITU SCCP Conversion feature is not enabled. If the ANSI/ITU SCCP Conversion feature is enabled, the CSPC group may contain a mixture of point code types (refer to the [Adding a Concerned Signaling Point Code](#) procedure), and the network type of the CSPC group can be different from the network type of the primary point code of the mated application. The status of the ANSI/ITU SCCP Conversion feature can be verified with the `rtrv-ctrl-feat` command.

The values for the primary point code and subsystem combination (`pc/ssn`) cannot be the same as the mated point code and subsystem combination (`mpc/mssn`). However, the primary and mated point codes can be the same as long as the subsystem numbers are different.

If a mate point code (`mpc/mpca/mpci/mpcn/mpcn24`) is specified, the `mssn` parameter must be specified.

If the `mssn` parameter is specified, the mate point code (`mpc/mpca/mpci/mpcn/mpcn24`) must be specified.

If the `grp`, `srn`, `mrc`, and `ssn` parameter values are specified, and the specified point code and SSN is assigned to multiple mated applications, the `grp`, `srn`, `mrc`, and `ssn` values for all mated applications containing the specified point code and SSN will be changed to the values specified in this procedure.

The EAGLE can contain 1024, 2000, or 3000 mated applications. The EAGLE default is 1024 mated applications. This quantity can be increased to 2000 by enabling the feature access key for part number 893-0077-01, or to 3000 by enabling the feature access key for part number 893-0077-10. For more information on enabling these feature access keys, refer to the [Enabling the XMAP Table Expansion Feature](#) procedure.

Provisioning a MAP Set

The Flexible GTT Load Sharing feature provides the ability to define multiple load sharing sets in the MAP table where the same point code and subsystem can be assigned to different load sharing sets.

The MAP table contains specific load sharing sets, designated by numbers, and a default MAP set.

Flexible Final GTT Load Sharing provides flexible load sharing for global title translations defined in the GTT table and not for the MPS-based features. The MPS-

based features do not support the MAP set ID parameter. The MPS-based features perform lookups for load sharing in the default MAP set and the GTT table. The entries in the GTT table can be linked to a MAP set ID, allowing lookups in a specific MAP set other than the default MAP set.

Any MAP entries that were provisioned in the database before the Flexible GTT Load Sharing feature is enabled are placed in the default MAP set when the Flexible GTT Load Sharing feature is enabled.

To provision entries in the default MAP set, the `mapset=dflt` parameter must be specified with the `ent-map` or `chg-map` commands.

To provision entries in an existing MAP set other than the default MAP set, the `mapset=<MAP set ID>` parameter must be specified with the `chg-map` command. Provisioning entries in an existing MAP set can be performed only with the `chg-map` command.

To provision entries in a new MAP set, the `mapset=new` parameter must be specified with the `ent-map` command. The `mapset=new` parameter can be specified only with the `ent-map` command. When the `ent-map` command is executed with the `mapset=new` parameter, the new MAP set ID is automatically generated and displayed in the output of the `ent-map` command as follows.

```
New MAPSET Created : MAPSETID = <new MAP set ID>
```

A MAP set, other than the default MAP set, is a MAP group provisioned with the MAP set ID and can contain a maximum of 128 point codes.

The default MAP set can contain multiple MAP groups. The point code and subsystem number combination can appear only once in the default MAP set. The point code can appear in multiple MAP groups in the default MAP set with different subsystem numbers.

The point code and subsystem number combination provisioned in a MAP set can be provisioned in multiple MAP sets. All the point codes in a MAP set must be different.

Provisioning Weights and In-Service Thresholds for Mated Applications

Weighted GTT Load Sharing allows unequal traffic loads to be provisioned in MAP load sharing groups or MAP load sharing sets. This feature also allows provisioning control over load sharing groups or sets so that if insufficient capacity within the load sharing group or set is available, the load sharing group or set is not used.

To provision the weight values and in-service threshold values for MAP groups or MAP sets in this procedure, the `wt`, `mwt`, and `thr` parameters are used.

The `wt`, `mwt`, and `thr` parameters can be used only:

- If the MAP group or MAP set is either a load shared or combined dominant/load shared MAP group or MAP set.
- If the Weighted GTT Load Sharing feature is enabled and turned on.

The status of the Weighted GTT Load Sharing feature can be verified by entering the `rtrv-ctrl-feat` command. If the Weighted GTT Load Sharing feature is not enabled or not turned on, perform the [Activating the Weighted GTT Load Sharing Feature](#) procedure to enable and turn on the Weighted GTT Load Sharing feature.

If either the `wt` or `mwt` parameters are specified with the `ent-map` command, both parameters must be specified with the `ent-map` command.

To assign an in-service threshold value to the entries of a MAP group or MAP set that contains the point code value specified in the `ent-map` command, use the `thr` parameter with the `wt` and `mwt` parameters. When the `thr` parameter is specified with the `ent-map` command, the in-service threshold value is assigned to both entries specified in the `ent-map` command. The `thr` parameter cannot be specified with the `chg-map` command when adding additional entries to the MAP group or MAP set. When additional entries are added to the MAP group or MAP set with the `chg-map` command, the `thr` value that was specified in the `ent-map` command is assigned to the additional entries. For information on using the `thr` parameter with the `chg-map` command, refer to the [Changing the Weight and In-Service Threshold Values of a Mated Application](#) procedure.

The `thr` parameter does not have to be specified with the `ent-map` command. If the `thr` parameter is not specified with the `ent-map` command, the `THR` parameter value for the MAP group or MAP set is set to 1.

Specifying the `wt` and `mwt` parameters assigns a weight value to the point codes specified in the `ent-map` command. The `wt` parameter value is assigned to the `mpc/mpca/mpci/mpcn/mpcn24` parameter value and the `mwt` parameter value is assigned to the `mpc/mpca/mpci/mpcn/mpcn24` parameter value.

When additional entries are added to the MAP group or MAP set with the `chg-map` command, and the MAP group or MAP set entries have weight and in-service threshold values assigned, a weight value must be assigned to the `mpc/mpca/mpci/mpcn/mpcn24` parameter value using the `mwt` parameter.

The `wt` parameter does not have to be specified with the `chg-map` command. If the `wt` parameter is specified with the `chg-map` command, the weight value for the `pc/pca/pci/pcn/pcn24` parameter is not changed.

If the `wt` parameter is specified with the `chg-map` command and the `wt` value is the same as the value currently assigned to the `pc/pca/pci/pcn/pcn24` parameter, the weight value for the `pc/pca/pci/pcn/pcn24` parameter is not changed.

If the `wt` parameter is specified with the `chg-map` command and the `wt` value is different from the value currently assigned to the `pc/pca/pci/pcn/pcn24` parameter, the weight value for the `pc/pca/pci/pcn/pcn24` parameter is changed to the new `wt` value.

The weight values assigned to the entries in the MAP group or MAP set are shown in the `WT` column in the `rtrv-map` output.

The in-service threshold values assigned to the entries in the MAP group or MAP set are shown in the `THR` column in the `rtrv-map` output.

The `%WT` column in the `rtrv-map` output shows the percentage of the traffic the particular entry in the MAP group or MAP set will handle.

The `WT`, `%WT`, and `THR` columns are shown in the `rtrv-map` output only if the Weighted GTT Load Sharing feature is enabled and turned on.

For more information on the Weighted GTT Load Sharing feature, refer to the [Weighted GTT Load Sharing](#) section.

Canceling the `RTRV-MAP` Command

Because the `rtrv-map` command used in this procedure can output information for a long period of time, the `rtrv-map` command can be canceled and the output to the terminal stopped. There are three ways that the `rtrv-map` command can be canceled.

- Press the F9 function key on the keyboard at the terminal where the `rtrv-map` command was entered.
- Enter the `canc-cmd` without the `trm` parameter at the terminal where the `rtrv-map` command was entered.
- Enter the `canc-cmd:trm=<xx>`, where `<xx>` is the terminal where the `rtrv-map` command was entered, from another terminal other than the terminal where the `rtrv-map` command was entered. To enter the `canc-cmd:trm=<xx>` command, the terminal must allow Security Administration commands to be entered from it and the user must be allowed to enter Security Administration commands. The terminal's permissions can be verified with the `rtrv-secu-trm` command. The user's permissions can be verified with the `rtrv-user` or `rtrv-secu-user` commands.

For more information about the `canc-cmd` command, refer to *Commands User's Guide*.

1. Display the mated applications in the database using the `rtrv-map` command.

This is an example of the possible output.

```
rlghncxa03w 09-07-07 00:34:31 GMT EAGLE5 41.1.0

MAPSET ID=DFLT
PCA           Mate PCA           SSN RC MULT SRM MRC GRP NAME SSO
255-001-000           250 10  SOL *Y *Y  grp01  ON

MAPSET ID=1
PCA           Mate PCA           SSN RC MULT SRM MRC GRP NAME SSO
255-001-000           251 10  SHR *Y *Y  grp01  OFF
                253-001-002  254 10  SHR *Y *Y  grp01  OFF

MAPSET ID=2
PCA           Mate PCA           SSN RC MULT SRM MRC GRP NAME SSO
255-001-000           252 10  SOL *Y *Y  grp01  ON

MAPSET ID=DFLT
PCA           Mate PCA           SSN RC MULT SRM MRC GRP NAME SSO
255-001-000           253 10  SHR *Y *Y  grp01  OFF
                253-001-004  254 10  SHR *Y *Y  grp01  OFF

MAPSET ID=3
PCA           Mate PCA           SSN RC MULT SRM MRC GRP NAME SSO
255-001-001           255 10  DOM YES YES grp01  ON
                253-001-005  254 20  DOM YES YES grp01  ON

MAPSET ID=4
PCA           Mate PCA           SSN RC MULT SRM MRC GRP NAME SSO
255-001-001           250 10  DOM YES YES grp01  OFF
                253-001-001  254 20  DOM YES YES grp01  OFF
```



```

MAPSET ID=DFLT
PCA           Mate PCA           SSN RC MULT SRM MRC GRP NAME SSO
255-001-002   255-001-002   251 10  SHR *Y  *Y  grp01  OFF
                255-001-002   254 10  SHR *Y  *Y  grp01  OFF

MAPSET ID=5
PCA           Mate PCA           SSN RC MULT SRM MRC GRP NAME SSO
255-001-002   255-001-003   252 10  DOM YES YES  grp01  ON
                255-001-003   254 20  DOM YES YES  grp01  ON

MAPSET ID=6
PCA           Mate PCA           SSN RC MULT SRM MRC GRP NAME SSO
255-001-002   255-001-004   253 10  SHR *Y  *Y  grp01  ON
                255-001-004   254 10  SHR *Y  *Y  grp01  ON

MAPSET ID=7
PCA           Mate PCA           SSN RC MULT SRM MRC GRP NAME SSO
002-002-007   002-002-008   50 10  COM YES *Y  grp01  OFF
                002-002-008   30 10  COM YES *Y  grp01  OFF
                002-002-009   30 10  COM YES *Y  grp01  OFF
                002-002-010   30 20  COM YES *Y  grp01  OFF
                002-002-011   30 20  COM YES *Y  grp01  OFF

MAPSET ID=8
PCI           Mate PCI           SSN RC MULT SRM MRC GRP NAME SSO
2-001-2       2-001-1       255 10  DOM NO  YES  grp03  OFF
                2-001-1       254 20  DOM NO  YES  grp03  OFF

MAPSET ID=9
PCN           Mate PCN           SSN RC MULT SRM MRC GRP NAME SSO
00347        01387         253 10  SHR *N  *N  grp05  OFF
                01387         254 10  SHR *N  *N  grp05  OFF

MAP TABLE IS (25 of 36000) 1 % FULL

```

If any of the following items are not shown in the `rtrv-map` output, then the feature corresponding to these items is not enabled, or turned on if required.

- The `MAPSET` field - the Flexible GTT Load Sharing feature is not enabled.
- The `MRNSET` and `MRNPC` fields - the GTT Load Sharing with Alternate Routing Indicator feature is not enabled.
- The `WT`, `%WT`, `THR` columns - the Weighted GTT Load Sharing feature is not enabled and turned on.

If the maximum number of mated applications shown in the `rtrv-map` output in [1](#) is 1024, 2000, or 3000, continue the procedure with [3](#).

2. If the maximum number of mated applications shown in the `rtrv-map` output in [1](#) is 36000, the Flexible GTT Load Sharing feature is enabled.

Although the `rtrv-map` output shows there can be 36000 entries, a maximum of 1024, 2000, or 3000 different point codes (depending on whether the XMAP Table Expansion feature is enabled for 2000 or 3000 mated applications) can be provisioned for mated applications. To verify the number of different point codes

that can be provisioned for mated applications, enter the `rtrv-tbl-capacity` command. The following is an example of the possible output.

```
rlghncxa03w 06-10-28 21:15:37 GMT EAGLE5 36.0.0
```

```
MAP table is (3000 of 3000) 100% full
```

 **Note:**

The `rtrv-tbl-capacity` command output contains other fields that are not used by this procedure. If you wish to see all the fields displayed by the `rtrv-tbl-capacity` command, see the `rtrv-tbl-capacity` command description in *Commands User's Guide*.

3. Continue the procedure by performing one of these steps.
 - If the `rtrv-map` output in 1 or the `rtrv-tbl-capacity` output in 2 shows that the maximum number of mated applications is 3000, and the current number of provisioned mated applications is 3000, no new point codes can be used to provision mated applications. Continue the procedure with 4.
 - If the If the `rtrv-map` output in 1 or the `rtrv-tbl-capacity` output in 2 shows that the maximum number of mated applications is either 1024 or 2000, and the mated application being added increases the number beyond 1024 or 2000, perform [Enabling the XMAP Table Expansion Feature](#) to enable a greater quantity of mated applications. After the quantity of mated applications has been increased, continue the procedure with 4. If the maximum number of mated applications is not increased, no new point codes can be used to provision mated applications.
 - If the `rtrv-map` output in 1 or the `rtrv-tbl-capacity` output in 2 shows that the maximum number of mated applications is either 1024, 2000, or 3000 and the mated application being added will not increase the number beyond the quantity shown in the `rtrv-map` output in 1 or the `rtrv-tbl-capacity` output in 2, continue the procedure with 4.
4. A MAP group, without the Flexible GTT Load Sharing feature enabled, a MAP set, other than the default MAP set, and a MAP group contained in the default MAP set can contain a maximum of 128 entries.

Verify the number of entries that the MAP group or MAP set contains by entering the `rtrv-map` command with the primary point code and SSN assigned to the MAP group or MAP set. If the Flexible GTT Load Sharing feature is enabled, the `mapset` parameter and MAP set ID of the MAP set that the new mated application will be added to.

If the specified MAP set is not the default MAP set, only the `mapset` parameter needs to be specified with the `rtrv-map` command. The point code and SSN does not need to be specified. For this example, enter one of these commands.

```
rtrv-map:pca=002-002-007:ssn=50
```

The following is an example of the possible output.

```
rlghncxa03w 09-07-07 00:34:31 GMT EAGLE5 41.1.0
```

```
PCA          Mate PCA      SSN RC MULT SRM MRC GRP NAME SSO
002-002-007          50 10  COM YES *Y  grp01  OFF
                002-002-008  30 10  COM YES *Y  grp01  OFF
                002-002-009  30 10  COM YES *Y  grp01  OFF
                002-002-010  30 20  COM YES *Y  grp01  OFF
                002-002-011  30 20  COM YES *Y  grp01  OFF
```

MAP TABLE IS (25 of 1024) 2 % FULL

rtrv-map:pca=002-002-007:ssn=50:mapset=dflt

The following is an example of the possible output.

rlghncxa03w 09-07-07 00:34:31 GMT EAGLE5 41.1.0

MAPSET ID=DFLT

```
PCA          Mate PCA      SSN RC MULT SRM MRC GRP NAME SSO
002-002-007          50 10  COM YES *Y  grp01  OFF
                002-002-008  30 10  COM YES *Y  grp01  OFF
                002-002-009  30 10  COM YES *Y  grp01  OFF
                002-002-010  30 20  COM YES *Y  grp01  OFF
                002-002-011  30 20  COM YES *Y  grp01  OFF
```

MAP TABLE IS (25 of 36000) 1 % FULL

rtrv-map:mapset=7

The following is an example of the possible output.

rlghncxa03w 09-07-07 00:34:31 GMT EAGLE5 41.1.0

MAPSET ID=7

```
PCA          Mate PCA      SSN RC MULT SRM MRC GRP NAME SSO
002-002-007          50 10  COM YES *Y  grp01  OFF
                002-002-008  30 10  COM YES *Y  grp01  OFF
                002-002-009  30 10  COM YES *Y  grp01  OFF
                002-002-010  30 20  COM YES *Y  grp01  OFF
                002-002-011  30 20  COM YES *Y  grp01  OFF
```

MAP TABLE IS (25 of 36000) 1 % FULL

If the MAP group or MAP set contains 128 entries, no more entries can be added to the specified MAP group or MAP set. One of these actions can be performed.

- Entries can be added another MAP group or MAP set. Repeat this step for the other MAP group or MAP set.
- Entries can be removed from the specified MAP group or MAP set. To remove entries from the specified MAP group or MAP set, perform [Removing a Mated Application](#).
- Entries can be added to a new MAP group or MAP set.

 **Note:**

If none of these actions will be performed, then this procedure cannot be performed.

If the MAP group or MAP set contains less than 128 entries, entries can be added to the MAP group or MAP set.

After it has been determined which MAP group or MAP set that the new entries will be added to (a new MAP group or MAP set or an existing MAP group or MAP set), continue the procedure by performing one of these steps.

- If an existing point code is being added to this MAP group or MAP set, continue the procedure with 5.
 - If a new point code is being added to this MAP group or MAP set, continue the procedure by performing one of these steps.
 - If a concerned signaling point code (CSPC) group is not being assigned to the mated application, continue the procedure with 8. If the mated point code is not assigned to a CSPC group, that point code will not be notified of the subsystem's status.
 - If a concerned signaling point code (CSPC) group will be assigned to the mated application, continue the procedure with 6.
5. A mated application can be provisioned with a point code that is assigned to other mated applications as long as the SSN is not assigned to other mated applications.

A point code can be assigned to maximum of 12 different SSNs.

Verify the number of SSNs assigned to the point code that will be specified for the mated application in this procedure by entering the `rtrv-map` command with the point code of the new mated application. For this example, enter this command.

```
rtrv-map:pca=255-001-000
```

This is an example of the possible output.

```
rlghncxa03w 09-07-07 00:34:31 GMT EAGLE5 41.1.0

PCA           Mate PCA      SSN RC  MULT SRM  MRC  GRP  NAME  SSO
255-001-000           250 10  SOL  *Y   *Y   grp01  ON
255-001-000           251 10  SHR  *Y   *Y   grp01  OFF
                253-001-002 254 10  SHR  *Y   *Y   grp01  OFF
255-001-000           252 10  SOL  *Y   *Y   grp01  ON
255-001-000           253 10  SHR  *Y   *Y   grp01  OFF
                253-001-004 254 10  SHR  *Y   *Y   grp01  OFF

MAP TABLE IS (25 of 1024) 2 % FULL
```

If the Flexible GTT Load Sharing feature is enabled, the MAPSET IDs for the mated applications are shown in the `rtrv-map` output.

If the Weighted GTT Load Sharing feature is enabled and turned on, the WT, %WT, and THR columns are shown in the `rtrv-map` output.

If the point code is assigned to 12 different SSNs, and neither an existing point code in the `rtrv-map` output nor a new point code will be used to provision the mated application, then this procedure cannot be performed.

If the point code is assigned to less than 12 different SSNs, then the existing point code in the `rtrv-map` output can be used to provision the mated application.

If the point code is assigned to 12 different SSNs, another existing point code in the `rtrv-map` output or a new point code must be used to provision the mated application. If an existing point code in the `rtrv-map` output will be used to provision the mated application, repeat this step for that point code.

After it has been determined which point code will be used to provision the mated application (a new point code or an existing point code), continue the procedure by performing one of these steps.

- If a concerned signaling point code (CSPC) group is not being assigned to the mated application, continue the procedure with 8. If the mated point code is not assigned to a CSPC group, that point code will not be notified of the subsystem's status.
 - If a concerned signaling point code (CSPC) group will be assigned to the mated application, continue the procedure with 6.
6. Display the point codes in the CSPC group that you wish to assign to the mated application by first entering the `rtrv-cspc` command with no parameters.

This is an example of the possible output.

```
rlghncxa03w 06-10-25 09:48:31 GMT EAGLE5 36.0.0
CSPC GRP NETWORK PERCENT FULL
grp01 ANSI 6%
grp02 ITU-I 9%
grp03 ITU-N 12%
grp04 ANSI 15%
grp05 ANSI 15%
grp10 ANSI 15%
grp15 ANSI 15%
```

If the desired CSPC group is shown in the `rtrv-cspc` output, re-enter the `rtrv-cspc` command with the CSPC group name. For this example, enter these commands.`rtrv-cspc:grp=grp05`This is an example of the possible output.

```
rlghncxa03w 06-10-25 09:48:31 GMT EAGLE5 36.0.0
CSPC GRP PCA
grp05 005-005-005
      007-007-007
      008-008-008
      009-009-009

rtrv-cspc:grp=grp10
```

This is an example of the possible output.

```
rlghncxa03w 06-10-25 09:59:31 GMT EAGLE5 36.0.0
CSPC GRP      PCA
grp10         003-003-003
              004-004-004
              008-008-008
              009-009-009
```

```
rtrv-cspc:grp=grp15
```

This is an example of the possible output.

```
rlghncxa03w 06-10-25 09:48:31 GMT EAGLE5 36.0.0
CSPC GRP      PCA
grp15         005-005-005
              006-006-006
              008-008-008
              009-009-009
```

 **Note:**

If the ANSI/ITU SCCP Conversion feature is enabled, then point codes of multiple network types can be displayed in the `rtrv-cspc` output, if point codes of multiple network types are assigned to the CSPC group.

If the CSPC group is not in the database, or if the required point code is not assigned to the CSPC group, perform the [Adding a Concerned Signaling Point Code](#) procedure to add the required CSPC group or point code to the database.

 **Note:**

If the output of the `rtrv-cspc` command performed in [6](#) shows CSPC groups containing a mixture of point code types, or if the new CSPC group that was added in [6](#) contains a mixture of point code types, continue the procedure with [8](#).

7. The format of the point codes in the CSPC group specified with the `grp` parameter must be the same as the primary point code specified with the `ent-map` command only if the ANSI/ITU SCCP Conversion feature is not enabled.

If the ANSI/ITU SCCP Conversion feature is enabled, the CSPC group may contain a mixture of point code types (refer to the [Adding a Concerned Signaling Point Code](#) procedure), and the network type of the CSPC group can be different from the network type of the primary point code of the mated application.

Verify the status of the ANSI/ITU SCCP Conversion feature by entering this command.

```
rtrv-ctrl-feat:partnum=893012001
```

The following is an example of the possible output.

```
rlghncxa03w 06-10-28 21:15:37 GMT EAGLE5 36.0.0
```

The following features have been permanently enabled:

Feature Name	Partnum	Status	Quantity
SCCP Conversion	893012001	on	----

The following features have been temporarily enabled:

Feature Name	Partnum	Status	Quantity	Trial Period Left
Zero entries found.				

The following features have expired temporary keys:

Feature Name	Partnum
Zero entries found.	

If the ANSI/ITU SCCP Conversion feature is not enabled, perform the [Activating the ANSI/ITU SCCP Conversion Feature](#) procedure to enable the ANSI/ITU SCCP Conversion feature.

8. If the `MAPSET` column is shown in the `rtrv-map` output in [1](#), the Flexible GTT Load Sharing feature is enabled. Continue the procedure with [9](#).

If the `MAPSET` column is not shown in [1](#) and you do not wish to provision MAP sets in this procedure, continue the procedure with [9](#).

If the `MAPSET` column is not shown in [1](#) and you wish to provision MAP sets in this procedure, perform the [Activating the Flexible GTT Load Sharing Feature](#) procedure to enable the Flexible GTT Load Sharing feature. After the Flexible GTT Load Sharing feature is enabled, continue the procedure with [9](#).

 **Note:**

If you do not wish to assign weight and in-service threshold values to the MAP entries in the MAP group or MAP set, continue the procedure with [10](#).

9. If you wish to assign weight and in-service threshold values to the entries in the MAP group or MAP set, and the `WT`, `%WT`, and `THR` columns are shown in the `rtrv-map` output in [1](#), then the Weighted GTT Load Sharing feature is enabled and turned on.

If the `WT`, `%WT`, and `THR` columns are not shown in the `rtrv-map` output in [1](#), perform the [Activating the Weighted GTT Load Sharing Feature](#) procedure to enable and turn on the Weighted GTT Load Sharing feature.

If the Weighted GTT Load Sharing feature is enabled and turned on, or the [Activating the Weighted GTT Load Sharing Feature](#) procedure was performed in this step, continue this procedure by performing one of these steps.

- If only one of the point codes that will be specified for the mated application is assigned to other mated applications, perform [10](#) for the new point code that is not assigned to other mated applications.

- If the both point codes that will be specified for the mated application are point codes assigned to other mated applications, continue the procedure by performing one of these steps.
 - If the `mrnset` and `mrnpc` parameters will be specified for the mated application, continue the procedure with 13.
 - If the `mrnset` and `mrnpc` parameters will not be specified for the mated application, continue the procedure by performing one of these steps.
 - * If a new mated application is being added, continue the procedure with 14.
 - * If an entry is being added to an existing mated application, continue the procedure with 15.
10. Display the destination point codes in the database by entering the `rtrv-dstn` command. This is an example of the possible output.

```
rlghncxa03w 10-12-10 11:43:04 GMT EAGLE5 43.0.0
Extended Processing Time may be Required
```

```

      DPCA          CLLI          BEI ELEI  ALIASI
ALIASN/N24  DMN
  001-207-000  ----- no  --- -----
-----
                SS7
  001-001-001  ----- no  --- -----
-----
                SS7
  001-001-002  ----- no  --- -----
-----
                SS7
  001-005-000  ----- no  --- -----
-----
                SS7
  001-007-000  ----- no  --- -----
-----
                SS7
  008-012-003  ----- no  --- -----
-----
                SS7
  003-002-004  ----- no  --- -----
-----
                SS7
  009-002-003  ----- no  --- -----
-----
                SS7
  010-020-005  ----- no  --- -----
-----
                SS7
```

```

      DPCI          CLLI          BEI ELEI  ALIASA
ALIASN/N24  DMN
   1-207-0    ----- no  --- -----
-----
                SS7
   0-015-0    ----- no  --- -----
-----
                SS7
   0-017-0    ----- no  --- -----
-----
                SS7
   1-011-1    ----- no  --- -----
-----
                SS7
   1-011-2    ----- no  --- -----
-----
                SS7
```



```
Destination table is (14 of 2000) 1% full
Alias table is (0 of 12000) 0% full
PPC table is (1 of 20) 5% full
```

If the required point code is not shown in the `rtrv-dstn` output, perform the "Adding a Destination Point Code" procedure in *Database Administration - SS7 User's Guide* to add the required point code. A proxy point code cannot be assigned to the point code.

After the new point code has been added, skip 11 and 12, and perform one of the Adding a Route procedures in *Database Administration - SS7 User's Guide* and add the required route to the database. After the route has been added, continue the procedure by performing one of these steps.

- If the `mrnset` and `mrnpc` parameters will be specified for the mated application, continue the procedure with 13.
 - If the `mrnset` and `mrnpc` parameters will not be specified for the mated application, continue the procedure by performing one of these steps.
 - If a new mated application is being added, continue the procedure with 14.
 - If an entry is being added to an existing mated application, continue the procedure with 15.
11. Display the point code that will be assigned to the mated application by using the `rtrv-dstn` command and specifying the point code. For this example, enter this command.

```
rtrv-dstn:dpca=010-020-005
```

This is an example of the possible output.

```
rlghncxa03w 10-12-10 11:43:04 GMT EAGLE5 43.0.0
```

DPCA	CLLI	BEI	ELEI	ALIASI					
ALIASN/N24	DMN								
010-020-005	-----	no	---	-----					
-----	SS7								
PPCA	NCAI	PRX	RCAUSE	NPRST	SPLITIAM	HMSMSC	HMSCP		
SCCPMSGCNV									
009-002-003	----	no	50	on	20	no	no	none	

```
Destination table is (14 of 2000) 1% full
Alias table is (0 of 12000) 0% full
PPC table is (1 of 20) 5% full
```

If the point code is not shown in the `rtrv-dstn` command output, the following output is displayed.

```
rlghncxa03w 09-05-10 11:43:04 GMT EAGLE5 41.0.0
```

No destinations meeting the requested criteria were found

```
Destination table is (14 of 2000) 1% full
```

```
Alias table is (0 of 12000) 0% full
PPC table is (1 of 20) 5% full
```

A proxy point code (a point code value is shown in the PPC column) cannot be assigned to the point code. If a proxy point code is shown in this step, choose another point code from the `rtrv-dstn` output in the previous step and repeat this step.

After the new point code has been added, skip 12 and perform one of the Adding a Route procedures in *Database Administration - SS7 User's Guide* and add the required route to the database. After the route has been added, continue the procedure by performing one of these steps.

- If the `mrnset` and `mrnpc` parameters will be specified for the mated application, continue the procedure with 13.
- If the `mrnset` and `mrnpc` parameters will not be specified for the mated application, continue the procedure by performing one of these steps.
 - If a new mated application is being added, continue the procedure with 14.
 - If an entry is being added to an existing mated application, continue the procedure with 15.

12. Enter the `rtrv-rte` command with the `dpc` parameter specifying the point codes to be used with the `ent-map` or `chg-map` commands to verify whether or not the point code is the DPC of a route.

For this example, enter these commands.

```
rtrv-rte:dPCA=008-008-008
```

This is an example of the possible output.

```
rlghncxa03w 06-10-07 11:43:04 GMT EAGLE5 36.0.0
  DPCA          ALIASI      ALIASN/N24   LSN          RC          APCA
  008-008-008  -----  -----    ls20         10
008-008-008
                                           RTX:No  CLLI=ls20clli
```

```
rtrv-rte:dPCA=031-049-100
```

This is an example of the possible output.

```
rlghncxa03w 06-10-07 11:43:04 GMT EAGLE5 36.0.0
  DPCA          ALIASI      ALIASN/N24   LSN          RC          APCA
  031-049-100  -----  -----    ls10         10
031-049-100
                                           RTX:No  CLLI=ls10clli
```

```
rtrv-rte:dPCA=056-113-200
```

This is an example of the possible output.

```
rlghncxa03w 06-10-07 11:43:04 GMT EAGLE5 36.0.0
  DPCA          ALIASI      ALIASN/N24   LSN          RC          APCA
  056-113-200  -----  -----    ls12         10
```

056-113-200

RTX:No CLLI=ls12clli

rtrv-rte:dpca=179-183-050

This is an example of the possible output.

```
rlghncxa03w 06-10-07 11:43:04 GMT EAGLE5 36.0.0
  DPCA          ALIASI      ALIASN/N24   LSN      RC      APCA
  179-183-050  -----
179-183-050
```

RTX:No CLLI=ls18clli

rtrv-rte:dpca=002-002-002

This is an example of the possible output.

```
rlghncxa03w 06-10-07 11:43:04 GMT EAGLE5 36.0.0
  DPCA          ALIASI      ALIASN/N24   LSN      RC      APCA
  002-002-002  -----
002-002-002
```

RTX:No CLLI=ls02clli

rtrv-rte:dpca=004-004-004

This is an example of the possible output.

```
rlghncxa03w 06-10-07 11:43:04 GMT EAGLE5 36.0.0
  DPCA          ALIASI      ALIASN/N24   LSN      RC      APCA
  004-004-004  -----
004-004-004
```

RTX:No CLLI=ls04clli
RTX:No CLLI=ls13clli

rtrv-rte:dpca=068-135-094

This is an example of the possible output.

```
rlghncxa03w 06-10-07 11:43:04 GMT EAGLE5 36.0.0
  DPCA          ALIASI      ALIASN/N24   LSN      RC      APCA
  068-135-094  -----
068-135-094
```

RTX:No CLLI=ls14clli

rtrv-rte:dpca=100-100-100

This is an example of the possible output.

```
rlghncxa03w 06-10-07 11:43:04 GMT EAGLE5 36.0.0
  DPCA          ALIASI      ALIASN/N24   LSN      RC      APCA
  100-100-100  -----
100-100-100
```

RTX:No CLLI=ls16clli

```
rtrv-rte:dpca=100-130-079
```

This is an example of the possible output.

```
rlghncxa03w 06-10-07 11:43:04 GMT EAGLE5 36.0.0
  DPCA          ALIASI      ALIASN/N24    LSN          RC      APCA
  100-130-079  -----  -----      ls17         10
100-130-079
                                           RTX:No  CLLI=ls17clli
```

```
rtrv-rte:dpca=200-147-100
```

This is an example of the possible output.

```
rlghncxa03w 06-10-07 11:43:04 GMT EAGLE5 36.0.0
  DPCA          ALIASI      ALIASN/N24    LSN          RC      APCA
  200-147-100  -----  -----      ls19         10
200-147-100
                                           RTX:No  CLLI=ls19clli
```

If the point code is not shown in the `rtrv-rte` output, perform one of the Adding a Route procedures in *Database Administration - SS7 User's Guide* and add the required route to the database.

Continue the procedure by performing one of these steps.

- If the `mrnset` and `mrnpc` parameters will be specified for the mated application, continue the procedure with [13](#).
- If the `mrnset` and `mrnpc` parameters will not be specified for the mated application, continue the procedure by performing one of these steps.
 - If a new mated application is being added, continue the procedure with [14](#).
 - If an entry is being added to an existing mated application, continue the procedure with [15](#).

- 13.** The MRN point code value must be assigned to an MRN set. The MRN set must be shown in the `rtrv-mrn` output. Display the MRN sets by entering the `rtrv-mrn` command. This is an example of the possible output.

```
rlghncxa03w 09-02-07 00:34:31 GMT EAGLE5 40.1.0

  MRNSET MAPSET  MAPPK          MAPSSN      PC          RC WT
%WT THR
  DFLT   7      002-002-007      50         005-005-005  10 10
14   1
                                           006-001-001  10 10
14   1
                                           006-001-002  10 20
28   1
                                           006-001-003  10 30
42   1
                                           006-001-004  20 40
23   1
                                           006-001-005  20 40
23   1
```

					006-001-006	20	40
23	1						
					006-001-007	20	50
29	1						
		MRNSET	MAPSET	MAPPC	MAPSSN	PC	RC WT
		%WT	THR				
		1	-----	-----	---	007-007-007	10 10
14	1						
						008-001-001	10 10
14	1						
						008-001-002	10 20
28	1						
						008-001-003	10 30
42	1						
						008-001-004	20 40
23	1						
						008-001-005	20 40
23	1						
						008-001-006	20 40
23	1						
						008-001-007	20 50
29	1						

MRN table is (16 of 5990) 1% full

If any of the following items are not shown in the `rtrv-mrn` output, then the feature corresponding to these items is not enabled, or turned on if required.

- The `MRNSET` field - the Flexible GTT Load Sharing feature is not enabled.
- The `MAPSET`, `MAPPC` and `MAPSSN` fields - the GTT Load Sharing with Alternate Routing Indicator feature is not enabled.
- The `WT`, `%WT`, `THR` columns - the Weighted GTT Load Sharing feature is not enabled and turned on.

 **Note:**

The network type of the `pc/pca/pci/pcn/pcn24` and `mrnpc/mrnpca/mrnpai/mrnpai24` parameter values must be compatible, as shown in Note 7 in [Table 2-46](#) or in Note 8 in [Table 2-47](#).

If the MRN set that you wish to use, containing the desired point code, is not shown in the `rtrv-mrn` output, add the required MRN set by performing the [Provisioning MRN Entries](#) procedure.

If the MRN set that you wish to use is shown in the `rtrv-mrn` output, or the [Provisioning MRN Entries](#) procedure was performed in this step, continue the procedure by performing one of these steps.

- If a new mated application is being added, continue the procedure with [14](#).
- If an entry is being added to an existing mated application, continue the procedure with [15](#).

14. Add the mated application to the database using the `ent-map` command. Use [Table 2-46](#) as a guide for the parameters and values that can be specified with the `ent-map` command.

Table 2-46 Load Shared Mated Application Parameter Combinations for the ENT-MAP Command

Mandatory Parameters
<code>:pc/pca/pci/pcn/pcn24=<ANSI, ITU-I, ITU-I spare, ITU-N, ITU-N spare, or ITU-N24 point code from the rtrv-rte or rtrv-map outputs> (See Notes 5 and 7)</code>
<code>:ssn=<subsystem number, 2 - 255></code>
<code>:rc=<0 - 99> The <code>rc</code> and <code>materc</code> parameter values must be equal.</code>
<code>:mpc/mpca/mpci/mpcn/mpcn24=<ANSI, ITU-I, ITU-I spare, ITU-N, ITU-N spare, or ITU-N24 point code of the mate from the rtrv-rte or rtrv-map outputs> (See Notes 2, 5, and 7)</code>
<code>:mssn=<subsystem number of the mate, 2 - 255></code>
<code>:materc=<0 - 99> The <code>rc</code> and <code>materc</code> parameter values must be equal.</code>
Optional Parameters
<code>:wt=<1 - 99> (See Note 4)</code>
<code>:mwt=<1 - 99> (See Note 4)</code>
<code>:thr=<1 - 100> (See Note 4)</code>
<code>:grp=<CSPC group name> (See Note 1)</code>
<code>:sso=<on, off></code>
<code>:mapset=<new, dflt> (See Note 3)</code>
<code>:mrnset = <MRN set ID from the rtrv-mrn output> (See Note 6)</code>
<code>:mrnpc/mrnpca/mrnpai/mrnpai24=<the point code value in the MRN set> (See Notes 6 and 7)</code>
<code>:srm=<yes, no> (See Note 8)</code>
<code>:mrc=<yes, no> (See Note 8)</code>

Table 2-46 (Cont.) Load Shared Mated Application Parameter Combinations for the ENT-MAP Command

Notes:	
<p>a. The format of the point codes in the CSPC group specified with the <code>grp</code> parameter must be the same as the primary point code specified with the <code>ent-map</code> command only if the ANSI/ITU SCCP Conversion feature is not enabled. If the ANSI/ITU SCCP Conversion feature is enabled, the CSPC group may contain a mixture of point code types (refer to the Adding a Concerned Signaling Point Code procedure), and the network type of the CSPC group can be different from the network type of the primary point code of the mated application.</p> <p>b. For mated applications containing ANSI or 24-bit ITU-N point codes, the format of the point codes specified in the <code>ent-map</code> command must be the same. For example, if the primary point code is a 24-bit ITU-N point code (<code>pcn24</code>), the mate point code must be a 24-bit ITU-N point code (<code>mpcn24</code>). The mate point codes of mated applications containing either ITU-I, ITU-I spare, 14-bit ITU-N, or 14-bit ITU-N spare primary point codes do not have to be the same format as the primary point code. The mate point codes of these mated applications can be a mixture of ITU-I, ITU-I spare, 14-bit ITU-N, or 14-bit ITU-N spare point codes.</p> <p>c. If the Flexible GTT Load Sharing is enabled, the <code>mapset</code> parameter must be specified with the <code>ent-map</code> command. If the Flexible GTT Load Sharing is not enabled, the <code>mapset</code> parameter cannot be specified with the <code>ent-map</code> command.</p> <p>To provision entries in the default MAP set, the <code>mapset=dflt</code> parameter must be specified with the <code>ent-map</code> command.</p> <p>To provision entries in a new MAP set, the <code>mapset=new</code> parameter must be specified with the <code>ent-map</code> command. The <code>mapset=new</code> parameter can be specified only with the <code>ent-map</code> command. When the <code>ent-map</code> command is executed with the <code>mapset=new</code> parameter, the new MAP set ID is automatically generated and displayed in the output of the <code>ent-map</code> command as follows.</p> <pre>New MAPSET Created : MAPSETID = <new MAP set ID></pre> <p>A MAP set, other than the default MAP set, is a MAP group provisioned with the MAP set ID and can contain a maximum of 128 point code and subsystem entries. The default MAP set can contain multiple MAP groups. Each group in the default MAP set can contain a maximum of 128 point code and subsystem entries. The point code and subsystem entry can appear only once in the default MAP set, so the point code and subsystem entry can appear in only one MAP group in the default MAP set. The point code and subsystem entry provisioned in a MAP set can be provisioned in multiple MAP sets. If a point code and subsystem entry is provisioned in different MAP sets, the relative cost value of the entry in each MAP set can be different. All the point code and subsystem entries in a MAP set, including the default MAP set, must be different.</p> <p>d. Refer to the Provisioning Weights and In-Service Thresholds for Mated Applications section for information about using the weight (<code>wt</code> and <code>mwt</code>) and in-service threshold (<code>thr</code>) parameters.</p> <p>e. If the point code selected from either the <code>rtrv-rte</code> or <code>rtrv-map</code> outputs is a 14-bit ITU-N point code, then the <code>pcn/mpcn</code> parameters must be specified. If the point code selected from either the <code>rtrv-rte</code> or <code>rtrv-map</code> outputs is a 24-bit ITU-N point code, then the <code>pcn24/mpcn24</code> parameters must be specified.</p> <p>f. The <code>mrnset</code> and <code>mrnpc/mrnpca/mrnpca/mrnpca/mrnpca/mrnpca</code> parameters can be specified only if the GTT Load Sharing with Alternate Routing Indicator feature</p>	

Table 2-46 (Cont.) Load Shared Mated Application Parameter Combinations for the ENT-MAP Command

is enabled. Refer to the [Activating the GTT Load Sharing with Alternate Routing Indicator Feature](#) procedure for information about enabling the GTT Load Sharing with Alternate Routing Indicator feature. The `mrnset` and `mrnpc/mrnpca/mrnpci/mrnpn/mrnpn24` values must be shown in the `rtrv-mrn` output.

- g.** The network type of the `pc/pca/pci/pcn/pcn24` and `mrnpc/mrnpca/mrnpci/mrnpn/mrnpn24` parameter values must be compatible, as shown in [Table 2-45](#).
- h.** The `srn=yes` parameter can be specified only for load shared mated applications containing ANSI point codes, but this parameter affects traffic only on dominant and combined dominant/load shared mated applications. The `mrc` parameter can be specified for a load shared mated application, but this parameter affects traffic only for a dominant mated application. These are the default values for the `srn` and `mrc` parameters.
 - ANSI mated applications - `srn=yes, mrc=yes`
 - ITU mated applications - `srn=no, mrc=no`

If the Flexible GTT Load Sharing feature is not enabled for this example, enter these commands.

```
ent-
map:pca=004-004-004:ssn=254:rc=10:mpc=100-100-100:mssn=254 :m
aterc=10:grp=grp10:sso=off
```

```
ent-
map:pca=002-002-002:ssn=250:rc=10:mpc=100-130-079:mssn=250 :m
aterc=10:grp=grp15:sso=on:wt=10:mwt=10:thr=40
```

```
ent-
map:pca=008-008-008:ssn=254:rc=10:mpc=200-147-100:mssn=254 :m
aterc=10:grp=grp10:sso=on:wt=10:mwt=20
```

```
ent-
map:pci=5-005-5:ssn=50:rc=10:mpcn=0257:mssn=50:materc=10 :grp
=grp20:mrc=yes:sso=off
```

When each of these commands have successfully completed, this message should appear.

```
rlghncxa03w 06-10-07 11:44:13 GMT EAGLE5 36.0.0
ENT-MAP: MASP A - COMPLTD
```

If the Flexible GTT Load Sharing feature is enabled for this example, enter these commands.

```
ent-
map:pca=004-004-004:ssn=254:rc=10:mpc=100-100-100:mssn=254 :m
aterc=10:grp=grp10:sso=off:mapset=new
```

```
ent-
map:pca=002-002-002:ssn=250:rc=10:mpc=100-130-079:mssn=250 :m
aterc=10:grp=grp15:sso=on:mapset=df1t:wt=10:mwt=10:thr=40
```



```
ent-
map:pca=008-008-008:ssn=254:rc=10:mpc=200-147-100:mssn=254 :m
aterc=10:grp=grp10:sso=on:mapset=new:wt=10:mwt=20

ent-
map:pci=5-005-5:ssn=50:rc=10:mpcn=0257:mssn=50:materc=10 :grp
=grp20:mrc=yes:sso=off:mapset=new
```

If the GTT Load Sharing with Alternate Routing Indicator feature is enabled for this example, enter these commands.

```
ent-
map:pca=004-004-004:ssn=254:rc=10:mpc=100-100-100:mssn=254 :m
aterc=10:grp=grp10:sso=off:mapset=new:mrnset=df1t:mrnpc=005-0
05-005

ent-
map:pca=002-002-002:ssn=250:rc=10:mpc=100-130-079:mssn=250 :m
aterc=10:grp=grp15:sso=on:mapset=df1t:wt=10:mwt=10:thr=40:mrn
set=1 :mrnpc= 007-007-007
```

If the Flexible GTT Load Sharing feature is enabled when each of these commands have successfully completed, and a new MAP set was created, a message similar to the following should appear.

```
rlghncxa03w 06-10-07 11:44:13 GMT EAGLE5 36.0.0
New MAPSET Created : MAPSETID = 9
ENT-MAP: MASP A - COMPLTD
```

If the Flexible GTT Load Sharing feature is enabled when each of these commands have successfully completed, and the mated application was added to the default MAP set, this message should appear.

```
rlghncxa03w 06-10-07 11:44:13 GMT EAGLE5 36.0.0
ENT-MAP: MASP A - COMPLTD
```

If no other entries are being added to the mated application, continue the procedure with [16](#).

If other entries are being added to the mated application, continue the procedure with [15](#).

15. Add the mated point code and subsystem to the mated application using the `chg-map` command. Use [Table 2-47](#) as a guide for the parameters and values that can be specified with the `chg-map` command.

Table 2-47 Load Shared Mated Application Parameter Combinations for the CHG-MAP Command

Mandatory Parameters
:pc/pca/pci/pcn/pcn24=<ANSI, ITU-I, ITU-I spare, ITU-N, ITU-N spare, or ITU-N24 point code from the <code>rtrv-rte</code> or <code>rtrv-map</code> outputs> (See Notes 5 and 8)
:ssn=<subsystem number>
:mpc/mpca/mpci/mpcn/mpcn24=<ANSI, ITU-I, ITU-I spare, ITU-N, ITU-N spare, or ITU-N24 point code of the mate from the <code>rtrv-rte</code> or <code>rtrv-map</code> outputs> (See Notes 2, 5, and 8)
:mssn=<subsystem number of the mate, 2 - 255>

Table 2-47 (Cont.) Load Shared Mated Application Parameter Combinations for the CHG-MAP Command

:materc=<0 - 99> The `rc` and `materc` parameter values must be equal.

Optional Parameters

:wt=<1 - 99> (See Note 4)

:mwt=<1 - 99> (See Note 4)

:grp=<CSPC group name> (See Notes 1 and 6)

:sso=<on, off> (See Note 6)

:mapset=<dflt or the number of an existing MAP set> (See Note 3)

:mrnset = <MRN set ID from the `rtv-mrn` output> (See Note 7)

:mrnpc/mrnpca/mrnpai/mrnpai24=<the point code value in the MRN set> (See Notes 7 and 8)

:srm=<yes, no> (See Notes 6 and 9)

:mrc=<yes, no> (See Notes 6 and 9)

Table 2-47 (Cont.) Load Shared Mated Application Parameter Combinations for the CHG-MAP Command

Notes	
a.	<p>The format of the point codes in the CSPC group specified with the <code>grp</code> parameter must be the same as the primary point code specified with the <code>chg-map</code> command only if the ANSI/ITU SCCP Conversion feature is not enabled. If the ANSI/ITU SCCP Conversion feature is enabled, the CSPC group may contain a mixture of point code types (refer to the Adding a Concerned Signaling Point Code procedure), and the network type of the CSPC group can be different from the network type of the primary point code of the mated application.</p>
b.	<p>For mated applications containing ANSI or 24-bit ITU-N point codes, the format of the point codes specified in the <code>chg-map</code> command must be the same. For example, if the primary point code is a 24-bit ITU-N point code (<code>pcn24</code>), the mate point code must be a 24-bit ITU-N point code (<code>mpcn24</code>). The mate point codes of mated applications containing either ITU-I, ITU-I spare, 14-bit ITU-N, or 14-bit ITU-N spare primary point codes do not have to be the same format as the primary point code. The mate point codes of these mated applications can be a mixture of ITU-I, ITU-I spare, 14-bit ITU-N, or 14-bit ITU-N spare point codes.</p>
c.	<p>If the Flexible GTT Load Sharing is enabled, the <code>mapset</code> parameter must be specified with the <code>chg-map</code> command. If the Flexible GTT Load Sharing is not enabled, the <code>mapset</code> parameter cannot be specified with the <code>chg-map</code> command.</p> <p>To provision entries in the default MAP set, the <code>mapset=dflt</code> parameter must be specified with the <code>chg-map</code> command.</p> <p>To provision entries in an existing MAP set, the <code>mapset</code> parameter must be specified with the MAP set ID value of that MAP set.</p> <p>A MAP set, other than the default MAP set, is a MAP group provisioned with the MAP set ID and can contain a maximum of 128 point code and subsystem entries.</p> <p>The default MAP set can contain multiple MAP groups. Each group in the default MAP set can contain a maximum of 128 point code and subsystem entries.</p> <p>The point code and subsystem entry can appear only once in the default MAP set, so the point code and subsystem entry can appear in only one MAP group in the default MAP set.</p> <p>The point code and subsystem entry provisioned in a MAP set can be provisioned in multiple MAP sets. If a point code and subsystem entry is provisioned in different MAP sets, the relative cost value of the entry in each MAP set can be different. All the point code and subsystem entries in a MAP set, including the default MAP set, must be different.</p>
d.	<p>Refer to the Provisioning Weights and In-Service Thresholds for Mated Applications section for information about using the <code>wt</code> and <code>mwt</code> parameters.</p>
e.	<p>If the point code selected from either the <code>rtrv-rte</code> or <code>rtrv-map</code> outputs is a 14-bit ITU-N point code, then the <code>pcn/mpcn</code> parameters must be specified. If the point code selected from either the <code>rtrv-rte</code> or <code>rtrv-map</code> outputs is a 24-bit ITU-N point code, then the <code>pcn24/mpcn24</code> parameters must be specified.</p>
f.	<p>The CSPC group name (<code>grp</code>) <code>srn</code>, <code>mrc</code>, or <code>ssn</code> values for a specific point code and SSN in a mated application are changed, these parameter values for this specific point code and SSN in all applicable mated applications will be changed to the new values.</p>
g.	<p>The <code>mrnset</code> and <code>mrnpc/mrnpca/mrnpai/mrnpai/mrnpai/mrnpai</code> parameters can be specified only if the GTT Load Sharing with Alternate Routing Indicator feature is enabled. Refer to the Activating the GTT Load Sharing with Alternate Routing Indicator Feature procedure for information about enabling the GTT Load Sharing</p>

Table 2-47 (Cont.) Load Shared Mated Application Parameter Combinations for the CHG-MAP Command

<p>with Alternate Routing Indicator feature. The <code>mrnset</code> and <code>mrnpc/mrnpca/mrnpai/mrnpai/mrnpai/mrnpai</code> values must be shown in the <code>rtrv-mrn</code> output.</p> <p>h. The network type of the <code>pc/pca/pci/pcn/pcn24</code> and <code>mrnpc/mrnpca/mrnpai/mrnpai/mrnpai/mrnpai</code> parameter values must be compatible, as shown in Table 2-45.</p> <p>i. The <code>srn=yes</code> parameter can be specified only for load shared mated applications containing ANSI point codes, but this parameter affects traffic only on dominant and combined dominant/load shared mated applications. The <code>mrc</code> parameter can be specified for a load shared mated application, but this parameter affects traffic only for a dominant mated application. These are the default values for the <code>srn</code> and <code>mrc</code> parameters.</p> <ul style="list-style-type: none"> • ANSI mated applications - <code>srn=yes, mrc=yes</code> • ITU mated applications - <code>srn=no, mrc=no</code>
--

If the Flexible GTT Load Sharing feature is not enabled for this example, enter these commands.

```
chg-
map:pca=002-002-002:ssn=250:mpca=068-135-094:mssn=251 :materc=
=10:grp=grp05:sso=off:mwt=20
```

```
chg-
map:pca=008-008-008:ssn=254:mpca=179-183-050:mssn=250 :materc=
=10:grp=grp15:sso=off:mwt=30
```

```
chg-
map:pca=008-008-008:ssn=254:mpca=031-049-100:mssn=250 :materc=
=10:grp=grp15:sso=on:mwt=40
```

```
chg-
map:pca=008-008-008:ssn=254:mpca=056-113-200:mssn=251 :materc=
=10:grp=grp05:sso=off:mwt=50
```

```
chg-
map:pca=255-001-000:ssn=251:mpca=255-001-001:mssn=56 :materc=
=10:grp=grp05:sso=off:wt=30:mwt=50
```

```
chg-
map:pci=5-005-5:ssn=50:rc=10:mpci=s-5-005-6:mssn=50:materc=10
:grp=grp20:mrc=yes:sso=off
```

```
chg-
map:pci=5-005-5:ssn=50:rc=10:mpci=5-005-1:mssn=50:materc=10 :
grp=grp20:mrc=yes:sso=off
```

When each of these commands have successfully completed, this message should appear.

```
rlghncxa03w 06-10-07 11:44:13 GMT EAGLE5 36.0.0
CHG-MAP: MASP A - COMPLTD
```

If the Flexible GTT Load Sharing feature is enabled for this example, enter these commands.

```
chg-
map:pca=002-002-002:ssn=250:mpca=068-135-094:mssn=251 :materc=
=10:grp=grp05:sso=off:mapset=df1t:mwt=20
```

```
chg-
map:pca=008-008-008:ssn=254:mpc=179-183-050:mssn=250 :materc=
10:grp=grp15:sso=off:mapset=12:mwt=30
```

```
chg-
map:pca=008-008-008:ssn=254:mpca=031-049-100:mssn=250 :materc=
=10:grp=grp15:sso=on:mapset=13:mwt=40
```

```
chg-
map:pca=008-008-008:ssn=254:mpca=056-113-200:mssn=251 :materc=
=10:grp=grp05:sso=off:mapset=13:mwt=50
```

```
chg-
map:pca=255-001-000:ssn=251:mpca=255-001-001 :mssn=56:materc=
10:grp=grp05:sso=off:wt=30:mwt=50:mapset=1
```

```
chg-
map:pci=5-005-5:ssn=50:rc=10:mpci=s-5-005-6:mssn=50:materc=10
:grp=grp20:mrc=yes:sso=off:mapset=14
```

```
chg-
map:pci=5-005-5:ssn=50:rc=10:mpci=5-005-1:mssn=50:materc=10 :
grp=grp20:mrc=yes:sso=off:mapset=14
```

If the GTT Load Sharing with Alternate Routing Indicator feature is enabled for this example, and the `mrnset` and `mrnpc` parameters were not specified in 14, enter these commands.

```
chg-
map:pca=008-008-008:ssn=254:mpca=056-113-200:mssn=251 :materc=
=10:grp=grp05:sso=off:mapset=13:mwt=50:mrnset=1 :mrnpc=007-00
7-007
```

```
chg-
map:pca=255-001-000:ssn=251:mpca=255-001-001 :mssn=56:materc=
10:grp=grp05:sso=off:wt=30:mwt=50:mapset=1 :mrnset=df1t:mrnpc
=005-005-005
```

When each of these commands have successfully completed, this message should appear.

```
rlghncxa03w 06-10-07 11:44:13 GMT EAGLE5 36.0.0
CHG-MAP: MASP A - COMPLTD
```

Repeat this step for all new entries being added to the existing mated application.

If the Flexible GTT Load Sharing feature is not enabled, the mated application can contain a maximum of 128 entries.

If the Flexible GTT Load Sharing feature is enabled, and the MAP set is not the default MAP set, the MAP set can contain a maximum of 128 entries.

If the Flexible GTT Load Sharing feature is enabled, and the MAP set is the default MAP set, the default MAP set can contain multiple MAP groups. Each group in the default MAP set can contain a maximum of 128 point code and subsystem entries.

16. Verify the changes using the `rtrv-map` command with the primary point code and subsystem specified in 14 and 15.

If a new MAP set was created in 14, the `mapset` parameter should be specified with the `rtrv-map` command. The value for the `mapset` parameter should be the MAP set ID generated in 14.

If the mated application was added to an existing MAP set in 15, the `mapset` parameter and value specified in 15 should be specified with the `rtrv-map` command.

If the Flexible GTT Load Sharing feature is not enabled for this example, enter these commands.

```
rtrv-map:pca=004-004-004:ssn=254
```

This is an example of the possible output.

```
rlghncxa03w 09-07-07 00:34:31 GMT EAGLE5 41.1.0
```

PCA	Mate PCA	SSN	RC	MULT	SRM	MRC	GRP	NAME	SSO	WT	%WT
THR											
004-004-004		254	10	SHR	*Y	*Y	grp10		OFF	--	
---	--										
	100-100-100	254	10	SHR	*Y	*Y	grp10		OFF	--	
---	--										

```
MAP TABLE IS (37 of 1024) 4 % FULL
```

```
rtrv-map:pca=002-002-002:ssn=250
```

This is an example of the possible output.

```
rlghncxa03w 09-07-07 00:34:31 GMT EAGLE5 41.1.0
```

PCA	Mate PCA	SSN	RC	MULT	SRM	MRC	GRP	NAME	SSO	WT	%WT
THR											
002-002-002		250	10	SHR	*Y	*Y	grp15		ON	10	
50	40										
	100-130-079	250	10	SHR	*Y	*Y	grp15		ON	10	
50	40										
	068-135-094	251	10	SHR	*Y	*Y	grp05		OFF	20	
100	40										

```
MAP TABLE IS (37 of 1024) 4 % FULL
```

```
rtrv-map:pca=008-008-008:ssn=254
```

This is an example of the possible output.

```
rlghncxa03w 09-07-07 00:34:31 GMT EAGLE5 41.1.0
```

PCA	Mate PCA	SSN	RC	MULT	SRM	MRC	GRP	NAME	SSO	WT	%WT
THR											
008-008-008		254	10	SHR	*Y	*Y	grp10		ON	10	
6	1										
	200-147-100	254	10	SHR	*Y	*Y	grp10		ON	20	

```

13  1
      179-183-050  250 10  SHR *Y *Y  grp15  OFF 30
20  1
      031-049-100  250 10  SHR *Y *Y  grp15  ON  40
26  1
      056-113-200  251 10  SHR *Y *Y  grp05  OFF 50
33  1

```

MAP TABLE IS (37 of 1024) 4 % FULL

rtrv-map:pca=255-001-000:ssn=251

This is an example of the possible output.

rlghncxa03w 09-07-07 00:34:31 GMT EAGLE5 41.1.0

PCA	Mate	PCA	SSN	RC	MULT	SRM	MRC	GRP	NAME	SSO	WT	%WT
THR												
255-001-000			251	10	SHR	*Y	*Y	grp01		OFF	50	
55	20											
		253-001-002	254	10	SHR	*Y	*Y	grp01		OFF	10	
11	20											
		255-001-001	56	10	SHR	*Y	*Y	grp05		OFF	30	
33	20											

MAP TABLE IS (37 of 1024) 4 % FULL

rtrv-map:pci=5-005-5:ssn=50

This is an example of the possible output.

rlghncxa03w 09-07-07 00:34:31 GMT EAGLE5 41.1.0

PCI	NET	Mate	PC	SSN	RC	MULT	SRM	MRC	GRP	NAME	SSO	WT	%WT
THR													
5-005-5				50	10	SHR	*N	*N	grp20		OFF	--	
---	--												
	N	0257		50	10	SHR	*N	*N	grp20		OFF	--	
---	--												
	I	s-5-005-6		50	10	SHR	*N	*N	grp20		OFF	--	
---	--												
	I	5-005-1		50	10	SHR	*N	*N	grp20		OFF	--	
---	--												

MAP TABLE IS (37 of 1024) 4 % FULL

 **Note:**

If the Weighted GTT Load Sharing feature is not enabled or turned on, the WT, %WT, and THR columns are not shown in the rtrv-map output.

If the Flexible GTT Load Sharing feature is enabled for this example, enter these commands.

```
rtrv-map:pca=004-004-004:ssn=254:mapset=10
```

This is an example of the possible output.

```
rlghncxa03w 09-07-07 00:34:31 GMT EAGLE5 41.1.0
```

```
MAPSET ID=10      MRNSET=DFLT      MRNPC=005-005-005
PCA              Mate PCA      SSN RC MULT SRM MRC GRP NAME SSO WT
%WT THR
004-004-004          254 10  SHR *Y *Y  grp10   OFF --
--- --
                    100-100-100  254 10  SHR *Y *Y  grp10   OFF --
--- --
```

```
MAP TABLE IS (37 of 36000) 4 % FULL
```

```
rtrv-map:pca=002-002-002:ssn=250:mapset=dflt
```

This is an example of the possible output.

```
rlghncxa03w 09-07-07 00:34:31 GMT EAGLE5 41.1.0
```

```
MAPSET ID=DFLT   MRNSET=1      MRNPC=007-007-007
PCA              Mate PCA      SSN RC MULT SRM MRC GRP NAME SSO WT
%WT THR
002-002-002          250 10  SHR *Y *Y  grp15   ON  10
50  40
                    100-130-079  250 10  SHR *Y *Y  grp15   ON  10
50  40
                    068-135-094  251 10  SHR *Y *Y  grp05   OFF 20
100  40
```

```
MAP TABLE IS (37 of 36000) 4 % FULL
```

```
rtrv-map:pca=008-008-008:ssn=254:mapset=11
```

This is an example of the possible output.

```
rlghncxa03w 09-07-07 00:34:31 GMT EAGLE5 41.1.0
```

```
MAPSET ID=11     MRNSET=1      MRNPC=007-007-007
PCA              Mate PCA      SSN RC MULT SRM MRC GRP NAME SSO WT
%WT THR
008-008-008          254 10  SHR *Y *Y  grp10   ON  10
6  1
                    200-147-100  254 10  SHR *Y *Y  grp10   ON  20
13  1
                    179-183-050  250 10  SHR *Y *Y  grp15   OFF 30
20  1
                    031-049-100  250 10  SHR *Y *Y  grp15   ON  40
26  1
                    056-113-200  251 10  SHR *Y *Y  grp05   OFF 50
```

33 1

MAP TABLE IS (37 of 36000) 4 % FULL

rtrv-map:pca=255-001-000:ssn=251:mapset=1

This is an example of the possible output.

rlghncxa03w 09-07-07 00:34:31 GMT EAGLE5 41.1.0

MAPSET ID=1	MRNSET=DFLT	MRNPC=005-005-005									
PCA	Mate PCA	SSN RC	MULT	SRM	MRC	GRP	NAME	SSO	WT		
%WT	THR										
255-001-000		251 10	SHR	*Y	*Y	grp01		OFF	50		
55	20										
	253-001-002	254 10	SHR	*Y	*Y	grp01		OFF	10		
11	20										
	255-001-001	56 10	SHR	*Y	*Y	grp05		OFF	30		
33	20										

MAP TABLE IS (37 of 36000) 4 % FULL

rtrv-map:pci=5-005-5:ssn=50:mapset=14

This is an example of the possible output.

rlghncxa03w 09-07-07 00:34:31 GMT EAGLE5 41.1.0

MAPSET ID=14	MRNSET=-----	MRNPC=-----									
PCI	NET	Mate PC	SSN RC	MULT	SRM	MRC	GRP	NAME	SSO	WT	
%WT	THR										
5-005-5			50 10	SHR	*N	*N	grp20		OFF	--	
---	--										
	N	0257	50 10	SHR	*N	*N	grp20		OFF	--	
---	--										
	I	s-5-005-6	50 10	SHR	*N	*N	grp20		OFF	--	
---	--										
	I	5-005-1	50 10	SHR	*N	*N	grp20		OFF	--	
---	--										

MAP TABLE IS (37 of 36000) 4 % FULL

If the Weighted GTT Load Sharing feature is not enabled, the WT, %WT, and THR columns are not shown in the rtrv-map output.

If the GTT Load Sharing with Alternate Routing Indicator feature is not enabled, the MRNSET and MRNPC fields are not shown in the rtrv-map output.

- Backup the new changes using the `chg-db:action=backup:dest=fixed` command.

These messages should appear, the active Maintenance and Administration Subsystem Processor (MASP) appears first.

```
BACKUP (FIXED) : MASP A - Backup starts on active MASP.  
BACKUP (FIXED) : MASP A - Backup on active MASP to fixed disk  
complete.  
BACKUP (FIXED) : MASP A - Backup starts on standby MASP.  
BACKUP (FIXED) : MASP A - Backup on standby MASP to fixed disk  
complete.
```

Figure 2-80 Provision a Load Shared Mated Application - Sheet 1 of 11

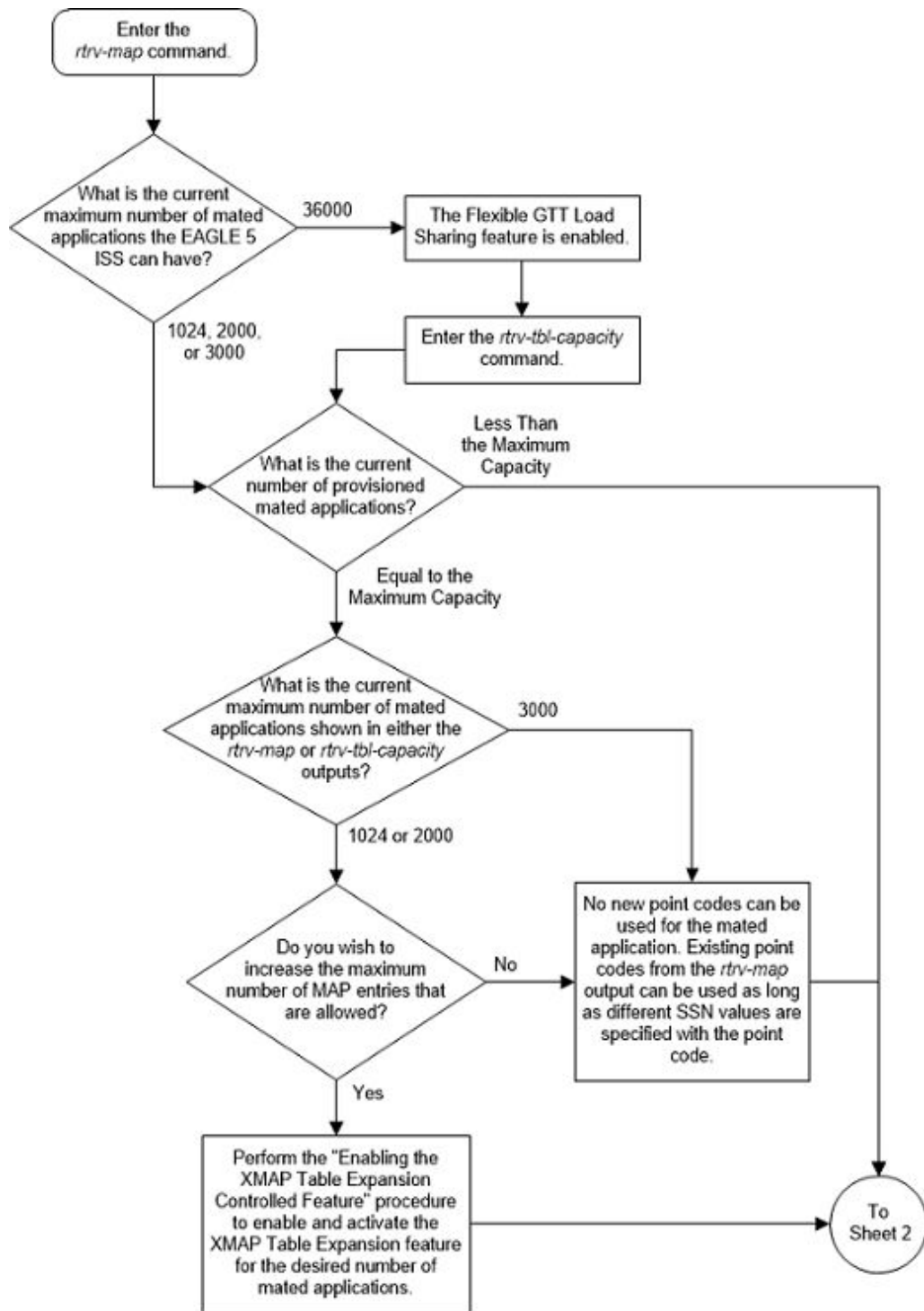

Figure 2-81 Provision a Load Shared Mated Application - Sheet 2 of 11

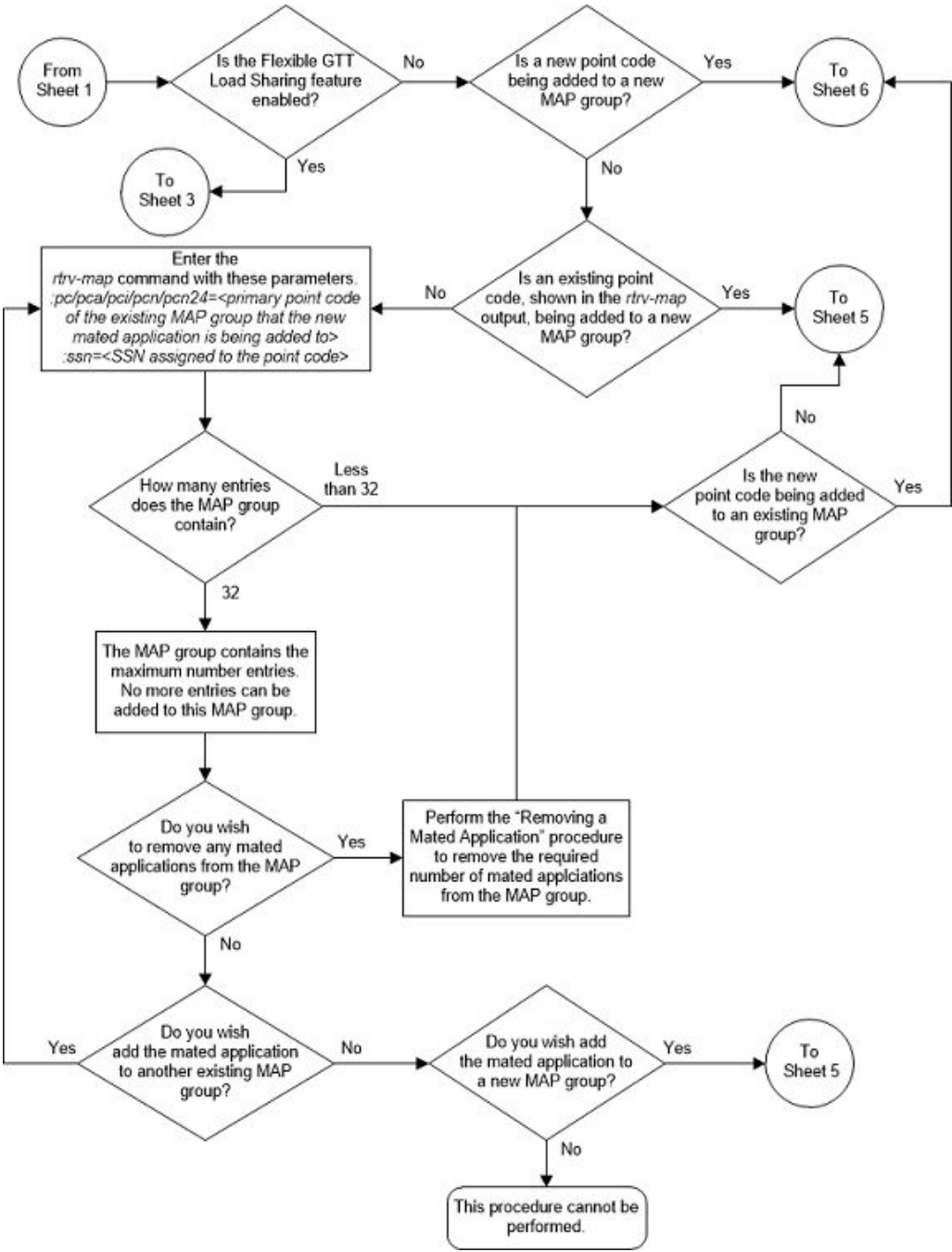

Figure 2-82 Provision a Load Shared Mated Application - Sheet 3 of 11

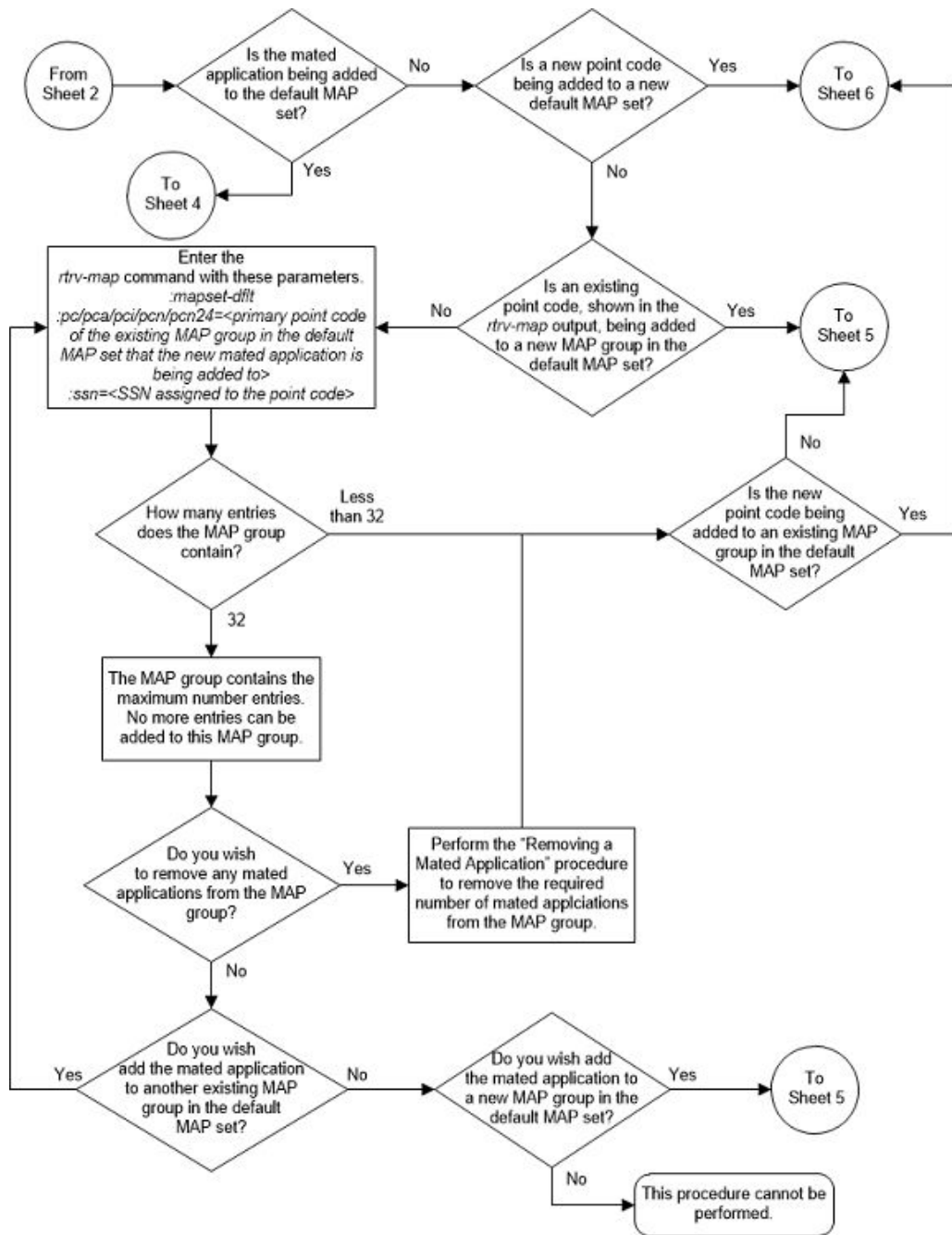

Figure 2-83 Provision a Load Shared Mated Application - Sheet 4 of 11

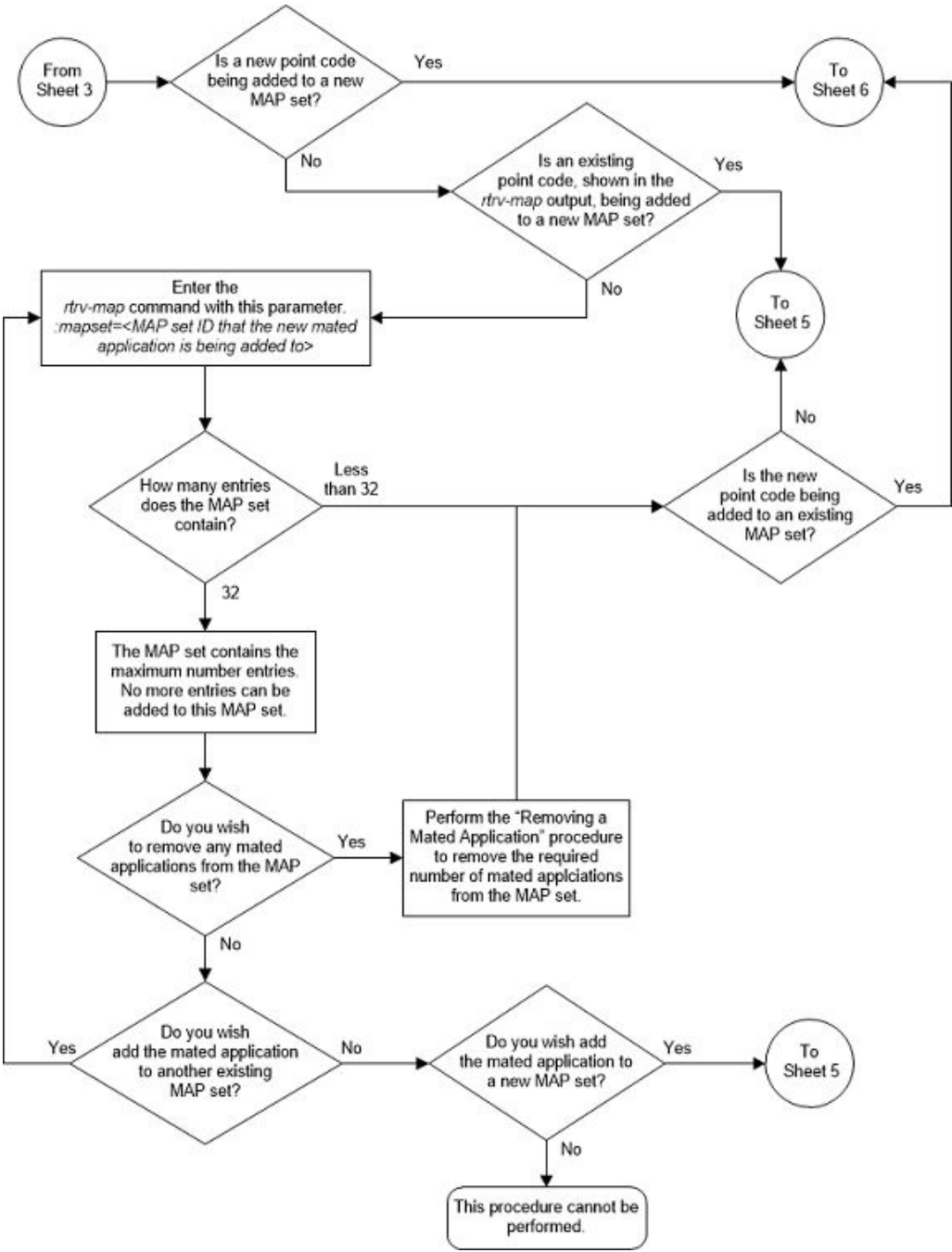

Figure 2-84 Provision a Load Shared Mated Application - Sheet 5 of 11

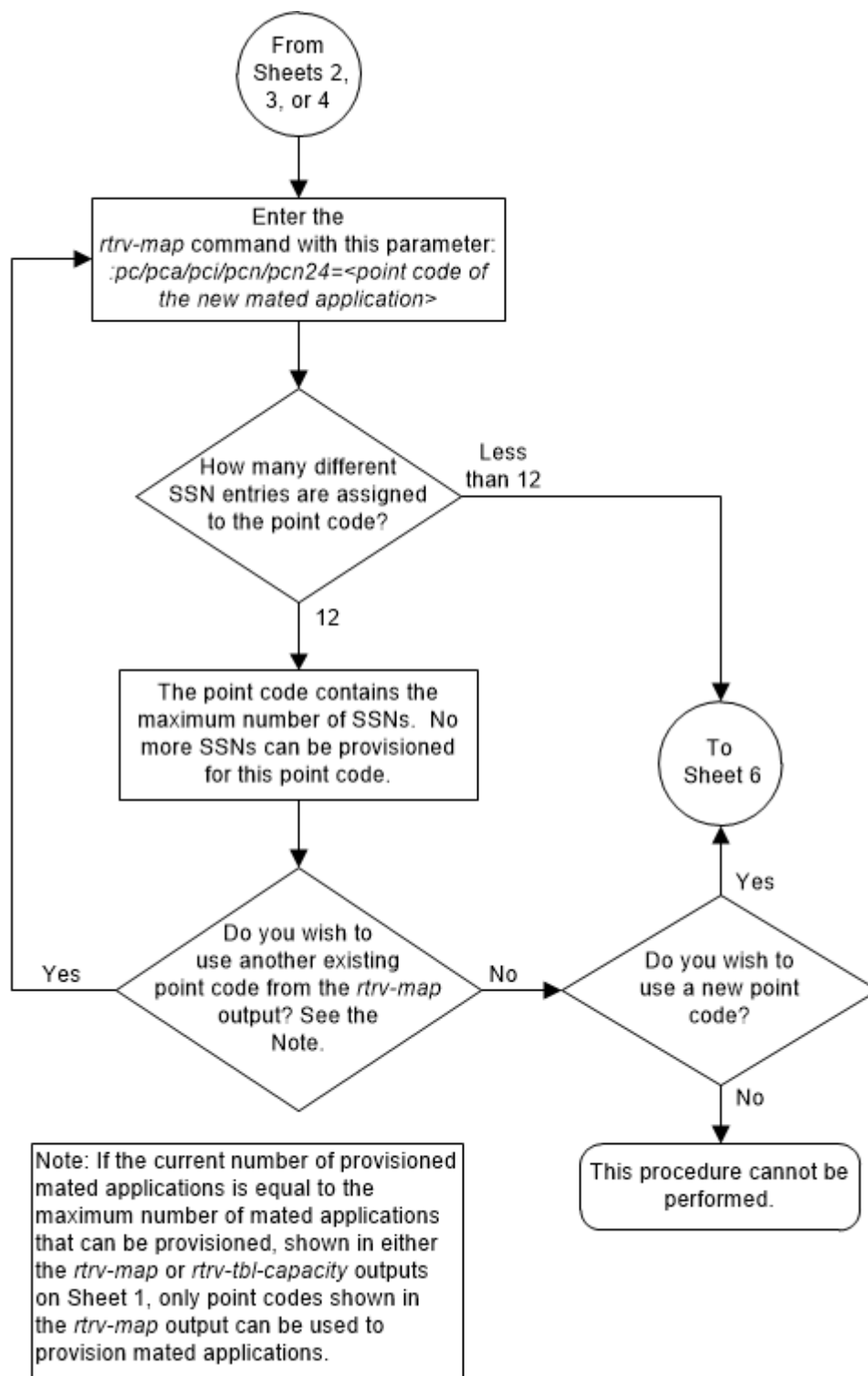

Figure 2-85 Provision a Load Shared Mated Application - Sheet 6 of 11

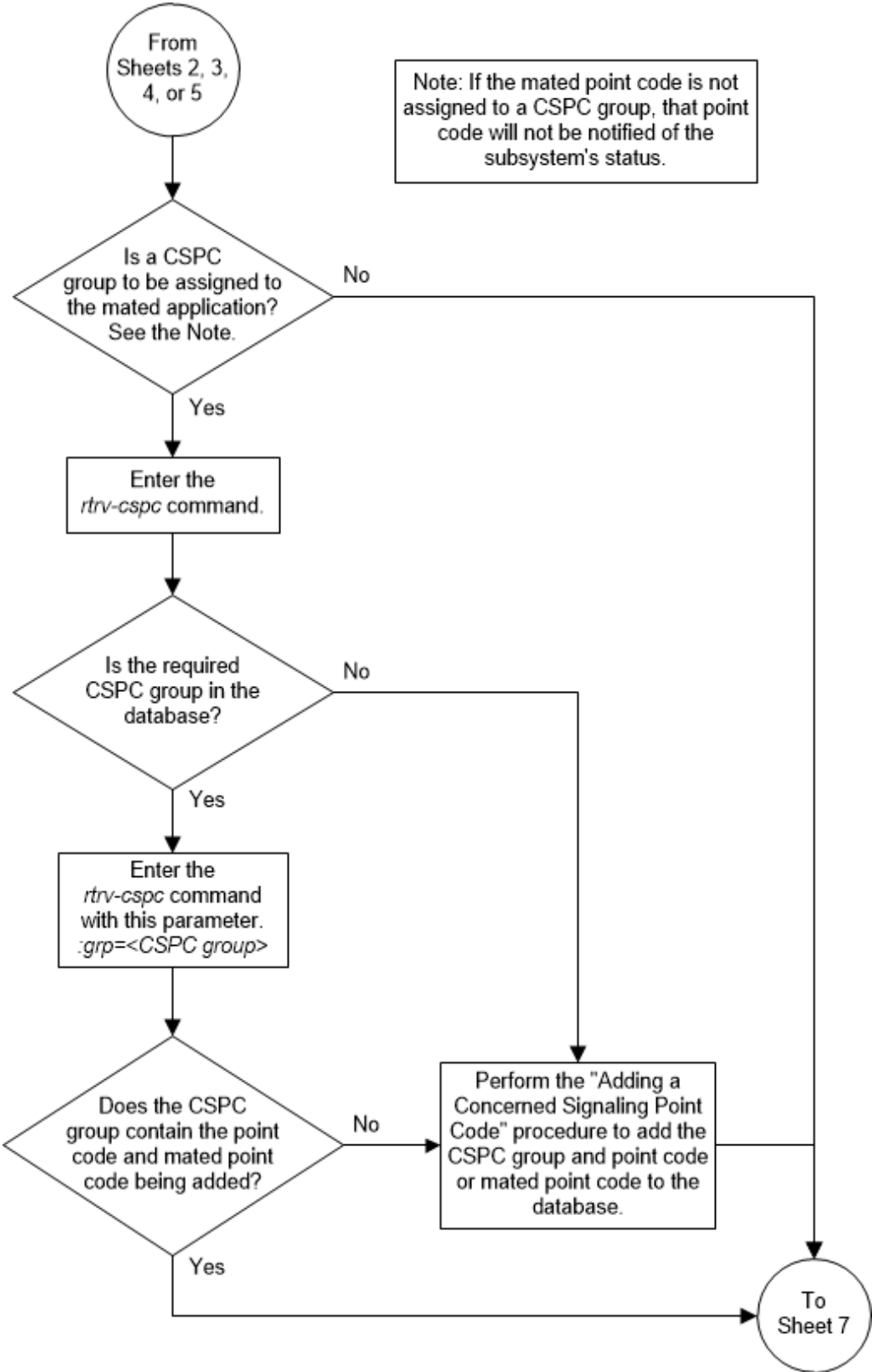

Figure 2-86 Provision a Load Shared Mated Application - Sheet 7 of 11

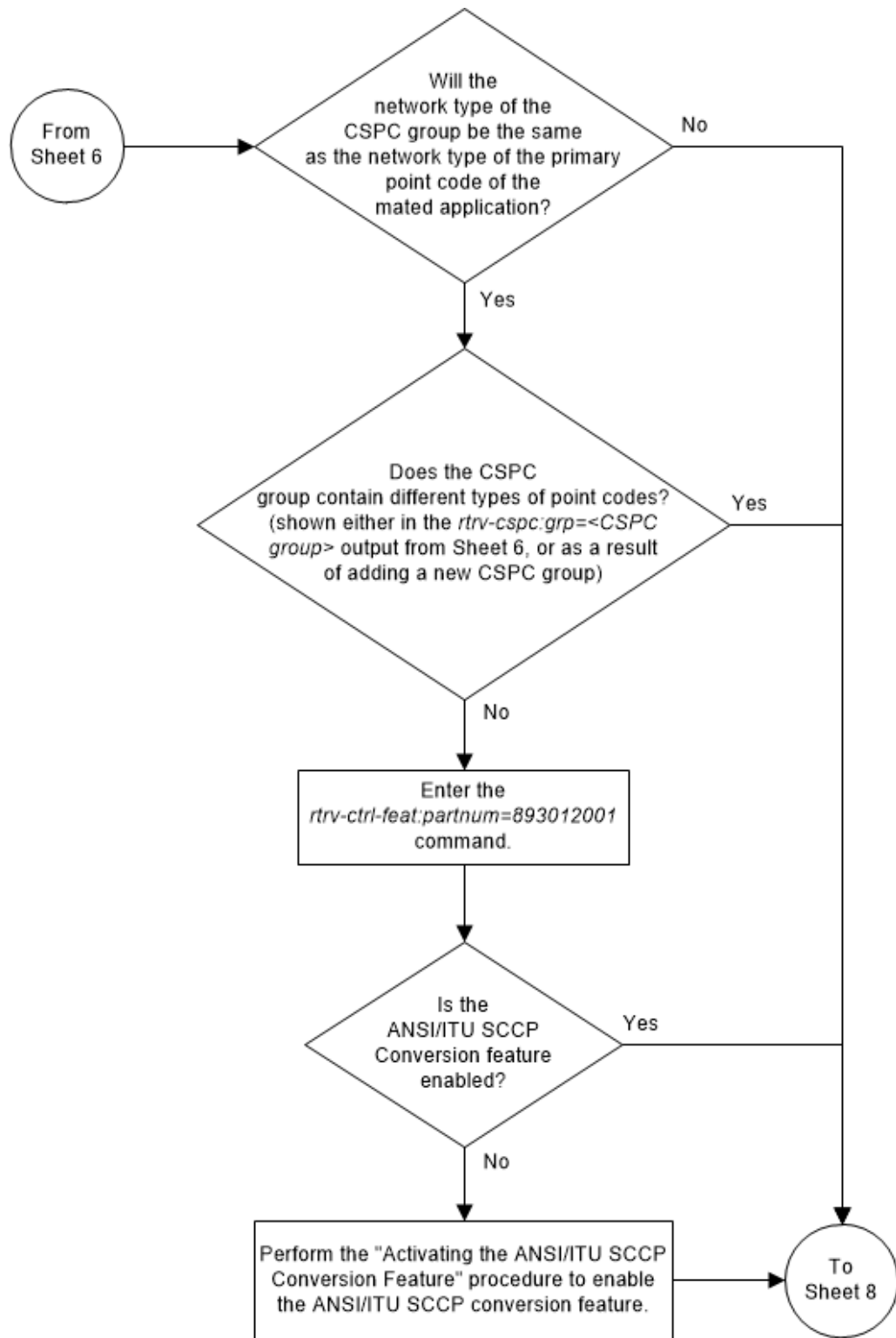

Figure 2-87 Provision a Load Shared Mated Application - Sheet 8 of 11

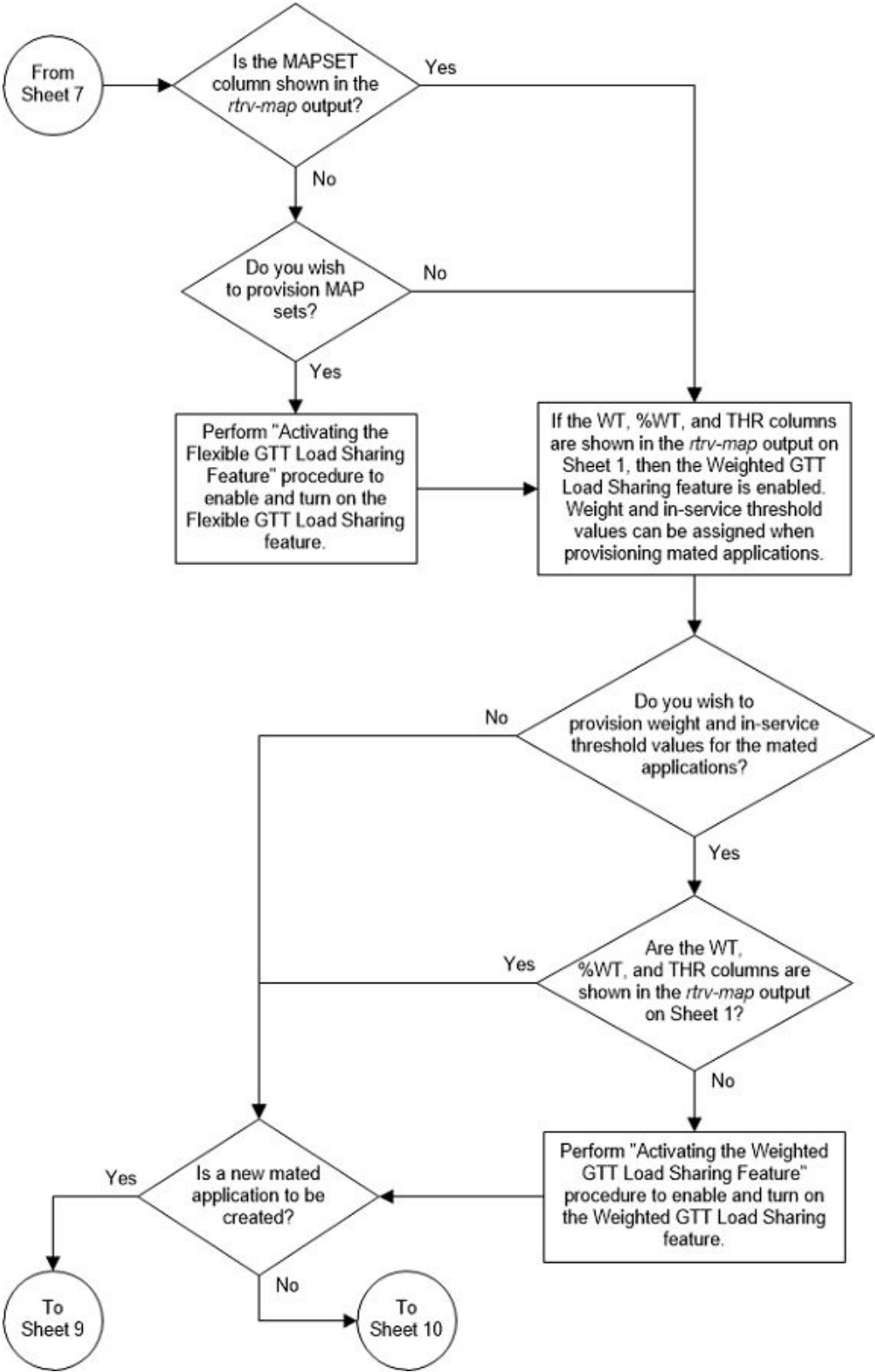

Figure 2-88 Provision a Load Shared Mated Application - Sheet 9 of 11

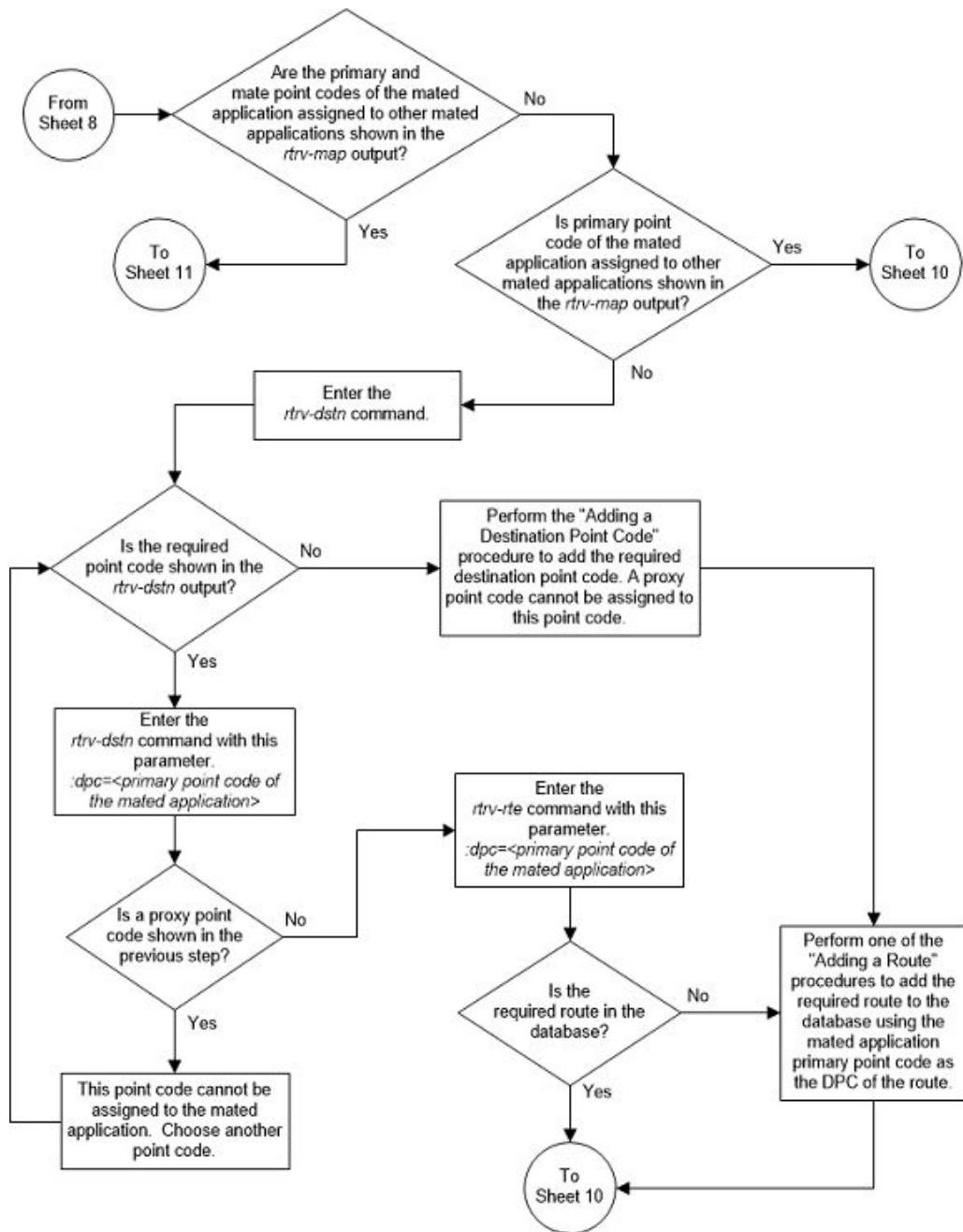

Figure 2-89 Provision a Load Shared Mated Application - Sheet 10 of 11

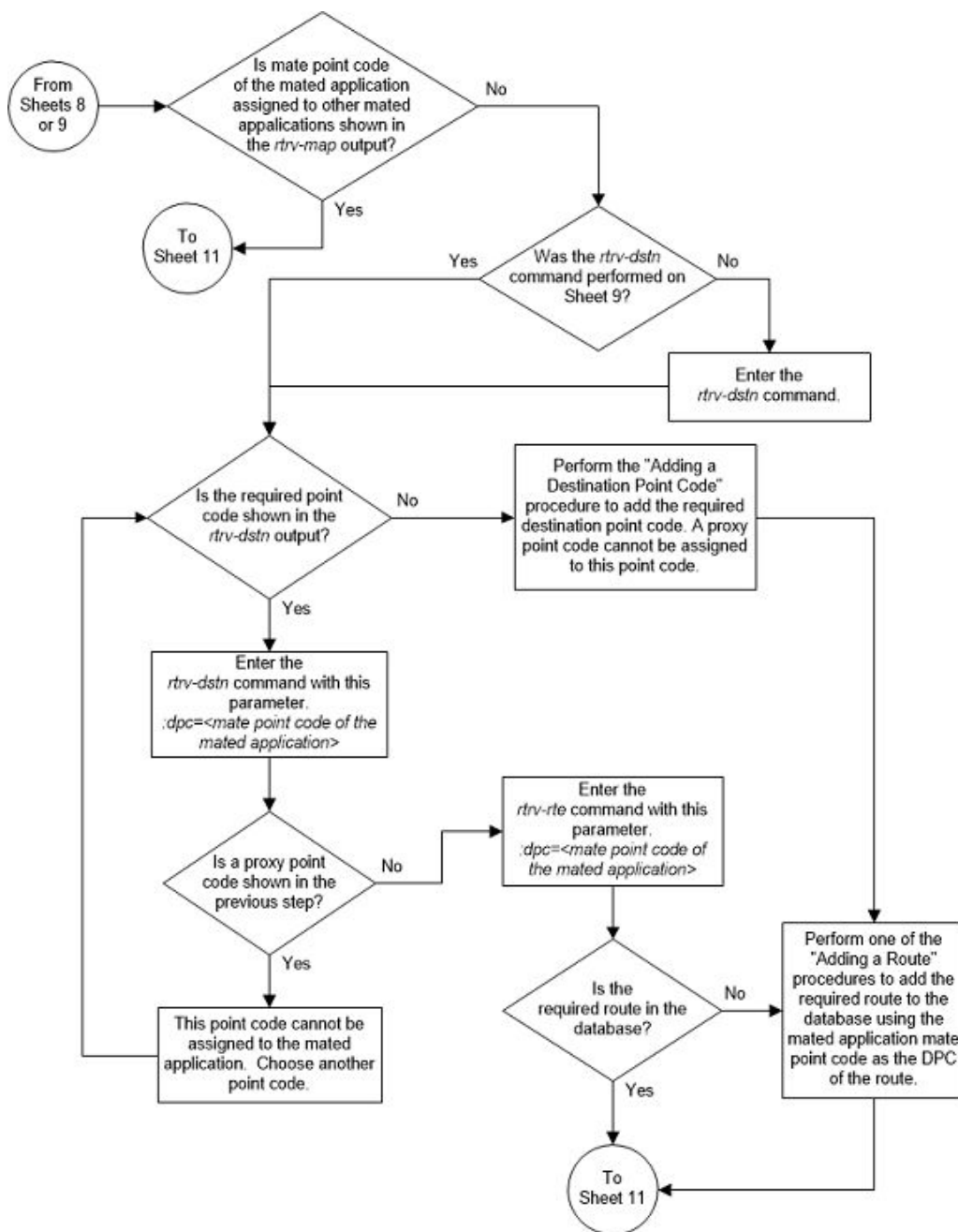
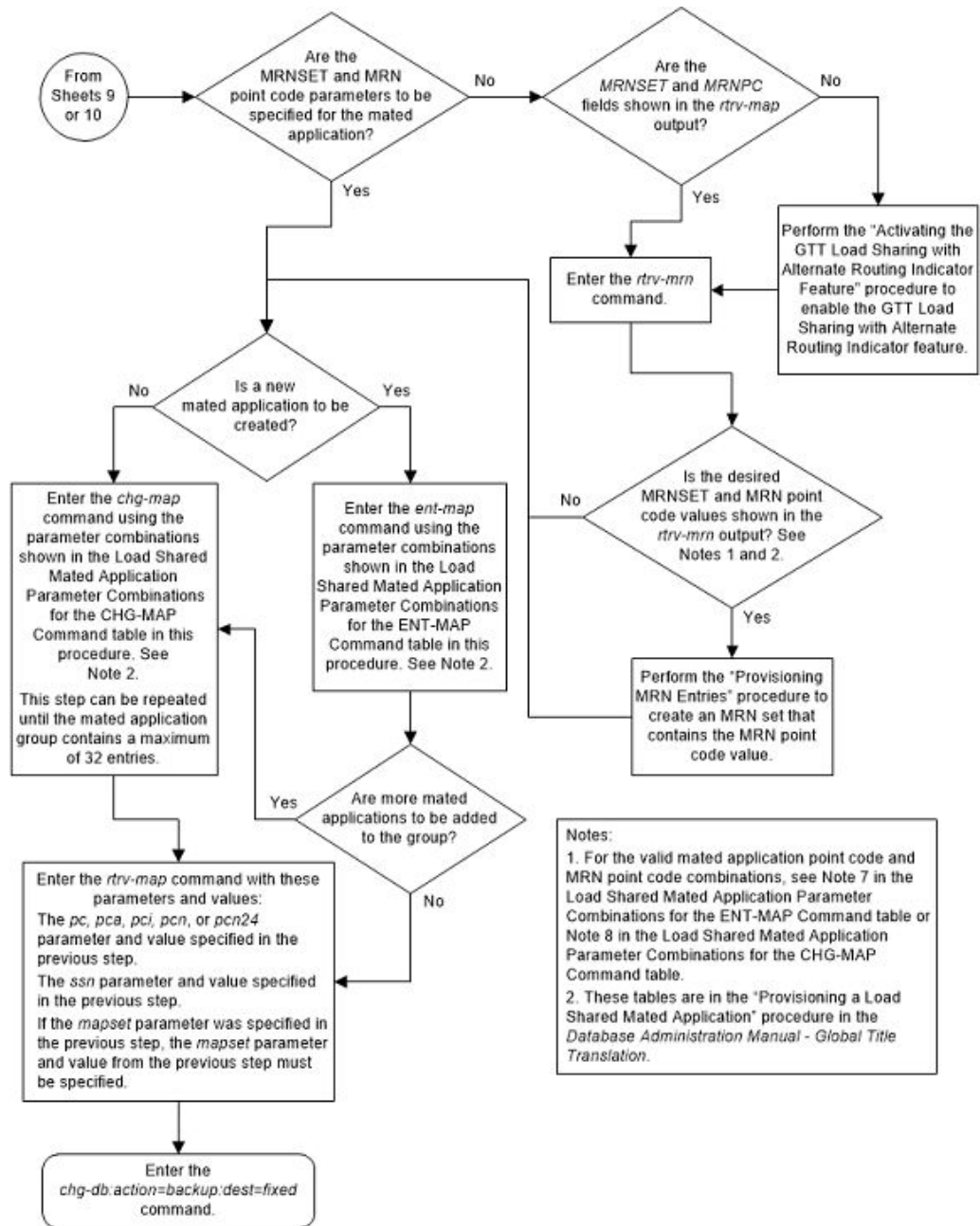

Figure 2-90 Provision a Load Shared Mated Application - Sheet 11 of 11



Provisioning a Combined Dominant/Load Shared Mated Application

This procedure is used to provision a combined dominant/load shared mated application in the database using the `ent-map` and `chg-map` commands. A combined dominant/load shared mated application is a mated application that contains a minimum of two RC (relative cost) values that are equal and a minimum of one RC

value that is different. The `ent-map` and `chg-map` commands use these parameters to provision a combined dominant/load shared mated application.

`:pc/pca/pci/pcn/pcn24` – The point code of the primary signaling point that is to receive the message.

`:mpc/mpca/mpci/mpcn/mpcn24` – The point code of the backup signaling point that is to receive the message.

 **Note:**

The point codes can be either an ANSI point code (`pc/pca`, `mpc/mpca`), ITU-I or ITU-I spare point code (`pci`, `mpci`), a 14-bit ITU-N or 14-bit ITU-N spare point code (`pcn`, `mpcn`), or a 24-bit ITU-N (`pcn24`, `mpcn24`) point code.

 **Note:**

Refer to Chapter 2, *Configuring Destination Tables in Database Administration - SS7 User's Guide* for a definition of the point code types that are used on the EAGLE and for a definition of the different formats that can be used for ITU national point codes.

`:ssn` – Subsystem number – the subsystem address of the primary point code that is to receive the message. The value for this parameter is 2 to 255.

`:mssn` – Mate subsystem number – the subsystem address of the backup point code that is to receive the message. The value for this parameter is 2 to 255.

`:rc` – The relative cost value of the primary point code and subsystem, defined by the `pc/pca/pci/pcn/pcn24` and `ssn` parameters. The `rc` parameter has a range of values from 0 to 99, with the default value being 10.

`:materc` – The relative cost value of the backup point code and subsystem, defined by the `mpc/mpca/mpci/mpcn/mpcn24` and `mssn` parameters. The `materc` parameter has a range of values from 0 to 99, with the default value being 50.

`:grp` – The name of the concerned signaling point code group that contains the point codes that should be notified of the subsystem status. This parameter applies to both RPCs/SSNs. The value for this parameter is shown in the `rtrv-cspc` output. If the desired value is not shown in the `rtrv-cspc` output, perform [Adding a Concerned Signaling Point Code](#) to add the desired group. If this parameter is not specified, then a CSPC group name is not specified for the mated application.

`:mrc` – Message routing under congestion – defines the handling of Class 0 messages during congestion conditions. The value for this parameter is `yes` or `no`. This parameter can be specified for any type of mated application, but this parameter affects only the traffic for a dominant mated application. The default value for ANSI combined dominant/load shared mated applications is `yes`. The default value for ITU combined dominant/load shared mated applications is `no`.

`:srm` – Subsystem routing messages – defines whether subsystem routing messages (SBR, SNR) are transmitted between the mated applications. The value for this parameter is `yes` or `no`. The `srm=yes` parameter can be specified only for ANSI

mated applications. The default value for ANSI combined dominant/load shared mated applications is `yes`. The default value for ITU combined dominant/load shared mated applications is `no`.

`:sso` – Subsystem Status Option – defines whether the subsystem status option is on or off. This parameter allows the user the option to have the specified subsystem marked as prohibited even though an MTP-RESUME message has been received by the indicating that the specified point code is allowed. The value for this parameter is `on` or `off`. The default value is `off`.

`:mapset` – The MAP set ID that the mated applications are assigned to. This parameter can be specified only if the Flexible GTT Load Sharing feature is enabled. This parameter must be specified if the Flexible GTT Load Sharing feature is enabled. If the Flexible GTT Load Sharing feature is enabled, the point code and subsystem specified for the global title translation must be assigned to the MAP set specified by this parameter. The status of the Flexible GTT Load Sharing feature is shown in the `rtrv-ctrl-feat` output. To enable the Flexible GTT Load Sharing feature, perform the [Activating the Flexible GTT Load Sharing Feature](#) procedure.

The `mapset` parameter has three values:

- `dflt` – to assign the MAP to the default MAP set. This value can be specified with both the `ent-map` and `chg-map` commands.
- `new` – to assign the mated application to a new MAP set. This value can be specified only with the `ent-map` command.
- the specific number of an existing MAP set if you are assigning the mated application to an existing MAP set. This value can be specified only with the `chg-map` command.

Refer to the [Provisioning a MAP Set](#) section for information on provisioning MAP sets.

`:wt` – The weight value assigned to the `pc/pca/pci/pcn/pcn24` parameter value. The value of this parameter is from 1 - 99.

`:mwt` – The weight value assigned to the `mpc/mpca/mpci/mpcn/mpcn24` parameter value. The value of this parameter is from 1 - 99.

`:thr` – The in-service threshold assigned to the MAP group or MAP set. The in-service threshold is the minimum percentage (from 1 - 100) of weight that must be available for an RC group (a group of entries in the MAP group or MAP set that have the same RC value assigned) to be considered available to carry traffic. If the percentage of the available weight is less than the in-service threshold, then the entire RC group is considered unavailable for traffic. If the percentage of the available weight is equal to or greater than the in-service threshold, then the RC group is considered available, and traffic can be sent to any available entity in the RC group. The value of the `thr` parameter is assigned to all entries that have the same RC (relative cost) value in the MAP group or MAP set that contain the point code specified in the `ent-map` or `chg-map` command.

Refer to the [Provisioning Weights and In-Service Thresholds for Mated Applications](#) section for information on provisioning MAP groups or MAP sets with weight and in-service threshold values.

`:mrnset` – The MRN set ID that is being assigned to the mated application. This is the MRN set from which alternate routing indicator searches are performed.

:`mrnpc/mrnpca/mrnpai/mrnpai/mrnpai` – The point code assigned to the `mrnset` that is being assigned to the MAP set.

The current values of the `mrnset` and `:mrnpc/mrnpca/mrnpai/mrnpai/mrnpai` parameters are shown in the `rtrv-map` output only if the Flexible GTT Load Sharing and the GTT Load Sharing with Alternate Routing Indicator features are enabled.

The new values for the `mrnset` and `mrnpc/mrnpca/mrnpai/mrnpai/mrnpai` parameters must be shown in the `rtrv-mrn` output.

The network type of the `pc/pca/pai/pai/pai` and `mrnpc/mrnpca/mrnpai/mrnpai/mrnpai` parameter values must be compatible, as shown in [Table 2-48](#).

Table 2-48 MAP and MRN Point Code Parameter Combinations

MAP Point Code Parameter	MRN Point Code Parameter
<code>pc/pca</code>	<code>mrnpc/mrnpca</code>
<code>pai</code> or <code>pai</code> (See Notes 1 and 2)	<code>mrnpai</code> or <code>mrnpai</code> (See Notes 1 and 2)
<code>pai</code>	<code>mrnpai</code>
Notes:	
1. If the network type of the MAP point code parameter is ITU-I (<code>pai</code>), the network type of the MRN point code parameter can be either ITU-I (<code>mappai</code>) or ITU-N (<code>mappai</code>).	
2. If the network type of the MAP point code parameter is ITU-N (<code>pai</code>), the network type of the MRN point code parameter can be either ITU-I (<code>mappai</code>) or ITU-N (<code>mappai</code>).	

A combined dominant/load shared mated application can contain up to 128 point codes and subsystems, a primary point code and subsystem, and up to 31 mated point codes and subsystems. When a new combined dominant/load shared mated application is added to the database, the first two entries, the primary point code and subsystem and a mate point code and subsystem are added using the `ent-map` command. All other mated point code and subsystem entries that are being assigned to the primary point code and subsystem are added to the combined dominant/load shared mated application using the `chg-map` command.

A combined dominant/load shared mated application is a combination of the dominant and load sharing mated applications. This mated application must contain a minimum of two RC values that are equal and a minimum of one RC value that is different. The traffic is shared between the point codes with the lowest relative cost values. If these point codes and subsystems become unavailable, the traffic is routed to the other point codes and subsystems in the mated application and shared between these point codes and subsystems.

If the Flexible GTT Load Sharing feature is not enabled, the primary point code and subsystem number or the mate point code and mate subsystem number combination can be in the database only once. If the Flexible GTT Load Sharing feature is enabled, the primary point code and subsystem number or mate point code and mate subsystem number combination can be in multiple MAP sets, but can be in the default MAP set only once. Refer to the [Provisioning a MAP Set](#) section for information on provisioning MAP sets.

The point codes specified in the `ent-map` or `chg-map` commands (`pc/pca`, `pai`, `pai`, or `pai`, and `mrnpc/mrnpca`, `mrnpai`, `mrnpai`, or `mrnpai`) must be either a full point code in the routing point code table or the EAGLE's true point code. Cluster point codes or network routing point codes cannot be specified with this command. The `rtrv-rte`

command can be used to verify the point codes in the routing table. The point codes in the routing table are shown in the `DPCA`, `DPCI`, `DPCN`, or `DPCN24` fields of the `rtrv-rte` command output. The EAGLE's true point code is shown in the `PCA`, `PCI`, `PCN`, or `PCN24` fields of the `rtrv-sid` command output.

A combined dominant/load shared mated application can be provisioned with a point code that is assigned to other mated applications as long as the SSN is not assigned to other mated applications. A point code can be assigned to maximum of 12 different SSNs.

For mated applications containing ANSI or 24-bit ITU-N point codes, or the EAGLE's true point code, the format of the point codes specified in the `ent-map` command must be the same. For example, if the primary point code is a 24-bit ITU-N point code (`pcn24`), the mate point code must be a 24-bit ITU-N point code (`mpcn24`). The mate point codes of mated applications containing either ITU-I, ITU-I spare, 14-bit ITU-N, or 14-bit ITU-N spare primary point codes do not have to be the same format as the primary point code. The mate point codes of these mated applications can be a mixture of ITU-I, ITU-I spare, 14-bit ITU-N, or 14-bit ITU-N spare point codes.

The format of the point codes in the CSPC group specified with the `grp` parameter must be the same as the primary point code specified with the `ent-map` command only if the ANSI/ITU SCCP Conversion feature is not enabled. If the ANSI/ITU SCCP Conversion feature is enabled, the CSPC group may contain a mixture of point code types (refer to the [Adding a Concerned Signaling Point Code](#) procedure), and the network type of the CSPC group can be different from the network type of the primary point code of the mated application. The status of the ANSI/ITU SCCP Conversion feature can be verified with the `rtrv-ctrl-feat` command.

The values for the primary point code and subsystem combination (`pc/ssn`) cannot be the same as the mated point code and subsystem combination (`mpc/mssn`). However, the primary and mated point codes can be the same as long as the subsystem numbers are different.

If a mate point code (`mpc/mpca/mpci/mpcn/mpcn24`) is specified, the `mssn` parameter must be specified. Also, the point code type of the mate point code must be the same as the point code type of the primary point code. For example, if the primary point code is a 24-bit ITU-N point code (`pcn24`), the mate point code must be a 24-bit ITU-N point code (`mpcn24`). If spare point codes are being used, both the primary and mate point codes must be spare point codes. For example, if the primary point code is an ITU-I spare point code, the mate point code must be an ITU-I spare point code.

If the `mssn` parameter is specified, the mate point code (`mpc/mpca/mpci/mpcn/mpcn24`) must be specified.

If the `grp`, `srn`, `mrc`, and `sso` parameter values are specified, and the specified point code and SSN is assigned to multiple mated applications, the `grp`, `srn`, `mrc`, and `sso` values for all mated applications containing the specified point code and SSN will be changed to the values specified in this procedure.

The EAGLE can contain 1024, 2000, or 3000 mated applications. The EAGLE default is 1024 mated applications. This quantity can be increased to 2000 by enabling the feature access key for part number 893-0077-01, or to 3000 by enabling the feature access key for part number 893-0077-10. For more information on enabling these feature access keys, refer to the [Enabling the XMAP Table Expansion Feature](#) procedure.

Provisioning a MAP Set

The Flexible GTT Load Sharing feature provides the ability to define multiple load sharing sets in the MAP table where the same point code and subsystem can be assigned to different load sharing sets.

The MAP table contains specific load sharing sets, designated by numbers, and a default MAP set.

Flexible Final GTT Load Sharing provides flexible load sharing for global title translations defined in the GTT table and not for the MPS-based features. The MPS-based features do not support the MAP set ID parameter. The MPS-based features perform lookups for load sharing in the default MAP set and the GTT table. The entries in the GTT table can be linked to a MAP set ID, allowing lookups in a specific MAP set other than the default MAP set.

Any MAP entries that were provisioned in the database before the Flexible GTT Load Sharing feature is enabled are placed in the default MAP set when the Flexible GTT Load Sharing feature is enabled.

To provision entries in the default MAP set, the `mapset=dflt` parameter must be specified with the `ent-map` or `chg-map` commands.

To provision entries in an existing MAP set other than the default MAP set, the `mapset=<MAP set ID>` parameter must be specified with the `chg-map` command. Provisioning entries in an existing MAP set can be performed only with the `chg-map` command.

To provision entries in a new MAP set, the `mapset=new` parameter must be specified with the `ent-map` command. The `mapset=new` parameter can be specified only with the `ent-map` command. When the `ent-map` command is executed with the `mapset=new` parameter, the new MAP set ID is automatically generated and displayed in the output of the `ent-map` command as follows.

```
New MAPSET Created : MAPSETID = <new MAP set ID>
```

A MAP set, other than the default MAP set, is a MAP group provisioned with the MAP set ID and can contain a maximum of 128 point codes.

The default MAP set can contain multiple MAP groups. The point code and subsystem number combination can appear only once in the default MAP set. The point code can appear in multiple MAP groups in the default MAP set with different subsystem numbers.

The point code and subsystem number combination provisioned in a MAP set can be provisioned in multiple MAP sets. All the point codes in a MAP set must be different.

Provisioning Weights and In-Service Thresholds for Mated Applications

Weighted GTT Load Sharing allows unequal traffic loads to be provisioned in MAP load sharing groups or MAP load sharing sets. This feature also allows provisioning control over load sharing groups or sets so that if insufficient capacity within the load sharing group or set is available, the load sharing group or set is not used.

To provision the weight values and in-service threshold values for MAP groups or MAP sets in this procedure, the `wt`, `mwt`, and `thr` parameters are used.

The `wt`, `mwt`, and `thr` parameters can be used only:

- If the MAP group or MAP set is either a load shared or combined dominant/load shared MAP group or MAP set.
- If the Weighted GTT Load Sharing feature is enabled and turned on.

The status of the Weighted GTT Load Sharing feature can be verified by entering the `rtrv-ctrl-feat` command. If the Weighted GTT Load Sharing feature is not enabled or not turned on, perform the [Activating the Weighted GTT Load Sharing Feature](#) procedure to enable and turn on the Weighted GTT Load Sharing feature.

If either the `wt` or `mwt` parameters are specified with the `ent-map` command, both parameters must be specified with the `ent-map` command.

To assign an in-service threshold value to the entries of a MAP group or MAP set that contains the point code value specified in the `ent-map` command, use the `thr` parameter with the `wt` and `mwt` parameters. When the `thr` parameter is specified with the `ent-map` command, the in-service threshold value is assigned to both entries specified in the `ent-map` command. The `thr` parameter cannot be specified with the `chg-map` command when adding additional entries to the MAP group or MAP set. When additional entries are added to the MAP group or MAP set with the `chg-map` command, the `thr` value that was specified in the `ent-map` command is assigned to the additional entries. For information on using the `thr` parameter with the `chg-map` command, refer to the [Changing the Weight and In-Service Threshold Values of a Mated Application](#) procedure.

The `thr` parameter does not have to be specified with the `ent-map` command. If the `thr` parameter is not specified with the `ent-map` command, the `THR` parameter value for the MAP group or MAP set is set to 1.

Specifying the `wt` and `mwt` parameters assigns a weight value to the point codes specified in the `ent-map` command. The `wt` parameter value is assigned to the `mpc/mpca/mpci/mpcn/mpcn24` parameter value and the `mwt` parameter value is assigned to the `mpc/mpca/mpci/mpcn/mpcn24` parameter value.

When additional entries are added to the MAP group or MAP set with the `chg-map` command, and the MAP group or MAP set entries have weight and in-service threshold values assigned, a weight value must be assigned to the `mpc/mpca/mpci/mpcn/mpcn24` parameter value using the `mwt` parameter.

The `wt` parameter does not have to be specified with the `chg-map` command. If the `wt` parameter is specified with the `chg-map` command, the weight value for the `pc/pca/pci/pcn/pcn24` parameter is not changed.

If the `wt` parameter is specified with the `chg-map` command and the `wt` value is the same as the value currently assigned to the `pc/pca/pci/pcn/pcn24` parameter, the weight value for the `pc/pca/pci/pcn/pcn24` parameter is not changed.

If the `wt` parameter is specified with the `chg-map` command and the `wt` value is different from the value currently assigned to the `pc/pca/pci/pcn/pcn24` parameter, the weight value for the `pc/pca/pci/pcn/pcn24` parameter is changed to the new `wt` value.

The weight values assigned to the entries in the MAP group or MAP set are shown in the `WT` column in the `rtrv-map` output.

The in-service threshold values assigned to the entries in the MAP group or MAP set are shown in the `THR` column in the `rtrv-map` output.

The %WT column in the `rtrv-map` output shows the percentage of the traffic the particular entry in the MAP group or MAP set will handle.

The WT, %WT, and THR columns are shown in the `rtrv-map` output only if the Weighted GTT Load Sharing feature is enabled and turned on.

For more information on the Weighted GTT Load Sharing feature, refer to the [Weighted GTT Load Sharing](#) section.

Canceling the RTRV-MAP Command

Because the `rtrv-map` command used in this procedure can output information for a long period of time, the `rtrv-map` command can be canceled and the output to the terminal stopped. There are three ways that the `rtrv-map` command can be canceled.

- Press the F9 function key on the keyboard at the terminal where the `rtrv-map` command was entered.
- Enter the `canc-cmd` without the `trm` parameter at the terminal where the `rtrv-map` command was entered.
- Enter the `canc-cmd:trm=<xx>`, where `<xx>` is the terminal where the `rtrv-map` command was entered, from another terminal other than the terminal where the `rtrv-map` command was entered. To enter the `canc-cmd:trm=<xx>` command, the terminal must allow Security Administration commands to be entered from it and the user must be allowed to enter Security Administration commands. The terminal's permissions can be verified with the `rtrv-secu-trm` command. The user's permissions can be verified with the `rtrv-user` or `rtrv-secu-user` commands.

For more information about the `canc-cmd` command, refer to *Commands User's Guide*.

1. Display the mated applications in the database using the `rtrv-map` command.

This is an example of the possible output.

```
rlghncxa03w 09-07-07 00:34:31 GMT EAGLE5 41.1.0

MAPSET ID=DFLT
PCA           Mate PCA           SSN RC MULT SRM MRC GRP NAME SSO
255-001-000   250 10 SOL *Y *Y grp01 ON

MAPSET ID=1
PCA           Mate PCA           SSN RC MULT SRM MRC GRP NAME SSO
255-001-000   251 10 SHR *Y *Y grp01 OFF
                253-001-002 254 10 SHR *Y *Y grp01 OFF

MAPSET ID=2
PCA           Mate PCA           SSN RC MULT SRM MRC GRP NAME SSO
255-001-000   252 10 SOL *Y *Y grp01 ON

MAPSET ID=DFLT
PCA           Mate PCA           SSN RC MULT SRM MRC GRP NAME SSO
255-001-000   253 10 SHR *Y *Y grp01 OFF
                253-001-004 254 10 SHR *Y *Y grp01 OFF
```

```

MAPSET ID=3
PCA      Mate PCA      SSN RC MULT SRM MRC GRP NAME SSO
255-001-001      255 10  DOM YES YES grp01  ON
                253-001-005  254 20  DOM YES YES grp01  ON

MAPSET ID=4
PCA      Mate PCA      SSN RC MULT SRM MRC GRP NAME SSO
255-001-001      250 10  DOM YES YES grp01  OFF
                253-001-001  254 20  DOM YES YES grp01  OFF

MAPSET ID=DFLT
PCA      Mate PCA      SSN RC MULT SRM MRC GRP NAME SSO
255-001-002      251 10  SHR *Y *Y grp01  OFF
                255-001-002  254 10  SHR *Y *Y grp01  OFF

MAPSET ID=5
PCA      Mate PCA      SSN RC MULT SRM MRC GRP NAME SSO
255-001-002      252 10  DOM YES YES grp01  ON
                255-001-003  254 20  DOM YES YES grp01  ON

MAPSET ID=6
PCA      Mate PCA      SSN RC MULT SRM MRC GRP NAME SSO
255-001-002      253 10  SHR *Y *Y grp01  ON
                255-001-004  254 10  SHR *Y *Y grp01  ON

MAPSET ID=7
PCA      Mate PCA      SSN RC MULT SRM MRC GRP NAME SSO
002-002-007      50 10  COM YES *Y grp01  OFF
                002-002-008  30 10  COM YES *Y grp01  OFF
                002-002-009  30 10  COM YES *Y grp01  OFF
                002-002-010  30 20  COM YES *Y grp01  OFF
                002-002-011  30 20  COM YES *Y grp01  OFF

MAPSET ID=8
PCI      Mate PCI      SSN RC MULT SRM MRC GRP NAME SSO
2-001-2      255 10  DOM NO  YES grp03  OFF
                2-001-1      254 20  DOM NO  YES grp03  OFF

MAPSET ID=9
PCN      Mate PCN      SSN RC MULT SRM MRC GRP NAME SSO
00347      253 10  SHR *N *N grp05  OFF
                01387      254 10  SHR *N *N grp05  OFF

MAP TABLE IS (25 of 36000) 1 % FULL

```

If any of the following items are not shown in the `rtrv-map` output, then the feature corresponding to these items is not enabled, or turned on if required.

- The `MAPSET` field - the Flexible GTT Load Sharing feature is not enabled.
- The `MRNSET` and `MRNPC` fields - the GTT Load Sharing with Alternate Routing Indicator feature is not enabled.
- The `WT`, `%WT`, `THR` columns - the Weighted GTT Load Sharing feature is not enabled and turned on.

If the maximum number of mated applications shown in the `rtrv-map` output in [1](#) is 1024, 2000, or 3000, continue the procedure with [3](#).

2. If the maximum number of mated applications shown in the `rtrv-map` output in [1](#) is 36000, the Flexible GTT Load Sharing feature is enabled.

Although the `rtrv-map` output shows there can be 36000 entries, a maximum of 1024, 2000, or 3000 different point codes (depending on whether the XMAP Table Expansion feature is enabled for 2000 or 3000 mated applications) can be provisioned for mated applications. To verify the number of different point codes that can be provisioned for mated applications, enter the `rtrv-tbl-capacity` command. The following is an example of the possible output.

```
rlghncxa03w 07-05-28 21:15:37 GMT EAGLE5 37.0.0
```

```
MAP table is (3000 of 3000) 100% full
```

 **Note:**

The `rtrv-tbl-capacity` command output contains other fields that are not used by this procedure. If you wish to see all the fields displayed by the `rtrv-tbl-capacity` command, see the `rtrv-tbl-capacity` command description in *Commands User's Guide*.

3. Continue the procedure by performing one of these steps.
 - If the `rtrv-map` output in [1](#) or the `rtrv-tbl-capacity` output in [2](#) shows that the maximum number of mated applications is 3000, and the current number of provisioned mated applications is 3000, no new point codes can be used to provision mated applications. Continue the procedure with [4](#).
 - If the If the `rtrv-map` output in [1](#) or the `rtrv-tbl-capacity` output in [2](#) shows that the maximum number of mated applications is either 1024 or 2000, and the mated application being added increases the number beyond 1024 or 2000, perform the [Enabling the XMAP Table Expansion Feature](#) procedure to enable a greater quantity of mated applications. After the quantity of mated applications has been increased, continue the procedure with [4](#). If the maximum number of mated applications is not increased, no new point codes can be used to provision mated applications.
 - If the `rtrv-map` output in [1](#) or the `rtrv-tbl-capacity` output in [2](#) shows that the maximum number of mated applications is either 1024, 2000, or 3000 and the mated application being added will not increase the number beyond the quantity shown in the `rtrv-map` output in [1](#) or the `rtrv-tbl-capacity` output in [2](#), continue the procedure with [4](#).
4. A MAP group, without the Flexible GTT Load Sharing feature enabled, a MAP set, other than the default MAP set, and a MAP group contained in the default MAP set can contain a maximum of 128 entries.

Verify the number of entries that the MAP group or MAP set contains by entering the `rtrv-map` command with the primary point code and SSN assigned to the MAP group or MAP set. If the Flexible GTT Load Sharing feature is enabled, the `mapset` parameter and MAP set ID of the MAP set that the new mated application will be added to.

If the specified MAP set is not the default MAP set, only the `mapset` parameter needs to be specified with the `rtrv-map` command. The point code and SSN does not need to be specified.

For this example, enter one of these commands.

```
rtrv-map:pca=002-002-007:ssn=50
```

The following is an example of the possible output.

```
rlghncxa03w 09-07-07 00:34:31 GMT EAGLE5 41.1.0
```

PCA	Mate PCA	SSN	RC	MULT	SRM	MRC	GRP	NAME	SSO
002-002-007		50	10	COM	YES	*Y	grp01		OFF
	002-002-008	30	10	COM	YES	*Y	grp01		OFF
	002-002-009	30	10	COM	YES	*Y	grp01		OFF
	002-002-010	30	20	COM	YES	*Y	grp01		OFF
	002-002-011	30	20	COM	YES	*Y	grp01		OFF

```
MAP TABLE IS (25 of 1024) 2 % FULL
```

```
rtrv-map:pca=002-002-007:ssn=50:mapset=dflt
```

The following is an example of the possible output.

```
rlghncxa03w 09-07-07 00:34:31 GMT EAGLE5 41.1.0
```

PCA	Mate PCA	SSN	RC	MULT	SRM	MRC	GRP	NAME	SSO
MAPSET ID=DFLT									
002-002-007		50	10	COM	YES	*Y	grp01		OFF
	002-002-008	30	10	COM	YES	*Y	grp01		OFF
	002-002-009	30	10	COM	YES	*Y	grp01		OFF
	002-002-010	30	20	COM	YES	*Y	grp01		OFF
	002-002-011	30	20	COM	YES	*Y	grp01		OFF

```
MAP TABLE IS (25 of 1024) 2 % FULL
```

```
rtrv-map:mapset=7
```

The following is an example of the possible output.

```
rlghncxa03w 09-07-07 00:34:31 GMT EAGLE5 41.1.0
```

PCA	Mate PCA	SSN	RC	MULT	SRM	MRC	GRP	NAME	SSO
MAPSET ID=7									
002-002-007		50	10	COM	YES	*Y	grp01		OFF
	002-002-008	30	10	COM	YES	*Y	grp01		OFF
	002-002-009	30	10	COM	YES	*Y	grp01		OFF
	002-002-010	30	20	COM	YES	*Y	grp01		OFF
	002-002-011	30	20	COM	YES	*Y	grp01		OFF

```
MAP TABLE IS (25 of 1024) 2 % FULL
```

If the MAP group or MAP set contains 128 entries, no more entries can be added to the specified MAP group or MAP set. One of these actions can be performed.

- Entries can be added another MAP group or MAP set. Repeat this step for the other MAP group or MAP set.
- Entries can be removed from the specified MAP group or MAP set. To remove entries from the specified MAP group or MAP set, perform the [Removing a Mated Application](#) procedure.
- Entries can be added to a new MAP group or MAP set.

 **Note:**

If none of these actions will be performed, then this procedure cannot be performed.

If the MAP group or MAP set contains less than 128 entries, entries can be added to the MAP group or MAP set.

After it has been determined which MAP group or MAP set that the new entries will be added to (a new MAP group or MAP set or an existing MAP group or MAP set), continue the procedure by performing one of these steps.

- If an existing point code is being added to this MAP group or MAP set, continue the procedure with [5](#).
 - If a new point code is being added to this MAP group or MAP set, continue the procedure by performing one of these steps.
 - If a concerned signaling point code (CSPC) group is not being assigned to the mated application, continue the procedure with [8](#). If the mated point code is not assigned to a CSPC group, that point code will not be notified of the subsystem's status.
 - If a concerned signaling point code (CSPC) group will be assigned to the mated application, continue the procedure with [6](#).
- 5.** A mated application can be provisioned with a point code that is assigned to other mated applications as long as the SSN is not assigned to other mated applications.

A point code can be assigned to maximum of 12 different SSNs.

Verify the number of SSNs assigned to the point code that will be specified for the mated application in this procedure by entering the `rtrv-map` command with the point code of the new mated application. For this example, enter this command.

```
rtrv-map:pca=255-001-000
```

This is an example of the possible output.

```
rlghncxa03w 09-07-07 00:34:31 GMT EAGLE5 41.1.0
```

PCA	Mate PCA	SSN	RC	MULT	SRM	MRC	GRP	NAME	SSO
255-001-000		250	10	SOL	*Y	*Y	grp01		ON
255-001-000		251	10	SHR	*Y	*Y	grp01		OFF
	253-001-002	254	10	SHR	*Y	*Y	grp01		OFF
255-001-000		252	10	SOL	*Y	*Y	grp01		ON

```

255-001-000                253 10 SHR *Y *Y grp01 OFF
                253-001-004 254 10 SHR *Y *Y grp01 OFF

```

```
MAP TABLE IS (25 of 1024) 2 % FULL
```

If the Flexible GTT Load Sharing feature is enabled, the MAPSET IDs for the mated applications are shown in the `rtrv-map` output.

If the Weighted GTT Load Sharing feature is enabled and turned, the `WT`, `%WT`, and `THR` columns are shown in the `rtrv-map` output.

If the point code is assigned to 12 different SSNs, and neither an existing point code in the `rtrv-map` output nor a new point code will be used to provision the mated application, then this procedure cannot be performed.

If the point code is assigned to less than 12 different SSNs, then the existing point code in the `rtrv-map` output can be used to provision the mated application.

If the point code is assigned to 12 different SSNs, another existing point code in the `rtrv-map` output or a new point code must be used to provision the mated application. If an existing point code in the `rtrv-map` output will be used to provision the mated application, repeat this step for that point code.

After it has been determined which point code will be used to provision the mated application (a new point code or an existing point code), continue the procedure by performing one of these steps.

- If a concerned signaling point code (CSPC) group is not being assigned to the mated application, continue the procedure with 8. If the mated point code is not assigned to a CSPC group, that point code will not be notified of the subsystem's status.
 - If a concerned signaling point code (CSPC) group will be assigned to the mated application, continue the procedure with 6.
6. Display the point codes in the CSPC group that you wish to assign to the mated application by first entering the `rtrv-cspc` command with no parameters.

This is an example of the possible output.

```

rlghncxa03w 06-10-25 09:48:31 GMT EAGLE5 36.0.0
CSPC GRP NETWORK PERCENT FULL
grp01 ANSI 6%
grp02 ITU-I 9%
grp03 ITU-N 12%
grp04 ANSI 15%
grp05 ANSI 15%
grp10 ANSI 15%
grp15 ANSI 15%

```

If the desired CSPC group is shown in the `rtrv-cspc` output, re-enter the `rtrv-cspc` command with the CSPC group name. For this example, enter these commands.

```
rtrv-cspc:grp=grp05
```

This is an example of the possible output.

```
rlghncxa03w 06-10-25 09:48:31 GMT EAGLE5 36.0.0
CSPC GRP      PCA
grp05         005-005-005
              007-007-007
              008-008-008
              009-009-009
```

```
rtrv-cspc:grp=grp10
```

This is an example of the possible output.

```
rlghncxa03w 06-10-25 09:59:31 GMT EAGLE5 36.0.0
CSPC GRP      PCA
grp10         003-003-003
              004-004-004
              008-008-008
              009-009-009
```

```
rtrv-cspc:grp=grp15
```

This is an example of the possible output.

```
rlghncxa03w 06-10-25 09:48:31 GMT EAGLE5 36.0.0
CSPC GRP      PCA
grp15         005-005-005
              006-006-006
              008-008-008
              009-009-009
```

 **Note:**

If the ANSI/ITU SCCP Conversion feature is enabled, then point codes of multiple network types can be displayed in the `rtrv-cspc` output, if point codes of multiple network types are assigned to the CSPC group.

If the CSPC group is not in the database, or if the required point code is not assigned to the CSPC group, perform the [Adding a Concerned Signaling Point Code](#) procedure and add the required CSPC group or point code to the database.

 **Note:**

If the output of the `rtrv-cspc` command performed in [6](#) shows CSPC groups containing a mixture of point code types, or if the new CSPC group that was added in [6](#) contains a mixture of point code types, continue the procedure with [8](#).

7. The format of the point codes in the CSPC group specified with the `grp` parameter must be the same as the primary point code specified with the `ent-map` command only if the ANSI/ITU SCCP Conversion feature is not enabled.

If the ANSI/ITU SCCP Conversion feature is enabled, the CSPC group may contain a mixture of point code types (refer to the [Adding a Concerned Signaling Point Code](#) procedure), and the network type of the CSPC group can be different from the network type of the primary point code of the mated application.

Verify the status of the ANSI/ITU SCCP Conversion feature by entering this command.

```
rtrv-ctrl-feat:partnum=893012001
```

The following is an example of the possible output.

```
rlghncxa03w 06-10-28 21:15:37 GMT EAGLE5 36.0.0
```

The following features have been permanently enabled:

Feature Name	Partnum	Status	Quantity
SCCP Conversion	893012001	on	----

The following features have been temporarily enabled:

Feature Name	Partnum	Status	Quantity	Trial Period Left
Zero entries found.				

The following features have expired temporary keys:

Feature Name	Partnum
Zero entries found.	

If the ANSI/ITU SCCP Conversion feature is not enabled, perform the [Activating the ANSI/ITU SCCP Conversion Feature](#) procedure to enable the ANSI/ITU SCCP Conversion feature.

8. If the `MAPSET` column is shown in the `rtrv-map` output in [1](#), the Flexible GTT Load Sharing feature is enabled. Continue the procedure with [9](#).

If the `MAPSET` column is not shown in [1](#) and you do not wish to provision MAP sets in this procedure, continue the procedure with [9](#).

If the `MAPSET` column is not shown in [1](#) and you wish to provision MAP sets in this procedure, perform the [Activating the Flexible GTT Load Sharing Feature](#) procedure to enable the Flexible GTT Load Sharing feature. After the Flexible GTT Load Sharing feature is enabled, continue the procedure with [9](#).

 **Note:**

If you do not wish to assign weight and in-service threshold values to the MAP entries in the MAP group or MAP set, continue the procedure with [10](#).

9. If you wish to assign weight and in-service threshold values to the entries in the MAP group or MAP set, and the `WT`, `%WT`, and `THR` columns are shown in the `rtrv-map` output in [1](#), then the Weighted GTT Load Sharing feature is enabled and turned on.

If the WT, %WT, and THR columns are not shown in the `rtrv-map` output in 1, perform the [Activating the Weighted GTT Load Sharing Feature](#) procedure to enable and turn on the Weighted GTT Load Sharing feature.

If the Weighted GTT Load Sharing feature is enabled and turned on, or the [Activating the Weighted GTT Load Sharing Feature](#) procedure was performed in this step, continue this procedure by performing one of these steps.

- If only one of the point codes that will be specified for the mated application is assigned to other mated applications, perform 10 for the new point code that is not assigned to other mated applications.
- If the both point codes that will be specified for the mated application are point codes assigned to other mated applications, continue the procedure by performing one of these steps.
 - If the `mrnset` and `mrnpc` parameters will be specified for the mated application, continue the procedure with 13.
 - If the `mrnset` and `mrnpc` parameters will not be specified for the mated application, continue the procedure by performing one of these steps.
 - * If a new mated application is being added, continue the procedure with 14.
 - * If an entry is being added to an existing mated application, continue the procedure with 15.

10. Display the destination point codes in the database by entering the `rtrv-dstn` command. This is an example of the possible output.

```
rlghncxa03w 10-12-10 11:43:04 GMT EAGLE5 43.0.0
Extended Processing Time may be Required
```

```

      DPCA          CLLI          BEI ELEI  ALIASI
ALIASN/N24  DMN
      001-207-000  ----- no  --- -----
-----
              SS7
      001-001-001  ----- no  --- -----
-----
              SS7
      001-001-002  ----- no  --- -----
-----
              SS7
      001-005-000  ----- no  --- -----
-----
              SS7
      001-007-000  ----- no  --- -----
-----
              SS7
      008-012-003  ----- no  --- -----
-----
              SS7
      003-002-004  ----- no  --- -----
-----
              SS7
      009-002-003  ----- no  --- -----
-----
              SS7
      010-020-005  ----- no  --- -----
-----
              SS7

      DPCI          CLLI          BEI ELEI  ALIASA
ALIASN/N24  DMN
      1-207-0      ----- no  --- -----
-----
              SS7
```

```

0-015-0      ----- no  --- -----
-----      SS7
0-017-0      ----- no  --- -----
-----      SS7
1-011-1      ----- no  --- -----
-----      SS7
1-011-2      ----- no  --- -----
-----      SS7

```

```

Destination table is (14 of 2000) 1% full
Alias table is (0 of 12000) 0% full
PPC table is (1 of 20) 5% full

```

If the required point code is not shown in the `rtrv-dstn` output, perform the "Adding a Destination Point Code" procedure in *Database Administration - SS7 User's Guide* to add the required point code. A proxy point code cannot be assigned to the point code.

After the new point code has been added, skip [11](#) and [12](#), and perform one of the Adding a Route procedures in *Database Administration - SS7 User's Guide* and add the required route to the database. After the route has been added, continue the procedure by performing one of these steps.

- If the `mrnset` and `mrnpc` parameters will be specified for the mated application, continue the procedure with [13](#).
 - If the `mrnset` and `mrnpc` parameters will not be specified for the mated application, continue the procedure by performing one of these steps.
 - If a new mated application is being added, continue the procedure with [14](#).
 - If an entry is being added to an existing mated application, continue the procedure with [15](#).
- 11.** Display the point code that will be assigned to the mated application by using the `rtrv-dstn` command and specifying the point code. For this example, enter this command.

```
rtrv-dstn:dpca=010-020-005
```

This is an example of the possible output.

```
rlghncxa03w 10-12-10 11:43:04 GMT EAGLE5 43.0.0
```

```

      DPCA          CLLI          BEI ELEI   ALIASI
ALIASN/N24      DMN
      010-020-005 ----- no  --- -----
-----      SS7

      PPCA          NCAI PRX      RCAUSE NPRST SPLITIAM HMSMSC HMSCP
SCCPMSGCNV
      009-002-003 ---- no      50      on      20      no      no      none

```

```

Destination table is (14 of 2000) 1% full
Alias table is (0 of 12000) 0% full
PPC table is (1 of 20) 5% full

```

If the point code is not shown in the `rtrv-dstn` command output, the following output is displayed.

```
rlghncxa03w 09-05-10 11:43:04 GMT EAGLE5 41.0.0
```

No destinations meeting the requested criteria were found

Destination table is (14 of 2000) 1% full

Alias table is (0 of 12000) 0% full

PPC table is (1 of 20) 5% full

A proxy point code (a point code value is shown in the `PPC` column) cannot be assigned to the point code. If a proxy point code is shown in this step, choose another point code from the `rtrv-dstn` output in the previous step and repeat this step.

After the new point code has been added, skip [12](#) and perform one of the Adding a Route procedures in *Database Administration - SS7 User's Guide* and add the required route to the database. After the route has been added, continue the procedure by performing one of these steps.

- If the `mrnset` and `mrnpc` parameters will be specified for the mated application, continue the procedure with [13](#).
- If the `mrnset` and `mrnpc` parameters will not be specified for the mated application, continue the procedure by performing one of these steps.
 - If a new mated application is being added, continue the procedure with [14](#).
 - If an entry is being added to an existing mated application, continue the procedure with [15](#).

- 12.** Enter the `rtrv-rte` command with the `dpc` parameter specifying the point codes to be used with the `ent-map` or `chg-map` commands to verify whether or not the point code is the DPC of a route.

For this example, enter these commands.

```
rtrv-rte:dPCA=008-008-008
```

This is an example of the possible output.

```
rlghncxa03w 06-10-07 11:43:04 GMT EAGLE5 36.0.0
  DPCA          ALIASI          ALIASN/N24    LSN          RC          APCA
  008-008-008  -----
008-008-008                                     ls20         10
                                                    RTX:No  CLLI=ls20clli
```

```
rtrv-rte:dPCA=031-049-100
```

This is an example of the possible output.

```
rlghncxa03w 06-10-07 11:43:04 GMT EAGLE5 36.0.0
  DPCA          ALIASI          ALIASN/N24    LSN          RC          APCA
  031-049-100  -----
031-049-100                                     ls10         10
                                                    RTX:No  CLLI=ls10clli
```

```
rtrv-rte:dpca=056-113-200
```

This is an example of the possible output.

```
rlghncxa03w 06-10-07 11:43:04 GMT EAGLE5 36.0.0
  DPCA          ALIASI      ALIASN/N24    LSN          RC    APCA
  056-113-200  -----  -----      ls12         10
056-113-200
                                           RTX:No  CLLI=ls12clli
```

```
rtrv-rte:dpca=179-183-050
```

This is an example of the possible output.

```
rlghncxa03w 06-10-07 11:43:04 GMT EAGLE5 36.0.0
  DPCA          ALIASI      ALIASN/N24    LSN          RC    APCA
  179-183-050  -----  -----      ls18         10
179-183-050
                                           RTX:No  CLLI=ls18clli
```

```
rtrv-rte:dpca=200-147-100
```

This is an example of the possible output.

```
rlghncxa03w 06-10-07 11:43:04 GMT EAGLE5 36.0.0
  DPCA          ALIASI      ALIASN/N24    LSN          RC    APCA
  200-147-100  -----  -----      ls19         10
200-147-100
                                           RTX:No  CLLI=ls19clli
```

If the point code is not shown in the `rtrv-rte` output, perform one of the Adding a Route procedures in *Database Administration - SS7 User's Guide* and add the required route to the database.

Continue the procedure by performing one of these steps.

- If the `mrnset` and `mrnpc` parameters will be specified for the mated application, continue the procedure with [13](#).
 - If the `mrnset` and `mrnpc` parameters will not be specified for the mated application, continue the procedure by performing one of these steps.
 - If a new mated application is being added, continue the procedure with [14](#).
 - If an entry is being added to an existing mated application, continue the procedure with [15](#).
- 13.** The MRN point code value must be assigned to an MRN set. The MRN set must be shown in the `rtrv-mrn` output. Display the MRN sets by entering the `rtrv-mrn` command. This is an example of the possible output.

```
rlghncxa03w 09-02-07 00:34:31 GMT EAGLE5 40.1.0

  MRNSET MAPSET  MAPPCC          MAPSSN      PC          RC WT
%WT THR
  DFLT   7      002-002-007      50      005-005-005  10 10
14   1
```

14	1				006-001-001	10 10
28	1				006-001-002	10 20
42	1				006-001-003	10 30
23	1				006-001-004	20 40
23	1				006-001-005	20 40
23	1				006-001-006	20 40
29	1				006-001-007	20 50

	MRNSET	MAPSET	MAPPC	MAPSSN	PC	RC	WT
%WT	THR						
1		-----	-----	---	007-007-007	10	10
14	1				008-001-001	10	10
14	1				008-001-002	10	20
28	1				008-001-003	10	30
42	1				008-001-004	20	40
23	1				008-001-005	20	40
23	1				008-001-006	20	40
23	1				008-001-007	20	50

MRN table is (16 of 5990) 1% full

If any of the following items are not shown in the `rtrv-mrn` output, then the feature corresponding to these items is not enabled, or turned on if required.

- The `MRNSET` field - the Flexible GTT Load Sharing feature is not enabled.
- The `MAPSET`, `MAPPC` and `MAPSSN` fields - the GTT Load Sharing with Alternate Routing Indicator feature is not enabled.
- The `WT`, `%WT`, `THR` columns - the Weighted GTT Load Sharing feature is not enabled and turned on.

 **Note:**

The network type of the `pc/pca/pci/pcn/pcn24` and `mrnpc/mrnpca/mrnpai/mrnpai24` parameter values must be compatible, as shown in Note 9 in [Table 2-49](#) or in Note 10 in [Table 2-50](#).

If the MRN set that you wish to use, containing the desired point code, is not shown in the `rtrv-mrn` output, add the required MRN set by performing the [Provisioning MRN Entries](#) procedure.

If the MRN set that you wish to use is shown in the `rtrv-mrn` output, or the [Provisioning MRN Entries](#) procedure was performed in this step, continue the procedure by performing one of these steps.

- If a new mated application is being added, continue the procedure with [14](#).
 - If an entry is being added to an existing mated application, continue the procedure with [15](#).
- 14.** Add the mated application to the database using the `ent-map` command. Use [Table 2-49](#) as a guide for the parameters and values that can be specified with the `ent-map` command.

Table 2-49 Combined Dominant/Load Shared Mated Application Parameter Combinations for the ENT-MAP Command

Mandatory Parameters
:pc/pca/pci/pcn/pcn24=<ANSI, ITU-I, ITU-I spare, ITU-N, ITU-N spare, or ITU-N24 point code from the rtrv-rte or rtrv-map outputs> (See Notes 6 and 9))
:ssn=<subsystem number, 2 - 255>
:rc=<0 - 99> (See Note 1)
:mpc/mpca/mpci/mpcn/mpcn24=<ANSI, ITU-I, ITU-I spare, ITU-N, ITU-N spare, or ITU-N24 point code of the mate from the rtrv-rte or rtrv-map outputs> (See Notes 3, 6, and 9)
:mssn=<subsystem number of the mate, 2 - 255>
:materc=<0 - 99> (See Note 1)
Optional Parameters
:wt=<1 - 99> (See Note 5)
:mwt=<1 - 99> (See Note 5)
:thr=<1 - 100> (See Note 5)
:grp=<CSPC group name> (See Note 2)
:sso=<on, off>
:srm=<yes, no> (See Note 7)
:mrc=<yes, no> (See Note 7)
:mapset=<new, dflt> (See Note 4)
:mrnset = <MRN set ID from the rtrv-mrn output> (See Note 8)
:mrnpc/mrnpca/mrnpcci/mrnpccn/mrnpccn24=<the point code value in the MRN set> (See Notes 8 and 9)

Table 2-49 (Cont.) Combined Dominant/Load Shared Mated Application Parameter Combinations for the ENT-MAP Command**Notes:**

- a. The combined dominant/load shared mated application must contain a minimum of two entries with RC values that are equal and a minimum of one entry with an RC value that is different.
- b. The format of the point codes in the CSPC group specified with the `grp` parameter must be the same as the primary point code specified with the `ent-map` command only if the ANSI/ITU SCCP Conversion feature is not enabled. If the ANSI/ITU SCCP Conversion feature is enabled, the CSPC group may contain a mixture of point code types (refer to the [Adding a Concerned Signaling Point Code](#) procedure), and the network type of the CSPC group can be different from the network type of the primary point code of the mated application.
- c. For mated applications containing ANSI or 24-bit ITU-N point codes, the format of the point codes specified in the `ent-map` command must be the same. For example, if the primary point code is a 24-bit ITU-N point code (`pcn24`), the mate point code must be a 24-bit ITU-N point code (`mpcn24`). The mate point codes of mated applications containing either ITU-I, ITU-I spare, 14-bit ITU-N, or 14-bit ITU-N spare primary point codes do not have to be the same format as the primary point code. The mate point codes of these mated applications can be a mixture of ITU-I, ITU-I spare, 14-bit ITU-N, or 14-bit ITU-N spare point codes.
- d. If the Flexible GTT Load Sharing is enabled, the `mapset` parameter must be specified with the `ent-map` command. If the Flexible GTT Load Sharing is not enabled, the `mapset` parameter cannot be specified with the `ent-map` command.
To provision entries in the default MAP set, the `mapset=dflt` parameter must be specified with the `ent-map` command.
To provision entries in a new MAP set, the `mapset=new` parameter must be specified with the `ent-map` command. The `mapset=new` parameter can be specified only with the `ent-map` command. When the `ent-map` command is executed with the `mapset=new` parameter, the new MAP set ID is automatically generated and displayed in the output of the `ent-map` command as follows.

New MAPSET Created : MAPSETID = <new MAP set ID>

A MAP set, other than the default MAP set, is a MAP group provisioned with the MAP set ID and can contain a maximum of 128 point code and subsystem entries. The default MAP set can contain multiple MAP groups. Each group in the default MAP set can contain a maximum of 128 point code and subsystem entries. The point code and subsystem entry can appear only once in the default MAP set, so the point code and subsystem entry can appear in only one MAP group in the default MAP set. The point code and subsystem entry provisioned in a MAP set can be provisioned in multiple MAP sets. If a point code and subsystem entry is provisioned in different MAP sets, the relative cost value of the entry in each MAP set can be different. All the point code and subsystem entries in a MAP set, including the default MAP set, must be different.
- e. Refer to the [Provisioning Weights and In-Service Thresholds for Mated Applications](#) section for information about using the weight (`wt` and `mwt`) and in-service threshold (`thr`) parameters.
- f. If the point code selected from either the `rtrv-rte` or `rtrv-map` outputs is a 14-bit ITU-N point code, then the `pcn/mpcn` parameters must be specified. If the

Table 2-49 (Cont.) Combined Dominant/Load Shared Mated Application Parameter Combinations for the ENT-MAP Command

	point code selected from either the <code>rtrv-rte</code> or <code>rtrv-map</code> outputs is a 24-bit ITU-N point code, then the <code>pcn24/mpcn24</code> parameters must be specified.
g.	The <code>srm=yes</code> parameter can be specified only for combined dominant/load shared mated applications containing ANSI point codes. The <code>mrc</code> parameter can be specified for a combined dominant/load shared mated application, but this parameter affects traffic only for a dominant mated application. These are the default values for the <code>srm</code> and <code>mrc</code> parameters. <ul style="list-style-type: none"> • ANSI mated applications - <code>srm=yes, mrc=yes</code> • ITU mated applications - <code>srm=no, mrc=no</code>
h.	The <code>mrnset</code> and <code>mrnpc/mrnpca/mrnpci/mrnpn/mrnpn24</code> parameters can be specified only if the GTT Load Sharing with Alternate Routing Indicator feature is enabled. Refer to the Activating the GTT Load Sharing with Alternate Routing Indicator Feature procedure for information about enabling the GTT Load Sharing with Alternate Routing Indicator feature. The <code>mrnset</code> and <code>mrnpc/mrnpca/mrnpci/mrnpn/mrnpn24</code> values must be shown in the <code>rtrv-mrn</code> output.
i.	The network type of the <code>pc/pca/pci/pcn/pcn24</code> and <code>mrnpc/mrnpca/mrnpci/mrnpn/mrnpn24</code> parameter values must be compatible, as shown in Table 2-48 .

If the Flexible GTT Load Sharing feature is not enabled for this example, enter these commands.

```
ent-
map:pca=008-008-008:ssn=254:rc=10:mpc=200-147-100:mssn=254 :m
aterc=10:grp=grp10:sso=on:wt=10:mwt=30:thr=50

ent-
map:pci=5-005-5:ssn=50:rc=10:mpcn=0257:mssn=50:materc=10 :grp
=grp20:mrc=yes:sso=off
```

When each of these commands have successfully completed, this message should appear.

```
rlghncxa03w 06-10-07 11:44:13 GMT EAGLE5 36.0.0
ENT-MAP: MASP A - COMPLTD
```

If the Flexible GTT Load Sharing feature is enabled for this example, enter these commands.

```
ent-
map:pca=008-008-008:ssn=254:rc=10:mpc=200-147-100:mssn=254 :m
aterc=10:grp=grp10:sso=on:mapset=new:wt=10:mwt=30:thr=50

ent-
map:pci=5-005-5:ssn=50:rc=10:mpcn=0257:mssn=50:materc=10 :grp
=grp20:mrc=yes:sso=off:mapset=new
```

If the GTT Load Sharing with Alternate Routing Indicator feature is enabled for this example, enter this command.

```
ent-
map:pca=008-008-008:ssn=254:rc=10:mpc=200-147-100:mssn=254 :m
```

```
aterc=10:grp=grp10:sso=on:mapset=new:wt=10:mwt=30:thr=50 :mrn
set=1:mrnpc=007-007-007
```

If the Flexible GTT Load Sharing feature is enabled when each of these commands have successfully completed, and a new MAP set was created, a message similar to the following should appear.

```
rlghncxa03w 06-10-07 11:44:13 GMT EAGLE5 36.0.0
New MAPSET Created : MAPSETID = 10
ENT-MAP: MASP A - COMPLTD
```

If the Flexible GTT Load Sharing feature is enabled when each of these commands have successfully completed, and the mated application was added to the default MAP set, this message should appear.

```
rlghncxa03w 06-10-07 11:44:13 GMT EAGLE5 36.0.0
ENT-MAP: MASP A - COMPLTD
```

If no other entries are being added to the mated application, continue the procedure with [16](#).

If other entries are being added to the mated application, continue the procedure with [15](#).

15. Add the mated point code and subsystem to the mated application using the `chg-map` command. Use [Table 2-50](#) as a guide for the parameters and values that can be specified with the `chg-map` command.

Table 2-50 Combined Dominant/Load Shared Mated Application Parameter Combinations for the CHG-MAP Command

Mandatory Parameters
:pc/pca/pci/pcn/pcn24=<ANSI, ITU-I, ITU-I spare, ITU-N, ITU-N spare, or ITU-N24 point code from the <code>rtrv-rte</code> or <code>rtrv-map</code> outputs> (See Notes 6 and 10)
:ssn=<subsystem number>
:mpc/mpca/mpci/mpcn/mpcn24=<ANSI, ITU-I, ITU-I spare, ITU-N, ITU-N spare, or ITU-N24 point code of the mate from the <code>rtrv-rte</code> or <code>rtrv-map</code> outputs> (See Notes 3, 6, and 10)
:mssn=<subsystem number of the mate, 2 - 255>
:materc=<0 - 99> (See Note 1)
Optional Parameters
:wt=<1 - 99> (See Note 5)
:mwt=<1 - 99> (See Note 5)
:grp=<CSPC group name> (See Notes 2 and 8)
:sso=<on, off> (See Note 8)
:srm=<yes, no> (See Notes 7 and 8)
:mrc=<yes, no> (See Notes 7 and 8)
:mapset=<dflt or the number of an existing MAP set> (See Note 4)
:mrnset = <MRN set ID from the <code>rtrv-mrn</code> output> (See Note 9)
:mrnpc/mrnpc/mrnpci/mrnpcn/mrnpcn24=<the point code value in the MRN set> (See Notes 9 and 10)

Table 2-50 (Cont.) Combined Dominant/Load Shared Mated Application Parameter Combinations for the CHG-MAP Command

Notes:	
a.	The combined dominant/load shared mated application must contain a minimum of two entries with RC values that are equal and a minimum of one entry with an RC value that is different.
b.	The format of the point codes in the CSPC group specified with the <code>grp</code> parameter must be the same as the primary point code specified with the <code>chg-map</code> command only if the ANSI/ITU SCCP Conversion feature is not enabled. If the ANSI/ITU SCCP Conversion feature is enabled, the CSPC group may contain a mixture of point code types (refer to the Adding a Concerned Signaling Point Code procedure), and the network type of the CSPC group can be different from the network type of the primary point code of the mated application.
c.	For mated applications containing ANSI or 24-bit ITU-N point codes, the format of the point codes specified in the <code>chg-map</code> command must be the same. For example, if the primary point code is a 24-bit ITU-N point code (<code>pcn24</code>), the mate point code must be a 24-bit ITU-N point code (<code>mpcn24</code>). The mate point codes of mated applications containing either ITU-I, ITU-I spare, 14-bit ITU-N, or 14-bit ITU-N spare primary point codes do not have to be the same format as the primary point code. The mate point codes of these mated applications can be a mixture of ITU-I, ITU-I spare, 14-bit ITU-N, or 14-bit ITU-N spare point codes.
d.	<p>If the Flexible GTT Load Sharing is enabled, the <code>mapset</code> parameter must be specified with the <code>chg-map</code> command.</p> <p>If the Flexible GTT Load Sharing is not enabled, the <code>mapset</code> parameter cannot be specified with the <code>chg-map</code> command.</p> <p>To provision entries in the default MAP set, the <code>mapset=deflt</code> parameter must be specified with the <code>chg-map</code> command.</p> <p>To provision entries in an existing MAP set, the <code>mapset</code> parameter must be specified with the MAP set ID value of that MAP set.</p> <p>A MAP set, other than the default MAP set, is a MAP group provisioned with the MAP set ID and can contain a maximum of 128 point code and subsystem entries.</p> <p>The default MAP set can contain multiple MAP groups. Each group in the default MAP set can contain a maximum of 128 point code and subsystem entries.</p> <p>The point code and subsystem entry can appear only once in the default MAP set, so the point code and subsystem entry can appear in only one MAP group in the default MAP set.</p> <p>The point code and subsystem entry provisioned in a MAP set can be provisioned in multiple MAP sets. If a point code and subsystem entry is provisioned in different MAP sets, the relative cost value of the entry in each MAP set can be different. All the point code and subsystem entries in a MAP set, including the default MAP set, must be different.</p>
e.	Refer to the Provisioning Weights and In-Service Thresholds for Mated Applications section for information about using the weight (<code>wt</code> and <code>mwt</code>) and in-service threshold (<code>thr</code>) parameters.
f.	If the point code selected from either the <code>rtrv-rte</code> or <code>rtrv-map</code> outputs is a 14-bit ITU-N point code, then the <code>pcn/mpcn</code> parameters must be specified. If the point code selected from either the <code>rtrv-rte</code> or <code>rtrv-map</code> outputs is a 24-bit ITU-N point code, then the <code>pcn24/mpcn24</code> parameters must be specified.
g.	The <code>srm=yes</code> parameter can be specified only for combined dominant/load shared mated applications containing ANSI point codes. The <code>mrc</code> parameter can be specified for a combined dominant/load shared mated application, but this parameter affects traffic only for a dominant mated application. These are the default values for the <code>srm</code> and <code>mrc</code> parameters.

Table 2-50 (Cont.) Combined Dominant/Load Shared Mated Application Parameter Combinations for the CHG-MAP Command

<ul style="list-style-type: none"> • ANSI mated applications - <code>srn=yes, mrc=yes</code> • ITU mated applications - <code>srn=no, mrc=no</code> <p>h. The CSPC group name (<code>grp</code>), <code>srn</code>, <code>mrc</code>, or <code>sso</code> values for a specific point code and SSN in a mated application are changed, these parameter values for this specific point code and SSN in all applicable mated applications will be changed to the new values.</p> <p>i. The <code>mrnset</code> and <code>mrnpc/mrnpca/mrnpci/mrnpn/mrnpn24</code> parameters can be specified only if the GTT Load Sharing with Alternate Routing Indicator feature is enabled. Refer to the Activating the GTT Load Sharing with Alternate Routing Indicator Feature procedure for information about enabling the GTT Load Sharing with Alternate Routing Indicator feature. The <code>mrnset</code> and <code>mrnpc/mrnpca/mrnpci/mrnpn/mrnpn24</code> values must be shown in the <code>rtrv-mrn</code> output.</p> <p>j. The network type of the <code>pc/pca/pci/pcn/pcn24</code> and <code>mrnpc/mrnpca/mrnpci/mrnpn/mrnpn24</code> parameter values must be compatible, as shown in Table 2-48.</p>

If the Flexible GTT Load Sharing feature is not enabled for this example, enter these commands.

```
chg-
map:pca=008-008-008:ssn=254:rc=10:mpc=179-183-050:mssn=250 :m
aterc=10:grp=grp15:sso=off:mwt=40
```

```
chg-
map:pca=008-008-008:ssn=254:rc=10:mpca=031-049-100 :mssn=250 :
materc=20:grp=grp15:mrc=yes:srn=yes:sso=on:mwt=60
```

```
chg-
map:pca=008-008-008:ssn=254:rc=10:mpca=056-113-200 :mssn=251 :
materc=20:grp=grp05:mrc=yes:srn=yes:sso=off:mwt=70
```

```
chg-
map:pci=5-005-5:ssn=50:rc=10:mpci=s-5-005-6:mssn=50:materc=20
:grp=grp20:mrc=yes:sso=off
```

```
chg-
map:pci=5-005-5:ssn=50:rc=10:mpci=5-005-1:mssn=50:materc=20 :
grp=grp20:mrc=yes:sso=off
```

When each of these commands have successfully completed, this message should appear.

```
rlghncxa03w 06-10-07 11:44:13 GMT EAGLE5 36.0.0
CHG-MAP: MASP A - COMPLTD
```

If the Flexible GTT Load Sharing feature is enabled for this example, enter these commands.

```
chg-
map:pca=008-008-008:ssn=254:rc=10:mpc=179-183-050:mssn=250 :m
aterc=11:grp=grp15:sso=off:mapset=10:mwt=40
```

```
chg-
map:pca=008-008-008:ssn=254:rc=10:mpca=031-049-100 :mssn=250:
materc=20:grp=grp15:mrc=yes:srm=yes:sso=on:mapset=10:mwt=60
```

```
chg-
map:pca=008-008-008:ssn=254:rc=10:mpca=056-113-200 :mssn=251:
materc=20:grp=grp05:mrc=yes:srm=yes:sso=off :mapset=10:mwt=70
```

```
chg-
map:pci=5-005-5:ssn=50:rc=10:mpci=s-5-005-6:mssn=50:materc=20
:grp=grp20:mrc=yes:sso=off:mapset=11
```

```
chg-
map:pci=5-005-5:ssn=50:rc=10:mpci=5-005-1:mssn=50:materc=20 :
grp=grp20:mrc=yes:sso=off:mapset=11
```

If the GTT Load Sharing with Alternate Routing Indicator feature is enabled for this example, enter this command.

```
chg-
map:pca=008-008-008:ssn=254:rc=10:mpc=179-183-050:mssn=250 :m
aterc=11:grp=grp15:sso=off:mapset=10:mwt=40:mrnset=1:mrnpc=00
7-007-007
```

When each of these commands have successfully completed, this message should appear.

```
rlghncxa03w 06-10-07 11:44:13 GMT EAGLE5 36.0.0
CHG-MAP: MASP A - COMPLTD
```

Repeat this step for all new entries being added to the existing mated application.

If the Flexible GTT Load Sharing feature is not enabled, the mated application can contain a maximum of 128 entries.

If the Flexible GTT Load Sharing feature is enabled, and the MAP set is not the default MAP set, the MAP set can contain a maximum of 128 entries.

If the Flexible GTT Load Sharing feature is enabled, and the MAP set is the default MAP set, the default MAP set can contain multiple MAP groups. Each group in the default MAP set can contain a maximum of 128 point code and subsystem entries.

- Verify the changes using the `rtrv-map` command with the primary point code and subsystem specified in [14](#) and [15](#).

If the `mapset=dflt` parameter was specified in [14](#) and [15](#), the `mapset=dflt` parameter should be specified with the `rtrv-map` command.

If a new MAP set was created in [14](#), the `mapset` parameter should be specified with the `rtrv-map` command. The value for the `mapset` parameter should be the MAP set ID generated in [14](#).

If the mated application was added to an existing MAP set in [15](#), the `mapset` parameter and value specified in [15](#) should be specified with the `rtrv-map` command.

If the Flexible GTT Load Sharing feature is not enabled for this example, enter these commands.

```
rtrv-map:pca=008-008-008:ssn=254
```

This is an example of the possible output.

```
rlghncxa03w 09-07-07 00:34:31 GMT EAGLE5 41.1.0
```

PCA	Mate PCA	SSN	RC	MULT	SRM	MRC	GRP	NAME	SSO	WT	%WT
THR											
008-008-008		254	10	COM	YES	*Y	grp10		ON	10	4
50											
	200-147-100	254	10	COM	YES	*Y	grp10		ON	30	14
50											
	179-183-050	250	10	COM	YES	*Y	grp15		OFF	40	19
50											
	031-049-100	250	20	COM	YES	*Y	grp15		ON	60	28
50											
	056-113-200	251	20	COM	YES	*Y	grp05		OFF	70	33
50											

```
MAP TABLE IS (37 of 1024) 4 % FULL
```

```
rtrv-map:pci=5-005-5:ssn=50
```

This is an example of the possible output.

```
rlghncxa03w 09-07-07 00:34:31 GMT EAGLE5 41.1.0
```

PCI	NET	Mate PC	SSN	RC	MULT	SRM	MRC	GRP	NAME	SSO	WT	%WT
THR												
5-005-5			50	10	COM	NO	*Y	grp20		OFF	--	
---	---											
	N	0257	50	10	COM	NO	*Y	grp20		OFF	--	
---	---											
	I	s-5-005-6	50	20	COM	NO	*Y	grp20		OFF	--	
---	---											
	I	5-005-1	50	20	COM	NO	*Y	grp20		OFF	--	
---	---											

```
MAP TABLE IS (37 of 1024) 4 % FULL
```

 **Note:**

If the Weighted GTT Load Sharing feature is not enabled or turned on, the WT, %WT, and THR columns are not shown in the `rtrv-map` output.

If the Flexible GTT Load Sharing feature is enabled for this example, enter these commands.

```
rtrv-map:pca=008-008-008:ssn=254:mapset=10
```

This is an example of the possible output.

```
rlghncxa03w 09-07-07 00:34:31 GMT EAGLE5 41.1.0
```

```
MAPSET ID=10 MRNSET ID=----- MRNPC=-----
```



```

PCA          Mate PCA          SSN RC MULT SRM MRC GRP NAME SSO WT
%WT THR
008-008-008          254 10  COM YES *Y  grp10  ON  10
4 50
          200-147-100  254 10  COM YES *Y  grp10  ON  30
14 50
          179-183-050  250 10  COM YES *Y  grp15  OFF 40
19 50
          031-049-100  250 20  COM YES *Y  grp15  ON  60
28 50
          056-113-200  251 20  COM YES *Y  grp05  OFF 70
33 50

```

```
MAP TABLE IS (37 of 36000) 4 % FULL
```

```
rtrv-map:pci=5-005-5:ssn=50:mapset=11
```

This is an example of the possible output.

```
rlghncxa03w 09-07-07 00:34:31 GMT EAGLE5 41.1.0
```

```

MAPSET ID=11      MRNSET ID=----- MRNPC=-----
PCI          NET Mate PC          SSN RC MULT SRM MRC GRP NAME SSO WT
%WT THR
5-005-5          50 10  COM NO  *Y  grp20  OFF --
--- --
          N    0257          50 10  COM NO  *Y  grp20  OFF --
--- --
          I  s-5-005-6          50 20  COM NO  *Y  grp20  OFF --
--- --
          I    5-005-1          50 20  COM NO  *Y  grp20  OFF --
--- --

```

```
MAP TABLE IS (37 of 36000) 4 % FULL
```

If the Weighted GTT Load Sharing feature is not enabled, the WT, %WT, and THR columns are not shown in the `rtrv-map` output.

If the GTT Load Sharing with Alternate Routing Indicator feature is not enabled, the MRNSET and MRNPC fields are not shown in the `rtrv-map` output.

17. Backup the new changes using the `chg-db:action=backup:dest=fixed` command.

These messages should appear, the active Maintenance and Administration Subsystem Processor (MASP) appears first.

```

BACKUP (FIXED) : MASP A - Backup starts on active MASP.
BACKUP (FIXED) : MASP A - Backup on active MASP to fixed disk
complete.
BACKUP (FIXED) : MASP A - Backup starts on standby MASP.
BACKUP (FIXED) : MASP A - Backup on standby MASP to fixed disk
complete.

```

Figure 2-91 Provision a Combined Dominant/Load Shared Mated Application - Sheet 1 of 11

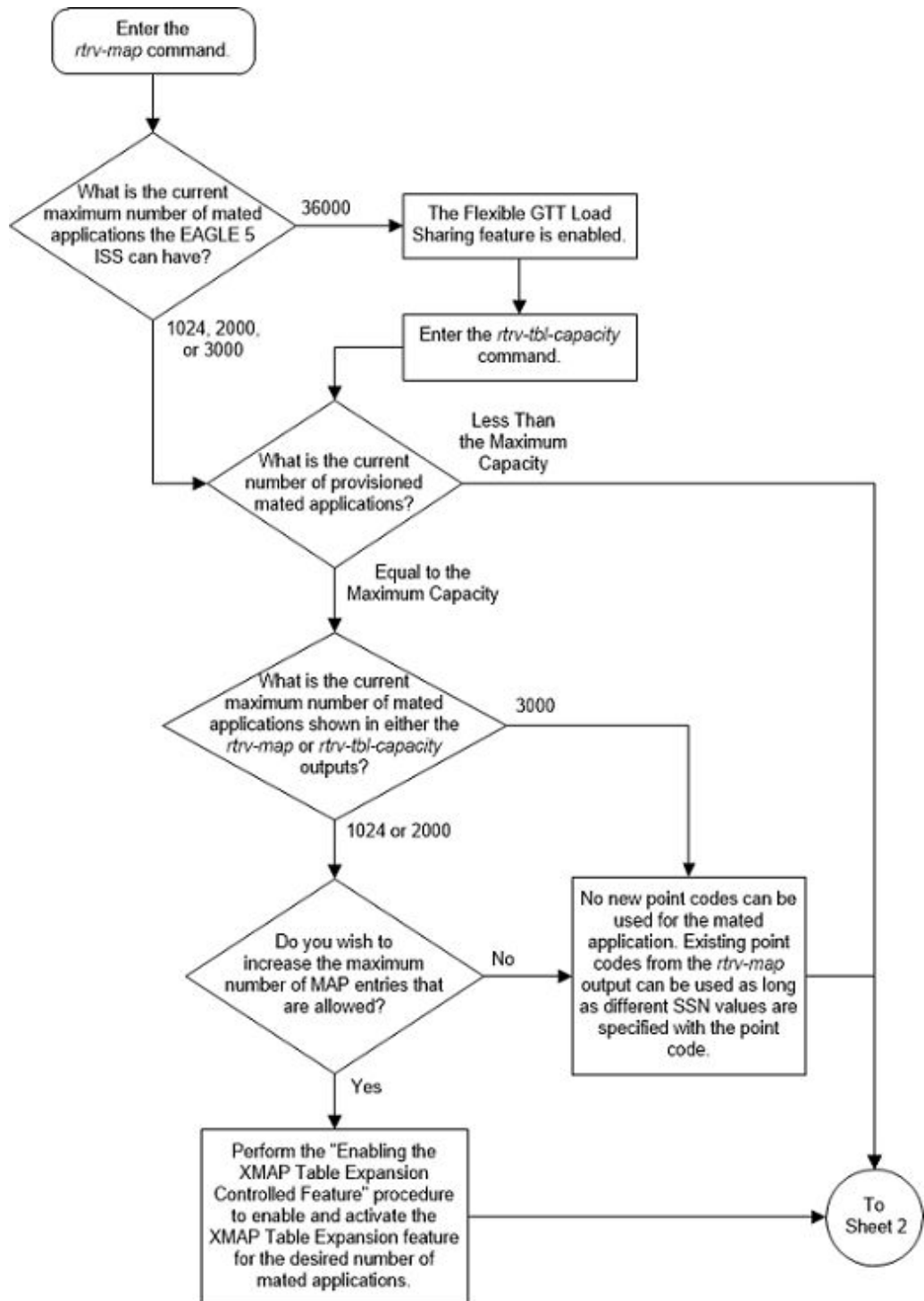

Figure 2-92 Provision a Combined Dominant/Load Shared Mated Application - Sheet 2 of 11

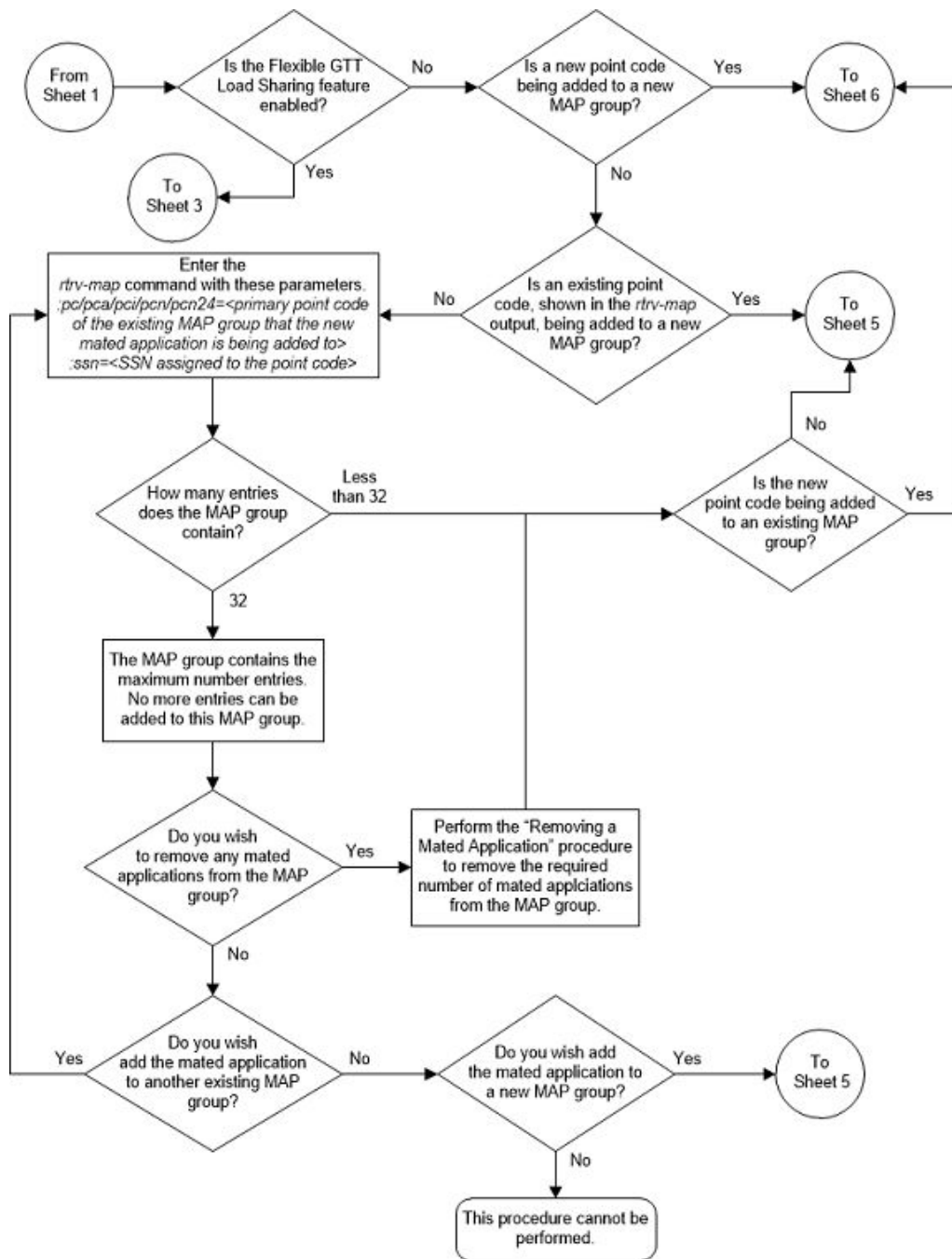

Figure 2-93 Provision a Combined Dominant/Load Shared Mated Application - Sheet 3 of 11

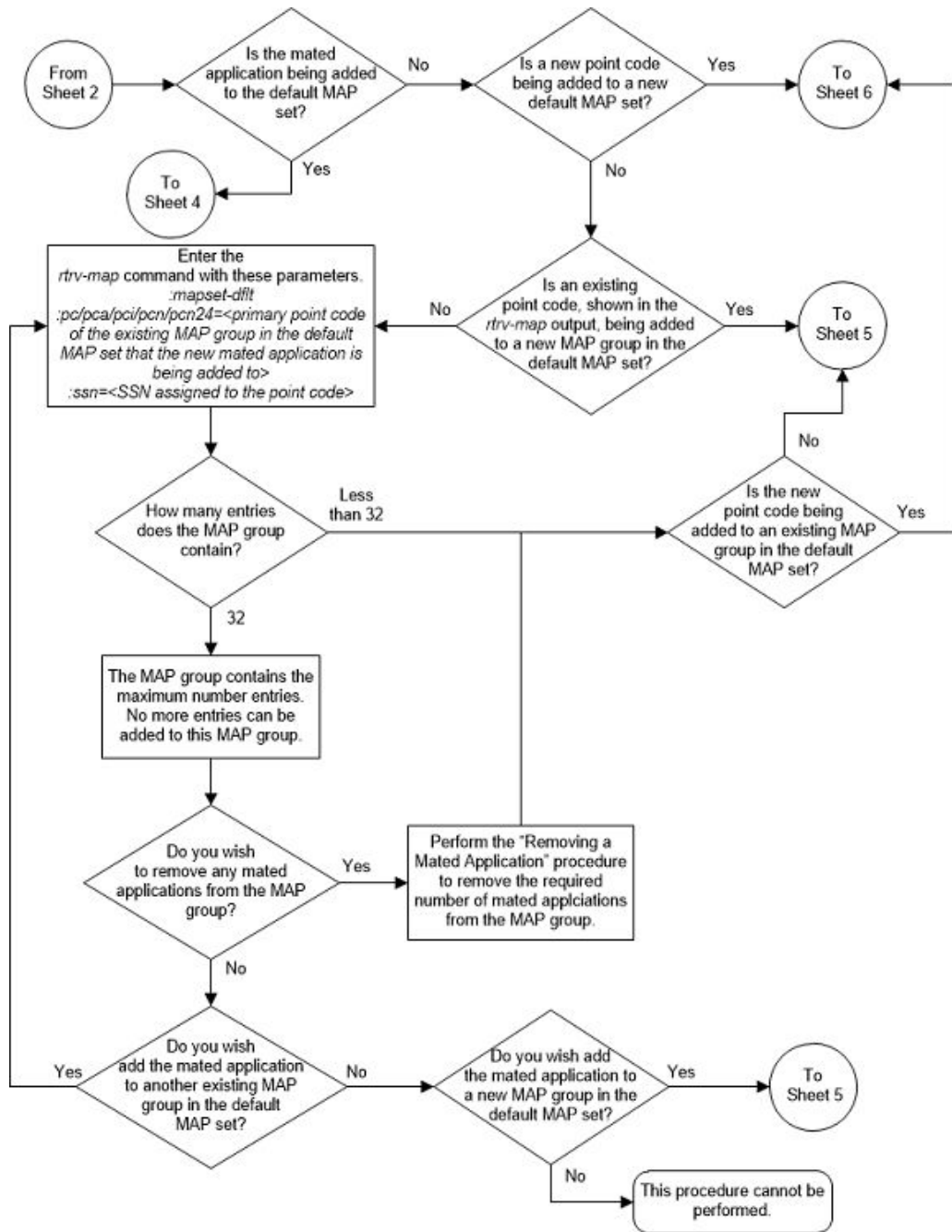

Figure 2-94 Provision a Combined Dominant/Load Shared Mated Application - Sheet 4 of 11

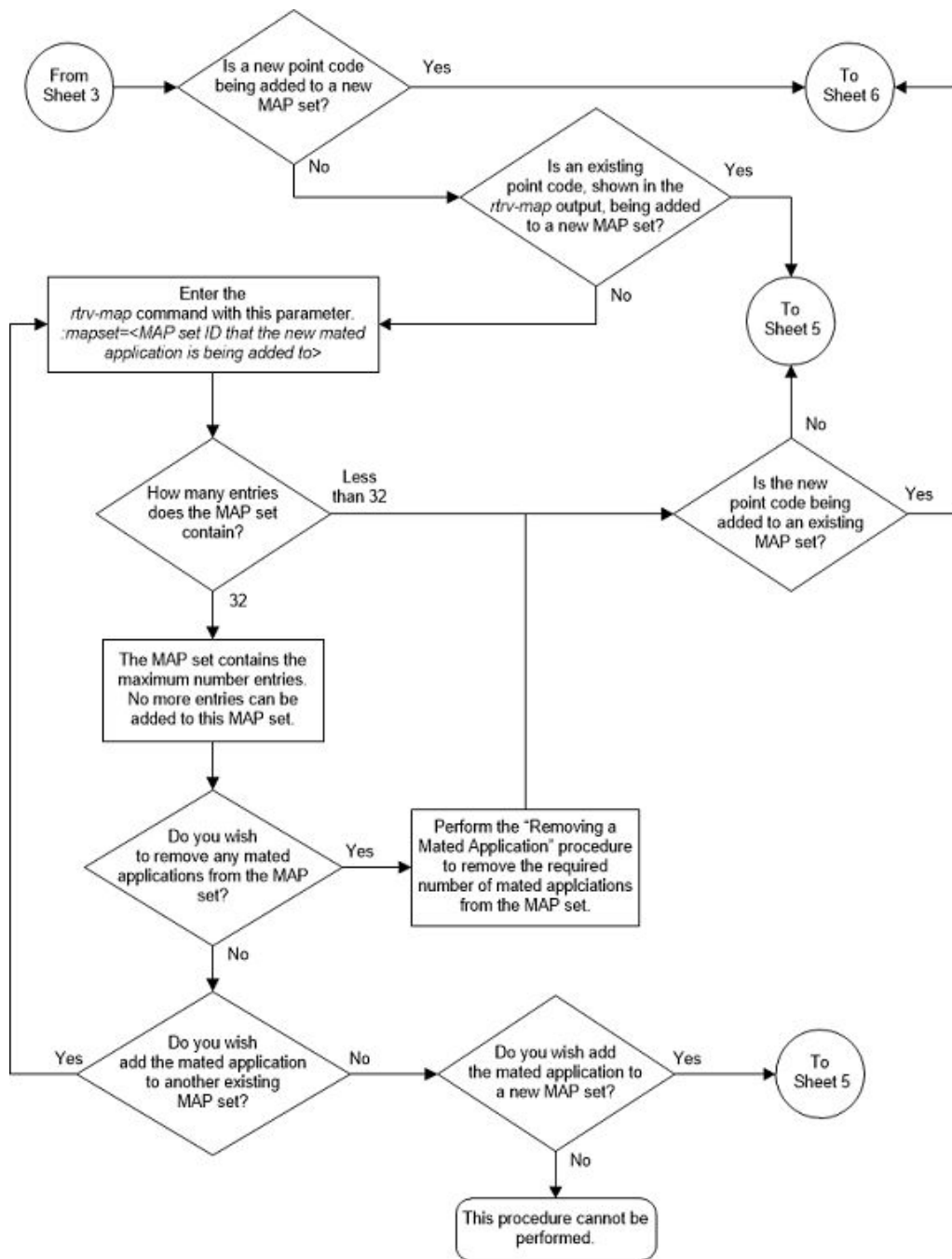

Figure 2-95 Provision a Combined Dominant/Load Shared Mated Application - Sheet 5 of 11

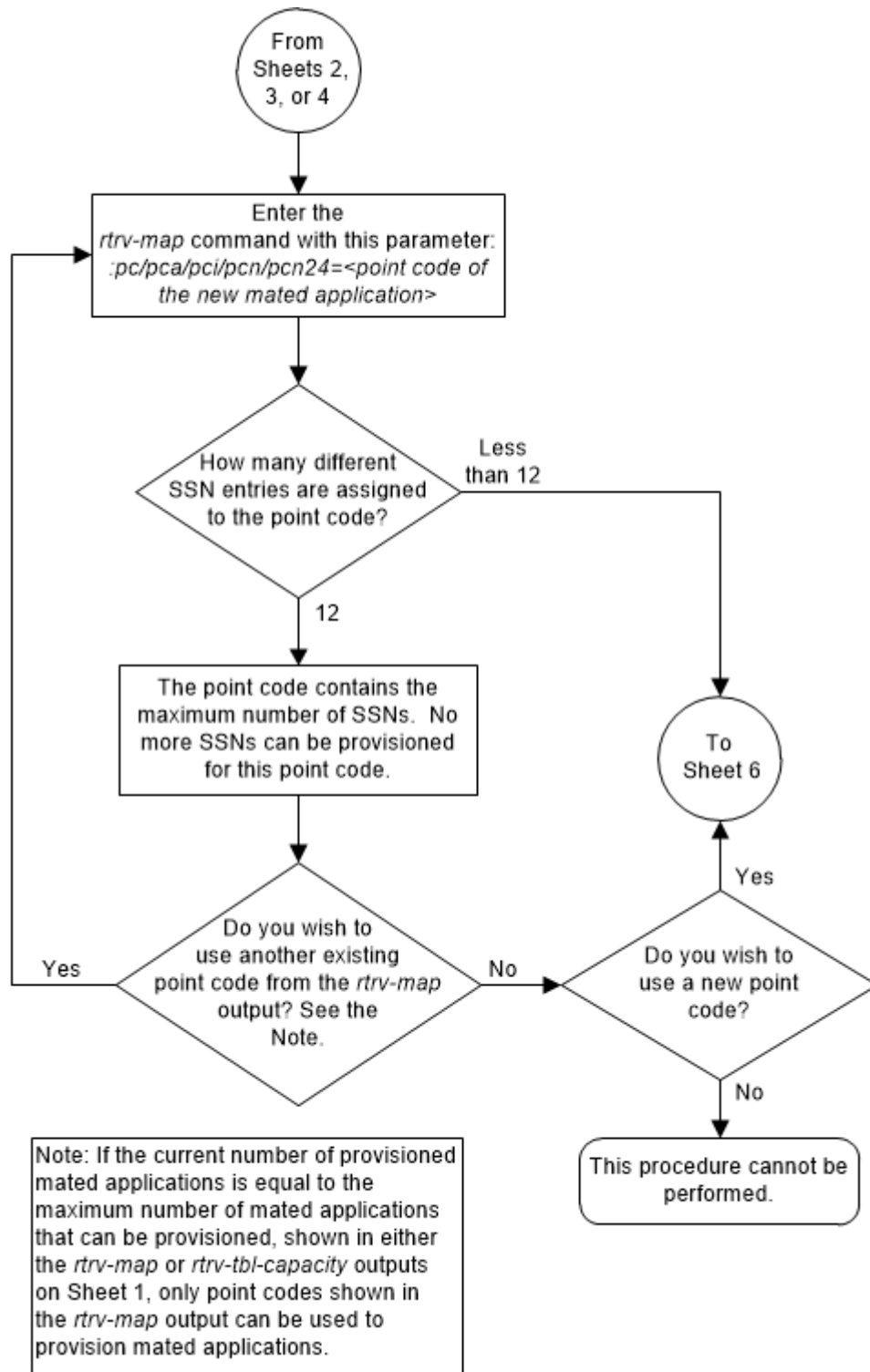

Figure 2-96 Provision a Combined Dominant/Load Shared Mated Application - Sheet 6 of 11

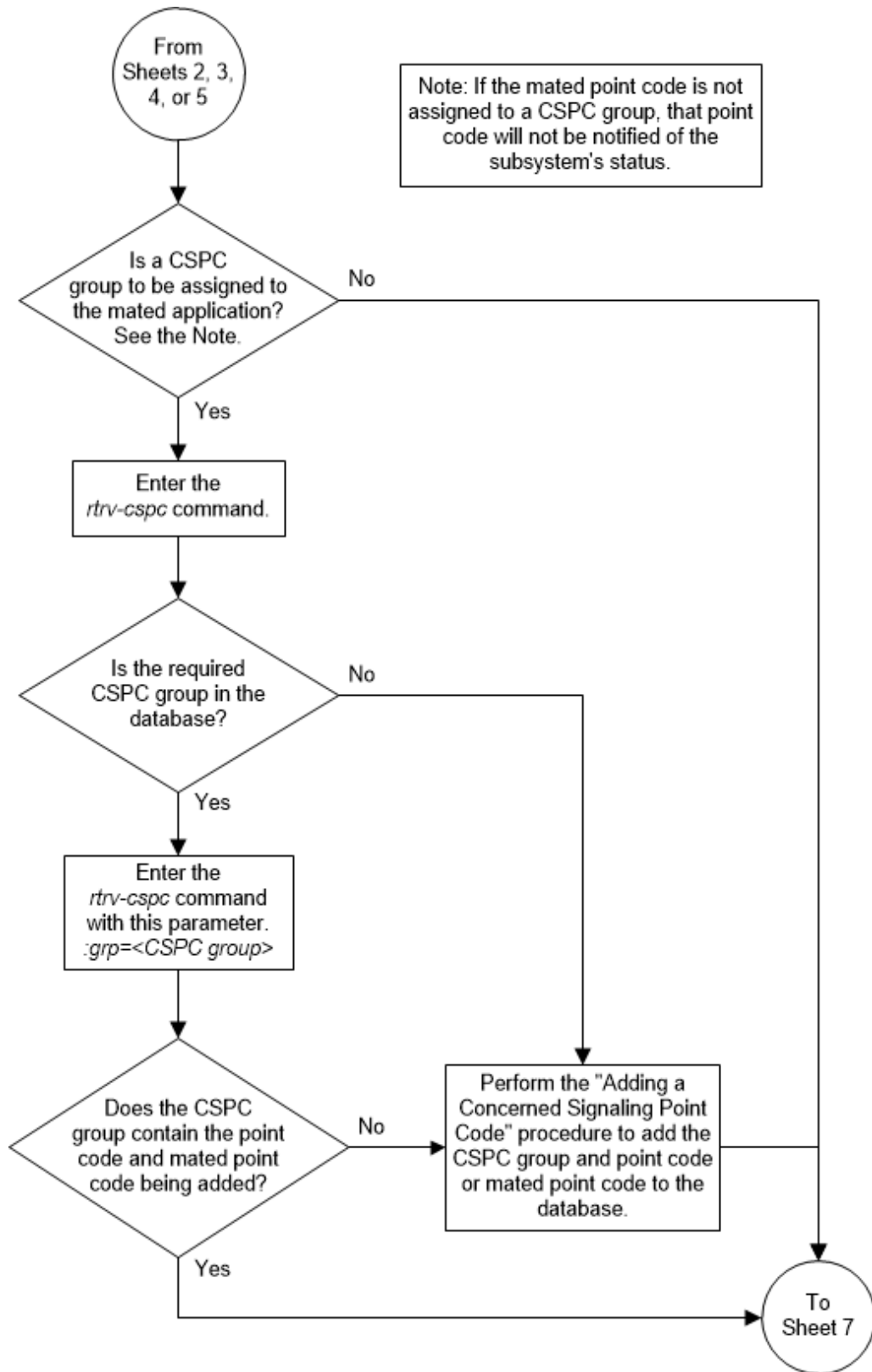

Figure 2-97 Provision a Combined Dominant/Load Shared Mated Application - Sheet 7 of 11

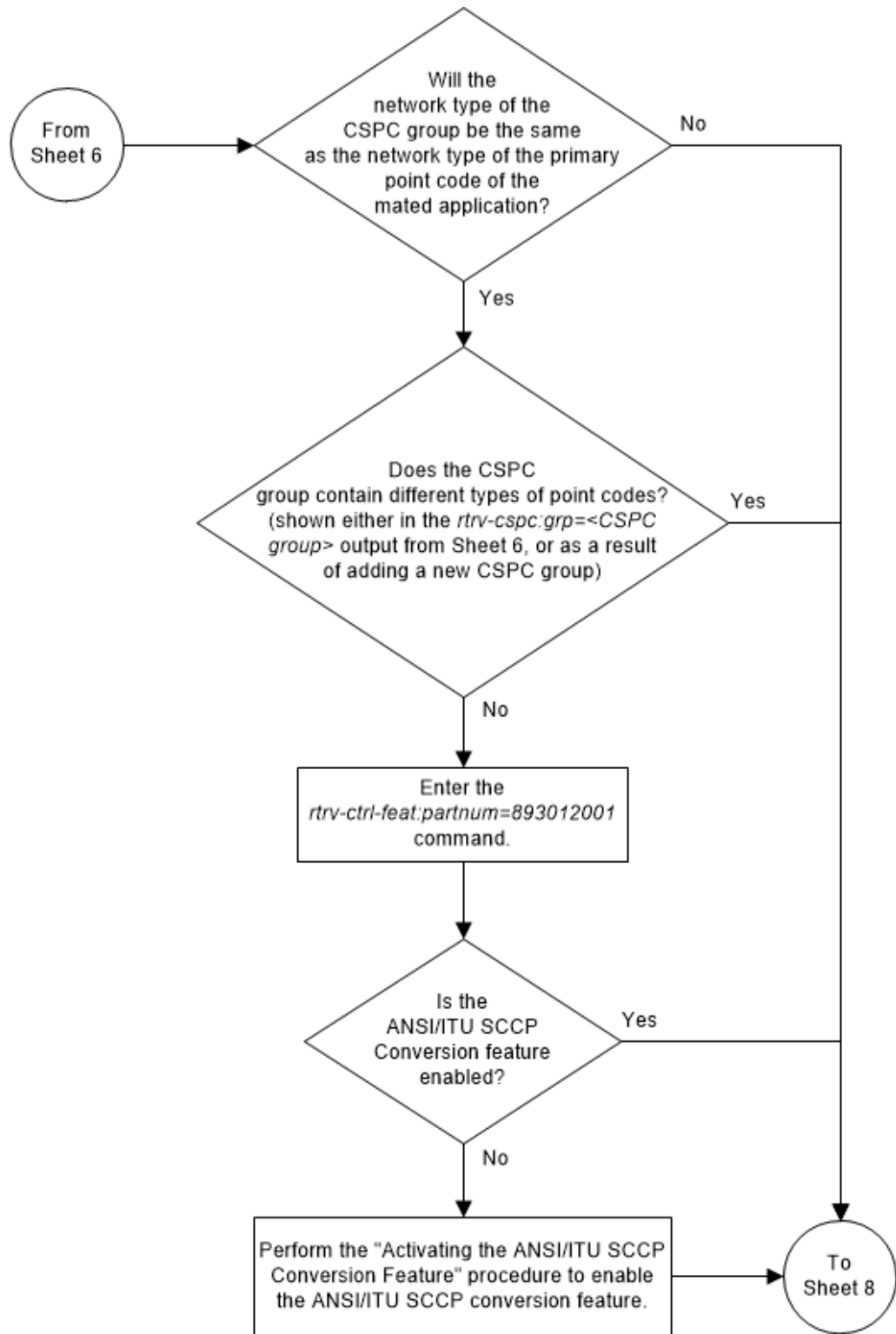

Figure 2-98 Provision a Combined Dominant/Load Shared Mated Application - Sheet 8 of 11

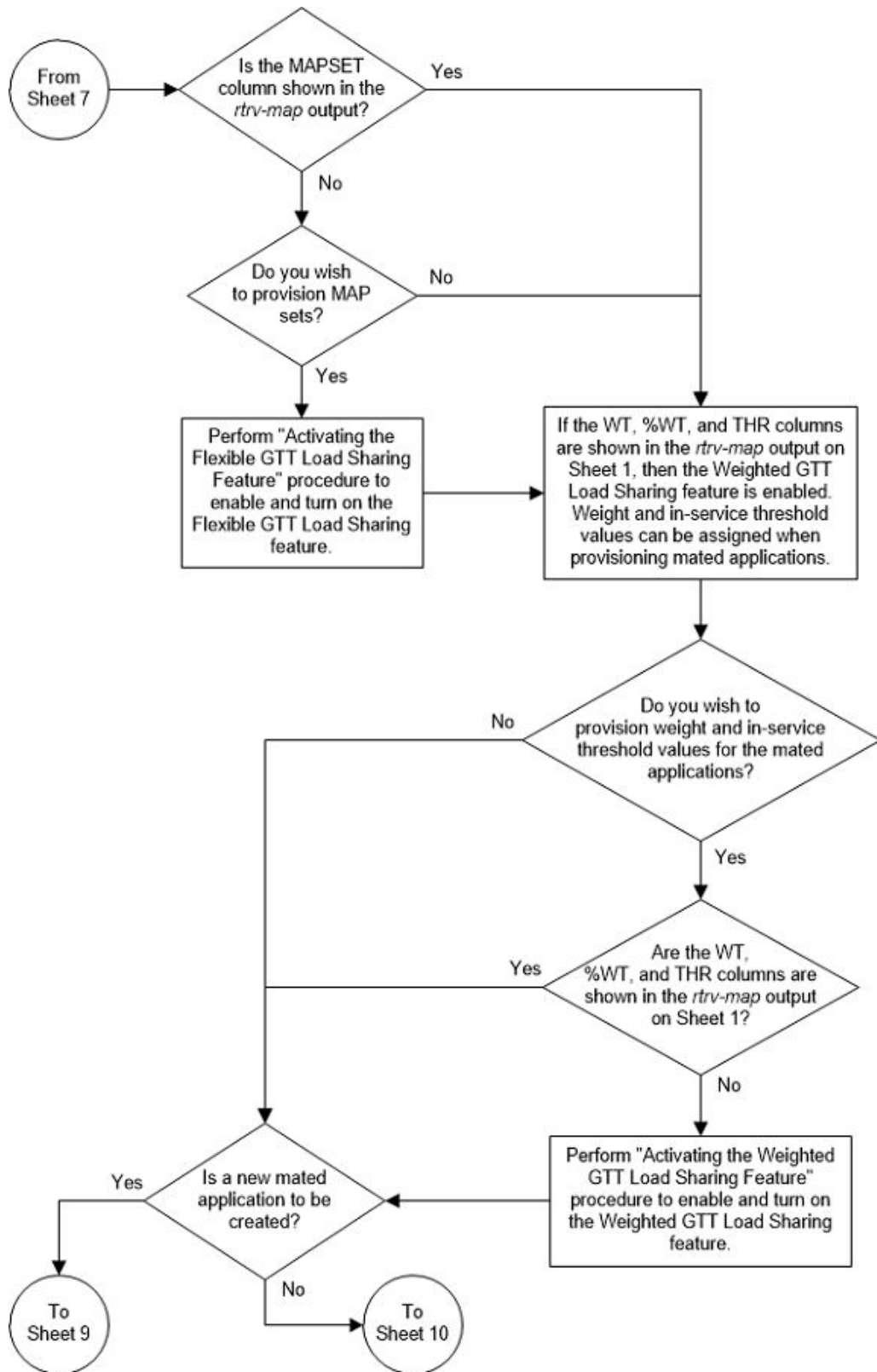

Figure 2-99 Provision a Combined Dominant/Load Shared Mated Application - Sheet 9 of 11

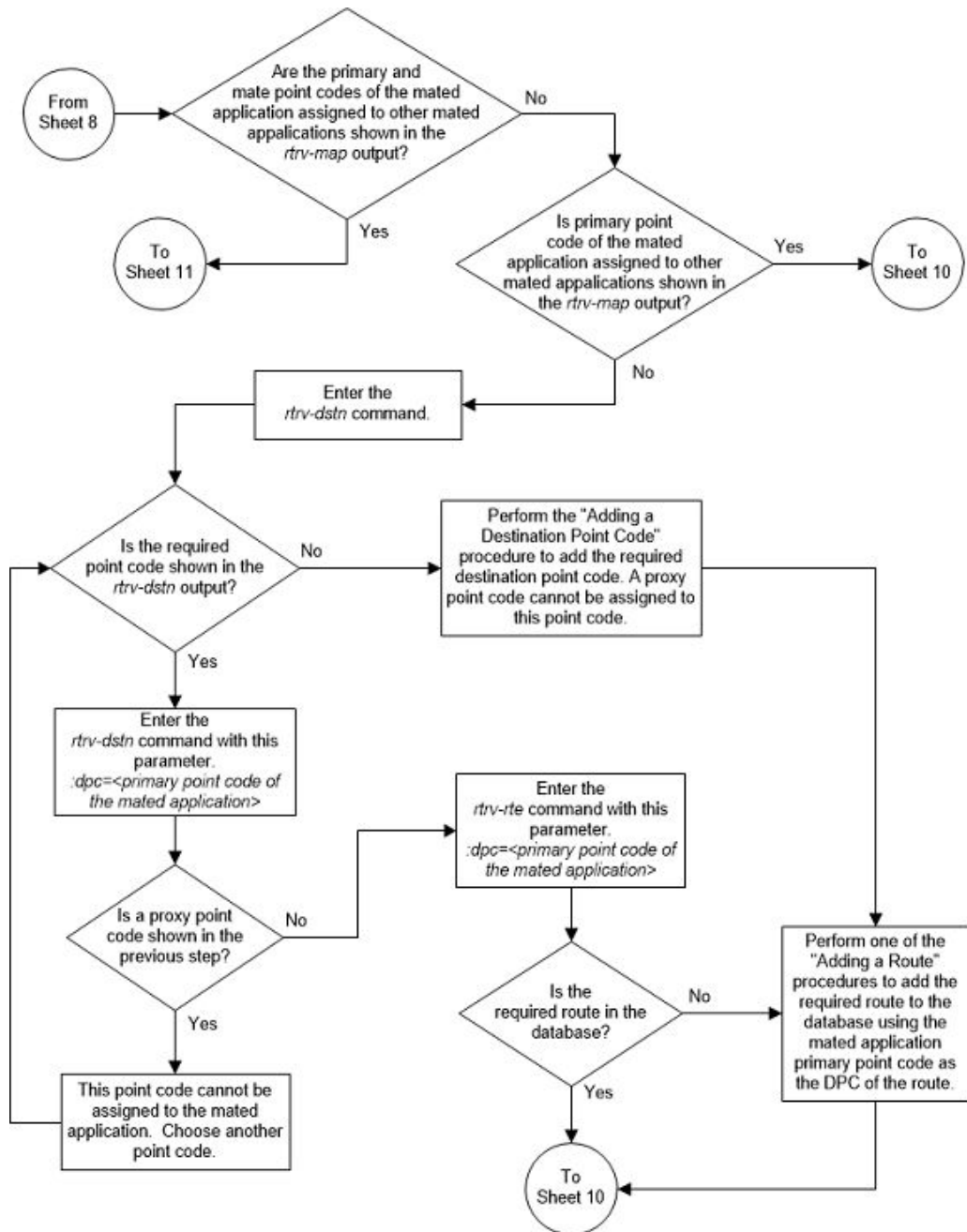

Figure 2-100 Provision a Combined Dominant/Load Shared Mated Application - Sheet 10 of 11

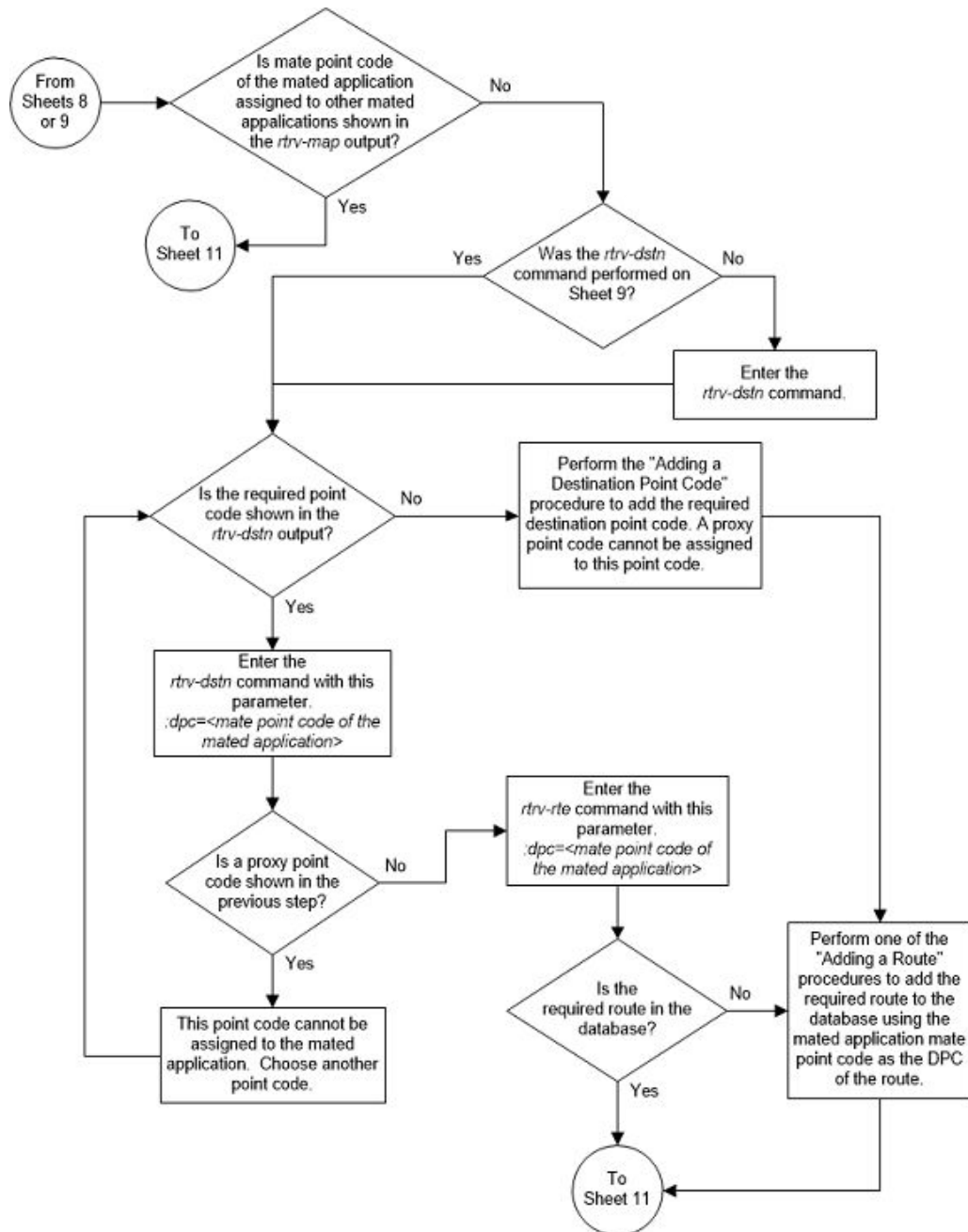
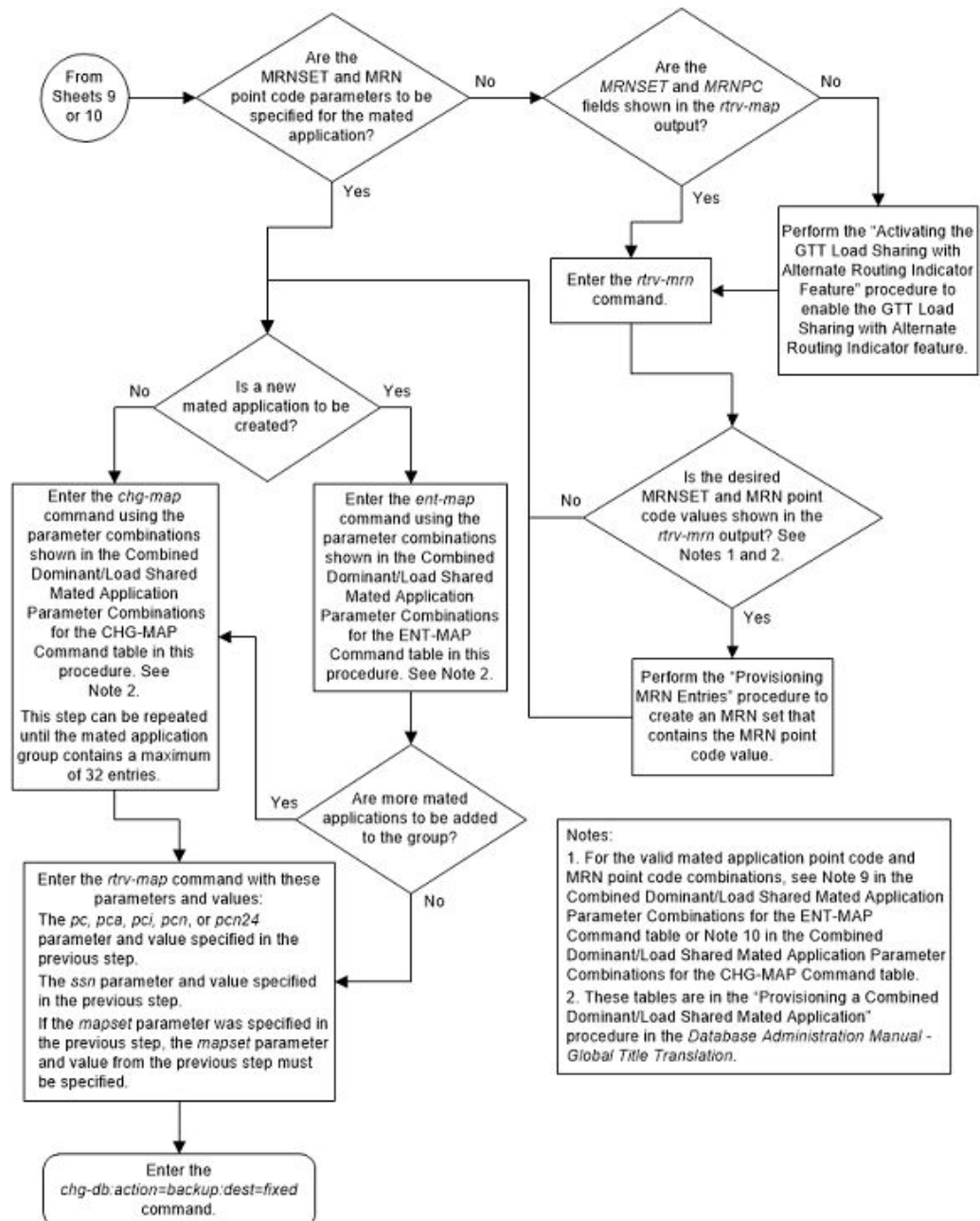

Figure 2-101 Provision a Combined Dominant/Load Shared Mated Application - Sheet 11 of 11



Removing a Mated Application

This procedure is used to remove a mated application from the database using the `dlt-map` command.

The `dlt-map` command uses these parameters.

`:pc/pca/pci/pcn/pcn24` – The point code (primary or mate point code) in the mated application group.

 **Note:**

Refer to Chapter 2, Configuring Destination Tables, in *Database Administration - SS7 User's Guide* for a definition of the point code types that are used on the EAGLE and for a definition of the different formats that can be used for ITU national point codes.

:*ssn* – Subsystem number – the subsystem number of the point code being removed.

:*all* – Removes all subsystems assigned to the point code being removed. If this parameter is not specified, only the specified subsystem number is removed.

:*mapset* – The MAP set ID that the mated application is assigned to, shown in the *rtrv-map* output. MAP set IDs are shown only if the Flexible GTT Load Sharing feature is enabled. If the Flexible GTT Load Sharing feature is enabled, the *mapset* parameter must be specified with the *dlt-map* command.

:*mrnset* – The MRN set ID assigned to the MAP set. This is the MRN set from which alternate routing indicator searches are performed. The *mrnset* parameter is shown in the *rtrv-map* output only if the GTT Load Sharing with Alternate Routing Indicator feature is enabled.

If an entire MAP set is being removed in this procedure (with the *all=yes* parameter), the reference to the MAP set specified in this procedure must be removed from any GTT, GTA, GSM OPCODE, GSM MAP screening, or MRN entries before an entire MAP set can be removed.

Perform one of these procedures to remove the reference to the MAP set.

- If the EGTT feature is not on – Enter the *rtrv-gtt* command to verify the MAP set ID references in the GTT entries. Perform [Changing a Global Title Translation](#) to remove the references to the MAP set.
- If the EGTT feature is on – Enter the *rtrv-gta* command to verify the MAP set ID references in the GTA entries. Perform [Changing Global Title Address Information](#) to remove the references to the MAP set.
- Enter the *rtrv-gsms-opcode* command to verify the MAP set ID references in the GSMOPCODE entries. Perform the “Changing a GSM MAP Screening Operation Code” procedure in *Database Administration - Features User's Guide* to remove the references to the MAP set.
- Enter the *rtrv-gsmmap-scrn* command to verify the MAP set ID references in the GSM MAP screening entries. Perform the “Changing a GSM MAP Screening Entry” procedure in *Database Administration - Features User's Guide* to remove the references to the MAP set.
- Enter the *rtrv-ppsopts* command to verify that the mated application's point code (if the Flexible GTT Load Sharing feature is not enabled) or the point code and MAP set ID (if the Flexible GTT Load Sharing feature is enabled) is not shown in the *rtrv-ppsopts* output. Any references to the mated application's point code or the point code and MAP set ID in the *rtrv-ppsopts* output are removed in [15](#).
- An entire MAP set cannot be removed if the MAP set is assigned to an MRN set. A specific point code/SSN in a MAP set cannot be removed if the MRN set that is assigned to the MAP set contains the point code that is being removed from the

MAP set. Verify that the MAP set is not assigned to any MRN sets by entering the `rtrv-mrn` command.

The last entry of a MAP set, other than the default MAP set, whose MAP set ID is referenced by a GTA entry in the GTT table cannot be removed if the `xlat` and `ri` parameter values for that GTA entry are `dpcssn` and `ssn`. Perform [Changing Global Title Address Information](#) to remove the references to the MAP set.

 **Note:**

If weight and threshold values are assigned to a load shared or combined dominant/load shared mated application, and if by removing entries from this mated application the mated application becomes either a solitary or dominant mated application, all weight and threshold values are removed from the remaining entries in the mated application.

If the `mapset=dflt` and `all=yes` parameters are specified with the `dlt-map` command, only the MAP group containing the point code value specified in the `dlt-map` command is removed from the default MAP set.

The mated application must be in the database.

Either the `ssn` or `all` parameters can be specified with the `dlt-map` command, but not both.

If the `ssn` parameter is specified, the point code and subsystem pair must exist in the mate application entity set. The point code and subsystem entry is then removed.

The value of the `ssn` parameter must be from 2 to 255.

Removing all point codes but one from a dominant, load shared, or combined dominant/load shared mated application group creates a solitary mated application.

If the primary point code is removed from a dominant mated application group containing more than one mate point code, the mate point code with the lowest relative cost value becomes the new primary point code.

If the primary point code is removed from a load shared mated application group containing more than one mate point code, the next mate point code in the group becomes the new primary point code.

If the primary point code is removed from a combined dominant/load shared mated application group containing more than one mate point code, which mate point code, and the resulting mated application group depends on the resulting relative cost values remaining in the group.

- If the mated application group contains mate point codes with the same relative cost value as the primary point code being removed, the next point code in the group with the same relative cost value as the primary point code becomes the new primary point code, and the mated application group remains a combined dominant/load shared mated application group.
- If the relative cost values of the mate point codes in the group are different from the relative cost value as the primary point code being removed, the next point code in the group with the lowest relative cost value becomes the new primary point code, and the mated application group becomes a load shared mated application group.

- If all the mate point codes in the resulting mated application group have the same relative cost values, the first point code in the resulting group becomes the new primary point code, and the mated application group becomes a load shared mated application group.
- If the primary point code is removed, and the resulting mated application group contains one point code with one relative cost value and a point code with another relative cost value, a dominant mated application group is created. The mate point code with the lowest relative cost value becomes the new primary point code.

Mated applications that contain the EAGLE's true point code and the subsystem number of one of the subsystems shown in [Table 2-51](#) cannot be removed from the database unless the subsystem has been removed from the database. The EAGLE's true point code is shown in the PCA, PCI, PCN, or PCN24 fields of the `rtrv-sid` output. The subsystem number is shown in the SSN field of the `rtrv-ss-appl` output.

Table 2-51 Subsystem Features

Feature	Subsystem	Feature Status	User's Guide that Contains the Procedures to Remove the Subsystem
LNP	LNP	Enabled	ELAP Administration and LNP Feature Activation
INP ANSI-41 INP Query	INP	Enabled and Turned On	INP/AINPQ
EIR	EIR	Enabled and Turned On	EIR
V-Flex	V-Flex	Enabled and Turned On	V-Flex
ATINP	ATINPQ	Enabled	ATINP
ANSI41 AIQ	AIQ	Enabled	Analyzed Information Features

Canceling the `RTRV-MAP` Command

Because the `rtrv-map` command used in this procedure can output information for a long period of time, the `rtrv-map` command can be canceled and the output to the terminal stopped. There are three ways that the `rtrv-map` command can be canceled.

- Press the F9 function key on the keyboard at the terminal where the `rtrv-map` command was entered.
- Enter the `canc-cmd` without the `trm` parameter at the terminal where the `rtrv-map` command was entered.
- Enter the `canc-cmd:trm=<xx>`, where `<xx>` is the terminal where the `rtrv-map` command was entered, from another terminal other than the terminal where the `rtrv-map` command was entered. To enter the `canc-cmd:trm=<xx>` command, the terminal must allow Security Administration commands to be entered from it and the user must be allowed to enter Security Administration commands. The terminal's permissions can be verified with the `rtrv-secu-trm`

command. The user's permissions can be verified with the `rtrv-user` or `rtrv-secu-user` commands.

For more information about the `canc-cmd` command, refer to *Commands User's Guide*.

1. Display the mated applications in the database using the `rtrv-map` command.

```
rlghncxa03w 09-07-07 00:34:31 GMT EAGLE5 41.1.0
```

```
MAPSET ID=DFLT   MRNSET ID=1       MRNPC =    001-001-003
PCA              Mate PCA       SSN RC MULT SRM MRC GRP NAME SSO WT
%WT THR
002-002-002                250 10  SHR *Y *Y  grp15   ON  10
16  20
                100-130-079   250 10  SHR *Y *Y  grp15   ON  20
33  20
                068-135-094   251 10  SHR *Y *Y  grp05   OFF 30
50  20
```

```
MAPSET ID=DFLT   MRNSET ID=----  MRNPC=-----
PCA              Mate PCA       SSN RC MULT SRM MRC GRP NAME SSO WT
%WT THR
005-005-005                250 10  DOM YES YES  grp15   OFF --
---  --
                060-060-060   250 20  DOM YES YES  grp15   OFF --
---  --
                070-070-070   251 30  DOM YES YES  grp05   ON  --
---  --
```

```
MAPSET ID=DFLT   MRNSET ID=----  MRNPC=-----
PCA              Mate PCA       SSN RC MULT SRM MRC GRP NAME SSO WT
%WT THR
007-007-007                251 10  SOL *Y *Y  grp05   ON  --
---  --
```

```
MAPSET ID=DFLT   MRNSET ID=----  MRNPC=-----
PCA              Mate PCA       SSN RC MULT SRM MRC GRP NAME SSO WT
%WT THR
255-001-000                250 10  SOL *Y *Y  grp01   ON  --
---  --
```

```
MAPSET ID=DFLT   MRNSET ID=----  MRNPC=-----
PCA              Mate PCA       SSN RC MULT SRM MRC GRP NAME SSO WT
%WT THR
255-001-000                253 10  SHR *Y *Y  grp01   OFF 20
66  20
                253-001-004   254 10  SHR *Y *Y  grp01   OFF 10
33  20
```

```
MAPSET ID=DFLT   MRNSET ID=----  MRNPC=-----
PCA              Mate PCA       SSN RC MULT SRM MRC GRP NAME SSO WT
%WT THR
255-001-002                251 10  SHR *Y *Y  grp01   OFF 10
50  20
                255-001-002   254 10  SHR *Y *Y  grp01   OFF 10
```

50 20

```

MAPSET ID=10      MRNSET ID=----- MRNPC=-----
PCA              Mate PCA      SSN RC MULT SRM MRC GRP NAME SSO WT
%WT THR
003-003-003      254 10  DOM YES YES grp10  ON  --
---  --
040-040-040      254 20  DOM YES YES grp10  ON  --
---  --
  
```

```

MAPSET ID=11      MRNSET ID=----- MRNPC=-----
PCA              Mate PCA      SSN RC MULT SRM MRC GRP NAME SSO WT
%WT THR
004-004-004      254 10  SHR *Y  *Y  grp10  OFF 10
50 20
100-100-100      254 10  SHR *Y  *Y  grp10  OFF 10
50 20
  
```

```

MAPSET ID=9       MRNSET ID=----- MRNPC=-----
PCA              Mate PCA      SSN RC MULT SRM MRC GRP NAME SSO WT
%WT THR
006-006-006      250 10  SOL *Y  *Y  grp15  OFF  --
---  --
  
```

```

MAPSET ID=12      MRNSET ID=----- MRNPC=-----
PCA              Mate PCA      SSN RC MULT SRM MRC GRP NAME SSO WT
%WT THR
008-008-008      254 10  COM YES *Y  grp10  ON  50
41 20
200-147-100      254 10  COM YES *Y  grp10  ON  40
33 20
179-183-050      250 10  COM YES *Y  grp15  OFF 30
25 20
031-049-100      250 20  COM YES *Y  grp15  ON  20
66 20
056-113-200      251 20  COM YES *Y  grp05  OFF 10
33 20
  
```

```

MAPSET ID=1       MRNSET ID=----- MRNPC=-----
PCA              Mate PCA      SSN RC MULT SRM MRC GRP NAME SSO WT
%WT THR
255-001-000      251 10  SHR *Y  *Y  grp01  OFF 10
33 20
253-001-002      254 10  SHR *Y  *Y  grp01  OFF 20
66 20
  
```

```

MAPSET ID=2       MRNSET ID=----- MRNPC=-----
PCA              Mate PCA      SSN RC MULT SRM MRC GRP NAME SSO WT
%WT THR
255-001-000      252 10  SOL *Y  *Y  grp01  ON  --
---  --
  
```

```

MAPSET ID=3       MRNSET ID=----- MRNPC=-----
PCA              Mate PCA      SSN RC MULT SRM MRC GRP NAME SSO WT
%WT THR
  
```

```

255-001-001          255 10  DOM YES YES grp01   ON  --
---  --
          253-001-005  254 20  DOM YES YES grp01   ON  --
---  --

MAPSET ID=4      MRNSET ID=DFLT  MRNPC=005-005-005
PCA             Mate PCA      SSN RC MULT SRM MRC GRP NAME SSO WT
%WT THR
255-001-001          250 10  DOM YES YES grp01   OFF --
---  --
          253-001-001  254 20  DOM YES YES grp01   OFF --
---  --

MAPSET ID=5      MRNSET ID=----  MRNPC=-----
PCA             Mate PCA      SSN RC MULT SRM MRC GRP NAME SSO WT
%WT THR
255-001-002          252 10  DOM YES YES grp01   ON  --
---  --
          255-001-003  254 20  DOM YES YES grp01   ON  --
---  --

MAPSET ID=6      MRNSET ID=1      MRNPC=005-005-005
PCA             Mate PCA      SSN RC MULT SRM MRC GRP NAME SSO WT
%WT THR
255-001-002          253 10  SHR *Y *Y  grp01   ON  10
50  20
          255-001-004  254 10  SHR *Y *Y  grp01   ON  10
50  20

MAPSET ID=7      MRNSET ID=----  MRNPC=-----
PCI             Mate PCI      SSN RC MULT SRM MRC GRP NAME SSO WT
%WT THR
2-001-2              255 10  DOM NO  NO  grp03   OFF --
---  --
          2-001-1      254 20  DOM NO  NO  grp03   OFF --
---  --

MAPSET ID=8      MRNSET ID=----  MRNPC=-----
PCN             Mate PCN      SSN RC MULT SRM MRC GRP NAME SSO WT
%WT THR
00347              253 10  SHR *N *N  grp05   OFF 10
50  20
          01387        254 10  SHR *N *N  grp05   OFF 10
50  20

MAP TABLE IS (37 of 36000) 1 % FULL

```

 **Note:**

If the Weighted GTT Load Sharing feature is not enabled and turned on, the WT, %WT, THR columns and values are not shown in the `rtrv-map` output.

2. Display the EAGLE's true point code by entering the `rtrv-sid` command. This is an example of the possible output.

```
rlghncxa03w 07-02-10 11:43:04 GMT EAGLE5 37.0.0
```

PCA	PCI	PCN	CLLI	PCTYPE
010-020-030	1-023-1	12-0-14-1	rlghncxa03w	OTHER
	s-1-023-1	s-12-0-14-1		

CPCA			
002-002-002	002-002-003	002-002-004	002-002-005
002-002-006	002-002-007	002-002-008	002-002-009
004-002-001	004-003-003	050-060-070	

CPCI			
1-001-1	1-001-2	1-001-3	1-001-4
1-002-1	1-002-2	1-002-3	1-002-4
2-001-1	7-222-7		

CPCN			
2-0-10-3	2-0-11-0	2-0-11-2	2-0-12-1
2-2-3-3	2-2-4-0	10-14-10-1	

Continue the procedure by performing one of these steps.

- If the mated application that is being removed contains a point code that is shown in the PCA, PCI, PCN, or PCN24 columns of the `rtrv-sid` output, continue the procedure with [3](#).
- If the mated application that is being removed does not contain a point code that is shown in the PCA, PCI, PCN, or PCN24 columns of the `rtrv-sid` output, continue the procedure by performing one of these steps.
 - If the MAPSET column is not shown in the `rtrv-map` output, then the Flexible GTT Load Sharing feature is not enabled. Continue the procedure with [16](#).
 - If only the MAPSET column is shown in the `rtrv-map` output, and a point code/SSN entry is being removed from the default MAP set, continue the procedure with [16](#).
 - If only the MAPSET column is shown in the `rtrv-map` output, and entries are being removed from MAP sets other than the default MAP set, continue the procedure with [7](#).
 - If the MAPSET and MRNSET columns are shown in the `rtrv-map` output, continue the procedure by performing one of these steps.
 - * If an entire MAP set is being removed, continue the procedure with [6](#).
 - * If a point code/SSN entry is being removed from the MAP set, continue the procedure with [7](#).
 - * If the MRN set entry is being removed from the MAP set, continue the procedure with [5](#).

 **Note:**

If the MRNSET column contains dashes, then an MRN set is not assigned to the MAP set.

3. Verify whether or not the any of the features shown in [Table 2-51](#) are enabled, and turned on if required, by entering the `rtrv-ctrl-feat` command.

This list shows the entries that are displayed in the `rtrv-ctrl-feat` output for the features that are enabled, and turned on if required.

- LNP TNs with a quantity greater than zero - the LNP feature is enabled.
- EIR with the status `on` - the EIR feature is enabled and turned on.
- VFLEX with the status `on` - the V-Flex feature is enabled and turned on.
- ATINP - the ATINP feature is enabled.
- INP with the status `on` - the INP feature is enabled and turned on.
- ANSI-41 INP Query with the status `on` - the ANSI-41 INP Query feature is enabled and turned on.
- ANSI41 AIQ - the ANSI41 AIQ feature is enabled.

 **Note:**

The `rtrv-ctrl-feat` command output contains other fields that are not used by this procedure. If you wish to see all the fields displayed by the `rtrv-ctrl-feat` command, refer to the `rtrv-ctrl-feat` command description in *Commands User's Guide*.

Continue the procedure by performing one of these steps.

- If none of the features shown in [Table 2-51](#) are enabled, and turned on if required, continue the procedure with [7](#).
 - If any of the features shown in [Table 2-51](#) are enabled, and turned on if required, continue the procedure with [4](#).
4. Verify the subsystem number of the mated application is in the subsystem application table by entering the `rtrv-ss-appl` command.

This is an example of the possible output.

```
rlghncxa03w 08-09-28 14:42:38 GMT EAGLE5 39.2.0
APPL      SSN      STAT
LNP      254      ONLINE
SS-APPL table is 20% FULL (1 of 5)
```

If a subsystem number is not shown in the `rtrv-ss-appl` output, continue the procedure with [7](#).

If the LNP feature is enabled and the LNP subsystem number is shown in the `rtrv-ss-appl` output, perform the procedures in *ELAP Administration and*

LNP Feature Activation Guide and remove the LNP subsystem number from the subsystem application table.

If the INP or ANSI-41 INP Query feature is enabled and turned on, and the INP subsystem number is shown in the `rtrv-ss-appl` output, perform the procedures in *INP/AINPQ User's Guide* and remove the INP subsystem number from the subsystem application table.

If the EIR feature is enabled and turned on and the EIR subsystem number is shown in the `rtrv-ss-appl` output, perform the procedures in *EIR User's Guide* and remove the EIR subsystem number from the subsystem application table.

If the V-Flex feature is enabled and turned on and the V-Flex subsystem number is shown in the `rtrv-ss-appl` output, perform the procedures in *V-Flex User's Guide* and remove the V-Flex subsystem number from the subsystem application table.

If the ATINP feature is enabled and the ATINPQ subsystem number is shown in the `rtrv-ss-appl` output, perform the procedures in *ATINP User's Guide* and remove the ATINP subsystem number from the subsystem application table.

If the ANSI41 AIQ feature is enabled and the AIQ subsystem number is shown in the `rtrv-ss-appl` output, perform the procedures in *Analyzed Information Features User's Guide*.

After the subsystem number has been removed from the subsystem application table, continue the procedure with 7.

5. Remove the MRN set from the MAP set using the `dlt-map` command with the `mapset`, `mrnset`, `pc/pca/pci/pcn/pcn24`, and `ssn` parameters and values shown in 1. For this example, enter this command.

```
dlt-map:mapset=6:mrnset=1:pca=255-001-002:ssn=252
```

This message should appear.

```
rlghncxa03w 09-02-07 11:48:16 GMT EAGLE5 40.1.0
DLT-MAP: MASP A - COMPLTD
```

If you wish to remove any point code/SSN entries from the MAP set, continue the procedure with 7.

If you do not wish to remove any point code/SSN entries from the MRN set, continue the procedure with 17.

6. Display the MRNs by entering the `rtrv-mrn` command. This is an example of the possible output.

```
rlghncxa03w 09-02-07 00:34:31 GMT EAGLE5 40.1.0
```

MRNSET	MAPSET	MAPPC	MAPSSN	PC	RC	WT
%WT	THR					
DFLT	7	002-002-007	50	005-005-005	10	10
50	30			006-001-001	10	10
50	30			006-001-002	30	20
100	30			006-001-003	40	20

```

100 30
                                     006-001-004  50 20
100 30
      MRNSET MAPSET  MAPPC           MAPSSN    PC           RC WT
%WT THR
  1      5      255-001-002      252      005-005-005  10 10
4      1
                                     006-001-001  10 10
4      1
                                     006-001-002  10 30
12     1
                                     006-001-003  10 40
15     1
                                     006-001-005  10 40
15     1
                                     006-001-006  10 40
15     1
                                     006-001-007  10 40
15     1
                                     006-001-004  10 50
19     1
                                     006-001-008  20 20
25     1
                                     006-001-009  20 30
37     1
                                     006-001-010  20 30
37     1

```

MRN table is (16 of 5990) 1% full

 **Note:**

If the Weighted GTT Load Sharing feature is not enabled and turned on, the WT, %WT, THR columns and values are not shown in the `rtrv-mrn` output.

If the MAP set is not assigned to any MRN sets, continue the procedure with [7](#).

If the MAP set is assigned to any MRN sets, perform [Removing MRN Entries](#) to remove the MAP set from any MRN sets. After the MAP set has been removed from the MAP sets, continue the procedure with [7](#).

7. Verify whether or not the EGTT feature is on by entering the `rtrv-feat` command.

The entry `EGTT = on` is shown if the EGTT feature is on. If the EGTT feature is on, continue the procedure with [10](#). If the EGTT feature is not on, continue the procedure with [8](#).

 **Note:**

The `rtrv-feat` command output contains other fields that are not used by this procedure. If you wish to see all the fields displayed by the `rtrv-feat` command, refer to the `rtrv-feat` command description in *Commands User's Guide*.

8. Display the translation types in the database using the `rtrv-tt` command.

This is an example of the possible output.

```
rlghncxa03w 07-05-25 09:42:31 GMT EAGLE5 37.0.0
TYPEA      TTN      NDGT
1          lidb     5
2          c800    10
3          d700    6
5          scp1    6
10         scp2    6
15         scp3    3

ALIAS      TYPEA
30         5
40         10
50         3
65         3

TYPEI      TTN      NDGT
105       itudb   8

ALIAS      TYPEI
7         105

TYPEN      TTN      NDGT
120       dbitu   7

ALIAS      TYPEN
8         120
```

9. Display the global title translations in the database using the `rtrv-gtt` command specifying a translation type from the `rtrv-tt` command output shown in 8, and the MAP set ID that will be removed in 16.

For this example, enter this command.

```
rtrv-gtt:typea=10:mapset=6
```

This is an example of the possible output.

```
rlghncxa03w 08-10-25 09:43:31 GMT EAGLE5 39.2.0
TYPEA TTN      NDGT
10    scp2    6

GTT TABLE IS 10 % FULL (27000 of 269999)

START GTA          END GTA          XLAT  RI  PC
```

```

615370                615380                DPCSSN SSN
003-003-003
      MAPSET=6        SSN=254 NGT=----

```

Command Retrieved 1 Entries

If the `rtrv-gtt` output shows any entries, perform [Changing a Global Title Translation](#) to change the MAP set assignment for the global title translations displayed in this step.

Repeat 8 and 9 for the other translation types shown in 8.

When 8 and 9 have been performed for all the translation types shown in 8, continue the procedure with 12.

10. Display the GTT sets in the database using the `rtrv-gttset` command.

This is an example of the possible output.

```

rlghncxa03w 09-07-07 00:27:31 GMT EAGLE5 41.1.0
GTTSN      NETDOM  NDGT
lidb       ansi     10
t800       ansi     10
si000      itu      15
imsi       itu      15
abcd1234   itu      12

```

GTT-SET table is (5 of 2000) 1% full.

11. Display the global title address (GTA) information for a GTT set from 10.

Use the `rtrv-gta` command with the `gttsn` parameter value shown in the output of 10, and the MAP set ID that will be removed in 16. For this example, enter this command.

```
rtrv-gta:gttsn=t800:mapset=6
```

This is an example of the possible output.

```
rlghncxa03w 10-07-07 00:27:31 GMT EAGLE5 42.0.0
```

```

GTTSN      NETDOM  SETTYPE  NDGT
t800       ansi     CDGTA    10
GTA TABLE IS  1 % FULL (17 of 26999)

```

```

START GTA  END GTA   XLAT  RI    PC
3365840000 3365849999 dpc   ssn   001-255-001
      MAPSET=6      SSN=0    CCGT=no CGGTMOD=NO
      GTMODID=----- TESTMODE=off
      OPTSN=-----  CGSELID=----- OPCS=-----
      ACTSN=act10    PPMEASREQD= NO

```

Command Retrieved 1 Entries

If the `rtrv-gta` output shows any entries, perform [Changing Global Title Address Information](#) to change the MAP set assignment for the global title translations displayed in this step.

Repeat 10 and 11 for the other GTT set names shown in 10.

When 10 and 11 have been performed for all the GTT set names shown in 10, continue the procedure with 12.

12. Display the GSM MAP screening operation codes assigned to the **MAP** set that will be removed in this procedure using the `rtrv-gsms-opcode` command with the MAP set ID that will be removed in 16.

For this example, enter this command.

```
rtrv-gsms-opcode:mapset=6
```

This is an example of the possible output.

```
rlghncxa03w 08-10-10 11:43:04 GMT EAGLE5 39.2.0
```

OPCODE	OPNAME	DFLTACT	PCA	SSN	MAPSET	RI	TT
36	for1	fwd	002-002-002	10	6	ssn	-
OPCODE	OPNAME	DFLTACT	PCI	SSN	MAPSET	RI	TT
OPCODE	OPNAME	DFLTACT	PCN	SSN	MAPSET	RI	TT
OPCODE	OPNAME	DFLTACT	PCN24	SSN	MAPSET	RI	TT
OPCODE	OPNAME	DFLTACT					

```
GSMMS OPCODE Table (10 of 257) is 4% full
```

If the `rtrv-gsms-opcode` output shows any entries, perform the “Changing a GSM MAP Screening Operation Code” procedure in *Database Administration - Features User's Guide* and change the MAP set assignment for the operation code entries displayed in this step.

13. GSM MAP screening entries cannot reference the MAP set being removed in this procedure.

The `opname` parameter value from the `rtrv-gsms-opcode` output must be used to display the GSM MAP screening entries. Display the GSM MAP screening operation codes in the database using the `rtrv-gsms-opcode` command without the `mapset` parameter. This is an example of the possible output.

```
rlghncxa03w 08-10-10 11:43:04 GMT EAGLE5 39.2.0
```

OPCODE	OPNAME	DFLTACT	PCA	SSN	MAPSET	RI	TT
36	for1	fwd	002-002-002	10	6	ssn	-
OPCODE	OPNAME	DFLTACT	PCI	SSN	MAPSET	RI	TT
93	dd93	dupdc	5-25-3	200	DFLT		
139	fwd139	fwd	3-159-7	128	3	gt	10
OPCODE	OPNAME	DFLTACT	PCN	SSN	MAPSET	RI	TT
187	dup187	dupl	11519	79	DFLT		
OPCODE	OPNAME	DFLTACT	PCN24	SSN	MAPSET	RI	TT

```

OPCODE  OPNAME      DFLTACT
  22     sri        disc
  25     route25    route
  50     pass50     pass
  71     ati        atierr
  150    discard1   disc
  *     star       pass

```

GSMMS OPCODE Table (10 of 257) is 4% full

14. Display the GSM MAP screening entries assigned to the MAP set being removed in this procedure.

Enter the `rtrv-gsmmap-scrn` command with an `opname` value shown in the `rtrv-gsms-opcode` command output in 13 and with the MAP set ID that will be removed in 16.

For this example, enter this command.

```
rtrv-gsmmap-scrn:opname=dd93:mapset=6
```

This is an example of the possible output.

```
rlghncxa03w 08-10-20 09:07:58 GMT EAGLE5 39.2.0
```

Single CgPA Entries for OPNAME=dd93

```

-----
SADDR          NP NAI FORBD ACT      PCA          SSN CGSR
MAPSET  RI
92546         * *  all  fwd      001-001-001  5  cg07
6            ssn
TT=-

```

```

SADDR          NP NAI FORBD ACT      PCI          SSN CGSR
MAPSET

```

```

SADDR          NP NAI FORBD ACT      PCN          SSN CGSR
MAPSET

```

```

SADDR          NP NAI FORBD ACT      PCN24        SSN CGSR
MAPSET

```

```
SADDR          NP NAI FORBD ACT  CGSR
```

Range CgPA Entries for OPNAME=dd93

```

-----
SADDR          EADDR          NP NAI FORBD ACT      PCA
SSN CGSR
3234567        3345678        * *  all  dupl      001-001-001
30  cg15
MAPSET=6 RI=ssn TT=-

```

```

SADDR          EADDR          NP NAI FORBD ACT      PCI
SSN CGSR

```

```

SADDR          EADDR          NP NAI FORBD ACT      PCN
SSN CGSR

SADDR          EADDR          NP NAI FORBD ACT      PCN24
SSN CGSR

SADDR          EADDR          NP NAI FORBD ACT      CGSR

```

GSM MAP Screening Table (9 of 4000) is 1% full

If the `rtrv-gsmmap-scrn` output shows any entries, perform the “Changing a GSM MAP Screening Entry” procedure in *Database Administration - Features User's Guide* and change the MAP set assignment for the GSM MAP screening entries displayed in this step.

Repeat 13 and 14 for the other GSM operation code entries shown in 13.

When 13 and 14 have been performed for all the GSM operation code entries shown in 13, continue the procedure with 15.

15. The mated application cannot be removed if the point code of the mated application (if the Flexible GTT Load Sharing feature is not enabled) or the point code and MAP set ID of the mated application (if the Flexible GTT Load Sharing feature is enabled) is shown in the `rtrv-ppsopts` command output. Enter the `rtrv-ppsopts` command to verify that the mated application's point code or point code and MAP set ID is not shown in the `rtrv-ppsopts` output. This is an example of the possible output.

```

rlghncxa03w 09-03-20 09:07:58 GMT  EAGLE5 40.1.0
Prepaid SMS Options
-----
BPARTYCHK      = OFF
PPT            PCA/PCI/PCN          SSN      RI      Set ID
---            -
1             PCI:    1-001-1          25      SSN     DFLT
2             -----          NONE     GT      DFLT
3             -----          NONE     GT      DFLT
4             PCI:    1-001-1          30      GT      1
5             -----          NONE     GT      DFLT
6             -----          NONE     GT      DFLT
7             -----          NONE     GT      DFLT
8             PCI:    1-001-1          75      SSN     1
9             -----          NONE     GT      DFLT
10            -----          NONE     GT      DFLT
11            -----          NONE     GT      DFLT
12            -----          NONE     GT      DFLT
13            -----          NONE     GT      DFLT
14            -----          NONE     GT      DFLT
15            -----          NONE     GT      DFLT
16            -----          NONE     GT      DFLT
17            -----          NONE     GT      DFLT
18            -----          NONE     GT      DFLT
19            -----          NONE     GT      DFLT
20            -----          NONE     GT      DFLT
21            -----          NONE     GT      DFLT
22            -----          NONE     GT      DFLT

```

If the `rtrv-ppsopts` output shows any entries that reference the mated application's point code (if the Flexible GTT Load Sharing feature is not enabled) or the mated application's point code and MAP set ID (if the Flexible GTT Load Sharing feature is enabled), remove the reference using the `chg-ppsopts` command with the prepaid portability type (the `PPT` value) that contains the reference and either the `pci=none` or `pcn=none` parameters (depending on the type of point code the prepaid portability type contains).

```
chg-ppsopts:ppt=4:pci=none
```

This is an example of the possible output.

```
rlghncxa03w 07-05-20 09:07:58 GMT EAGLE5 37.0.0
CHG-PPSOPTS: MASP A - COMPLTD
```

Repeat this step for other entries shown in the `rtrv-ppsopts` output that contain the mated application's point code or point code and MAP set ID.

16. Remove the mated application from the database using the `dlt-map` command with a point code and subsystem number from the `rtrv-map` command output shown in 1.

If the `MAPSET` field is shown in the `rtrv-map` output in 1, showing that the Flexible GTT Load Sharing feature is enabled, the `mapset` parameter must be specified with the `dlt-map` command.

If the Flexible GTT Load Sharing feature is not enabled, for this example, enter this command.

```
dlt-map:pca=255-001-002:ssn=253
```

This message should appear.

```
rlghncxa03w 07-05-07 11:48:16 GMT EAGLE5 37.0.0
DLT-MAP: MASP A - COMPLTD
```

If the Flexible GTT Load Sharing feature is enabled, for this example, enter this command.

```
dlt-map:pca=255-001-002:ssn=253:mapset=6
```

This message should appear.

```
rlghncxa03w 07-05-07 11:48:16 GMT EAGLE5 37.0.0
DLT-MAP: MASP A - COMPLTD
```

Note:

If all the subsystems for a specified point code (`pc`, `pca`, `pci`, or `pcn`) are being removed from the mated application table, enter the `dlt-map` command with the point code and the `all=yes` parameter. This results in removing the point code from the mated application table. For this example, enter the `dlt-map:pca=255-001-002:all=yes` command. If the Flexible GTT Load Sharing feature is enabled, enter the `dlt-map:pca=255-001-002:all=yes:mapset=6` command.

 **Note:**

Removing the last subsystem assigned to a point code removes the point code from the mated application table.

17. Verify the changes using the `rtrv-map` command with the point code and subsystem specified in 5 or 16.

If the `mapset` parameter was specified in 16, the `mapset` parameter should be specified with the `rtrv-map` command.

If the `mapset` parameter was not specified in 16, for this example, enter this command.

```
rtrv-map:pca=255-001-002:ssn=253
```

If the `mapset` parameter was specified in 16, for this example, enter this command.

```
rtrv-map:pca=255-001-002:ssn=253:mapset=6
```

The EAGLE responds with this message showing that the subsystem assigned to the point code is no longer in the database.

```
E2456 Cmd Rej: SSN does not exist for given remote point code
```

 **Note:**

If all the subsystems for a specified point code (`pc`, `pca`, `pci`, or `pcn`) were removed from the mated application table in 16 (either by specifying the `all=yes` parameter, or by removing the last subsystem assigned to the point code from the mated application table), resulting in removing the point code from the mated application table, enter the `rtrv-map` command with the point code specified in 16. For this example, enter the `rtrv-map:pca=255-001-002` command. If the `mapset` parameter was specified in 16, enter the `rtrv-map:pca=255-001-002:mapset=6` command.

The EAGLE responds with this message showing that the point code is no longer in the database.

```
E2452 Cmd Rej: Remote point code does not exist
```

If the MRN set was removed from the MAP set in 5, enter the `rtrv-map` command with the `mapset`, point code and `ssn` parameters and values specified in 5. For this example, enter this command.

```
rtrv-map:mapset=6
```

 **Note:**

If the `mapset=dflt` parameter was specified in 5, the `mapset=dflt`, point code, and `ssn` parameters specified in 5 must be specified with the `rtrv-map` command.

This is an example of the possible output.

```
rlghncxa03w 09-07-07 00:34:31 GMT EAGLE5 41.1.0

MAPSET ID=6      MRNSET ID=----- MRNPC=-----
PCA             Mate PCA      SSN RC MULT SRM MRC GRP NAME SSO WT
%WT THR
255-001-002          253 10  SHR *Y  *Y  grp01   ON  10
50  20
                255-001-004  254 10  SHR *Y  *Y  grp01   ON  10
50  20

MAP TABLE IS (37 of 36000) 1 % FULL
```

18. Backup the new changes using the `chg-db:action=backup:dest=fixed` command.

These messages should appear, the active Maintenance and Administration Subsystem Processor (MASP) appears first.

```
BACKUP (FIXED) : MASP A - Backup starts on active MASP.
BACKUP (FIXED) : MASP A - Backup on active MASP to fixed disk
complete.
BACKUP (FIXED) : MASP A - Backup starts on standby MASP.
BACKUP (FIXED) : MASP A - Backup on standby MASP to fixed disk
complete.
```

Figure 2-102 Remove a Mated Application - Sheet 1 of 5

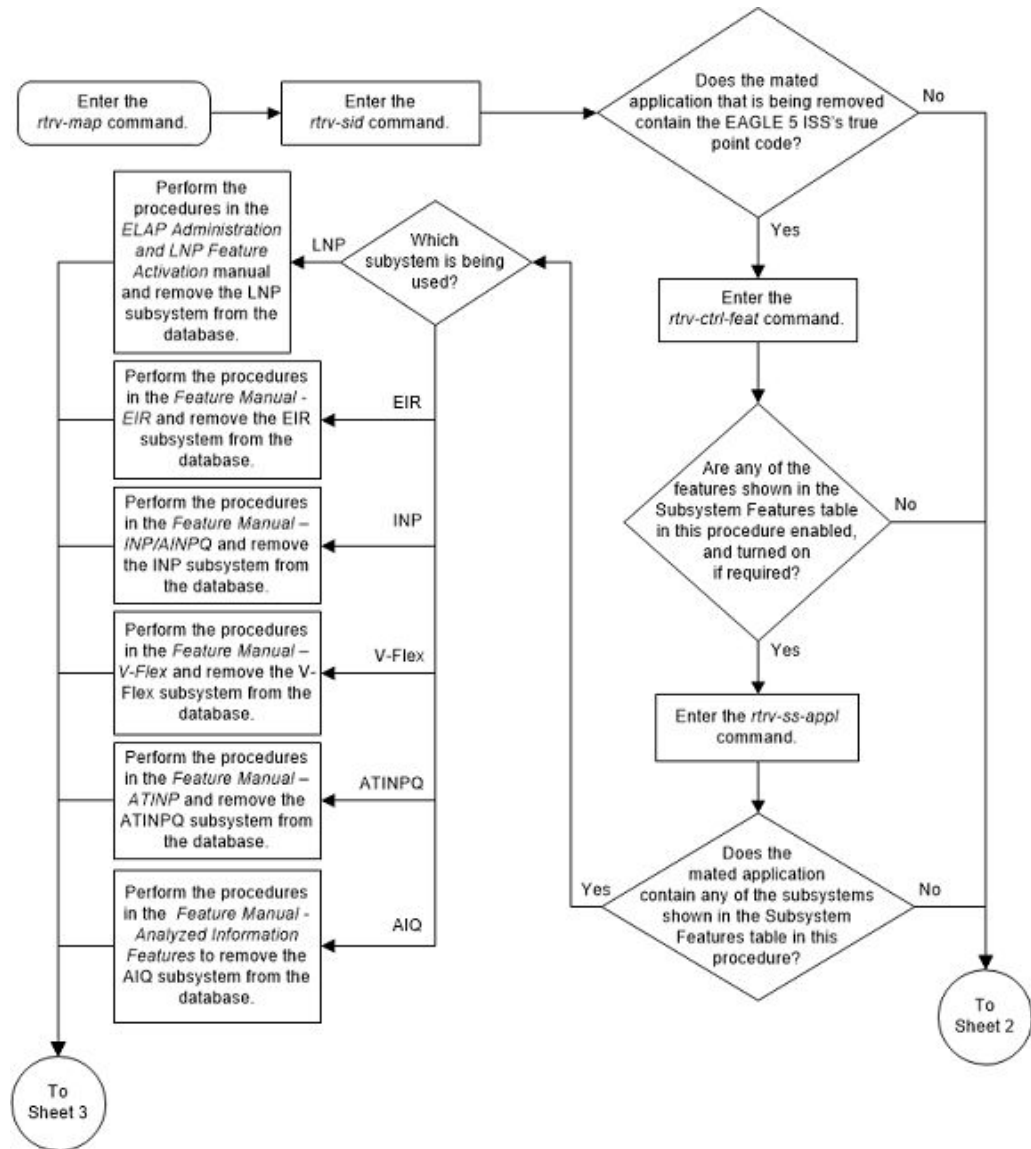

Figure 2-103 Remove a Mated Application - Sheet 2 of 5

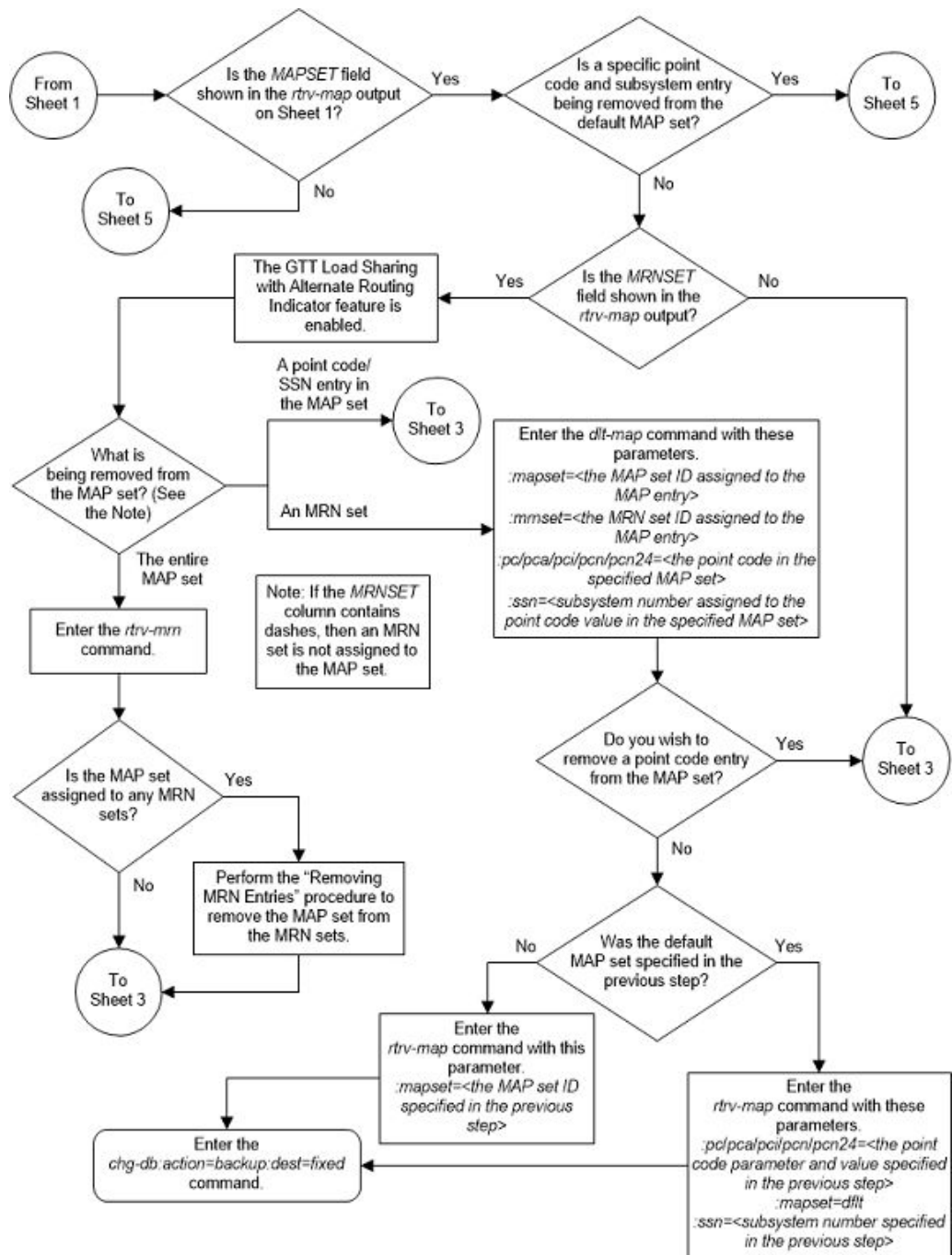

Figure 2-104 Remove a Mated Application - Sheet 3 of 5

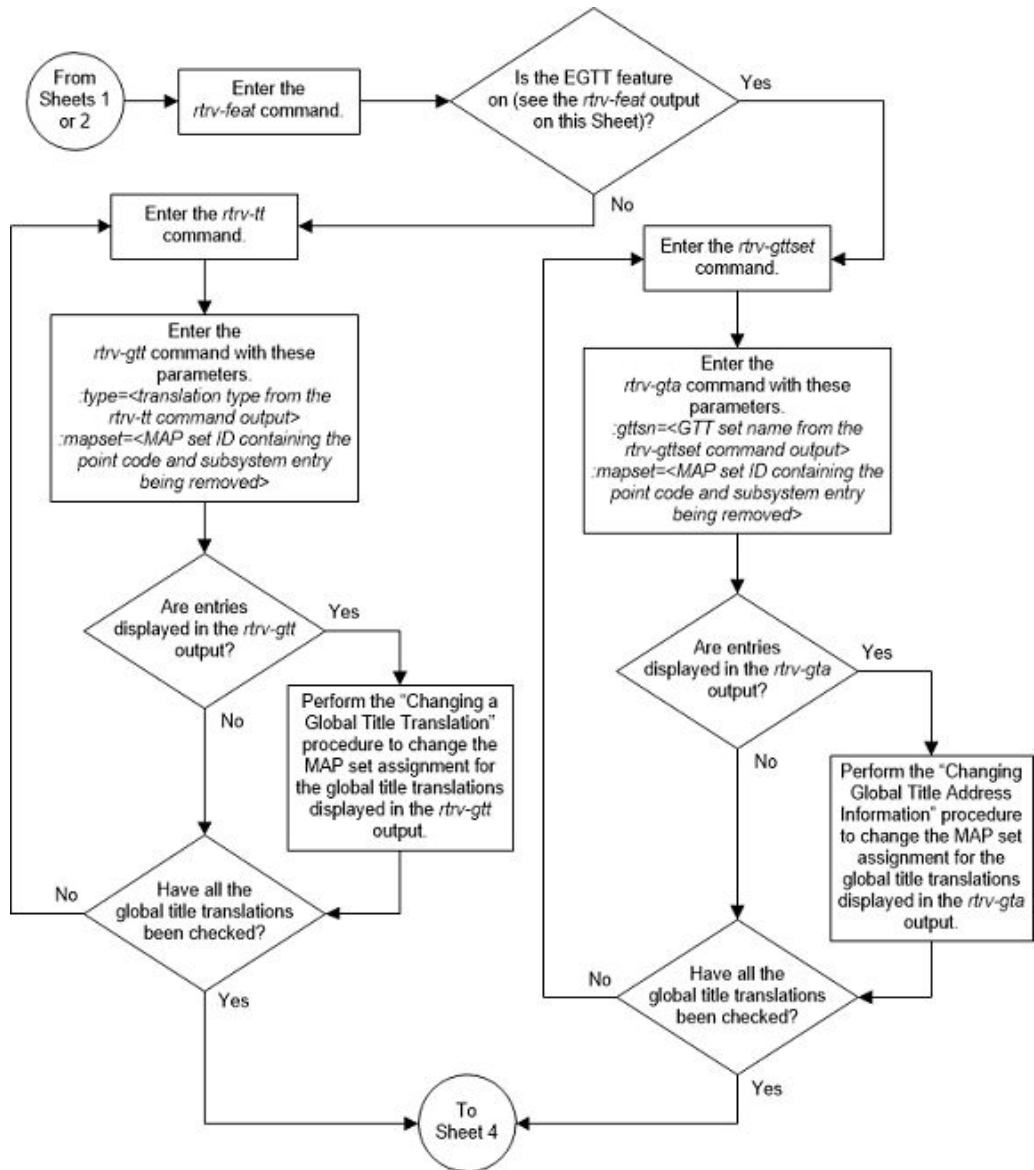

Figure 2-105 Remove a Mated Application - Sheet 4 of 5

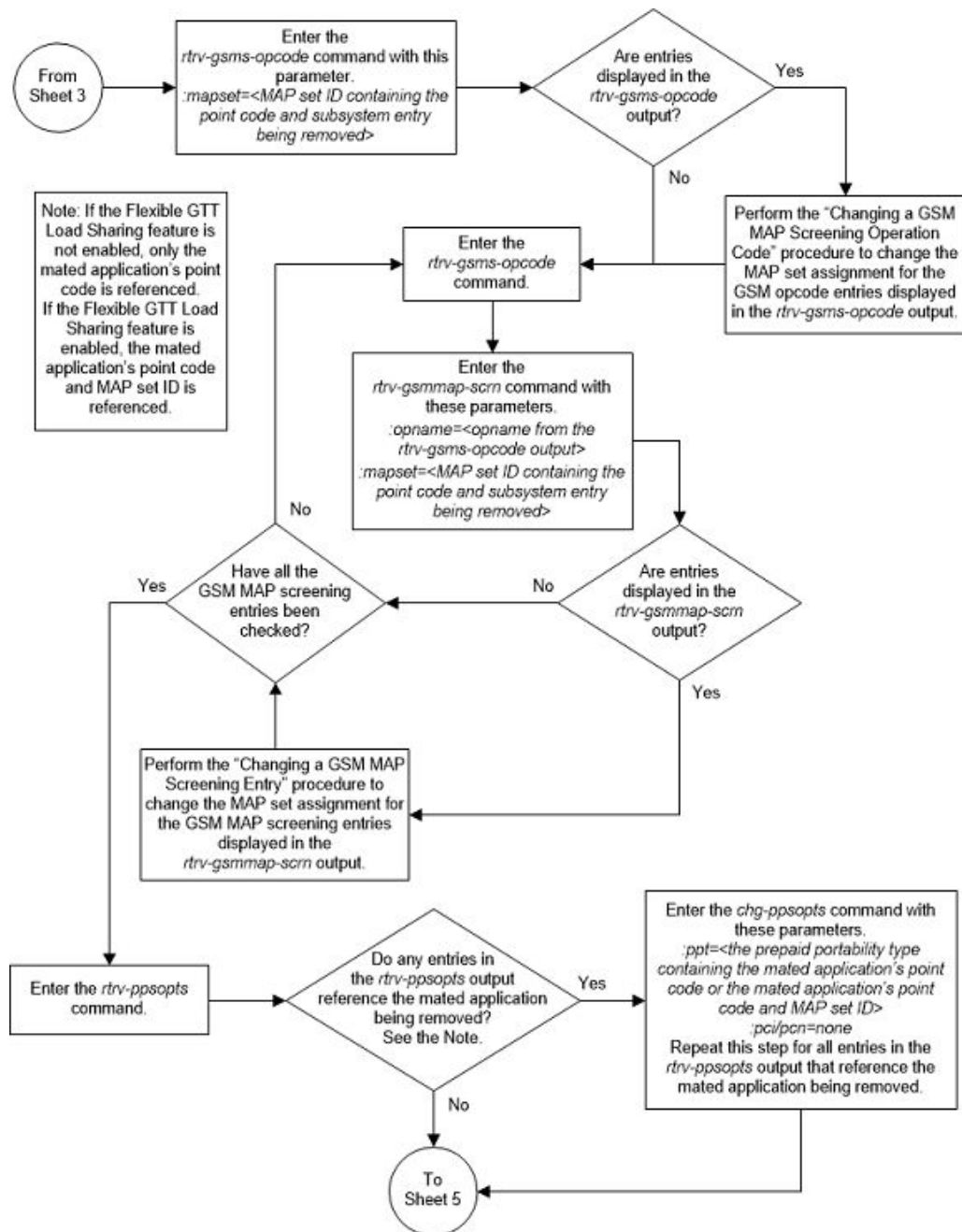
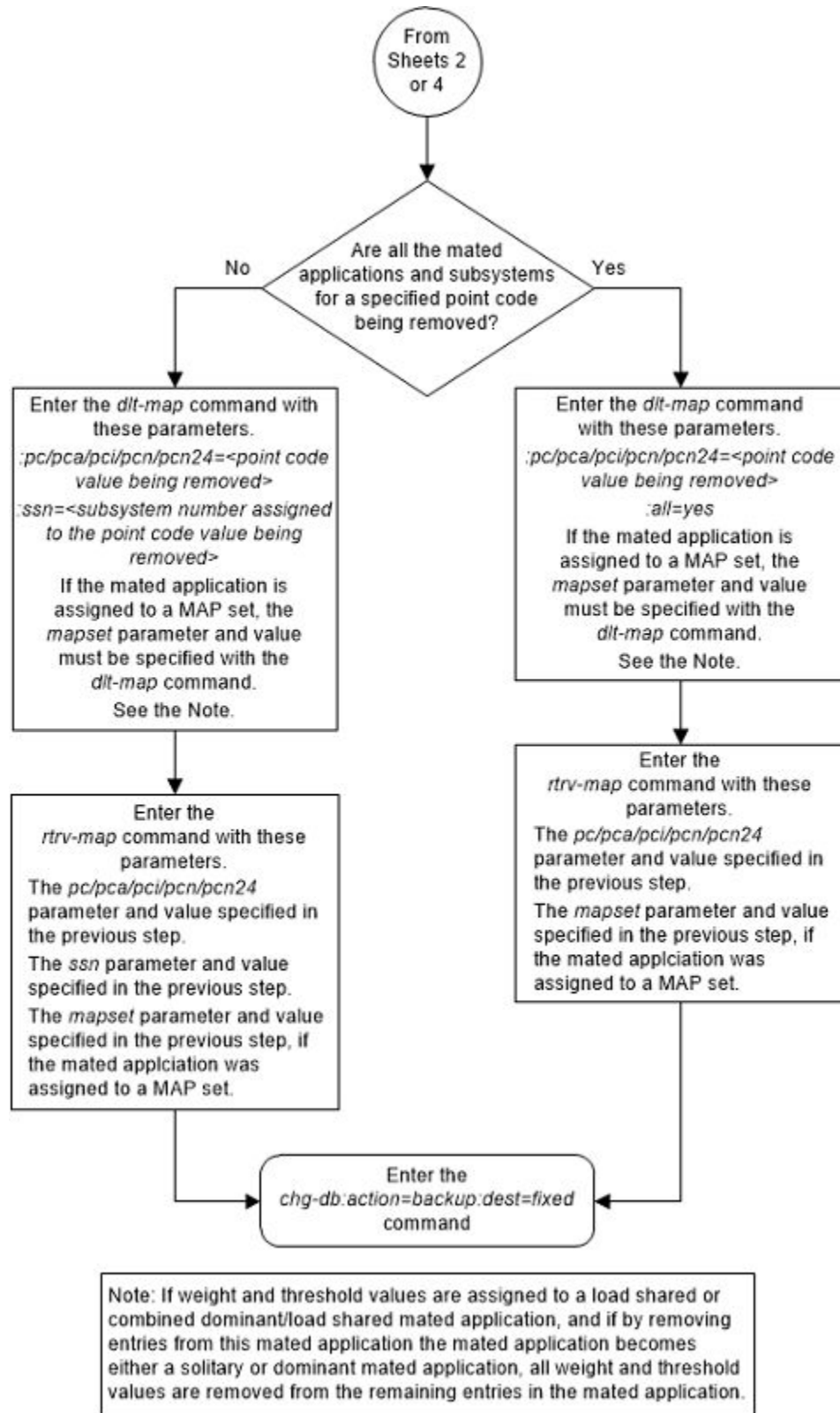

Figure 2-106 Remove a Mated Application - Sheet 5 of 5



Changing the Attributes of a Mated Application

This procedure is used to change the values of the parameters of the existing mated application (MAP) group or MAP set, shown in [Table 2-52](#), using the `chg-map` command.

Table 2-52 Mated Application Parameters

CSPC group name	sso	srm	mrc	rc
-----------------	-----	-----	-----	----

Changing the `rc` value of the mated application in this procedure is not performed to change the mated application type. If you wish to change the mated application type, perform the [Changing the Mated Application Type](#) procedure.

The `chg-map` command contains other parameters that are not used in this procedure. Perform these procedures as applicable to change the other parameter values.

- To change the weights or in-service thresholds of the mated application, perform the [Changing the Weight and In-Service Threshold Values of a Mated Application](#) procedure.
- To change the MRNSET and MRN point code values assigned to the mated application, perform the [Changing the MRNSET and MRN Point Code Values of MAP Entries](#) procedure.

The `chg-map` command can also be used to add point code/SSN entries to an existing MAP group or MAP set. This action is not covered in this procedure. If you wish to add point code/SSN entries to an existing MAP group or MAP set, perform one of these procedures.

- [Provisioning a Solitary Mated Application](#)
- [Provisioning a Dominant Mated Application](#)
- [Provisioning a Load Shared Mated Application](#)
- [Provisioning a Combined Dominant/Load Shared Mated Application](#)

The `chg-map` command in this procedure uses these parameters.

`:pc/pca/pci/pcn/pcn24` – The point code of the primary signaling point that is to receive the message.

 **Note:**

The point codes can be either an ANSI point code (`pc/pca`), ITU-I or ITU-I spare point code (`pci`), a 14-bit ITU-N or 14-bit ITU-N spare point code (`pcn`), or a 24-bit ITU-N (`pcn24`) point code.

 **Note:**

Refer to Chapter 2, Configuring Destination Tables, in *Database Administration - SS7 User's Guide* for a definition of the point code types that are used on the EAGLE and for a definition of the different formats that can be used for ITU national point codes.

:*ssn* – Subsystem number – the subsystem address of the primary point code that is to receive the message.

:*rc* – The relative cost value of the primary point code and subsystem, defined by the *pc/pca/pci/pcn/pcn24* and *ssn* parameters. The *rc* parameter has a range of values from 0 to 99.

:*grp* – The name of the concerned signaling point code group that contains the point codes that should be notified of the subsystem status. This parameter applies to both RPCs/SSNs.

:*mrc* – Message routing under congestion – specifies whether Class 0 messages are routed during congestion conditions. The values for this parameter are *yes* and *no*. This parameter can be specified for any type of mated application, but this parameter affects only the traffic for a dominant mated application.

:*srm* – Subsystem routing messages – defines whether subsystem routing messages (SBR, SNR) are transmitted between the mated applications. The values for this parameter are *yes* and *no*. The *srm=yes* parameter can be specified only for ANSI mated applications. This parameter affects traffic only on dominant and combined dominant/load shared mated applications.

:*sso* – Subsystem Status Option – defines whether the subsystem status option is on or off. This parameter allows the user the option to have the specified subsystem marked as prohibited even though an MTP-RESUME message has been received by the indicating that the specified point code is allowed. The *sso* parameter cannot be specified if the *pc/pca/pci/pcn/pcn24* value is the EAGLE's true point code, shown in the *rtrv-sid* output.

:*mapset* – The MAP set ID that the mated applications are assigned to, shown in the *rtrv-map* output. MAP set IDs are shown only if the Flexible GTT Load Sharing feature is enabled. The *mapset* parameter value cannot be changed in this procedure. If the *rtrv-map* output shows the *MAPSET* field, the *mapset* parameter must be specified with the *chg-map* command. If the *rtrv-map* output does not show the *MAPSET* field, the Flexible GTT Load Sharing feature is not enabled. The *mapset* parameter cannot be specified with the *chg-map* command. The *mapset* parameter has two values.

- *dflt* – to change the mated application in the default MAP set. The EAGLE's true point code (shown in the *rtrv-sid* output) and subsystem can be assigned only to the default MAP set.
- the specific number of an existing MAP set if you are changing the mated application in an existing MAP set.

:*force=yes* – This parameter must be specified if the *rc* parameter is specified with either the *srm* or *mrc* parameters.

At least one optional parameter must be specified.

The mated application to be changed must be in the database.

If the primary point code and subsystem are being changed, the current mated application must be removed from the database and a new mated application with the new primary point code and subsystem, containing the mated point codes and subsystems from the mated application that was removed, should be added to the database.

If the point code is entered with the `pc` or `pca` parameters, the specified point codes in the concerned point code broadcast group must have been entered with the `pc` or `pca` parameters of the `ent-cspc` command. If the point code is entered with the `pci,pcn`, or `pcn24` parameters, the specified point codes in the concerned point code broadcast group must have been entered with the `pci,pcn`, or `pcn24` parameters of the `ent-cspc` command, respectively.

If the mated application contains the EAGLE's true point code, the relative cost value assigned to this point code must be the lowest value in the mated application.

The format of the point codes in the CSPC group specified with the `grp` parameter must be the same as the primary point code specified with the `chg-map` command only if the ANSI/ITU SCCP Conversion feature is not enabled. If the ANSI/ITU SCCP Conversion feature is enabled, the CSPC group may contain a mixture of point code types (refer to the [Adding a Concerned Signaling Point Code](#) procedure), and the network type of the CSPC group can be different from the network type of the primary point code of the mated application. The status of the ANSI/ITU SCCP Conversion feature can be verified with the `rtrv-ctrl-feat` command.

Canceling the RTRV-MAP Command

Because the `rtrv-map` command used in this procedure can output information for a long period of time, the `rtrv-map` command can be canceled and the output to the terminal stopped. There are three ways that the `rtrv-map` command can be canceled.

- Press the F9 function key on the keyboard at the terminal where the `rtrv-map` command was entered.
- Enter the `canc-cmd` without the `trm` parameter at the terminal where the `rtrv-map` command was entered.
- Enter the `canc-cmd:trm=<xx>`, where `<xx>` is the terminal where the `rtrv-map` command was entered, from another terminal other than the terminal where the `rtrv-map` command was entered. To enter the `canc-cmd:trm=<xx>` command, the terminal must allow Security Administration commands to be entered from it and the user must be allowed to enter Security Administration commands. The terminal's permissions can be verified with the `rtrv-secu-trm` command. The user's permissions can be verified with the `rtrv-user` or `rtrv-secu-user` commands.

For more information about the `canc-cmd` command, refer to *Commands User's Guide*.

1. Display the mated applications in the database using the `rtrv-map` command.

This is an example of the possible output.

```
rlghncxa03w 09-07-07 00:34:31 GMT EAGLE5 41.1.0  
  
MAPSET ID=DFLT
```

```

PCA          Mate PCA      SSN RC MULT SRM MRC GRP NAME SSO WT %WT
THR
002-002-002          250 10  SHR *Y  *Y  grp15   ON  10  33
20
          100-130-079  250 10  SHR *Y  *Y  grp15   ON  10  33
20
          068-135-094  251 10  SHR *Y  *Y  grp05   OFF 10  33
20

MAPSET ID=10
PCA          Mate PCA      SSN RC MULT SRM MRC GRP NAME SSO WT %WT
THR
003-003-003          254 10  DOM YES YES  grp10   ON  --  ---
--
          040-040-040  254 20  DOM YES YES  grp10   ON  --  ---
--

MAPSET ID=11
PCA          Mate PCA      SSN RC MULT SRM MRC GRP NAME SSO WT %WT
THR
004-004-004          254 10  SHR *Y  *Y  grp10   OFF --  ---
--
          100-100-100  254 10  SHR *Y  *Y  grp10   OFF --  ---
--

MAPSET ID=DFLT
PCA          Mate PCA      SSN RC MULT SRM MRC GRP NAME SSO WT %WT
THR
005-005-005          250 10  DOM YES YES  grp15   OFF --  ---
--
          060-060-060  250 20  DOM YES YES  grp15   OFF --  ---
--
          070-070-070  251 30  DOM YES YES  grp05   ON  --  ---
--

MAPSET ID=9
PCA          Mate PCA      SSN RC MULT SRM MRC GRP NAME SSO WT %WT
THR
006-006-006          250 10  SOL *Y  *Y  grp15   OFF --  ---
--

MAPSET ID=DFLT
PCA          Mate PCA      SSN RC MULT SRM MRC GRP NAME SSO WT %WT
THR
007-007-007          251 10  SOL *Y  *Y  grp05   ON  --  ---
--

MAPSET ID=12
PCA          Mate PCA      SSN RC MULT SRM MRC GRP NAME SSO WT %WT
THR
008-008-008          254 10  COM YES *Y  grp10   ON  10  33
20
          200-147-100  254 10  COM YES *Y  grp10   ON  10  33
20
          179-183-050  250 10  COM YES *Y  grp15   OFF 10  33
    
```



```

20
          031-049-100  250 20  COM YES *Y  grp15   ON  10  50
20
          056-113-200  251 20  COM YES *Y  grp05   OFF 10  50
20

MAPSET ID=DFLT
PCA      Mate PCA      SSN RC MULT SRM MRC GRP NAME SSO WT %WT
THR
255-001-000          250 10  SOL *Y  *Y  grp01   ON  --  ---
--

MAPSET ID=1
PCA      Mate PCA      SSN RC MULT SRM MRC GRP NAME SSO WT %WT
THR
255-001-000          251 10  SHR *Y  *Y  grp01   OFF --  ---
--
          253-001-002  254 10  SHR *Y  *Y  grp01   OFF --  ---
--

MAPSET ID=2
PCA      Mate PCA      SSN RC MULT SRM MRC GRP NAME SSO WT %WT
THR
255-001-000          252 10  SOL *Y  *Y  grp01   ON  --  ---
--

MAPSET ID=DFLT
PCA      Mate PCA      SSN RC MULT SRM MRC GRP NAME SSO WT %WT
THR
255-001-000          253 10  SHR *Y  *Y  grp01   OFF --  ---
--
          253-001-004  254 10  SHR *Y  *Y  grp01   OFF --  ---
--

MAPSET ID=3
PCA      Mate PCA      SSN RC MULT SRM MRC GRP NAME SSO WT %WT
THR
255-001-001          255 10  DOM YES YES  grp01   ON  --  ---
--
          253-001-005  254 20  DOM YES YES  grp01   ON  --  ---
--

MAPSET ID=4
PCA      Mate PCA      SSN RC MULT SRM MRC GRP NAME SSO WT %WT
THR
255-001-001          250 10  DOM NO  NO  grp01   OFF --  ---
--
          253-001-001  254 20  DOM NO  NO  grp01   OFF --  ---
--

MAPSET ID=DFLT
PCA      Mate PCA      SSN RC MULT SRM MRC GRP NAME SSO WT %WT
THR
255-001-002          251 10  SHR *Y  *Y  grp01   OFF --  ---
--
          255-001-002  254 10  SHR *Y  *Y  grp01   OFF --  ---
--
    
```

```

MAPSET ID=5
PCA      Mate PCA      SSN RC MULT SRM MRC GRP NAME SSO WT %WT
THR
255-001-002      252 10  DOM YES YES grp01  ON  --  ---
--
                255-001-003 254 20  DOM YES YES grp01  ON  --  ---
--

MAPSET ID=6
PCA      Mate PCA      SSN RC MULT SRM MRC GRP NAME SSO WT %WT
THR
255-001-002      253 10  SHR *Y  *Y  grp01  ON  --  ---
--
                255-001-004 254 10  SHR *Y  *Y  grp01  ON  --  ---
--

MAPSET ID=7
PCI      Mate PCI      SSN RC MULT SRM MRC GRP NAME SSO WT %WT
THR
2-001-2          255 10  DOM YES YES grp03  OFF --  ---
--
                2-001-1    254 20  DOM YES YES grp03  OFF --  ---
--

MAPSET ID=8
PCN      Mate PCN      SSN RC MULT SRM MRC GRP NAME SSO WT %WT
THR
00347          253 10  SHR *N  *N  grp05  OFF --  ---
--
                01387      254 10  SHR *N  *N  grp05  OFF --  ---
--

MAP TABLE IS (37 of 36000) 1 % FULL

```

If any of the following items are not shown in the `rtrv-map` output, then the feature corresponding to these items is not enabled, or turned on if required.

- The `MAPSET` field - the Flexible GTT Load Sharing feature is not enabled.
- The `MRNSET` and `MRNPC` fields - the GTT Load Sharing with Alternate Routing Indicator feature is not enabled.
- The `WT`, `%WT`, `THR` columns - the Weighted GTT Load Sharing feature is not enabled and turned on.

If you wish to change the point code and SSN of a mated application, record the data for the mated application. Remove the mated application by performing the [Removing a Mated Application](#) procedure. Add the mated application with the new point code and SSN by performing the one of these procedures.

- [Provisioning a Solitary Mated Application](#)
- [Provisioning a Dominant Mated Application](#)
- [Provisioning a Load Shared Mated Application](#)
- [Provisioning a Combined Dominant/Load Shared Mated Application](#)

If the CSPC group name assigned to the mated application is not being changed, continue the procedure by performing one of these steps.

- If the `SSO` parameter value will not be changed, continue the procedure with 5.
- If the `SSO` parameter value will not be changed, continue the procedure with 4.

If the CSPC group name assigned to the mated application is being changed, continue the procedure with 2.

2. Display the point codes in the CSPC group that you wish to assign to the mated application by first entering the `rtrv-cspc` command with no parameters.

This is an example of the possible output.

```
rlghncxa03w 09-07-25 09:48:31 GMT EAGLE5 41.1.0
CSPC GRP   NETWORK                PERCENT FULL
grp01      ANSI                          6%
grp02      ITU-I                          9%
grp03      ITU-N                          12%
grp04      ANSI                          15%
grp05      ANSI                          15%
grp10      ANSI                          15%
grp15      ANSI                          15%
```

If the desired CSPC group is shown in the `rtrv-cspc` output, re-enter the `rtrv-cspc` command with the CSPC group name. For this example, enter this command.

```
rtrv-cspc:grp=grp05
```

This is an example of the possible output.

```
rlghncxa03w 09-07-25 09:48:31 GMT EAGLE5 41.1.0
CSPC GRP   PCA
grp05      005-005-005
           007-007-007
           008-008-008
           009-009-009
```

If the CSPC group is not in the database, or if the required point code is not assigned to the CSPC group, perform the [Adding a Concerned Signaling Point Code](#) procedure to add the required CSPC group or point code to the database. If the format of the point codes that will be assigned to the CSPC group created by performing the [Adding a Concerned Signaling Point Code](#) procedure will be different from the primary point code of the mated application, the ANSI/ITU SCCP conversion feature must be enabled when the [Adding a Concerned Signaling Point Code](#) procedure is performed. Continue the procedure by performing one of these steps.

- If the `SSO` parameter value will not be changed, continue the procedure with 5.
- If the `SSO` parameter value will not be changed, continue the procedure with 4.

If the CSPC group contains the required point codes, continue the procedure by performing one of these steps.

- If the CSPC group displayed in this step contains point codes with different formats (the ANSI/ITU SCCP Conversion feature is enabled), or if the format

of all the point codes in the CSPC group are the same as the primary point code of the mated application, continue the procedure by performing one of these steps.

- If the `SSO` parameter value will not be changed, continue the procedure with 5.
 - If the `SSO` parameter value will not be changed, continue the procedure with 4.
 - If the CSPC group displayed in this step contains point codes with the same format and the format of the primary point of the mated application is different, continue the procedure with 3.
3. The format of the point codes in the CSPC group specified with the `grp` parameter must be the same as the primary point code specified with the `ent-map` command only if the ANSI/ITU SCCP Conversion feature is not enabled.

If the ANSI/ITU SCCP Conversion feature is enabled, the CSPC group may contain a mixture of point code formats (refer to the [Adding a Concerned Signaling Point Code](#) procedure), and the network type of the CSPC group can be different from the network type of the primary point code of the mated application.

Verify the status of the ANSI/ITU SCCP Conversion feature by entering this command:

```
rtrv-ctrl-feat:partnum=893012001
```

The following is an example of the possible output.

```
rlghncxa03w 09-07-28 21:15:37 GMT EAGLE5 41.1.0
```

The following features have been permanently enabled:

Feature Name	Partnum	Status	Quantity
SCCP Conversion	893012001	on	----

The following features have been temporarily enabled:

Feature Name	Partnum	Status	Quantity	Trial
Period Left				
Zero entries found.				

The following features have expired temporary keys:

Feature Name	Partnum
Zero entries found.	

If the ANSI/ITU SCCP Conversion feature is not enabled, perform the [Activating the ANSI/ITU SCCP Conversion Feature](#) procedure to enable the ANSI/ITU SCCP Conversion feature.

Continue the procedure by performing one of these steps.

- If the `SSO` parameter value will not be changed, continue the procedure with 5.
 - If the `SSO` parameter value will not be changed, continue the procedure with 4.
4. The `SSO` parameter cannot be specified for a mated application if the `pc/pca/pci/pcn/pcn24` value is the EAGLE's point code. A load shared or combined dominant/load shared mated application cannot contain the EAGLE's

point code. A dominant mated application containing the EAGLE's point code can contain only one mate point code and SSN. The EAGLE's point code in the dominant mated application must have the lowest RC value.

Verify the EAGLE's point code by entering the `rtrv-sid` command. The EAGLE's point code is shown in the PCA, PCI, PCN, and PCN24 fields. This is an example of the possible output.

```
rlghncxa03w 09-07-10 11:43:04 GMT EAGLE5 41.1.0
  PCA          PCI          PCN
CLLI          PCTYPE
  010-020-030  1-023-1      12-0-14-1
rlghncxa03w  OTHER
              s-1-023-1  s-12-0-14-1

  CPCA
001-001-001  002-002-003  002-002-004  002-002-005
002-002-006  002-002-007  002-002-008  002-002-009
004-002-001  004-003-003  050-060-070

  CPCI
1-001-1      1-001-2      1-001-3      1-001-4
1-002-1      1-002-2      1-002-3      1-002-4
2-001-1      7-222-7

  CPCN
2-0-10-3     2-0-11-0     2-0-11-2     2-0-12-1
2-2-3-3     2-2-4-0     10-14-10-1
```

- Change the `rc`, `grp`, `sso`, `srm`, or `mrc` parameter values, as applicable, in the mated application using the `chg-map` command with the point code and subsystem number from the `rtrv-map` command output shown in [1](#).

If the `MAPSET` field is shown in the `rtrv-map` output in [1](#), the `mapset` parameter must be specified with the `chg-map` command. If the `MAPSET` field is not shown in the `rtrv-map` output in [1](#) the `mapset` parameter cannot be specified with the `chg-map` command.

For this example, enter this command.

```
chg-
map:pca=255-001-001:ssn=250:grp=grp05:srm=yes:mrc=yes:sso=on:
mapset=4
```

This message should appear.

```
rlghncxa03w 09-07-25 09:43:31 GMT EAGLE5 41.1.0
CHG-MAP: MASP A - COMPLTD
```

- Verify the changes using the `rtrv-map` command with the primary point code and subsystem specified in [5](#).

If the `mapset` parameter was specified in [5](#), the `mapset` parameter and value specified in [5](#) must be specified with the `rtrv-map` command in this step.

If the `mapset` parameter was not specified in [5](#), the `mapset` parameter cannot be specified with the `rtrv-map` command in this step.

For this example, enter this command.

```
rtrv-map:pca=255-001-001:ssn=250:mapset=4
```

This is an example of the possible output.

```
rlghncxa03w 09-07-07 00:34:31 GMT EAGLE5 41.1.0
```

```

MAPSET ID=4
PCA          Mate PCA          SSN RC MULT SRM MRC GRP NAME SSO WT
%WT THR
  255-001-001          250 10  DOM YES YES grp05   ON  --
---  ---
                253-001-001  254 20  DOM NO  NO  grp01   OFF --
---  ---

```

```
MAP TABLE IS (37 of 36000) 1 % FULL
```

7. Backup the new changes using the `chg-db:action=backup:dest=fixed` command. These messages should appear, the active Maintenance and Administration Subsystem Processor (MASP) appears first.

```

BACKUP (FIXED) : MASP A - Backup starts on active MASP.
BACKUP (FIXED) : MASP A - Backup on active MASP to fixed disk
complete.
BACKUP (FIXED) : MASP A - Backup starts on standby MASP.
BACKUP (FIXED) : MASP A - Backup on standby MASP to fixed disk
complete.

```

If you do not wish to change the mated application type, the weights or in-service thresholds of the mated application, or the MRNSET and MRN point code of the mated application, this procedure is finished.

If you wish to change the mated application type, the weights or in-service thresholds of the mated application, or the MRNSET and MRN point code of the mated application, perform these procedures as applicable.

- To change the mated application type of the mated application, perform the [Changing the Mated Application Type](#) procedure.
- To change the weights or in-service thresholds of the mated application, perform the [Changing the Weight and In-Service Threshold Values of a Mated Application](#) procedure.
- To change the MRNSET and MRN point code of the mated application, perform the [Changing the MRNSET and MRN Point Code Values of MAP Entries](#) procedure.

Figure 2-107 Change the Attributes of a Mated Application - Sheet 1 of 6

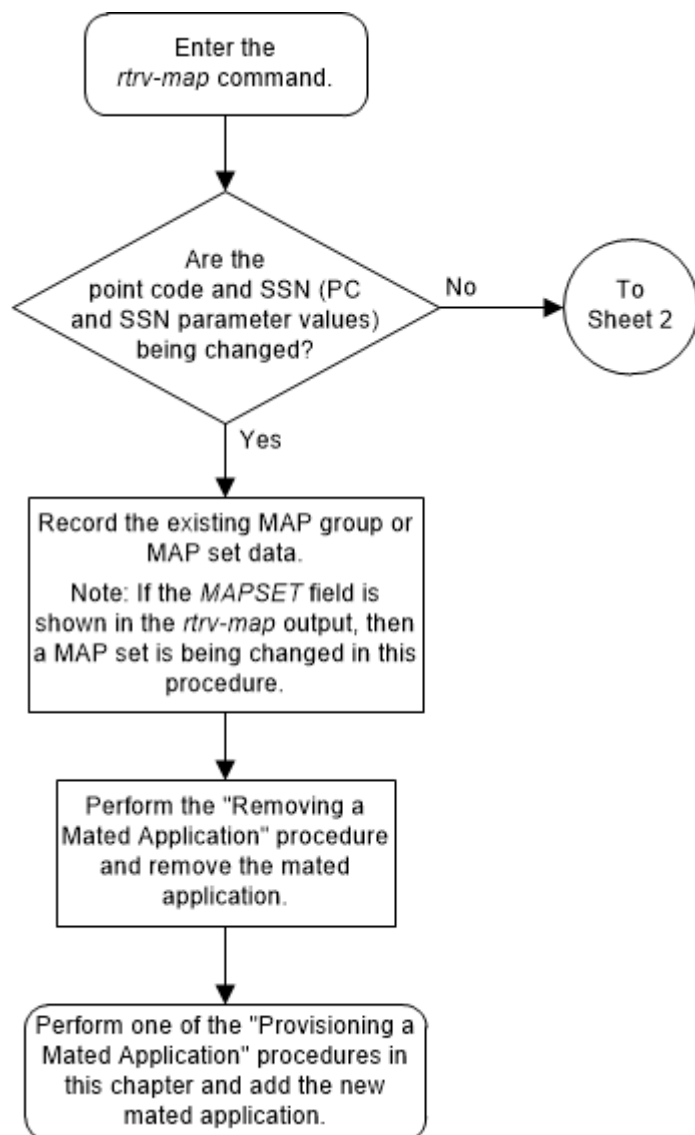

Figure 2-108 Change the Attributes of a Mated Application - Sheet 2 of 6

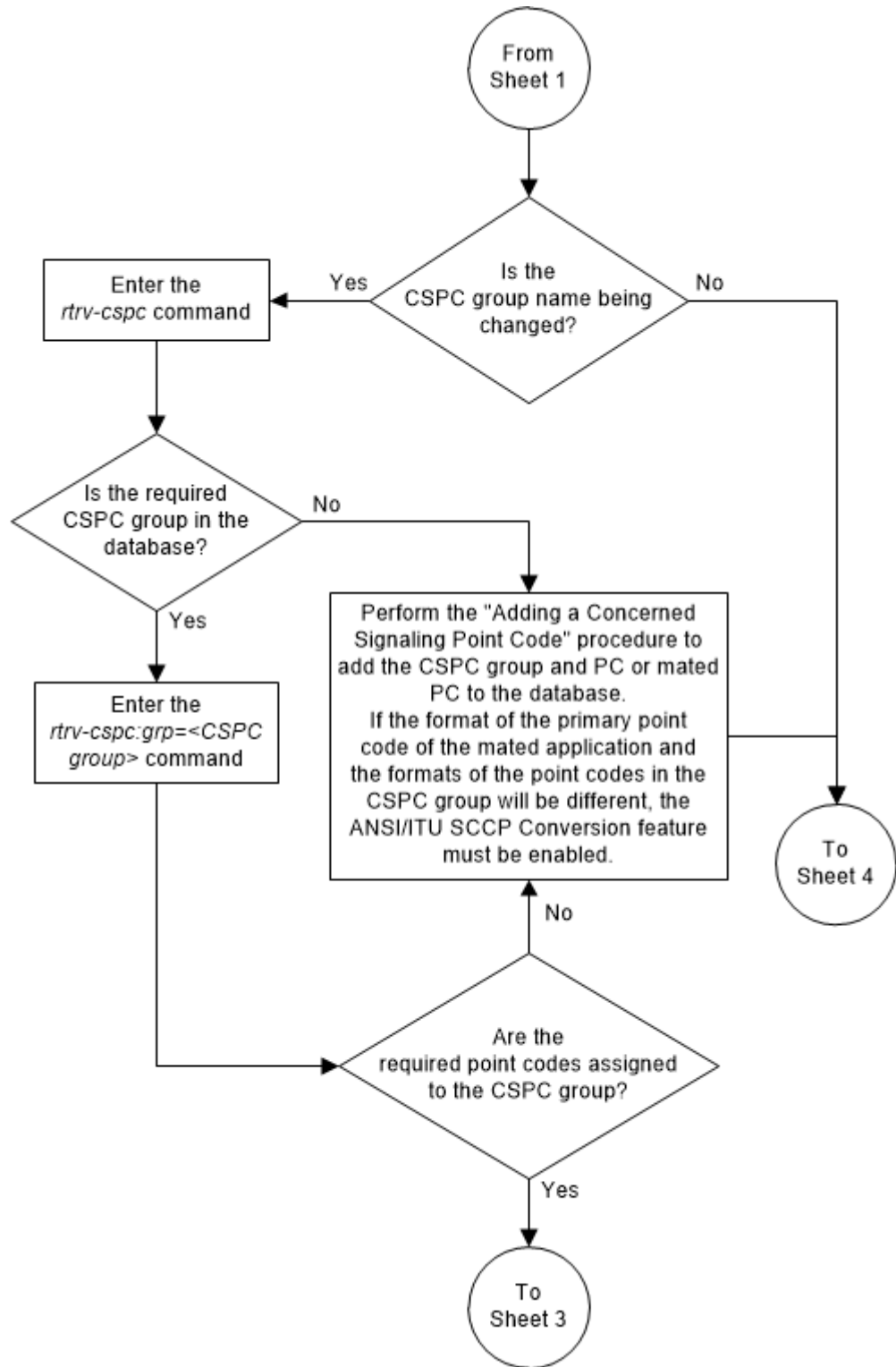

Figure 2-109 Change the Attributes of a Mated Application - Sheet 3 of 6

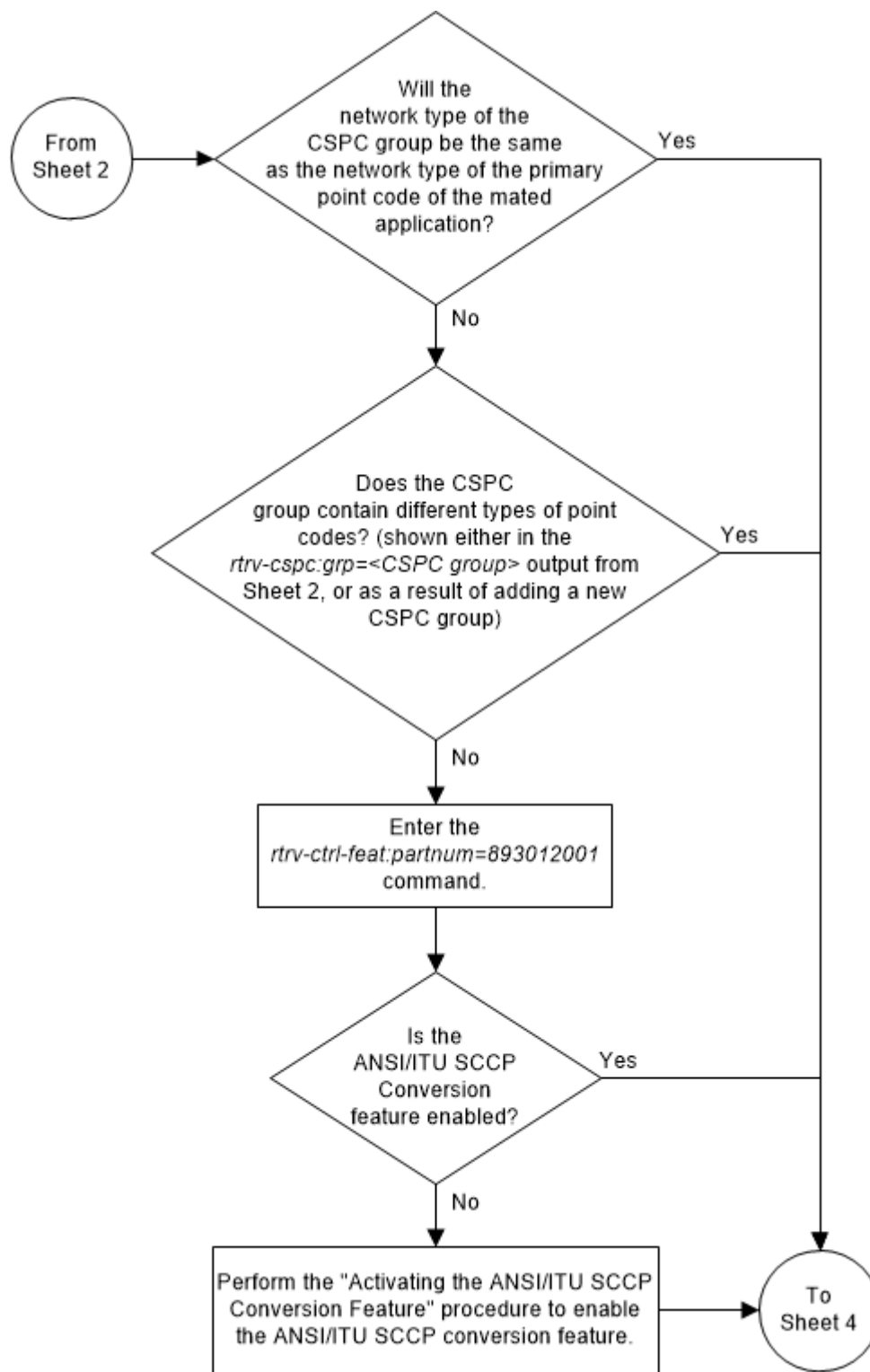

Figure 2-110 Change the Attributes of a Mated Application - Sheet 4 of 6

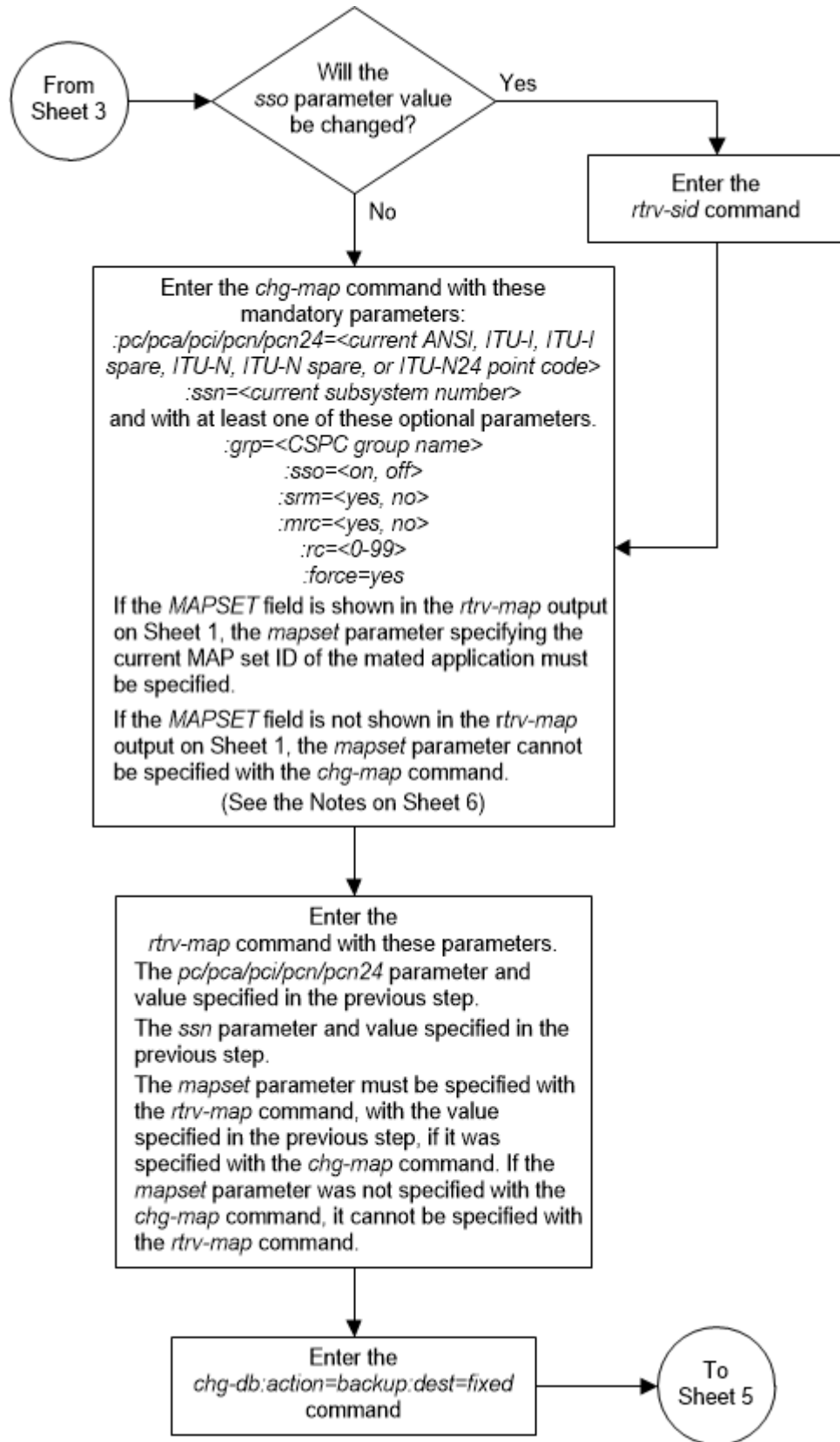

Figure 2-111 Change the Attributes of a Mated Application - Sheet 5 of 6

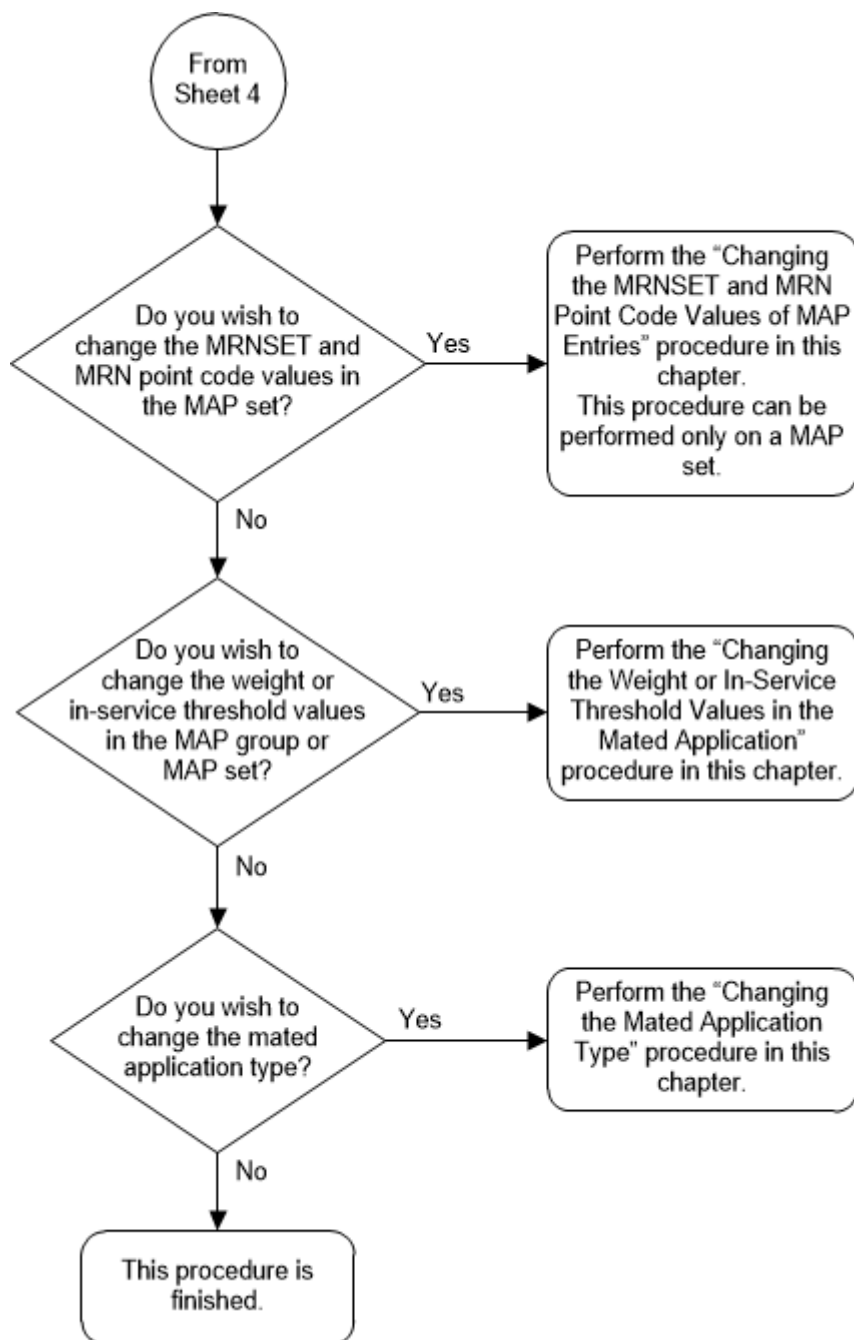

Figure 2-112 Change the Attributes of a Mated Application - Sheet 6 of 6

Notes:

1. A solitary mated application contains only one entry. The *rc* parameter can be specified for a solitary mated application, but is not necessary.
2. A dominant mated application is a MAP group or MAP set whose *rc* entries that are unique. If the *rc* value of a dominant mated application is being changed, make sure that the new *rc* value is unique.
3. A load shared mated application is a MAP group or MAP set whose *rc* entries that are equal. Specifying the *rc* parameter for an entry in a load shared mated application is not necessary. For the load shared mated application to remain a load shared mated application, the *rc* value for any entry cannot be changed to another value.
4. A combined dominant/load shared mated application is a MAP group or MAP set that contains entries with a minimum of two *rc* values that are equal and a minimum of one *rc* value that is different. If the *rc* value of a combined dominant/load shared mated application is being changed, make sure that the mated application contains a minimum of two *rc* values that are equal and a minimum of one *rc* value that is different.
5. The *sso* parameter cannot be specified if the point code value for the mated application is the EAGLE 5 ISS's point code, shown in the *rtrv-sid* output.
6. The format of the point codes in the CSPC group specified with the *grp* parameter must be the same as the primary point code specified with the *chg-map* command only if the ANSI/ITU SCCP Conversion feature is not enabled. If the ANSI/ITU SCCP Conversion feature is enabled, the CSPC group may contain a mixture of point code types (see the "Adding a Concerned Signaling Point Code" procedure in this chapter), and the network type of the CSPC group can be different from the network type of the primary point code of the mated application.
7. The mated application containing the EAGLE 5 ISS's point code, shown in the *rtrv-sid* output, can have only one mate point code assigned to it. The relative cost value assigned to the EAGLE 5 ISS's point code must be less than the relative cost value the mate point code. The EAGLE 5 ISS's true point code and subsystem cannot be specified for a load shared or combined dominant/load shared mated application.
8. The *mapset* parameter can be specified only, and must be specified, if the Flexible GTT Load Sharing feature is enabled. If the *rtrv-map* output contains the *MAPSET* column, the Flexible GTT Load Sharing feature is enabled.
9. If the Flexible GTT Load Sharing feature is enabled, the new *grp*, *mrc*, *sm*, or *sso* values specified in the *chg-map* command are applied to all mated applications containing the point code and SSN specified in the *chg-map* command.
10. The *sm=yes* parameter cannot be specified for mated applications containing ITU point codes (*pci/mpci*, *pcn/mpcn*, or *pcn24/mpcn24* parameter values).
11. The *force=yes* parameter must be specified and can be specified only when the *rc* and either the *sm* or *mrc* parameters are specified.
12. The value of the *mrc* parameter affects traffic only if the mated application is a dominant mated application.
13. The value of the *sm* parameter affects traffic only if the mated application is a dominant or combined dominant/load shared mated application.

Changing the Mated Application Type

This procedure is used to change the mated application type of an existing mated application (MAP) group or MAP set using the *chg-map* command with the *rc* parameter.

There are four types of mated applications.

- Solitary - A solitary mated application contains only one entry.
- Dominant - A dominant mated application contains more than one entry and the RC (relative cost) values of these entries are unique.

- Load Shared - A load shared mated application contains more than one entry and the RC values of these entries are equal.
- Combined Dominant/Load Shared - A combined dominant/load shared mated application contains more than one entry and must contain a minimum of two entries whose RC values are equal and one entry whose RC value is different.

The `chg-map` command contains other parameters that are not used in this procedure. Perform these procedures as applicable to change the other parameter values.

- To change the weights or in-service thresholds of the mated application, perform the [Changing the Weight and In-Service Threshold Values of a Mated Application](#) procedure.
- To change the MRNSET and MRN point code values assigned to the mated application, perform the [Changing the MRNSET and MRN Point Code Values of MAP Entries](#) procedure.
- To change other attributes of the mated application, perform the [Changing the Attributes of a Mated Application](#) procedure.

The `chg-map` command can also be used to add point code/SSN entries to an existing MAP group or MAP set. This action is not covered in this procedure. If you wish to add point code/SSN entries to an existing MAP group or MAP set, perform one of these procedures.

- [Provisioning a Solitary Mated Application](#)
- [Provisioning a Dominant Mated Application](#)
- [Provisioning a Load Shared Mated Application](#)
- [Provisioning a Combined Dominant/Load Shared Mated Application](#)

The `chg-map` command in this procedure uses these parameters.

`:pc/pca/pci/pcn/pcn24` – The point code of the primary signaling point that is to receive the message.

 **Note:**

The point codes can be either an ANSI point code (pc/pca), ITU-I or ITU-I spare point code (pci), a 14-bit ITU-N or 14-bit ITU-N spare point code (pcn), or a 24-bit ITU-N (pcn24) point code.

 **Note:**

Refer to Chapter 2, Configuring Destination Tables, in the *Database Administration - SS7 User's Guide* for a definition of the point code types that are used on the EAGLE and for a definition of the different formats that can be used for ITU national point codes.

`:ssn` – Subsystem number – the subsystem address of the primary point code that is to receive the message.

:rc – The relative cost value of the primary point code and subsystem, defined by the `pc/pca/pci/pcn/pcn24` and `ssn` parameters. The `rc` parameter has a range of values from 0 to 99.

:mapset – The MAP set ID that the mated applications are assigned to, shown in the `rtrv-map` output. MAP set IDs are shown only if the Flexible GTT Load Sharing feature is enabled. The `mapset` parameter value cannot be changed in this procedure. If the `rtrv-map` output shows the `MAPSET` field, the `mapset` parameter must be specified with the `chg-map` command. If the `rtrv-map` output does not show the `MAPSET` field, the Flexible GTT Load Sharing feature is not enabled. The `mapset` parameter cannot be specified with the `chg-map` command. The `mapset` parameter has two values.

- `dflt` – to change the mated application in the default MAP set. The EAGLE's true point code (shown in the `rtrv-sid` output) and subsystem can be assigned only to the default MAP set.
- the specific number of an existing MAP set if you are changing the mated application in an existing MAP set.

The mated application to be changed must be in the database.

If an existing dominant, load shared, or combined dominant/load shared mated application is being changed to a solitary mated application, the existing mated application must be removed from the database, and the new solitary mated application, containing the primary point code and subsystem from the mated application that was removed, must be added to the database.

If the mated application contains the EAGLE's true point code, the relative cost value assigned to this point code must be the lowest value in the mated application.

Canceling the RTRV-MAP Command

Because the `rtrv-map` command used in this procedure can output information for a long period of time, the `rtrv-map` command can be canceled and the output to the terminal stopped. There are three ways that the `rtrv-map` command can be canceled.

- Press the `F9` function key on the keyboard at the terminal where the `rtrv-map` command was entered.
- Enter the `canc-cmd` without the `trm` parameter at the terminal where the `rtrv-map` command was entered.
- Enter the `canc-cmd:trm=<xx>`, where `<xx>` is the terminal where the `rtrv-map` command was entered, from another terminal other than the terminal where the `rtrv-map` command was entered. To enter the `canc-cmd:trm=<xx>` command, the terminal must allow Security Administration commands to be entered from it and the user must be allowed to enter Security Administration commands. The terminal's permissions can be verified with the `rtrv-secu-trm` command. The user's permissions can be verified with the `rtrv-user` or `rtrv-secu-user` commands.

For more information about the `canc-cmd` command, refer to *Commands User's Guide*.

1. Display the mated applications in the database using the `rtrv-map` command.

This is an example of the possible output.

rlghncxa03w 09-07-07 00:34:31 GMT EAGLE5 41.1.0

MAPSET ID=DFLT

PCA	Mate	PCA	SSN	RC	MULT	SRM	MRC	GRP	NAME	SSO	WT	%WT
THR												
002-002-002			250	10	SHR	*Y	*Y	grp15		ON	10	33
20												
		100-130-079	250	10	SHR	*Y	*Y	grp15		ON	10	33
20												
		068-135-094	251	10	SHR	*Y	*Y	grp05		OFF	10	33
20												

MAPSET ID=10

PCA	Mate	PCA	SSN	RC	MULT	SRM	MRC	GRP	NAME	SSO	WT	%WT
THR												
003-003-003			254	10	DOM	YES	YES	grp10		ON	--	---
--												
		040-040-040	254	20	DOM	YES	YES	grp10		ON	--	---
--												

MAPSET ID=11

PCA	Mate	PCA	SSN	RC	MULT	SRM	MRC	GRP	NAME	SSO	WT	%WT
THR												
004-004-004			254	10	SHR	*Y	*Y	grp10		OFF	--	---
--												
		100-100-100	254	10	SHR	*Y	*Y	grp10		OFF	--	---
--												

MAPSET ID=DFLT

PCA	Mate	PCA	SSN	RC	MULT	SRM	MRC	GRP	NAME	SSO	WT	%WT
THR												
005-005-005			250	10	DOM	YES	YES	grp15		OFF	--	---
--												
		060-060-060	250	20	DOM	YES	YES	grp15		OFF	--	---
--												
		070-070-070	251	30	DOM	YES	YES	grp05		ON	--	---
--												

MAPSET ID=9

PCA	Mate	PCA	SSN	RC	MULT	SRM	MRC	GRP	NAME	SSO	WT	%WT
THR												
006-006-006			250	10	SOL	*Y	*Y	grp15		OFF	--	---
--												

MAPSET ID=DFLT

PCA	Mate	PCA	SSN	RC	MULT	SRM	MRC	GRP	NAME	SSO	WT	%WT
THR												
007-007-007			251	10	SOL	*Y	*Y	grp05		ON	--	---
--												

MAPSET ID=12

PCA	Mate	PCA	SSN	RC	MULT	SRM	MRC	GRP	NAME	SSO	WT	%WT
THR												

```

008-008-008          254 10  COM YES *Y  grp10   ON  10  33
20
          200-147-100  254 10  COM YES *Y  grp10   ON  10  33
20
          179-183-050  250 10  COM YES *Y  grp15   OFF 10  33
20
          031-049-100  250 20  COM YES *Y  grp15   ON  10  50
20
          056-113-200  251 20  COM YES *Y  grp05   OFF 10  50
20
    
```

MAPSET ID=DFLT

```

PCA          Mate PCA      SSN RC MULT SRM MRC GRP NAME SSO WT %WT
THR
255-001-000          250 10  SOL *Y  *Y  grp01   ON  --  ---
--
    
```

MAPSET ID=1

```

PCA          Mate PCA      SSN RC MULT SRM MRC GRP NAME SSO WT %WT
THR
255-001-000          251 10  SHR *Y  *Y  grp01   OFF --  ---
--
          253-001-002  254 10  SHR *Y  *Y  grp01   OFF --  ---
--
    
```

MAPSET ID=2

```

PCA          Mate PCA      SSN RC MULT SRM MRC GRP NAME SSO WT %WT
THR
255-001-000          252 10  SOL *Y  *Y  grp01   ON  --  ---
--
    
```

MAPSET ID=DFLT

```

PCA          Mate PCA      SSN RC MULT SRM MRC GRP NAME SSO WT %WT
THR
255-001-000          253 10  SHR *Y  *Y  grp01   OFF --  ---
--
          253-001-004  254 10  SHR *Y  *Y  grp01   OFF --  ---
--
    
```

MAPSET ID=3

```

PCA          Mate PCA      SSN RC MULT SRM MRC GRP NAME SSO WT %WT
THR
255-001-001          255 10  DOM YES YES  grp01   ON  --  ---
--
          253-001-005  254 20  DOM YES YES  grp01   ON  --  ---
--
    
```

MAPSET ID=4

```

PCA          Mate PCA      SSN RC MULT SRM MRC GRP NAME SSO WT %WT
THR
255-001-001          250 10  DOM NO  NO  grp01   OFF --  ---
--
          253-001-001  254 20  DOM NO  NO  grp01   OFF --  ---
--
    
```

MAPSET ID=DFLT

```

PCA          Mate PCA      SSN RC MULT SRM MRC GRP NAME SSO WT %WT
    
```



```

THR
255-001-002          251 10  SHR *Y  *Y  grp01   OFF -- ---
--
--          255-001-002 254 10  SHR *Y  *Y  grp01   OFF -- ---
--

MAPSET ID=5
PCA      Mate PCA      SSN RC MULT SRM MRC GRP NAME SSO WT %WT
THR
255-001-002          252 10  DOM YES YES  grp01   ON  -- ---
--
--          255-001-003 254 20  DOM YES YES  grp01   ON  -- ---
--

MAPSET ID=6
PCA      Mate PCA      SSN RC MULT SRM MRC GRP NAME SSO WT %WT
THR
255-001-002          253 10  SHR *Y  *Y  grp01   ON  -- ---
--
--          255-001-004 254 10  SHR *Y  *Y  grp01   ON  -- ---
--

MAPSET ID=7
PCI      Mate PCI      SSN RC MULT SRM MRC GRP NAME SSO WT %WT
THR
2-001-2          255 10  DOM YES YES  grp03   OFF -- ---
--
--          2-001-1     254 20  DOM YES YES  grp03   OFF -- ---
--

MAPSET ID=8
PCN      Mate PCN      SSN RC MULT SRM MRC GRP NAME SSO WT %WT
THR
00347          253 10  SHR *N  *N  grp05   OFF -- ---
--
--          01387       254 10  SHR *N  *N  grp05   OFF -- ---
--

MAP TABLE IS (37 of 36000) 1 % FULL

```

If any of the following items are not shown in the `rtrv-map` output, then the feature corresponding to these items is not enabled, or turned on if required.

- The `MAPSET` field - the Flexible GTT Load Sharing feature is not enabled.
- The `MRNSET` and `MRNPC` fields - the GTT Load Sharing with Alternate Routing Indicator feature is not enabled.
- The `WT`, `%WT`, `THR` columns - the Weighted GTT Load Sharing feature is not enabled and turned on.

If a solitary mated application is being changed to a dominant, load shared, or combined dominant/load shared mated application, perform one of these procedures.

- [Provisioning a Dominant Mated Application](#)

- [Provisioning a Load Shared Mated Application](#)
- [Provisioning a Combined Dominant/Load Shared Mated Application](#)

If you wish to change a dominant, load shared, or combined dominant/load shared mated application to a solitary mated application, record the data for the mated application. Remove the mated application by performing the [Removing a Mated Application](#) procedure. Add the solitary mated application with the point code and SSN from the previous mated application by performing the [Provisioning a Solitary Mated Application](#) procedure.

If the mated application being changed is not a solitary mated application, continue the procedure by performing one of these steps.

- If the mated application is being changed to a dominant mated application, continue the procedure with [3](#).

 **Note:**

If the mated application contains weight and in-service threshold values, when this mated application is changed to a dominant mated application, the weight and in-service threshold values will be removed from the mated application.

- If the mated application is being changed to a load shared mated application or a combined dominant/load Shared mated application, continue the procedure with [2](#).
2. Display the EAGLE's point code by entering the rtrv-sid command. A load shared or combined dominant/load shared mated application cannot contain the EAGLE's point code.

The EAGLE's point code is shown in the PCA, PCI, PCN, and PCN24 fields. This is an example of the possible output.

```

rlghncxa03w 09-07-10 11:43:04 GMT EAGLE5 41.1.0
      PCA          PCI          PCN
CLLI          PCTYPE
  010-020-030    1-023-1      12-0-14-1
rlghncxa03w          OTHER
                  s-1-023-1    s-12-0-14-1

      CPCA
001-001-001      002-002-003      002-002-004      002-002-005
002-002-006      002-002-007      002-002-008      002-002-009
004-002-001      004-003-003      050-060-070

      CPCI
1-001-1          1-001-2          1-001-3          1-001-4
1-002-1          1-002-2          1-002-3          1-002-4
2-001-1          7-222-7

      CPCN
2-0-10-3        2-0-11-0        2-0-11-2        2-0-12-1
2-2-3-3        2-2-4-0        10-14-10-1

```

If the EAGLE's point code is shown in the mated application that is being changed, record the mated application data. Remove the mated application by performing the [Removing a Mated Application](#) procedure. Add the new mated application by performing the [Provisioning a Load Shared Mated Application](#) or [Provisioning a Combined Dominant/Load Shared Mated Application](#) procedures.

If the EAGLE's point code is not shown in the mated application that is being changed, continue the procedure with 3.

3. Change the `rc` parameter values in the mated application to produce the desired mated application type.

If the `MAPSET` field is shown in the `rtrv-map` output in 1, the `mapset` parameter must be specified with the `chg-map` command. If the `MAPSET` field is not shown in the `rtrv-map` output in 1, the `mapset` parameter cannot be specified with the `chg-map` command.

If a dominant mated application is being created, the `rc` parameter values for this mated application must be unique. If the mated application has weight and in-service threshold values assigned to it, when this mated application is changed to a dominant mated application, the `WT`, `%WT`, and `THR` values are removed from the mated application and are not displayed in the `rtrv-map` output.

If a load shared mated application is being created, the `rc` parameter values for this mated application must be equal.

If a combined dominant/load shared mated application is being created, a minimum of 2 entries must contain `rc` parameter values that are equal and a minimum of one entry must contain an `rc` parameter value that is different.

For these examples, these types of changes are being made.

- A dominant mated application is changed to a load shared mated application.
- A load shared mated application is changed to a dominant mated application.
- A combined dominant/load shared mated application is changed to a load shared mated application.

To change a dominant mated application to a load shared mated application, for this example enter these commands.

```
chg-map:pca=060-060-060:ssn=250:mapset=df1t:rc=10
```

```
chg-map:pca=070-070-070:ssn=251:mapset=df1t:rc=10
```

To change a load shared mated application to a dominant mated application, for this example enter these commands.

```
chg-map:pca=100-130-079:ssn=250:mapset=df1t:rc=20
```

```
chg-map:pca=068-135-094:ssn=251:mapset=df1t:rc=30
```

To change a combined dominant/load shared mated application to a load shared mated application, for this example enter these commands.

```
chg-map:pca=031-049-100:ssn=250:mapset=12:rc=10
```

```
chg-map:pca=056-113-200:ssn=251:mapset=12:rc=10
```

4. Verify the changes using the `rtrv-map` command with the one of the primary point codes and subsystems specified in 3 for the MAP set or MAP group that was changed. If the `mapset` parameter was specified in 3, the `mapset` parameter and value specified in 3 must be specified with the `rtrv-map` command in this step.

For these examples, enter these commands.

```
rtrv-map:pca=060-060-060:ssn=250:mapset=df1t
```

This is an example of the possible output.

```
rlghncxa03w 09-07-07 00:34:31 GMT EAGLE5 41.1.0
```

```
MAPSET ID=DFLT
```

PCA	Mate	PCA	SSN	RC	MULT	SRM	MRC	GRP	NAME	SSO	WT	%WT
005-005-005			250	10	SHR	*Y	*Y	grp15		OFF	--	---
		060-060-060	250	10	SHR	*Y	*Y	grp15		OFF	--	---
		070-070-070	251	10	SHR	*Y	*Y	grp05		ON	--	---

```
MAP TABLE IS (37 of 36000) 1 % FULL
```

```
rtrv-map:pca=100-130-079:ssn=250:mapset=df1t
```

This is an example of the possible output.

```
rlghncxa03w 09-07-07 00:34:31 GMT EAGLE5 41.1.0
```

```
MAPSET ID=DFLT
```

PCA	Mate	PCA	SSN	RC	MULT	SRM	MRC	GRP	NAME	SSO	WT	%WT
002-002-002			250	10	DOM	YES	YES	grp15		ON	--	---
		100-130-079	250	20	DOM	YES	YES	grp15		ON	--	---
		068-135-094	251	30	DOM	YES	YES	grp05		OFF	--	---

```
MAP TABLE IS (37 of 36000) 1 % FULL
```

```
rtrv-map:pca=031-049-100:ssn=250:mapset=12
```

This is an example of the possible output.

```
rlghncxa03w 09-07-07 00:34:31 GMT EAGLE5 41.1.0
```

```
MAPSET ID=12
```

PCA	Mate	PCA	SSN	RC	MULT	SRM	MRC	GRP	NAME	SSO	WT	%WT
008-008-008			254	10	SHR	*Y	*Y	grp10		ON	10	20
20		200-147-100	254	10	SHR	*Y	*Y	grp10		ON	10	20
20		179-183-050	250	10	SHR	*Y	*Y	grp15		OFF	10	20
20		031-049-100	250	10	SHR	*Y	*Y	grp15		ON	10	20
20												

```
056-113-200 251 10 SHR *Y *Y grp05 OFF 10 20
20
MAP TABLE IS (37 of 36000) 1 % FULL
```

5. Backup the new changes using the `chg-db:action=backup:dest=fixed` command. These messages should appear, the active Maintenance and Administration Subsystem Processor (MASP) appears first.

```
BACKUP (FIXED) : MASP A - Backup starts on active MASP.
BACKUP (FIXED) : MASP A - Backup on active MASP to fixed disk
complete.
BACKUP (FIXED) : MASP A - Backup starts on standby MASP.
BACKUP (FIXED) : MASP A - Backup on standby MASP to fixed disk
complete.
```

If you do not wish to change the weights or in-service thresholds of the mated application, the MRNSET and MRN point code of the mated application, or other attributes of the mated application, this procedure is finished.

If you wish to change the the weights or in-service thresholds of the mated application, the MRNSET and MRN point code of the mated application, or other attributes of the mated application, perform these procedures as applicable.

- To change the weights or in-service thresholds of the mated application, perform the [Changing the Weight and In-Service Threshold Values of a Mated Application](#) procedure.
- To change the MRNSET and MRN point code of the mated application, perform the [Changing the MRNSET and MRN Point Code Values of MAP Entries](#) procedure.
- To change other attributes of the mated application, perform the [Changing the Attributes of a Mated Application](#) procedure.

Figure 2-113 Change the Mated Application Type - Sheet 1 of 6

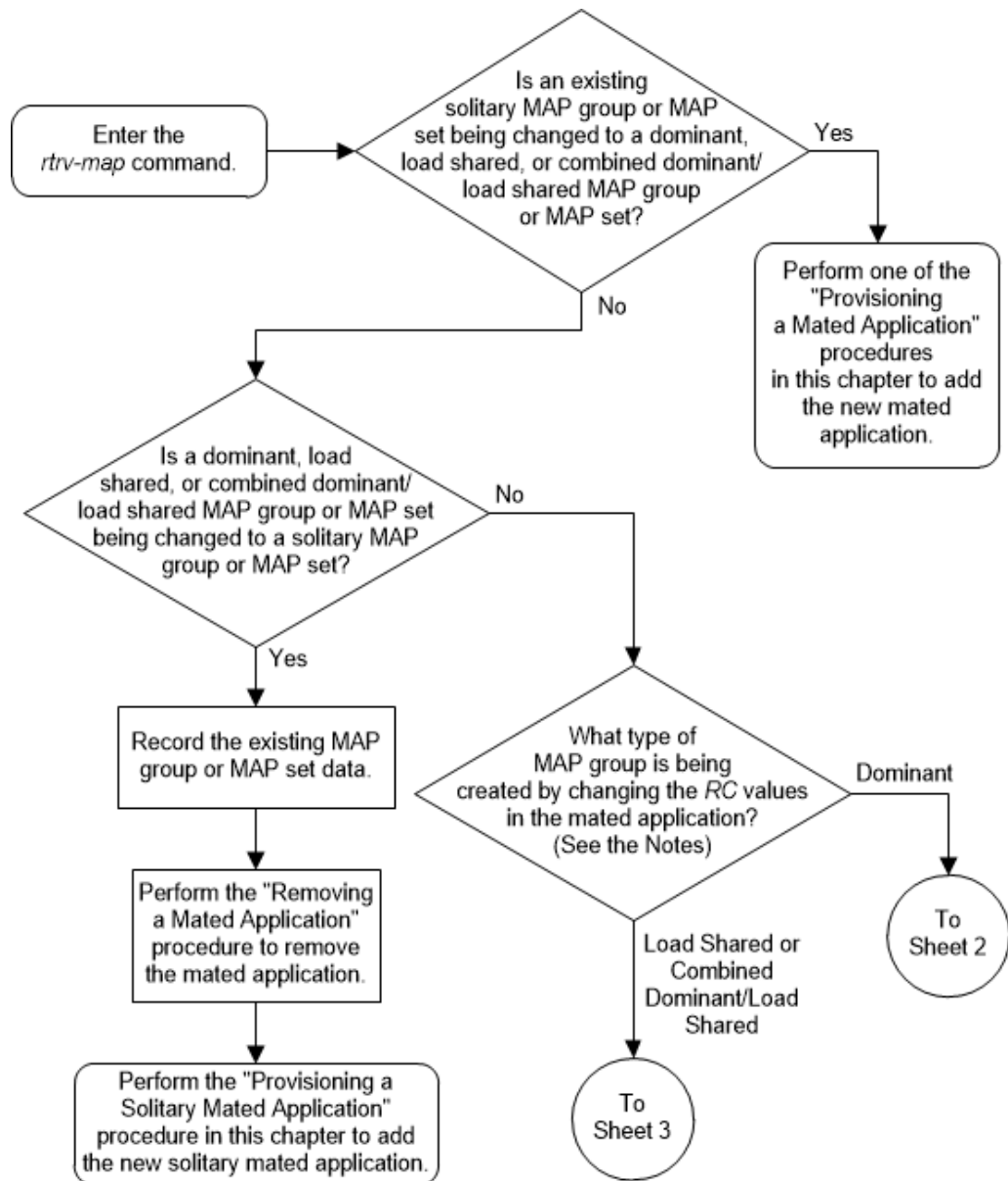

Notes:

1. The mated application containing the EAGLE 5 ISS's point code can have only one mate point code assigned to it. The relative cost value assigned to the EAGLE 5 ISS's point code must be less than the relative cost value the mate point code. The EAGLE 5 ISS's true point code and subsystem cannot be specified for a load shared or combined dominant/load shared mated application.
2. If the mated application being changed is either a load shared or combined dominant/load shared mated application, and this mated application has weight and in-service threshold values assigned, when this mated application is changed to a dominant mated application, the weight and in-service threshold values will be removed from the mated application.

Figure 2-114 Change the Mated Application Type - Sheet 2 of 6

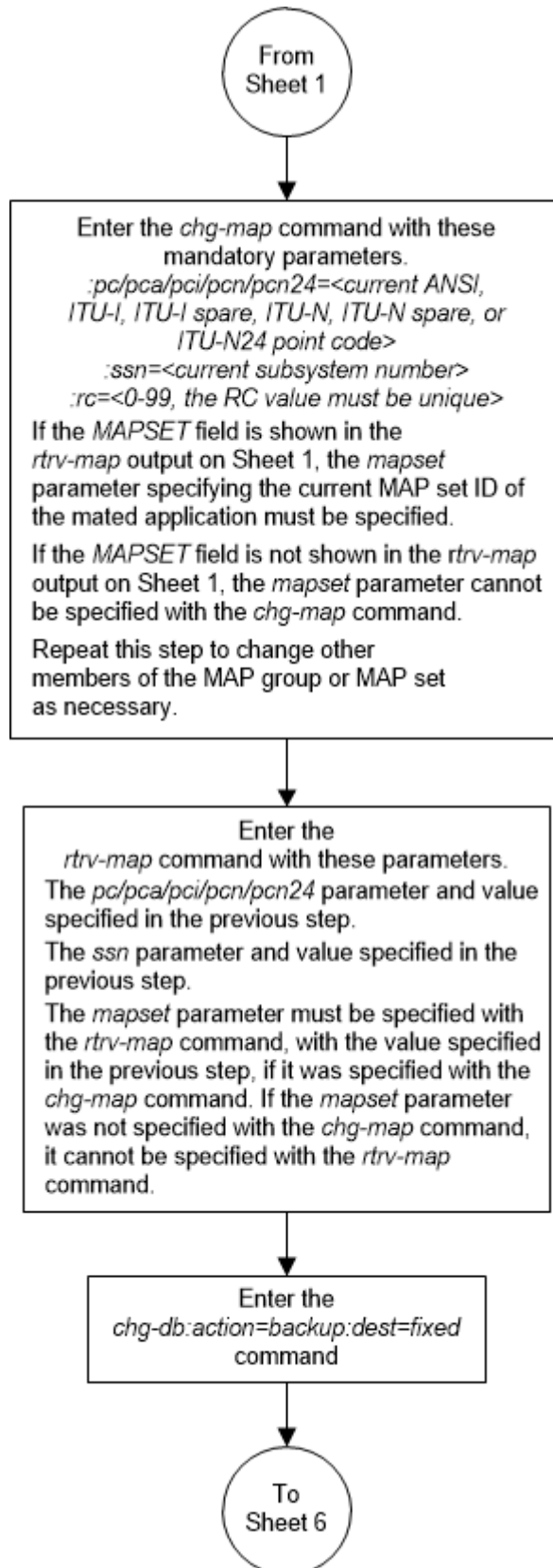

Figure 2-115 Change the Mated Application Type - Sheet 3 of 6

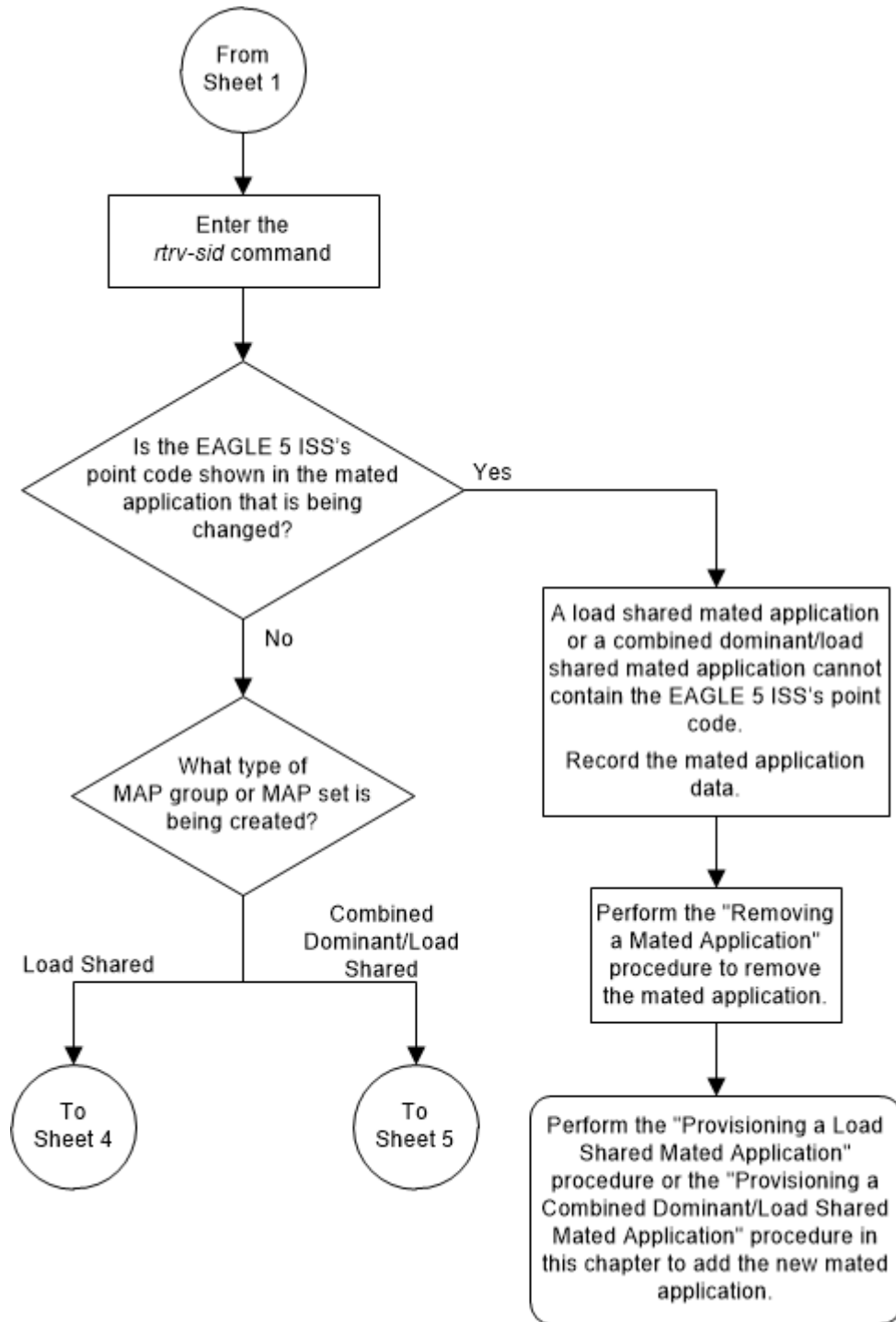

Figure 2-116 Change the Mated Application Type - Sheet 4 of 6

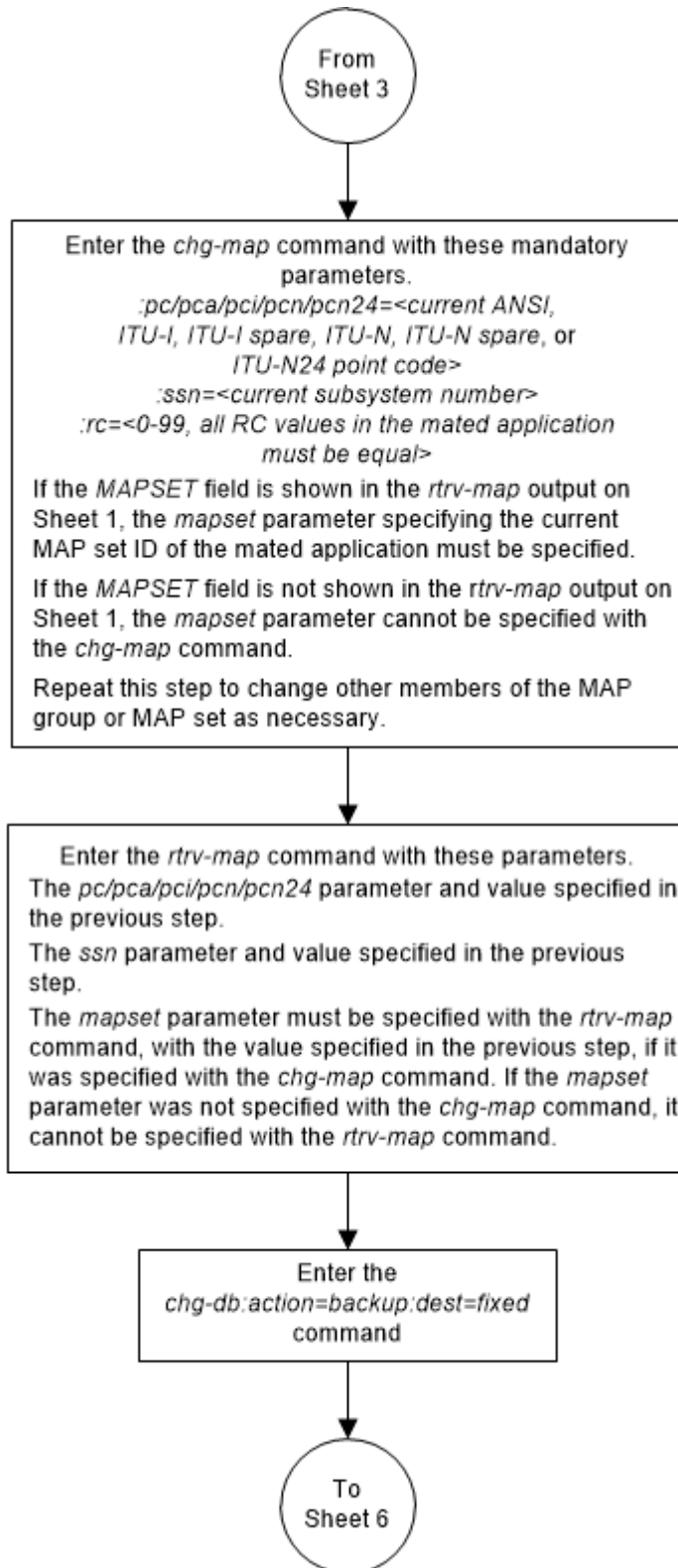

Figure 2-117 Change the Mated Application Type - Sheet 5 of 6

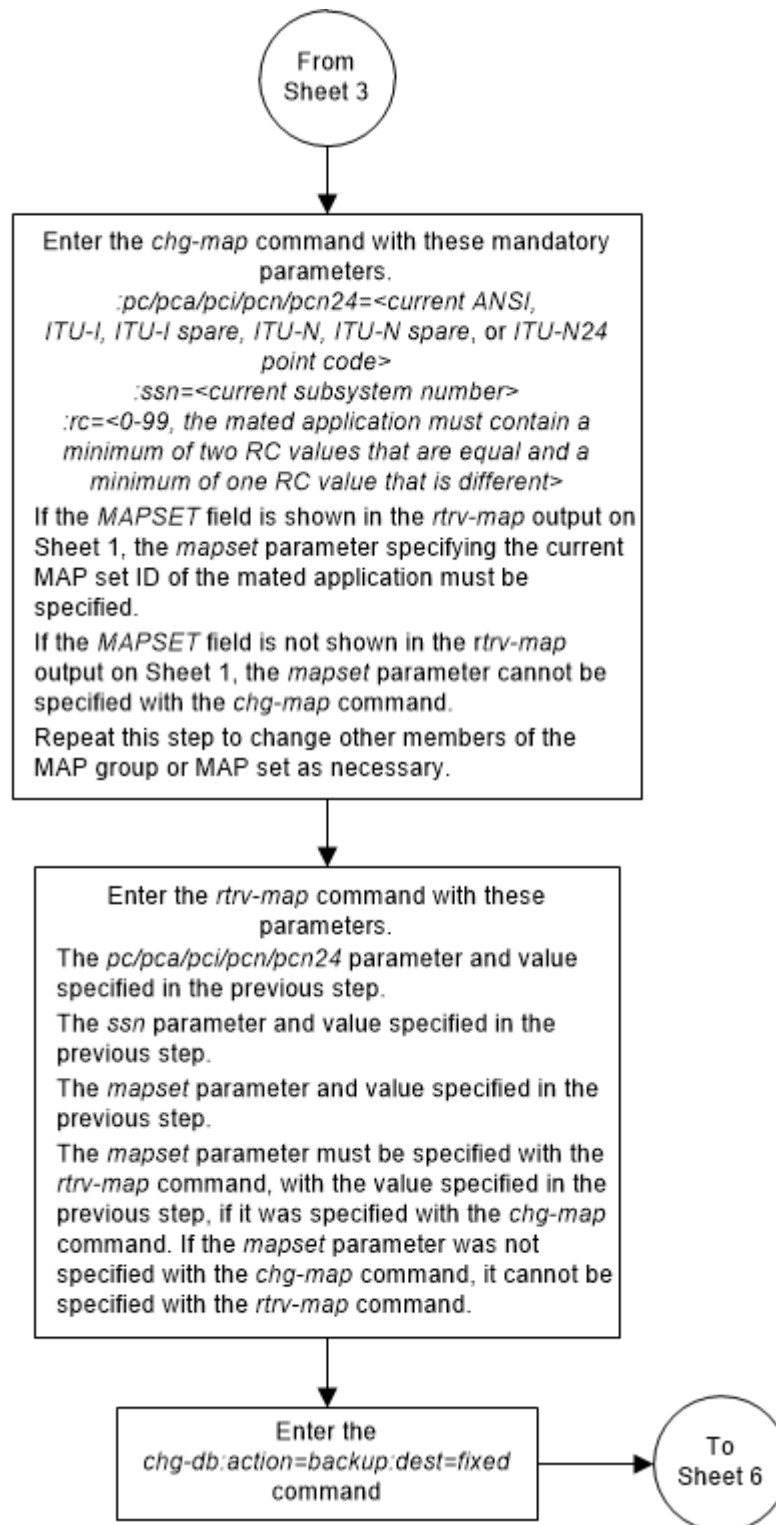
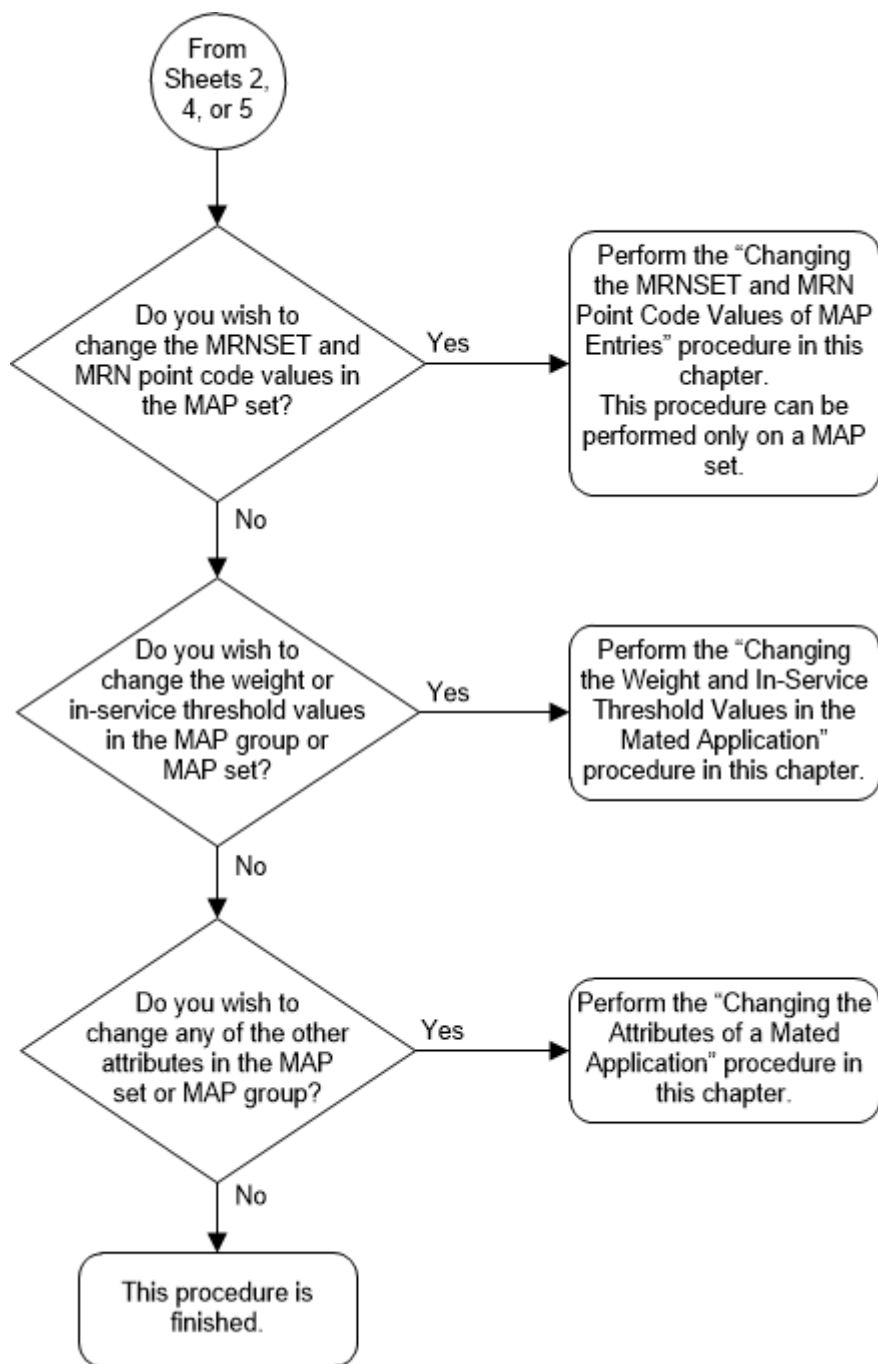

Figure 2-118 Change the Mated Application Type - Sheet 6 of 6



Changing the Weight and In-Service Threshold Values of a Mated Application

This procedure is used to change the weight and in-service threshold values, for the Weighted GTT Load Sharing feature, that are assigned to the entries in an existing

mated application (MAP) group or MAP set using the `chg-map` command with the parameters shown in [Table 2-53](#).

Table 2-53 Mated Application Weight and In-Service Threshold Parameters

wt	eswt	grpwt	thr
----	------	-------	-----

The `eswt`, `grpwt`, `wt`, and `thr` parameters can be used only if the MAP group or MAP set is either a load shared or combined dominant/load shared MAP group or MAP set, and the Weighted GTT Load Sharing feature is enabled and turned on.

A load shared mated application contains more than one entry and the RC values of these entries are equal. A combined dominant/load shared mated application contains more than one entry and must contain a minimum of two entries whose RC values are equal and one entry whose RC value is different.

The status of the Weighted GTT Load Sharing feature can be verified by entering the `rtrv-ctrl-feat` command. If the Weighted GTT Load Sharing feature is not enabled or not turned on, perform the [Activating the Weighted GTT Load Sharing Feature](#) procedure to enable and turn on the Weighted GTT Load Sharing feature.

The `rc` parameter can also be specified in this procedure. Changing the `rc` value of the mated application in this procedure is not performed to change the mated application type. If you wish to change the mated application type, perform the [Changing the Mated Application Type](#) procedure.

The `chg-map` command contains other parameters that are not used in this procedure. Perform these procedures as applicable to change the other parameter values.

- To change the MRNSET and MRN point code values assigned to the mated application, perform the [Changing the MRNSET and MRN Point Code Values of MAP Entries](#) procedure.
- To change other attributes of the mated application, perform the [Changing the Attributes of a Mated Application](#) procedure.

The `chg-map` command can also be used to add point code/SSN entries to an existing MAP group or MAP set. This action is not covered in this procedure. If you wish to add point code/SSN entries to an existing MAP group or MAP set, perform one of these procedures.

- [Provisioning a Solitary Mated Application](#)
- [Provisioning a Dominant Mated Application](#)
- [Provisioning a Load Shared Mated Application](#)
- [Provisioning a Combined Dominant/Load Shared Mated Application](#)

The `chg-map` command uses these parameters.

`:pc/pca/pci/pcn/pcn24` – The point code of the primary signaling point that is to receive the message.

 **Note:**

The point codes can be either an ANSI point code (pc/pca, mpc/mpca), ITU-I or ITU-I spare point code (pci, mpci), a 14-bit ITU-N or 14-bit ITU-N spare point code (pcn, mpcn), or a 24-bit ITU-N (pcn24, mpcn24) point code.

 **Note:**

Refer to Chapter 2, Configuring Destination Tables, in *Database Administration - SS7 User's Guide* for a definition of the point code types that are used on the EAGLE and for a definition of the different formats that can be used for ITU national point codes.

:*ssn* – Subsystem number – the subsystem address of the primary point code that is to receive the message.

:*rc* – The relative cost value of the primary point code and subsystem, defined by the *pc/pca/pci/pcn/pcn24* and *ssn* parameters. The *rc* parameter has a range of values from 0 to 99.

:*mapset* – The MAP set ID that the mated applications are assigned to, shown in the *rtrv-map* output. MAP set IDs are shown only if the Flexible GTT Load Sharing feature is enabled. The *mapset* parameter value cannot be changed in this procedure. If the *rtrv-map* output shows the MAPSET field, the *mapset* parameter must be specified with the *chg-map* command. If the *rtrv-map* output does not show the MAPSET field, the Flexible GTT Load Sharing feature is not enabled. The *mapset* parameter cannot be specified with the *chg-map* command. The *mapset* parameter has two values.

- *df1t* – to change the mated application in the default MAP set. The EAGLE's true point code (shown in the *rtrv-sid* output) and subsystem can be assigned only to the default MAP set.
- the specific number of an existing MAP set if you are changing the mated application in an existing MAP set.

:*eswt* – The entity set weight value. When this parameter is specified, the same weight value is assigned to all entries in the MAP group or MAP set that contain the point code value specified in the *chg-map* command. A MAP group or MAP set can also be referred to as an entity set. The value of this parameter is from 1 - 99.

:*grpwt* – The group weight value. When this parameter is specified, the same weight value is assigned to all entries that have the same RC (relative cost) value in the MAP group or MAP set that contain the point code specified in the *chg-map* command. The value of this parameter is from 1 - 99.

 **Note:**

Specifying the `grpwt` parameter for a load shared mated application has the same effect as specifying the `eswt` parameter for a load shared mated application as all the entries in a load shared mated application have the same RC value.

`:wt` – The weight value assigned to a specific point code and SSN entry in the mated application. The value of this parameter is from 1 - 99. This parameter allows for each entry in the mated application to have a different weight value.

`:thr` – The in-service threshold assigned to the MAP group or MAP set. The in-service threshold is the minimum percentage (from 1 - 100) of weight that must be available for an RC group (a group of entries in the MAP group or MAP set that have the same RC value assigned) to be considered available to carry traffic. If the percentage of the available weight is less than the in-service threshold, then the entire RC group is considered unavailable for traffic. If the percentage of the available weight is equal to or greater than the in-service threshold, then the RC group is considered available, and traffic can be sent to any available entity in the RC group. When the `thr` parameter is specified with the `eswt` parameter, the in-service threshold value is assigned to all the entries of the MAP group or MAP set. When the `thr` parameter is specified with the `grpwt` parameter, or without either the `eswt` or `grpwt` parameters, the in-service threshold value is assigned to all the entries of the MAP group or MAP set that have the same RC value as the point code specified with the `chg-map` command.

`:force=yes` – This parameter must be specified if the `rc` parameter is specified with the `wt` parameter.

Weighted GTT Load Sharing allows unequal traffic loads to be provisioned in MAP load sharing groups or MAP load sharing sets. This feature also allows provisioning control over load sharing groups or sets so that if insufficient capacity within the load sharing group or set is available, the load sharing group or set is not used.

The weight and in-service threshold values for a mated application are shown in the `rtrv-map` output. The weight values assigned to the entires in the MAP group or MAP set are shown in the `WT` column in the `rtrv-map` output.

The `%WT` column in the `rtrv-map` output shows the percentage of the traffic the particular entry in the entity set will handle.

The in-service threshold values assigned to the entires in the MAP group or MAP set are shown in the `THR` column in the `rtrv-map` output.

The `WT`, `%WT`, and `THR` columns are shown in the `rtrv-map` output only if the Weighted GTT Load Sharing feature is enabled and turned on.

For more information on the Weighted GTT Load Sharing feature, refer to the [Weighted GTT Load Sharing](#) section.

The mated application to be changed must be in the database.

Canceling the RTRV-MAP Command

Because the `rtrv-map` command used in this procedure can output information for a long period of time, the `rtrv-map` command can be canceled and the output to

the terminal stopped. There are three ways that the `rtrv-map` command can be canceled.

- Press the F9 function key on the keyboard at the terminal where the `rtrv-map` command was entered.
- Enter the `canc-cmd` without the `trm` parameter at the terminal where the `rtrv-map` command was entered.
- Enter the `canc-cmd:trm=<xx>`, where `<xx>` is the terminal where the `rtrv-map` command was entered, from another terminal other than the terminal where the `rtrv-map` command was entered. To enter the `canc-cmd:trm=<xx>` command, the terminal must allow Security Administration commands to be entered from it and the user must be allowed to enter Security Administration commands. The terminal's permissions can be verified with the `rtrv-secu-trm` command. The user's permissions can be verified with the `rtrv-user` or `rtrv-secu-user` commands.

For more information about the `canc-cmd` command, refer to *Commands User's Guide*.

1. Display the mated applications in the database using the `rtrv-map` command.

This is an example of the possible output.

```
rlghncxa03w 09-07-07 00:34:31 GMT EAGLE5 41.1.0

      MAPSET ID=DFLT
      PCA          Mate PCA          SSN RC MULT SRM MRC GRP NAME SSO WT
%WT THR
002-002-002          250 10  SHR *Y  *Y  grp15  ON  10
33  20
      100-130-079  250 10  SHR *Y  *Y  grp15  ON  10
33  20
      068-135-094  251 10  SHR *Y  *Y  grp05  OFF 10
33  20

      MAPSET ID=10
      PCA          Mate PCA          SSN RC MULT SRM MRC GRP NAME SSO WT
%WT THR
003-003-003          254 10  DOM YES YES grp10  ON  --
---  --
      040-040-040  254 20  DOM YES YES grp10  ON  --
---  --

      MAPSET ID=11
      PCA          Mate PCA          SSN RC MULT SRM MRC GRP NAME SSO WT
%WT THR
004-004-004          254 10  SHR *Y  *Y  grp10  OFF --
---  --
      100-100-100  254 10  SHR *Y  *Y  grp10  OFF --
---  --

      MAPSET ID=DFLT
      PCA          Mate PCA          SSN RC MULT SRM MRC GRP NAME SSO WT
%WT THR
005-005-005          250 10  SHR *Y  *Y  grp15  OFF --
```

```

--- --
          060-060-060  250 10  SHR *Y *Y  grp15  OFF --
--- --
          070-070-070  251 10  SHR *Y *Y  grp05  ON  --
--- --

MAPSET ID=9
PCA      Mate PCA      SSN RC MULT SRM MRC GRP NAME SSO WT
%WT THR
006-006-006          250 10  SOL *Y *Y  grp15  OFF --
--- --

MAPSET ID=DFLT
PCA      Mate PCA      SSN RC MULT SRM MRC GRP NAME SSO WT
%WT THR
007-007-007          251 10  SOL *Y *Y  grp05  ON  --
--- --

MAPSET ID=12
PCA      Mate PCA      SSN RC MULT SRM MRC GRP NAME SSO WT
%WT THR
008-008-008          254 10  COM YES *Y  grp10  ON  10
33  20
          200-147-100  254 10  COM YES *Y  grp10  ON  10
33  20
          179-183-050  250 10  COM YES *Y  grp15  OFF 10
33  20
          031-049-100  250 20  COM YES *Y  grp15  ON  10
50  20
          056-113-200  251 20  COM YES *Y  grp05  OFF 10
50  20

MAPSET ID=DFLT
PCA      Mate PCA      SSN RC MULT SRM MRC GRP NAME SSO WT
%WT THR
255-001-000          250 10  SOL *Y *Y  grp01  ON  --
--- --

MAPSET ID=1
PCA      Mate PCA      SSN RC MULT SRM MRC GRP NAME SSO WT
%WT THR
255-001-000          251 10  SHR *Y *Y  grp01  OFF --
--- --
          253-001-002  254 10  SHR *Y *Y  grp01  OFF --
--- --

MAPSET ID=2
PCA      Mate PCA      SSN RC MULT SRM MRC GRP NAME SSO WT
%WT THR
255-001-000          252 10  SOL *Y *Y  grp01  ON  --
--- --

MAPSET ID=DFLT
PCA      Mate PCA      SSN RC MULT SRM MRC GRP NAME SSO WT
%WT THR

```



```

255-001-000          253 10  SHR *Y  *Y  grp01  OFF --
--- --
          253-001-004  254 10  SHR *Y  *Y  grp01  OFF --
--- --
MAPSET ID=3
PCA      Mate PCA      SSN RC  MULT SRM MRC GRP NAME SSO WT
%WT THR
255-001-001          255 10  DOM YES YES  grp01  ON  --
--- --
          253-001-005  254 20  DOM YES YES  grp01  ON  --
--- --

MAPSET ID=4
PCA      Mate PCA      SSN RC  MULT SRM MRC GRP NAME SSO WT
%WT THR
255-001-001          250 10  DOM NO  NO   grp01  OFF --
--- --
          253-001-001  254 20  DOM NO  NO   grp01  OFF --
--- --

MAPSET ID=DFLT
PCA      Mate PCA      SSN RC  MULT SRM MRC GRP NAME SSO WT
%WT THR
255-001-002          251 10  SHR *Y  *Y  grp01  OFF --
--- --
          255-001-002  254 10  SHR *Y  *Y  grp01  OFF --
--- --

MAPSET ID=5
PCA      Mate PCA      SSN RC  MULT SRM MRC GRP NAME SSO WT
%WT THR
255-001-002          252 10  DOM YES YES  grp01  ON  --
--- --
          255-001-003  254 20  DOM YES YES  grp01  ON  --
--- --

MAPSET ID=6
PCA      Mate PCA      SSN RC  MULT SRM MRC GRP NAME SSO WT
%WT THR
255-001-002          253 10  SHR *Y  *Y  grp01  ON  --
--- --
          255-001-004  254 10  SHR *Y  *Y  grp01  ON  --
--- --

MAPSET ID=7
PCI      Mate PCI      SSN RC  MULT SRM MRC GRP NAME SSO WT
%WT THR
2-001-2            255 10  DOM YES YES  grp03  OFF --
--- --
          2-001-1            254 20  DOM YES YES  grp03  OFF --
--- --

MAPSET ID=8
PCN      Mate PCN      SSN RC  MULT SRM MRC GRP NAME SSO WT
%WT THR

```

```

00347                253 10  SHR *N *N  grp05  OFF --
--- --
                01387  254 10  SHR *N *N  grp05  OFF --
--- --

```

```
MAP TABLE IS (37 of 36000) 1 % FULL
```

If any of the following items are not shown in the `rtrv-map` output, then the feature corresponding to these items is not enabled, or turned on if required.

- The `MAPSET` field - the Flexible GTT Load Sharing feature is not enabled.
- The `MRNSET` and `MRNPC` fields - the GTT Load Sharing with Alternate Routing Indicator feature is not enabled.
- The `WT`, `%WT`, `THR` columns - the Weighted GTT Load Sharing feature is not enabled and turned on.

If the `WT`, `%WT`, `THR` columns are not shown in the `rtrv-map` output, perform the [Activating the Weighted GTT Load Sharing Feature](#) procedure to enable and turn on the Weighted GTT Load Sharing feature.

After the Weighted GTT Load Sharing feature has been enabled and turned on, or if the `rtrv-map` output shows that the Weighted GTT Load Sharing feature is enabled and turned on, continue the procedure by performing one of these actions.

- If the mated application that will be changed is a solitary or dominant mated application, perform the [Changing the Mated Application Type](#) procedure to change the mated application to either a load shared mated application or a combined dominant/load shared mated application. After the mated application has been changed, continue the procedure with [2](#).
 - If the mated application that will be changed is a load shared or combined dominant/load shared mated application, continue the procedure with [2](#).
2. There are several ways to change the weight and in-service threshold values in a MAP group or MAP set.

Perform one or more of these substeps to change the weight and in-service threshold values in a MAP group or MAP set.

Note:

If the `MAPSET` field is shown in the `rtrv-map` output in [1](#), the `mapset` parameter and the MAP set ID of the mated application that is being changed must be specified with the `chg-map` command. If the `MAPSET` field is not shown in the `rtrv-map` output in [1](#), the `mapset` parameter cannot be specified with the `chg-map` command.

- a. To assign the same weight value to each entry in the MAP group or MAP set, or to remove the weight and in-service threshold values for a MAP group or MAP set, specify these parameters with the `chg-map` command.
- `:pc/pca/pci/pcn/pcn24`
 - `ssn`

- `eswt`

To assign the same weight value to each entry in the MAP group or MAP set, for this example enter this command.

```
chg-map:pca=005-005-005:ssn=250:eswt=30:mapset=df1t
```

If the MAP group or MAP set did not have weight and in-service threshold values assigned before this substep was performed, the in-service threshold value 1 (1%) is assigned to the entries.

To remove the weight and in-service threshold values for each entry in the MAP group or MAP set, for this example enter this command.

```
chg-map:pca=008-008-008:ssn=254:eswt=none:mapset=df1t
```

- b.** To assign the same weight value and the in-service threshold value to all the entries in the MAP group or MAP set, specify these parameters with the `chg-map` command.

- `:pc/pca/pci/pcn/pcn24`
- `ssn`
- `eswt`
- `thr`

For this example, enter this command.

```
chg-map:pca=005-005-005:ssn=250:eswt=20:thr=30:mapset=df1t
```

- c.** To change only the weight value for an individual entry in the MAP group or MAP set, specify these parameters with the `chg-map` command

- `:pc/pca/pci/pcn/pcn24`
- `ssn`
- `wt`

For this example, enter this command.

```
chg-map:pca=008-008-008:ssn=254:wt=30:mapset=12
```

This substep can be repeated for other entries in the MAP group or MAP set.

- d.** To change the weight value for an individual entry in the MAP group or MAP set, and to change the RC value for that entry, specify these parameters with the `chg-map` command

- `:pc/pca/pci/pcn/pcn24`
- `ssn`
- `wt`
- `rc`
- `force=yes`

For this example, enter this command.

```
chg-  
map:pca=008-008-008:ssn=254:wt=30:rc=20:mapset=12:force=ye  
s
```

The `force=yes` parameter must be specified with the `chg-map` command if the `wt` and `rc` parameters are specified with the `chg-map` command

Changing the RC value of the mated application in this substep is not performed to change the mated application type. If you wish to change the mated application type, perform the [Changing the Mated Application Type](#) procedure.

This substep can be repeated for other entries in the MAP group or MAP set.

- e. To change only the in-service threshold of the MAP group or MAP set, specify these parameters with the `chg-map` command.

- `:pc/pca/pci/pcn/pcn24`
- `ssn`
- `thr`

For this example, enter this command.

```
chg-map:pca=008-008-008:ssn=254:thr=30:mapset=12
```

Changing only the in-service threshold for a MAP group or MAP set can be performed only if the MAP group or MAP set contains weight and in-service threshold values.

If the mated application is a combined dominant/load shared mated application, the in-service threshold value was changed only for all the entries that are in the RC group that contains the entry specified in this command. This substep can be repeated for other RC groups in the MAP group or MAP set.

If the mated application is a load shared mated application, the in-service threshold value was changed for all entries in the MAP group or MAP set.

- f. To change the weight values for all entries in an RC group in the MAP group or MAP set, specify these parameters with the `chg-map` command.

- `:pc/pca/pci/pcn/pcn24`
- `ssn`
- `grpwt`

For this example, enter this command.

```
chg-map:pca=008-008-008:ssn=254:grpwt=30:mapset=12
```

Changing the weight values for all entries in an RC group in the MAP group or MAP set can be performed only if the MAP group or MAP set contains weight and in-service threshold values.

Specifying the `grpwt` parameter for a load shared mated application has the same effect as specifying the `eswt` parameter for a load shared mated application as all the entries in a load shared mated application have the same RC value.

If the MAP group or MAP set did not have weight and in-service threshold values assigned before this substep was performed, the in-service threshold value 1 (1%) is assigned to the entries.

This substep can be repeated for other RC groups in the MAP group or MAP set.

- g.** To change the weight and the in-service threshold values for all entries in an RC group in the MAP group or MAP set, specify these parameters with the `chg-map` command.

- `:pc/pca/pci/pcn/pcn24`
- `ssn`
- `grpwt`
- `thr`

For this example, enter this command.

```
chg-map:pca=008-008-008:ssn=254:grpwt=20:thr=30:mapset=12
```

Changing the weight and in-service threshold values for all entries in an RC group in the MAP group or MAP set can be performed only if the MAP group or MAP set contains weight and in-service threshold values.

Specifying the `grpwt` parameter for a load shared mated application has the same effect as specifying the `eswt` parameter for a load shared mated application as all the entries in a load shared mated application have the same RC value.

This substep can be repeated for other RC groups in the MAP group or MAP set.

When the `chg-map` command has successfully completed, this message should appear.

```
rlghncxa03w 09-07-07 11:44:13 GMT EAGLE5 41.1.0
CHG-MAP: MASP A - COMPLTD
```

- 3.** Verify the changes using the `rtrv-map` command with the primary point code and subsystem specified in [2](#).

If the `mapset` parameter was specified in [2](#), the `mapset` parameter and value specified in [2](#) must be specified with the `rtrv-map` command in this step.

If the `mapset` parameter was not specified in [2](#), the `mapset` parameter cannot be specified with the `rtrv-map` command in this step.

- a.** If the same weight value was assigned to each entry in the MAP group or MAP set in substep 2a, for this example enter this command.

```
rtrv-map:pca=005-005-005:ssn=250:mapset=df1t
```

This is an example of the possible output.

```
rlghncxa03w 09-07-07 00:34:31 GMT EAGLE5 41.1.0

MAPSET ID=DFLT
PCA          Mate PCA      SSN RC MULT SRM MRC GRP NAME SSO WT
%WT THR
  005-005-005          250 10  SHR *Y *Y  grp15  OFF
30 33  1
          060-060-060  250 10  SHR *Y *Y  grp15  OFF
30 33  1
          070-070-070  251 10  SHR *Y *Y  grp05  ON
30 33  1
```

```
MAP TABLE IS (37 of 36000) 1 % FULL
```

- b.** If the weight and in-service threshold values were removed from the MAP group or MAP set in substep 2a, for this example enter this command.

```
rtrv-map:pca=008-008-008:ssn=254:mapset=df1t
```

This is an example of the possible output.

```
rlghncxa03w 09-07-07 00:34:31 GMT EAGLE5 41.1.0
```

```
MAPSET ID=12
PCA          Mate PCA          SSN RC MULT SRM MRC GRP NAME SSO WT
%WT THR
008-008-008          254 10 COM YES *Y grp10  ON  --
--- --
          200-147-100 254 10 COM YES *Y grp10  ON  --
--- --
          179-183-050 250 10 COM YES *Y grp15  OFF --
--- --
          031-049-100 250 20 COM YES *Y grp15  ON  --
--- --
          056-113-200 251 20 COM YES *Y grp05  OFF --
--- --
```

```
MAP TABLE IS (37 of 36000) 1 % FULL
```

- c.** If the same weight value and the in-service threshold value was assigned to each entry in the MAP group or MAP set in substep 2b, for this example enter this command.

```
rtrv-map:pca=005-005-005:ssn=250:mapset=df1t
```

This is an example of the possible output.

```
rlghncxa03w 09-07-07 00:34:31 GMT EAGLE5 41.1.0
```

```
MAPSET ID=DFLT
PCA          Mate PCA          SSN RC MULT SRM MRC GRP NAME SSO WT
%WT THR
005-005-005          250 10 SHR *Y *Y grp15  OFF
20 33 30
          060-060-060 250 10 SHR *Y *Y grp15  OFF
20 33 30
          070-070-070 251 10 SHR *Y *Y grp05  ON
20 33 30
```

```
MAP TABLE IS (37 of 36000) 1 % FULL
```

- d.** If the weight value for an individual entry in the MAP group or MAP set was changed in substep 2c, for this example enter this command.

```
rtrv-map:pca=008-008-008:ssn=254:mapset=df1t
```

This is an example of the possible output.

```
rlghncxa03w 09-07-07 00:34:31 GMT EAGLE5 41.1.0

      MAPSET ID=12
      PCA          Mate PCA          SSN RC MULT SRM MRC GRP NAME SSO WT
%WT THR
      008-008-008          254 10  COM YES *Y  grp10  ON
30  60  20
      200-147-100  254 10  COM YES *Y  grp10  ON
10  20  20
      179-183-050  250 10  COM YES *Y  grp15  OFF
10  20  20
      031-049-100  250 20  COM YES *Y  grp15  ON
10  50  20
      056-113-200  251 20  COM YES *Y  grp05  OFF
10  50  20

MAP TABLE IS (37 of 36000) 1 % FULL
```

- e. If the weight value for an individual entry in the MAP group or MAP set and its RC value was changed in substep 2d, for this example enter this command.

```
rtrv-map:pca=008-008-008:ssn=254:mapset=df1t
```

This is an example of the possible output.

```
rlghncxa03w 09-07-07 00:34:31 GMT EAGLE5 41.1.0

      MAPSET ID=12
      PCA          Mate PCA          SSN RC MULT SRM MRC GRP NAME SSO WT
%WT THR
      200-147-100          254 10  COM YES *Y  grp10  ON
10  50  20
      179-183-050  250 10  COM YES *Y  grp15  OFF
10  50  20
      031-049-100  250 20  COM YES *Y  grp15  ON
10  20  20
      056-113-200  251 20  COM YES *Y  grp05  OFF
10  20  20
      008-008-008  254 20  COM YES *Y  grp10  ON
30  60  20

MAP TABLE IS (37 of 36000) 1 % FULL
```

- f. If only the in-service threshold value of the MAP group or MAP set in substep 2e, for this example enter this command.

```
rtrv-map:pca=008-008-008:ssn=254:mapset=df1t
```

This is an example of the possible output.

```
rlghncxa03w 09-07-07 00:34:31 GMT EAGLE5 41.1.0

      MAPSET ID=12
```

```

PCA          Mate PCA          SSN RC MULT SRM MRC GRP NAME SSO WT
%WT THR
008-008-008          254 10  COM YES *Y  grp10  ON
10  33  30
200-147-100  254 10  COM YES *Y  grp10  ON
10  33  30
179-183-050  250 10  COM YES *Y  grp15  OFF
10  33  30
031-049-100  250 20  COM YES *Y  grp15  ON
10  50  20
056-113-200  251 20  COM YES *Y  grp05  OFF
10  50  20

MAP TABLE IS (37 of 36000) 1 % FULL

```

- g.** If the weight values for all entries in an RC group in the MAP group or MAP set in substep 2f, for this example enter this command.

```
rtrv-map:pca=008-008-008:ssn=254:mapset=df1t
```

This is an example of the possible output.

```

rlghncxa03w 09-07-07 00:34:31 GMT EAGLE5 41.1.0

MAPSET ID=12
PCA          Mate PCA          SSN RC MULT SRM MRC GRP NAME SSO WT
%WT THR
008-008-008          254 10  COM YES *Y  grp10  ON
30  33  20
200-147-100  254 10  COM YES *Y  grp10  ON
30  33  20
179-183-050  250 10  COM YES *Y  grp15  OFF
30  33  20
031-049-100  250 20  COM YES *Y  grp15  ON
10  50  20
056-113-200  251 20  COM YES *Y  grp05  OFF
10  50  20

MAP TABLE IS (37 of 36000) 4 % FULL

```

- h.** If the weight and in-service threshold values for all entries in an RC group in the MAP group or MAP set in substep 2g, for this example enter this command.

```
rtrv-map:pca=008-008-008:ssn=254:mapset=df1t
```

This is an example of the possible output.

```

rlghncxa03w 09-07-07 00:34:31 GMT EAGLE5 41.1.0

MAPSET ID=12
PCA          Mate PCA          SSN RC MULT SRM MRC GRP NAME SSO WT
%WT THR
008-008-008          254 10  COM YES *Y  grp10  ON
20  33  30
200-147-100  254 10  COM YES *Y  grp10  ON
20  33  30

```



```

                179-183-050  250 10  COM YES *Y  grp15  OFF
20  33  30
                031-049-100  250 20  COM YES *Y  grp15  ON
10  50  20
                056-113-200  251 20  COM YES *Y  grp05  OFF
10  50  20

```

```
MAP TABLE IS (37 of 36000) 1 % FULL
```

4. Backup the new changes using the `chg-db:action=backup:dest=fixed` command. These messages should appear, the active Maintenance and Administration Subsystem Processor (MASP) appears first.

```

BACKUP (FIXED) : MASP A - Backup starts on active MASP.
BACKUP (FIXED) : MASP A - Backup on active MASP to fixed disk
complete.
BACKUP (FIXED) : MASP A - Backup starts on standby MASP.
BACKUP (FIXED) : MASP A - Backup on standby MASP to fixed disk
complete.

```

If you do not wish to change the MRNSET and MRN point code of the mated application or other attributes of the mated application, this procedure is finished.

If you wish to change the MRNSET and MRN point code of the mated application or other attributes of the mated application, perform these procedures as applicable.

- To change the MRNSET and MRN point code of the mated application, perform the [Changing the MRNSET and MRN Point Code Values of MAP Entries](#) procedure.
- To change other attributes of the mated application, perform the [Changing the Attributes of a Mated Application](#) procedure.

Figure 2-119 Change the Weight and In-Service Threshold Values of a Mated Application - Sheet 1 of 8

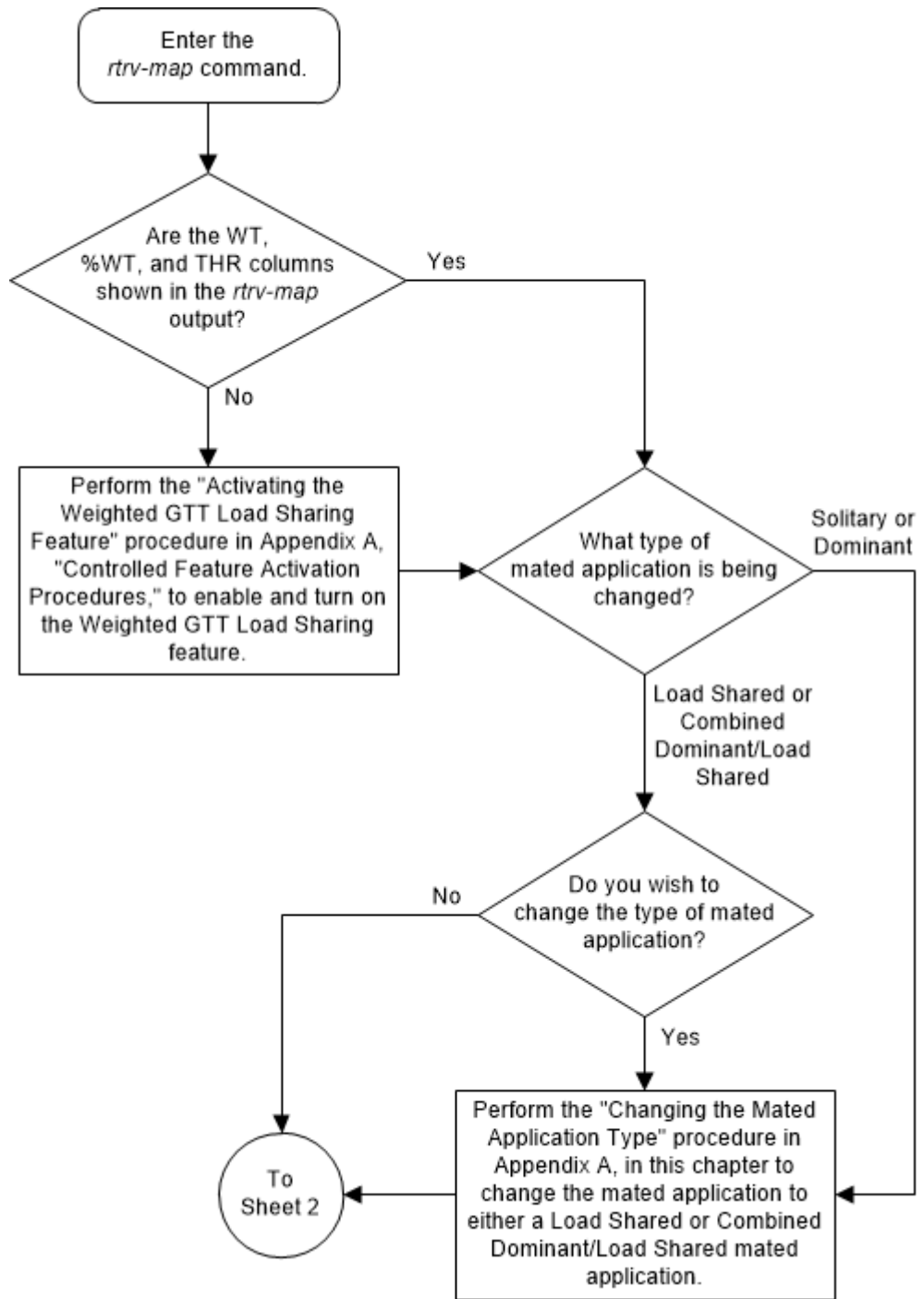

Figure 2-120 Change the Weight and In-Service Threshold Values of a Mated Application - Sheet 2 of 8

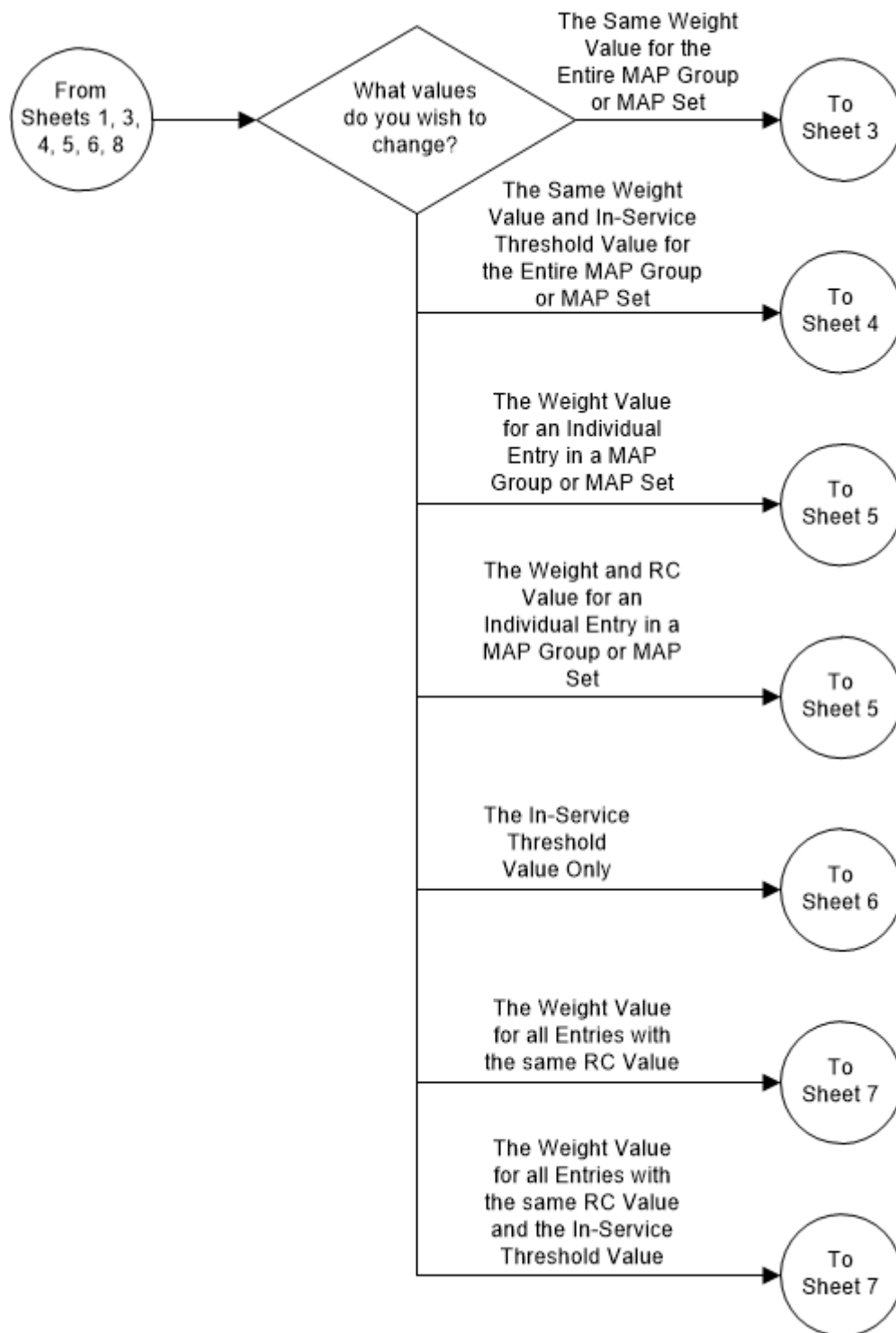

Figure 2-121 Change the Weight and In-Service Threshold Values of a Mated Application - Sheet 3 of 8

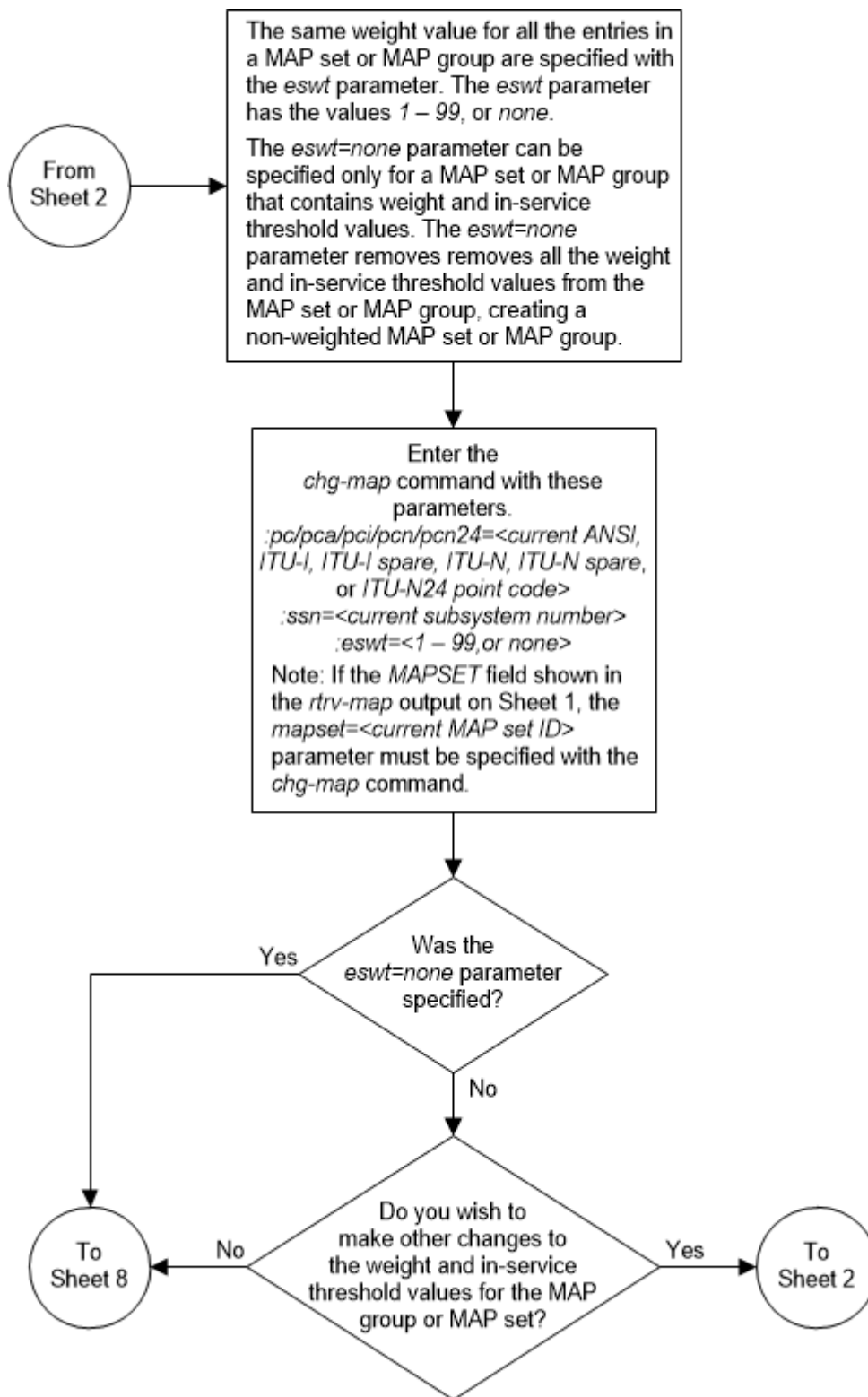

Figure 2-122 Change the Weight and In-Service Threshold Values of a Mated Application - Sheet 4 of 8

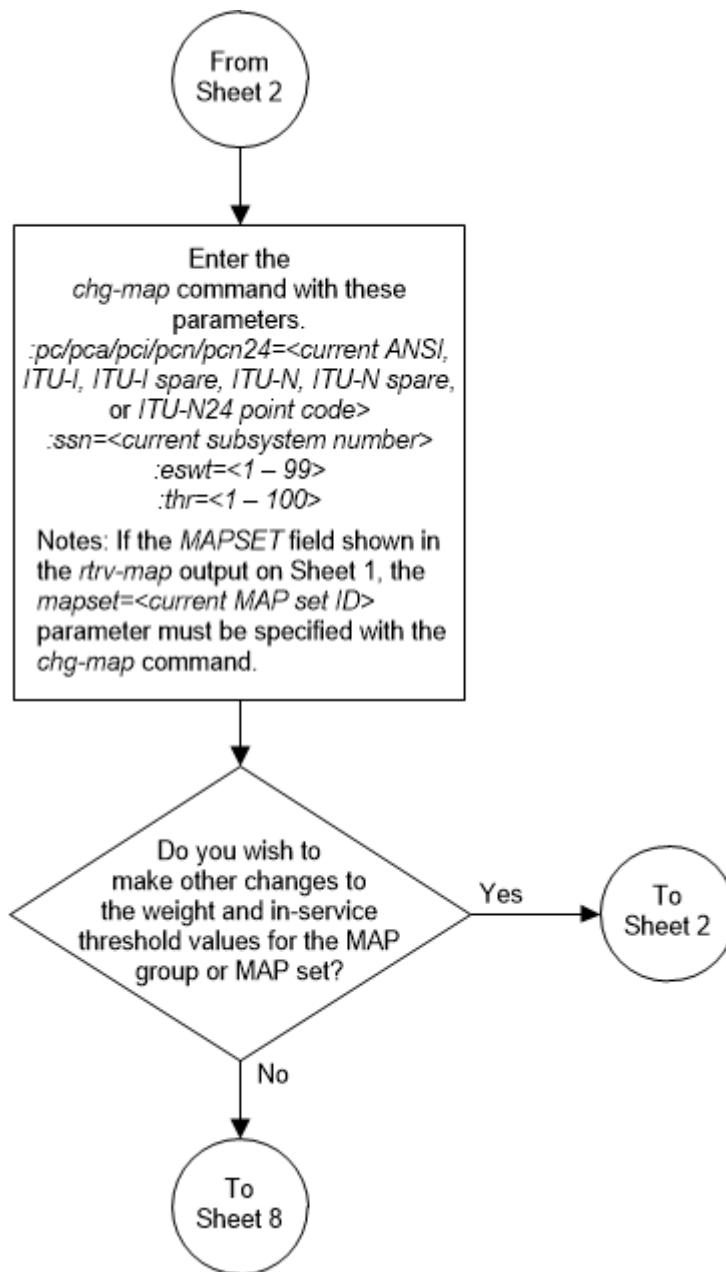

Figure 2-123 Change the Weight and In-Service Threshold Values of a Mated Application - Sheet 5 of 8

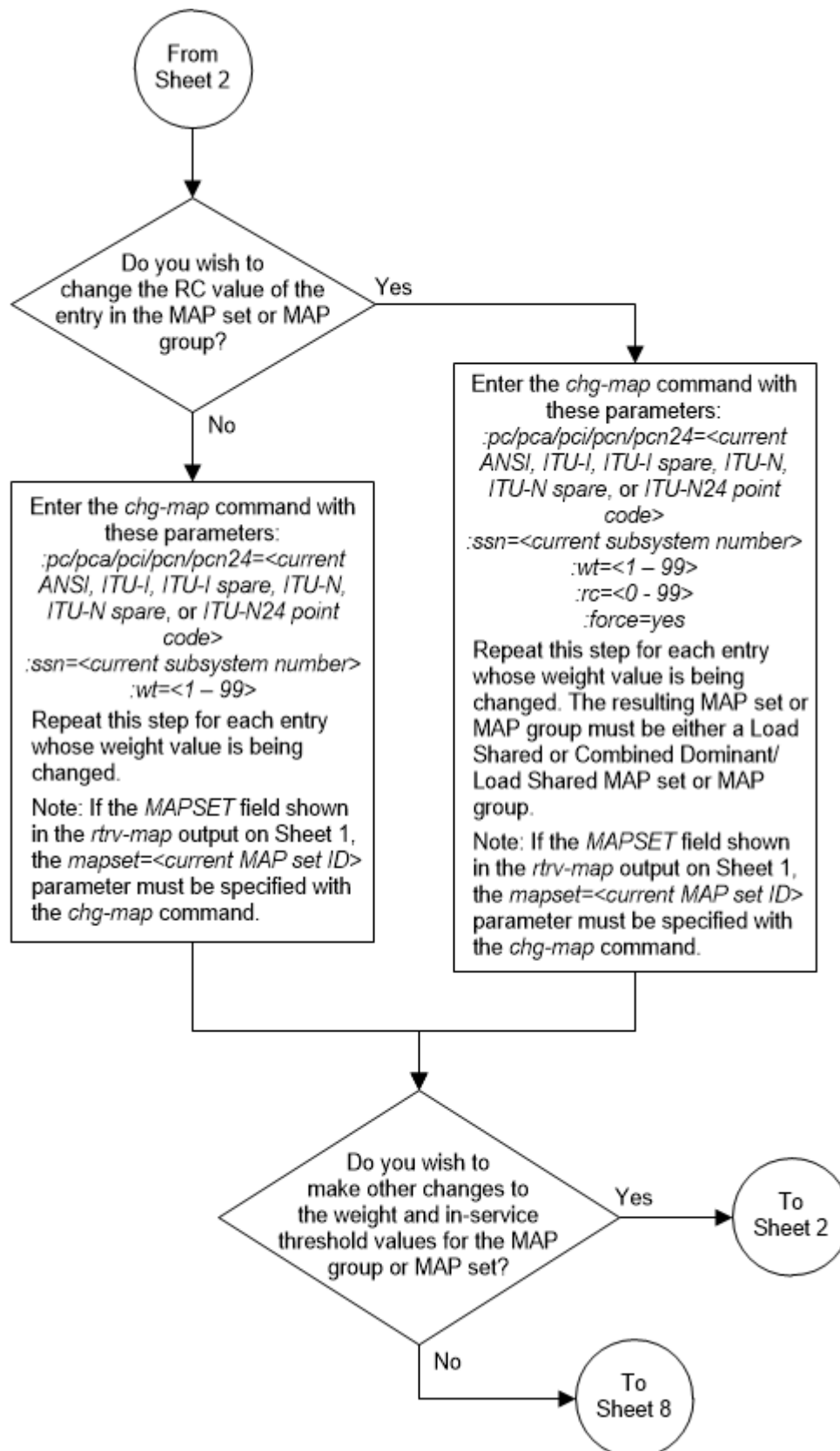

Figure 2-124 Change the Weight and In-Service Threshold Values of a Mated Application - Sheet 6 of 8

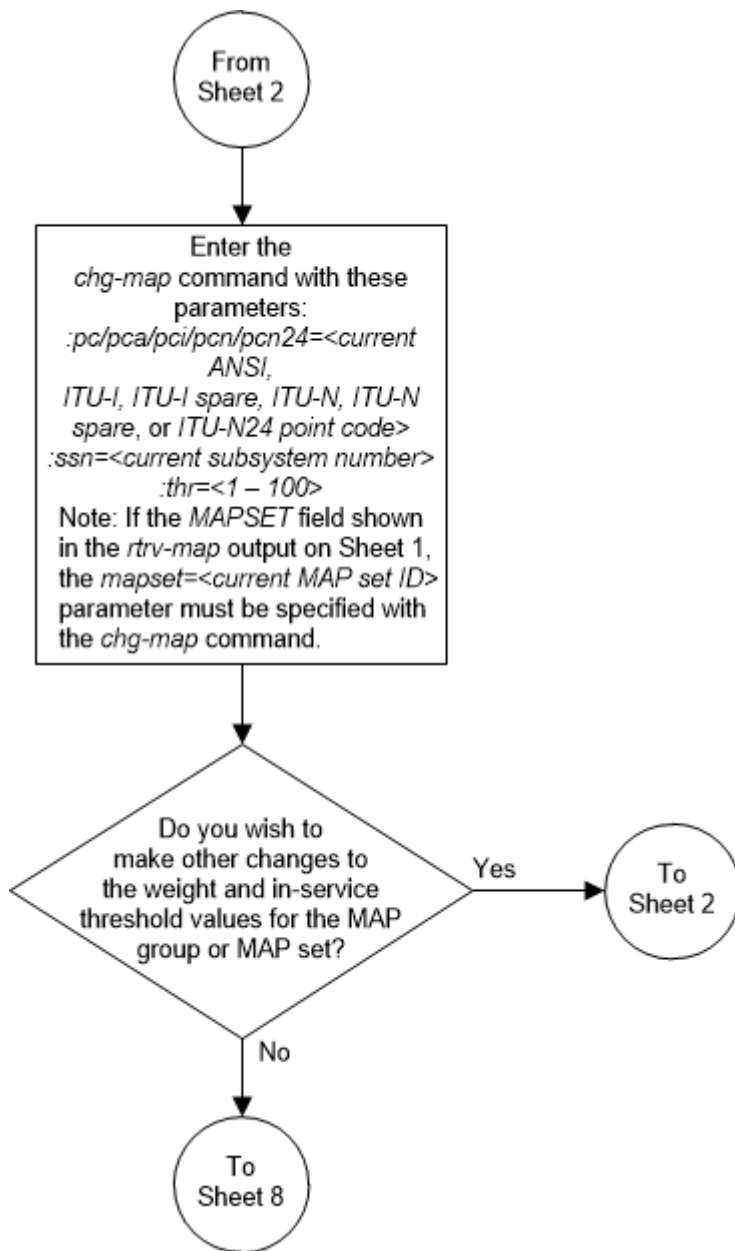

Figure 2-125 Change the Weight and In-Service Threshold Values of a Mated Application - Sheet 7 of 8

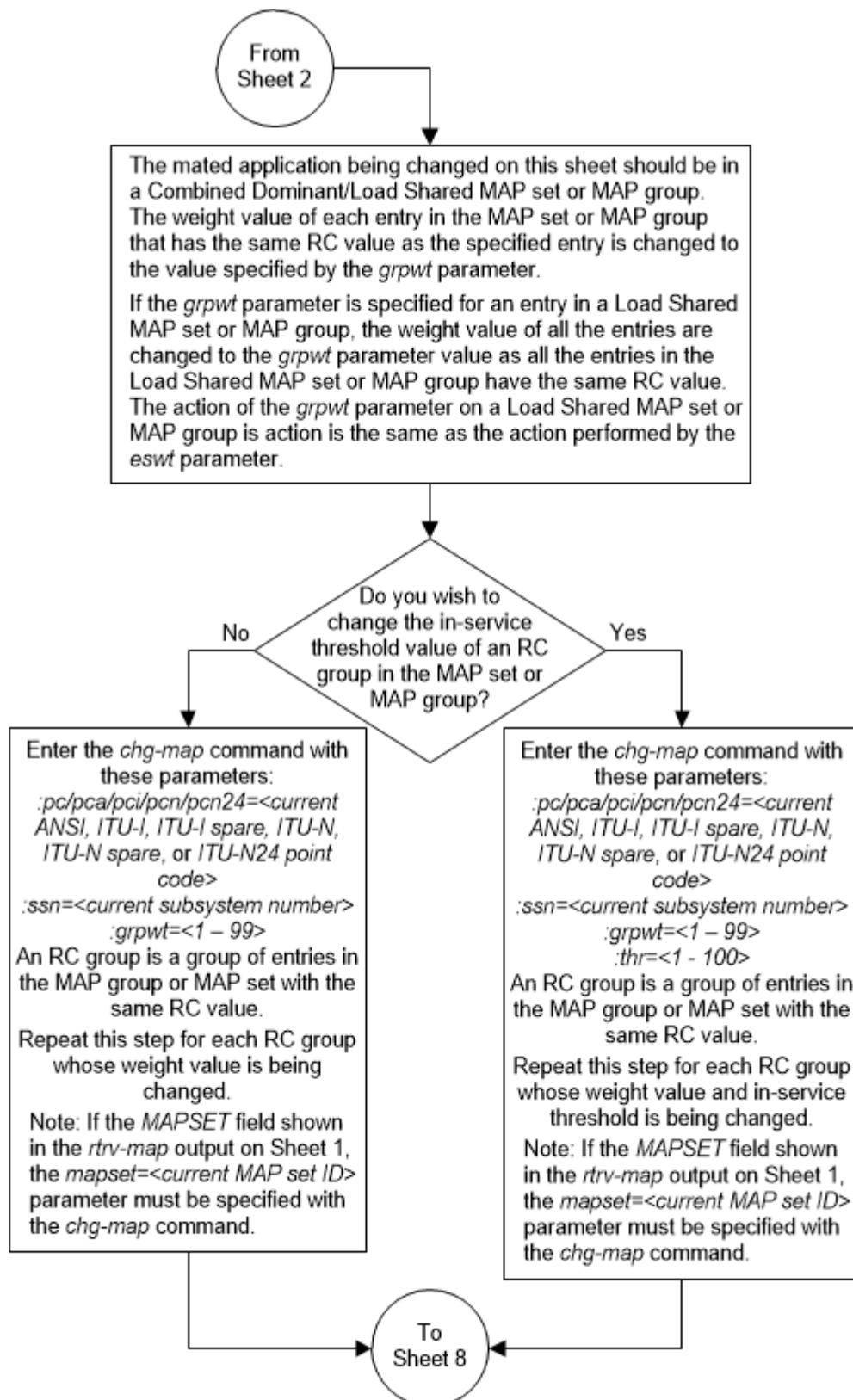
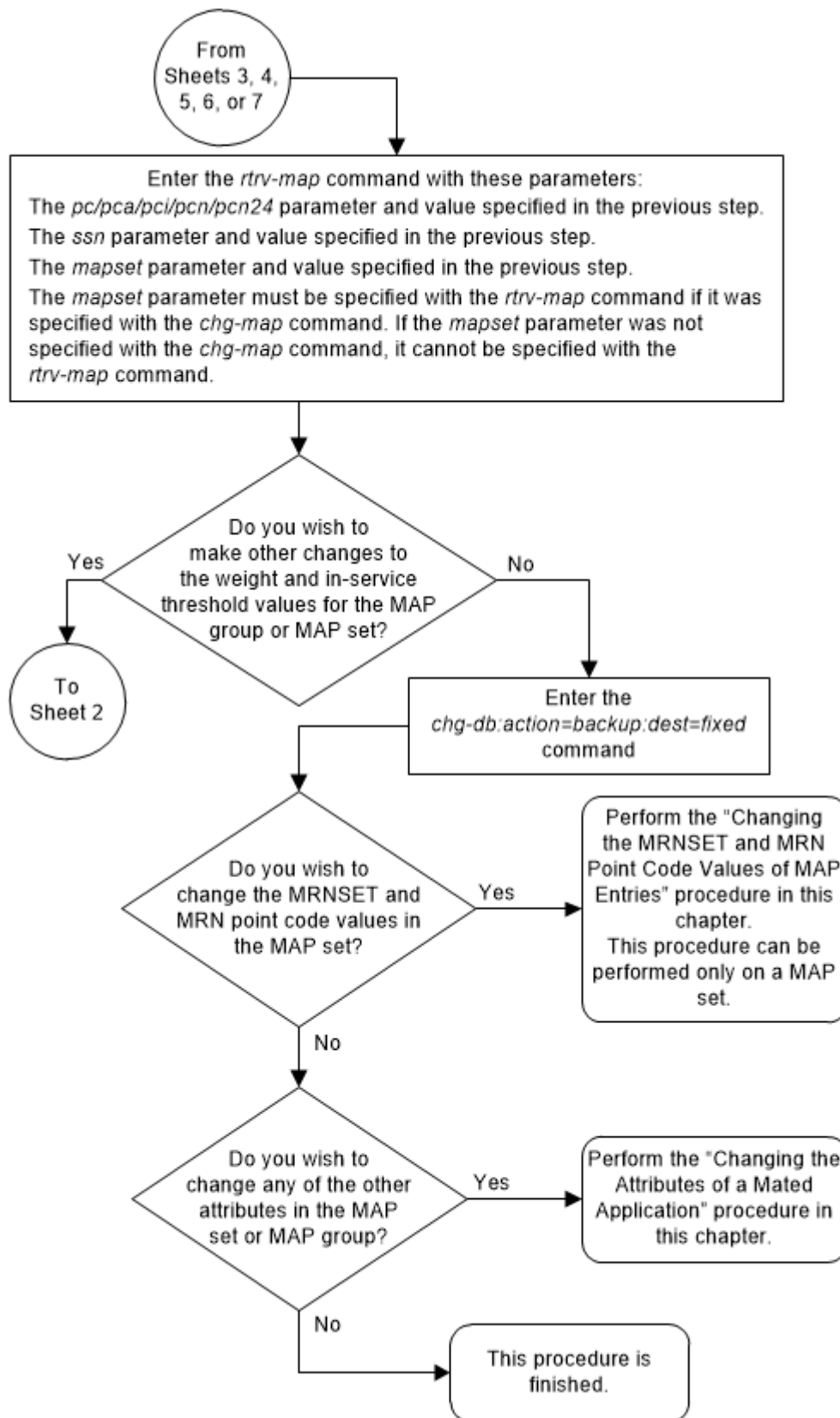

Figure 2-126 Change the Weight and In-Service Threshold Values of a Mated Application - Sheet 8 of 8



Changing the MRNSET and MRN Point Code Values of MAP Entries

This procedure is used to change the MRNSET and MRN point code values in an existing mated application (MAP) set using the `mrnset` and `mrnpc/mrnpca/mrnpci/mrnpn/mrnpn24` parameters of the `chg-map` command.

The `chg-map` command can also be used to add point code/SSN entries to an existing MAP set. This action is not covered in this procedure. If you wish to add point code/SSN entries to an existing MAP set, perform one of these procedures.

- [Provisioning a Solitary Mated Application](#)
- [Provisioning a Dominant Mated Application](#)
- [Provisioning a Load Shared Mated Application](#)
- [Provisioning a Combined Dominant/Load Shared Mated Application](#)

Parameter values other than the `mrnset` and MRN point code parameter values can be changed with the `chg-map` command. This action is not covered in this procedure. Perform these procedures as applicable to change the other parameter values.

- To change the mated application type of the mated application, perform the [Changing the Mated Application Type](#) procedure.
- To change the weights or in-service thresholds of the mated application, perform the [Changing the Weight and In-Service Threshold Values of a Mated Application](#) procedure.
- To change other attributes of the mated application, perform the [Changing the Attributes of a Mated Application](#) procedure.

These parameters are used with the `chg-map` command in this procedure.

`:mapset` – The MAP set ID that is being changed.

`:pc/pca/pci/pcn/pcn24` – The point code in the MAP set.

`:ssn` – The subsystem number assigned to the point code in the MAP set.

`:mrnset` – The MRN set ID that is being assigned to the mated application. This is the MRN set from which alternate routing indicator searches are performed.

`:mrnpc/mrnpca/mrnpci/mrnpn/mrnpn24` – The point code assigned to the `mrnset` that is being assigned to the MAP set.

Note:

Refer to Chapter 2, *Configuring Destination Tables in Database Administration - SS7 User's Guide* for a definition of the point code types that are used on the EAGLE and for a definition of the different formats that can be used for ITU national point codes.

The current values of the `mrnset` and `:mrnpc/mrnpca/mrnpci/mrnpn/mrnpn24` parameters are shown in the `rtrv-map` output only if the Flexible GTT

Load Sharing and the GTT Load Sharing with Alternate Routing Indicator features are enabled.

The new values for the `mrnset` and `mrnpc/mrnpca/mrnpai/mrnpai/mrnpai24` parameters must be shown in the `rtrv-mrn` output.

The network type of the `pc/pca/pai/pai/pai24` and `mrnpc/mrnpca/mrnpai/mrnpai/mrnpai24` parameter values must be compatible, as shown in [Table 2-54](#).

Table 2-54 MAP and MRN Point Code Parameter Combinations

MAP Point Code Parameter	MRN Point Code Parameter
<code>pc/pca</code>	<code>mrnpc/mrnpca</code>
<code>pai or pai (See Notes 1 and 2)</code>	<code>mrnpai or mrnpai (See Notes 1 and 2)</code>
<code>pai24</code>	<code>mrnpai24</code>
Notes:	
1. If the network type of the MAP point code parameter is ITU-I (<code>pai</code>), the network type of the MRN point code parameter can be either ITU-I (<code>mrnpai</code>) or ITU-N (<code>mrnpai</code>).	
2. If the network type of the MAP point code parameter is ITU-N (<code>pai</code>), the network type of the MRN point code parameter can be either ITU-I (<code>mrnpai</code>) or ITU-N (<code>mrnpai</code>).	

Canceling the `RTRV-MAP` Command

Because the `rtrv-map` command used in this procedure can output information for a long period of time, the `rtrv-map` command can be canceled and the output to the terminal stopped. There are three ways that the `rtrv-map` command can be canceled.

- Press the `F9` function key on the keyboard at the terminal where the `rtrv-map` command was entered.
- Enter the `canc-cmd` without the `trm` parameter at the terminal where the `rtrv-map` command was entered.
- Enter the `canc-cmd:trm=<xx>`, where `<xx>` is the terminal where the `rtrv-map` command was entered, from another terminal other than the terminal where the `rtrv-map` command was entered. To enter the `canc-cmd:trm=<xx>` command, the terminal must allow Security Administration commands to be entered from it and the user must be allowed to enter Security Administration commands. The terminal's permissions can be verified with the `rtrv-secu-trm` command. The user's permissions can be verified with the `rtrv-user` or `rtrv-secu-user` commands.

For more information about the `canc-cmd` command, refer to *Commands User's Guide*.

1. Display the mated applications in the database using the `rtrv-map` command. This is an example of the possible output.

```
rlghncxa03w 09-07-07 00:34:31 GMT EAGLE5 41.1.0

MAPSET ID=DFLT
PCA          Mate PCA      SSN RC MULT SRM MRC GRP NAME SSO
255-001-000          250 10  SOL *Y  *Y  grp01  ON

MAPSET ID=1
```

PCA	Mate PCA	SSN	RC	MULT	SRM	MRC	GRP	NAME	SSO
255-001-000		251	10	SHR	*Y	*Y	grp01		OFF
	253-001-002	254	10	SHR	*Y	*Y	grp01		OFF
MAPSET ID=2									
PCA	Mate PCA	SSN	RC	MULT	SRM	MRC	GRP	NAME	SSO
255-001-000		252	10	SOL	*Y	*Y	grp01		ON
MAPSET ID=DFLT									
PCA	Mate PCA	SSN	RC	MULT	SRM	MRC	GRP	NAME	SSO
255-001-000		253	10	SHR	*Y	*Y	grp01		OFF
	253-001-004	254	10	SHR	*Y	*Y	grp01		OFF
MAPSET ID=3									
PCA	Mate PCA	SSN	RC	MULT	SRM	MRC	GRP	NAME	SSO
255-001-001		255	10	DOM	YES	YES	grp01		ON
	253-001-005	254	20	DOM	YES	YES	grp01		ON
MAPSET ID=4									
PCA	Mate PCA	SSN	RC	MULT	SRM	MRC	GRP	NAME	SSO
255-001-001		250	10	DOM	YES	YES	grp01		OFF
	253-001-001	254	20	DOM	YES	YES	grp01		OFF
MAPSET ID=DFLT									
PCA	Mate PCA	SSN	RC	MULT	SRM	MRC	GRP	NAME	SSO
255-001-002		251	10	SHR	*Y	*Y	grp01		OFF
	255-001-002	254	10	SHR	*Y	*Y	grp01		OFF
MAPSET ID=5									
PCA	Mate PCA	SSN	RC	MULT	SRM	MRC	GRP	NAME	SSO
255-001-002		252	10	DOM	YES	YES	grp01		ON
	255-001-003	254	20	DOM	YES	YES	grp01		ON
MAPSET ID=6									
PCA	Mate PCA	SSN	RC	MULT	SRM	MRC	GRP	NAME	SSO
255-001-002		253	10	SHR	*Y	*Y	grp01		ON
	255-001-004	254	10	SHR	*Y	*Y	grp01		ON
MAPSET ID=7									
PCA	Mate PCA	SSN	RC	MULT	SRM	MRC	GRP	NAME	SSO
002-002-007		50	10	COM	YES	*Y	grp01		OFF
	002-002-008	30	10	COM	YES	*Y	grp01		OFF
	002-002-009	30	10	COM	YES	*Y	grp01		OFF
	002-002-010	30	20	COM	YES	*Y	grp01		OFF
	002-002-011	30	20	COM	YES	*Y	grp01		OFF
MAPSET ID=8									
PCI	Mate PCI	SSN	RC	MULT	SRM	MRC	GRP	NAME	SSO
2-001-2		255	10	DOM	NO	YES	grp03		OFF
	2-001-1	254	20	DOM	NO	YES	grp03		OFF
MAPSET ID=9									
PCN	Mate PCN	SSN	RC	MULT	SRM	MRC	GRP	NAME	SSO
00347		253	10	SHR	*N	*N	grp05		OFF
	01387	254	10	SHR	*N	*N	grp05		OFF

```
MAP TABLE IS (20 of 36000) 1 % FULL
```

 **Note:**

If the Weighted GTT Load Sharing feature is enabled and turned on, the WT, %WT, and THR columns are shown in the `rtrv-map` output.

If the MRNSET and MRNPC columns are not shown in the `rtrv-map` output, the GTT Load Sharing with Alternate Routing Indicator feature is not enabled. Perform [Activating the GTT Load Sharing with Alternate Routing Indicator Feature](#) to enable the GTT Load Sharing with Alternate Routing Indicator feature. After [Activating the GTT Load Sharing with Alternate Routing Indicator Feature](#) has been performed, continue the procedure with 2.

If the MRNSET and MRNPC columns are shown in the `rtrv-map` output, the GTT Load Sharing with Alternate Routing Indicator feature is enabled. Continue the procedure with 2.

2. The MRN point code value must be assigned to an MRN set. The MRN set must be shown in the `rtrv-mrn` output. Display the MRN sets by entering the `rtrv-mrn` command. This is an example of the possible output.

```
rlghncxa03w 09-02-07 00:34:31 GMT EAGLE5 40.1.0
```

MRNSET	PC	RC
DFLT	005-005-005	10
	006-001-001	20
	006-001-002	30
	006-001-003	40
	006-001-004	50
	006-001-005	60
	006-001-006	70
	006-001-007	80

MRNSET	PC	RC
1	007-007-007	10
	008-001-001	20
	008-001-002	30
	008-001-003	40
	008-001-004	50
	008-001-005	60
	008-001-006	70

```
MRN table is (15 of 5990) 1% full
```

 **Note:**

If the Weighted GTT Load Sharing feature is enabled and turned on, the WT, %WT, and THR columns are shown in the `rtrv-mrn` output.

If the MRN set that you wish to use, containing the desired point code and subsystem number, is shown in the `rtrv-mrn` output, continue the procedure with [3](#).

 **Note:**

The network type of the `pc/pca/pci/pcn/pcn24` and `mrnpc/mrnpca/mrnpai/mrnpai24` parameter values must be the same, as shown in [Table 2-54](#).

If the MRN set that you wish to use is not shown in the `rtrv-mrn` output, add the required MRN set by performing [Provisioning MRN Entries](#).

After the MRN set has been added, continue the procedure with [3](#).

3. Change the MRNSET and MRN point code values in the MAP set by entering the `chg-map` command with the `mrnset` and `mrnpc/mrnpca/mrnpai/mrnpai24` parameters.

For this example, enter this command.

```
chg-
map:mapset=7:pca=002-002-007:ssn=50:mrnset=1:mrnpca=007-007-0
07
```

When the `chg-map` command has successfully completed, this message should appear.

```
rlghncxa03w 09-02-07 11:44:13 GMT EAGLE5 40.1.0
CHG-MAP: MASP A - COMPLTD
```

4. Verify the changes using the `rtrv-map` command with the point code (`pca/pci/pcn/pcn24`), `ssn`, and `mapset` values specified in [3](#).

For this example, enter this command.

```
rtrv-map:mapset=7:pca=002-002-007:ssn=50
```

This is an example of the possible output.

```
rlghncxa03w 09-07-07 00:34:31 GMT EAGLE5 41.1.0

MAPSET ID=7      MRNSET ID=1      MRNPC   =   007-007-007
PCA              Mate PCA          SSN RC  MULT SRM  MRC  GRP  NAME  SSO
002-002-007      50 10  COM  YES *Y  grp01  OFF
                  002-002-008      30 10  COM  YES *Y  grp01  OFF
                  002-002-009      30 10  COM  YES *Y  grp01  OFF
                  002-002-010      30 20  COM  YES *Y  grp01  OFF
                  002-002-011      30 20  COM  YES *Y  grp01  OFF

MAP TABLE IS (20 of 36000) 1 % FULL
```

 **Note:**

If the Weighted GTT Load Sharing feature is enabled and turned on, the WT, %WT, and THR columns are shown in the `rtrv-map` output.

5. Backup the new changes using the `chg-db:action=backup:dest=fixed` command. These messages should appear, the active Maintenance and Administration Subsystem Processor (MASP) appears first.

```
BACKUP (FIXED) : MASP A - Backup starts on active MASP.  
BACKUP (FIXED) : MASP A - Backup on active MASP to fixed disk  
complete.  
BACKUP (FIXED) : MASP A - Backup starts on standby MASP.  
BACKUP (FIXED) : MASP A - Backup on standby MASP to fixed disk  
complete.
```

If you do not wish to change the mated application type, the weights or in-service thresholds of the mated application, or other attributes of the mated application, this procedure is finished.

If you wish to change the mated application type, the weights or in-service thresholds of the mated application, or other attributes of the mated application, perform these procedures as applicable.

- To change the mated application type of the mated application, perform the [Changing the Mated Application Type](#) procedure.
- To change the weights or in-service thresholds of the mated application, perform the [Changing the Weight and In-Service Threshold Values of a Mated Application](#) procedure.
- To change other attributes of the mated application, perform the [Changing the Attributes of a Mated Application](#) procedure.

Figure 2-127 Change the MRNSET and MRN Point Code Values of MAP Entries
- Sheet 1 of 3

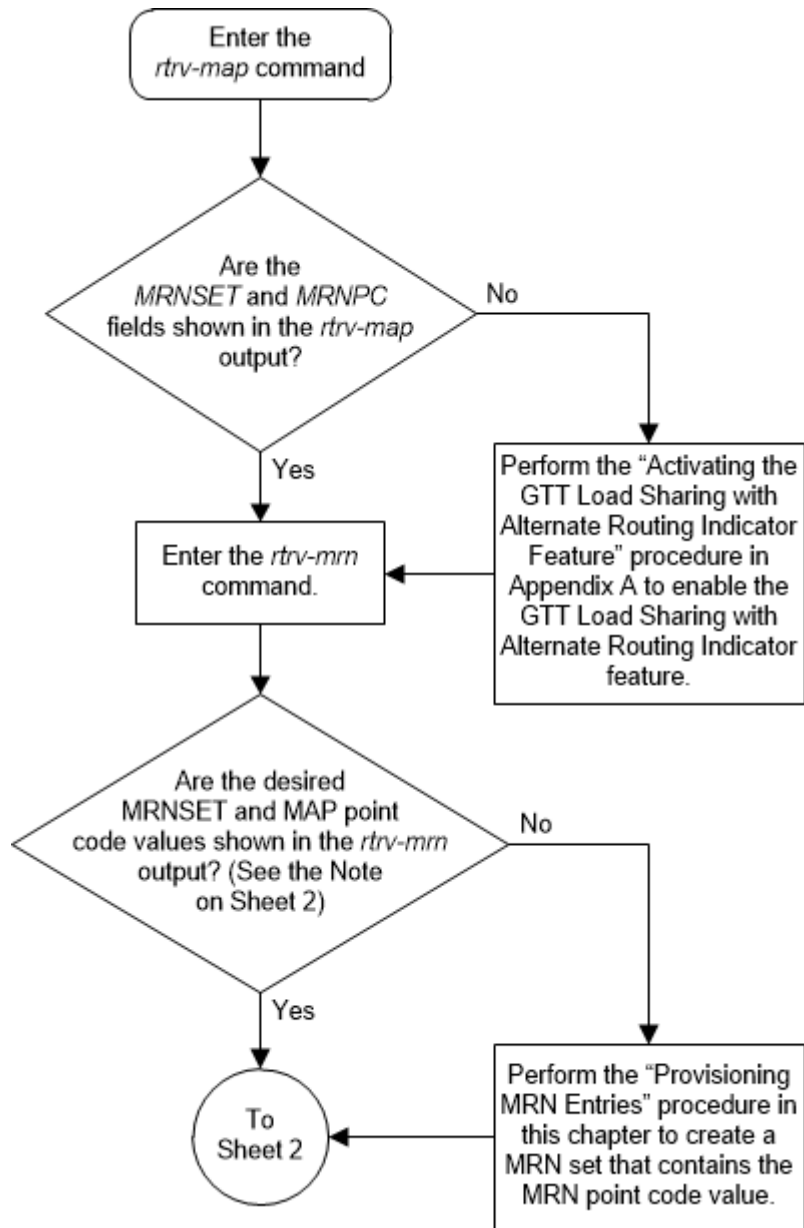

Figure 2-128 Change the MRNSET and MRN Point Code Values of MAP Entries
- Sheet 2 of 3

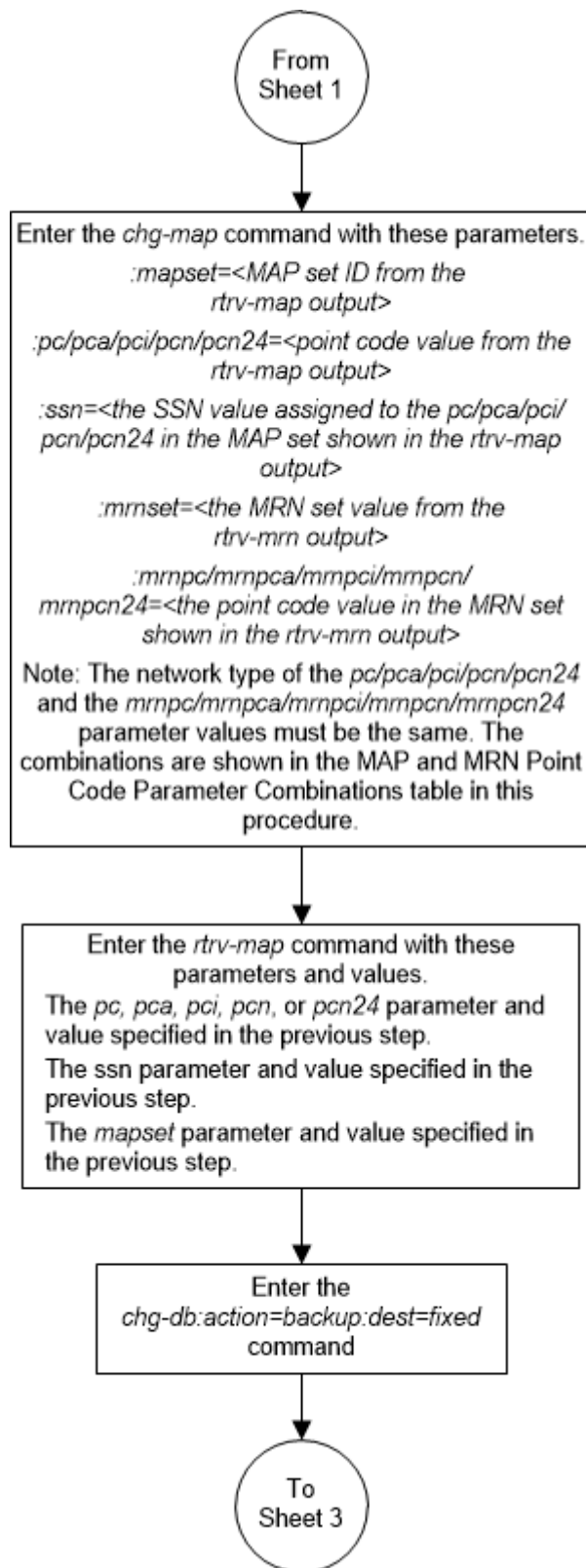
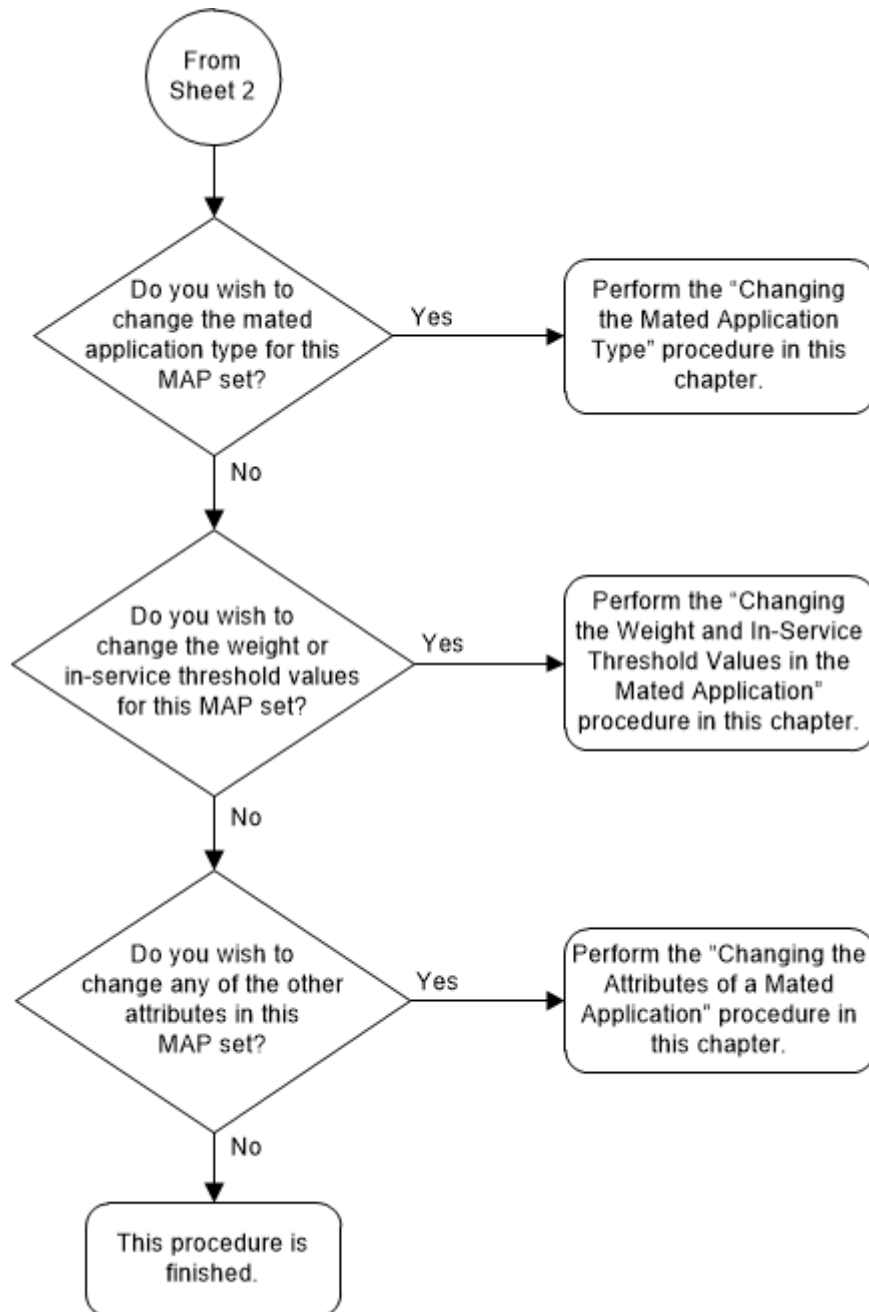

Figure 2-129 Change the MRNSET and MRN Point Code Values of MAP Entries
- Sheet 3 of 3



Provisioning MRN Entries

This procedure is used to provision an Mated Relay Node (MRN) group or MRN set in the database or to add a point code to an existing MRN group or MRN set for the Intermediate Global Title Load Sharing feature using the `ent-mrn` and `chg-mrn` commands.

An MRN group or MRN set contains alternate point codes, up to 128, that are used for load sharing between multiple nodes when the EAGLE is performing intermediate global title translation. This load sharing is performed after intermediate global title translation is performed on the message. The point code in the message is changed to the selected point code in the MRN table. If the translated point code is not found in the MRN table, the translated point code in the message is not changed, the message is routed using route for the translated point code.

The `ent-mrn` and `chg-mrn` command uses these parameters.

`:pc/pca/pci/pcn/pcn24` – The point code in the message after intermediate global title translation has been performed.

`:rc` – The relative cost value of point code in the message

`:pc1/pca1/pci1/pcn1/pcn241` – The first alternate point code value

`:rc1` – The relative cost value of the first alternate point code

`:pc2/pca2/pci2/pcn2/pcn242` – The second alternate point code value

`:rc2` – The relative cost value of the second alternate point code

`:pc3/pca3/pci3/pcn3/pcn243` – The third alternate point code value

`:rc3` – The relative cost value of the third alternate point code

`:pc4/pca4/pci4/pcn4/pcn244` – The fourth alternate point code value

`:rc4` – The relative cost value of the fourth alternate point code

 **Note:**

Refer to Chapter 2, *Configuring Destination Tables in Database Administration - SS7 User's Guide* for a definition of the point code types that are used on the EAGLE and for a definition of the different formats that can be used for ITU national point codes.

`:mrnset` – The MRN set ID that the point codes are assigned to. This parameter can be specified only, and must be specified, if the Flexible GTT Load Sharing feature is enabled. If the Flexible GTT Load Sharing feature is enabled, the point code specified for the global title translation must be assigned to the MRN set specified by this parameter. The status of the Flexible GTT Load Sharing feature is shown in the `rtrv-ctrl-feat` output. To enable the Flexible GTT Load Sharing feature, perform [Activating the Flexible GTT Load Sharing Feature](#).

The MRN set ID has one of three values:

- `df1t` – to assign the MRN to the default MRN set.
- `new` – to assign the MRN to a new MRN set. This value can be specified only with the `ent-mrn` command.
- the specific number of an existing MRN set if you are assigning the point codes to an existing MRN set.
Refer to [Provisioning an MRN Set](#) for information on provisioning MRN sets.

`:df1twt` – The default weight value. When this parameter is specified, the same weight value is assigned to all entries specified in the `ent-mrn` command. The value of this parameter is from 1 - 99. This parameter can be specified only with the `ent-mrn` command.

`:wt` – The weight value assigned to the `pc/pca/pci/pcn/pcn24` parameter value. The value of this parameter is from 1 - 99.

`:wt1` – The weight value assigned to the `pc1/pca1/pci1/pcn1/pcn241` parameter value. The value of this parameter is from 1 - 99.

`:wt2` – The weight value assigned to the `pc2/pca2/pci2/pcn2/pcn242` parameter value. The value of this parameter is from 1 - 99.

`:wt3` – The weight value assigned to the `pc3/pca3/pci3/pcn3/pcn243` parameter value. The value of this parameter is from 1 - 99.

`:wt4` – The weight value assigned to the `pc4/pca4/pci4/pcn4/pcn244` parameter value.

`:thr` – The in-service threshold assigned to the MRN group or MRN set. The in-service threshold is the minimum percentage (from 1 - 100) of weight that must be available for an RC group (a group of entries in the MRN group or MRN set that have the same RC value assigned) to be considered available to carry traffic. If the percentage of the available weight is less than the in-service threshold, then the entire RC group is considered unavailable for traffic. If the percentage of the available weight is equal to or greater than the in-service threshold, then the RC group is considered available, and traffic can be sent to any available entity in the RC group. The value of the `thr` parameter is assigned to all entries in the MRN group or MRN set that have the same RC value that is specified in the `ent-mrn` command. The `thr` parameter can be used in this procedure only with the `ent-mrn` command.

Refer to [Provisioning Weights and In-Service Thresholds for MRNs](#) for information on provisioning MRN groups or MRN sets with weight and in-service threshold values.

The following parameters of the `chg-mrn` command cannot be used in this procedure: `thr`, `grpwt`, `eswt`, and `force=yes`. These parameters can be used with the `chg-mrn` command only when changing the attributes of specific entries in an existing MRN group or MRN set, and not when adding entries to an existing MRN group or MRN set. If you wish to change specific entries in an existing MRN group or MRN set, perform either [Changing MRN Entries with the ESWT Parameter](#) or [Changing the Weight and Threshold Values of MRN Entries](#).

`:mapset` – The MAP set ID that is being assigned to the MRN. This is the MAP set from which alternate routing indicator searches are performed.

`:mappc/mappca/mappci/mappcn/mappcn24` – The point code assigned to the `mapset` that is being assigned to the MRN set.

`:mapssn` – The subsystem number assigned to the point code in the MAP set that is being assigned to the MRN.

The current values of the `mapset`, `mappc/mappca/mappci/mappcn/mappcn24`, and `mapssn` parameters are shown in the `rtrv-mrn` output only if the Flexible GTT Load Sharing and the GTT Load Sharing with Alternate Routing Indicator features are enabled.

The new values for the `mapset`, `mappc/mappca/mappci/mappcn/mappcn24`, and `mapssn` parameters must be shown in the `rtrv-map` output. If no values

are specified for the `mapset`, `mappc/mappca/mappci/mappcn/mappcn24`, and `mapssn` parameters when the `ent-mrn` command is entered, then no values for these parameters are assigned to the MRN set. If no values are specified for the `mapset`, `mappc/mappca/mappci/mappcn/mappcn24`, and `mapssn` parameters when the `chg-mrn` command is entered, then the values for these parameters in the MRN set are not changed.

To add a new MRN group, the group must be provisioned in the database with the `ent-mrn` command, specifying up to four alternate point codes. If more point codes are to be added to the MRN group, either the `ent-mrn` or `chg-mrn` command to add the additional point codes to the MRN group. A maximum of 128 point codes can be assigned to an MRN group. If the Flexible GTT Load Sharing feature is enabled, refer to [Provisioning an MRN Set](#) for information on provisioning MRN sets.

A point code and `rc` value must be entered as a pair. For example, the `pc3` and `rc3` parameters must be specified together in the `ent-mrn` or `chg-mrn` commands if the alternate point code value is being specified.

The point codes specified with the `ent-mrn` or `chg-mrn` commands can be in only one MRN group. If the Flexible GTT Load Sharing feature is enabled, refer to [Provisioning an MRN Set](#) for information on provisioning point codes in MRN sets.

The relative cost parameters (`rc/rc1/rc2/rc3/rc4`) determine how the global title translation load is to be shared among the alternate point codes. There are three types of load sharing that can be performed: dominant, load shared, or combined dominant/load shared.

All the point codes in a dominant MRN group or MRN set have different relative cost values. The translated point code in the message is the preferred point code that the message is routed on. The relative cost value assigned to the preferred point code does not have to be the lowest value in the MRN group or MRN set. All traffic is routed to the preferred point code, if it is available. If the preferred point code becomes unavailable, the traffic is routed to highest priority alternate point code that is available. When the preferred point code becomes available again, the traffic is then routed back to the preferred point code. For example, the MRN table contains the following entries.

PC	RC
005-005-005	10
006-001-001	20
006-001-002	30
006-001-003	40
006-001-004	50
006-001-005	60
006-001-006	70
006-001-007	80

If the preferred point code is 006-001-001 and it becomes unavailable, the traffic will be routed to point code 006-001-002.

All the point codes in a load shared MRN group or MRN set have the same relative cost value. Traffic is shared equally between the point codes in this MRN group or MRN set.

A combined dominant/load shared MRN group or MRN set is a combination of the dominant and load sharing MRN groups or MRN sets. A combined dominant/load shared MRN group or MRN set must contain a minimum of two entries with the same

relative cost value and a minimum of one entry with a different relative cost value. Traffic is routed to the point code or point codes with the lowest relative cost value, where the relative cost value is considered the relative cost associated with the point code of the global title translation and not the actual lowest relative cost in the MRN set. If more than one point code has the lowest relative cost value, the traffic is shared between these point codes. If the point code or point codes with the lowest relative cost value become unavailable, traffic is routed to the point code or point codes with the next higher relative cost value. If more than one point code has this relative cost value, the traffic is shared between these point codes. For example, the MRN table contains the following entries.

PC	RC
005-005-005	10
006-001-001	10
006-001-002	10
006-001-003	20
006-001-004	20
006-001-005	20
006-001-006	20
006-001-007	20

If the preferred point code is 006-001-001, the traffic is shared equally between point codes 005-005-005, 006-001-001, and 006-001-002. If point codes 005-005-005, 006-001-001, and 006-001-002 become unavailable, the traffic will be shared equally between point codes, 006-001-003, 006-001-004, 006-001-005, 006-001-006, and 006-001-007.

The point codes in the MRN group or MRN set must be a full point code with a route assigned to it. Cluster point codes, network routing point codes, or the EAGLE's true point code cannot be specified in an MRN group or MRN set. The `rtrv-rte` command can be used to verify the point codes in the routing table. The point codes in the routing table are shown in the `DPCA`, `DPCI`, `DPCN`, or `DPCN24` fields of the `rtrv-rte` command output. The EAGLE's true point code is shown in the `PCA`, `PCI`, `PCN`, or `PCN24` fields of the `rtrv-sid` command output.

The Intermediate GTT Load Sharing controlled feature must be enabled and activated before an MRN group can be provisioned in the database. This can be verified with the `rtrv-ctrl-feat` command. If this controlled feature is enabled and activated, the Intermediate GTT Load Sharing feature is shown as either temporarily or permanently enabled in the `rtrv-ctrl-feat` output, and the entry `on` is shown in the `Status` column for this feature. If this controlled feature is off, perform [Activating the IGTTLS feature](#) to enable and turn on this feature.

For MRNs containing ANSI or 24-bit ITU-N point codes, the format of the point codes specified in the `ent-mrn` command must be the same. For example, if the primary point code is a 24-bit ITU-N point code (`pcn24`), the alternate point code must be a 24-bit ITU-N point code (`mpcn24`). The alternate point codes of MRNs containing either ITU-I, ITU-I spare, 14-bit ITU-N, or 14-bit ITU-N spare primary point codes do not have to be the same format as the primary point code. The alternate point codes of these MRNs can be a mixture of ITU-I, ITU-I spare, 14-bit ITU-N, or 14-bit ITU-N spare point codes.

If only the Intermediate GTT Load Sharing feature is enabled and turned on, the MRN table can contain a maximum of 3000 entries. If the Flexible GTT Load Sharing feature is enabled, the MRN table can contain a maximum of 6000 entries. If entries

are provisioned in the SCCP-SERV table, shown by the `rtrv-sccp-serv` command output, the maximum number of entries that the MRN table can contain is reduced by the number of entries shown in the `rtrv-sccp-serv` command output.

If adding the new MRN entries will exceed the maximum capacity of the MRN table, shown in the `rtrv-mrn` command output, entries in the MRN or SCCP-SERV tables must be removed so that the new MRN entries can be added. Perform [Removing MRN Entries](#) to remove the required number of MRN entries to allow the addition of the new MRN entries or enter the `dlt-sccp-serv` command to remove the required number of entries in the SCCP-SERV table to allow the addition of the new MRN entries.

Provisioning an MRN Set

The Flexible GTT Load Sharing feature provides the ability to define multiple load sharing sets in the MRN table where the same point code can be assigned to different load sharing sets.

The MRN table contains specific load sharing sets, designated by numbers, and a default MRN set.

The MRN table without the Flexible GTT Load Sharing feature enabled, is used by MPS based features and all global title translation features.

The Flexible GTT Load Sharing feature provides flexible load sharing for global title translations defined in the GTT table and not for the MPS based features. The MPS based features do not support the MRN set ID parameter. The MPS based features perform lookups for load sharing in the default MRN set and the GTT table. The entries in the GTT table can be linked to an MRN set ID, allowing lookups in a specific MRN set other than the default MRN set.

Any MRN entries that were provisioned in the database before the Flexible GTT Load Sharing feature is enabled are placed in the default MRN set when the Flexible GTT Load Sharing feature is enabled.

Any GTT entries that were provisioned in the database before the Flexible GTT Load Sharing feature is enabled are assigned to the default MRN set when the Flexible GTT Load Sharing feature is enabled.

If the Flexible GTT Load Sharing is enabled, the `mrnset` parameter must be specified with the `ent-mrn` or `chg-mrn` commands.

To provision entries in the default MRN set, the `mrnset=dflt` parameter must be specified with the `ent-mrn` or `chg-mrn` commands.

To provision entries in an existing MRN set other than the default MRN set, the `mrnset=<MRN set ID>` parameter must be specified with the `ent-mrn` or `chg-mrn` commands. The `rc` parameter value for this point code should not be specified. If the `rc` parameter is specified, an attempt will be made to provision another MRN group in this MRN set. Multiple MRN groups in one MRN set is supported only in the default MRN set. The new entries to this MRN set must be specified with the alternate point code parameters and their corresponding `rc` parameters.

To provision entries in a new MRN set, the `mrnset=new` parameter must be specified with the `ent-mrn` command. The `mrnset=new` parameter can be specified only with the `ent-mrn` command. When the `ent-mrn` command is executed with

the `mrnset=new` parameter, the new MRN set ID is automatically generated and displayed in the output of the `ent-mrn` command as follows.

```
New MRNSET Created : MRNSETID = <new MRN set ID>
```

An MRN set, other than the default MRN set, is an MRN group provisioned with the MRN set ID and can contain a maximum of 128 point codes.

The default MRN set can contain multiple MRN groups. Each group in the default MRN set can contain a maximum of 128 point codes. The point code value can appear only once in the default MRN set, so the point code value can appear in only one MRN group in the default MRN set.

The point code provisioned in an MRN set can be provisioned in multiple MRN sets. All the point codes in an MRN set must be different.

Provisioning Weights and In-Service Thresholds for MRN Entries

Weighted GTT Load Sharing allows unequal traffic loads to be provisioned in load sharing groups. This feature also allows provisioning control over load sharing groups so that if insufficient capacity within the load sharing group is available, the load sharing group is not used.

To provision the weight values and in-service threshold values for new MRN groups or MRN sets or new entries in existing MRN groups or MRN sets, the `df1twt`, `wt`, `wt1`, `wt2`, `wt3`, `wt4`, and `thr` parameters are used.

The `df1twt`, `wt`, `wt1`, `wt2`, `wt3`, `wt4`, and `thr` parameters can be used only:

- If the MRN group or MRN set is either a load shared or combined dominant/load shared MRN group or MRN set.
- If the Weighted GTT Load Sharing feature is enabled and turned on.

The status of the Weighted GTT Load Sharing feature can be verified by entering the `rtrv-ctrl-feat` command. If the Weighted GTT Load Sharing feature is not enabled or not turned on, perform [Activating the Weighted GTT Load Sharing Feature](#) to enable and turn on the Weighted GTT Load Sharing feature.

To assign the same weight value to all the entries specified in the `ent-mrn` command, use the `df1twt` parameter.

To assign an in-service threshold value to all the entries specified in the `ent-mrn` command, use the `thr` parameter.

To assign different weight values to the entries specified in either the `ent-mrn` or `chg-mrn` commands, use the `wt`, `wt1`, `wt2`, `wt3`, and `wt4` parameters with the corresponding point code parameters.

The `df1twt` parameter and the individual weight parameters (`wt`, `wt1`, `wt2`, `wt3`, `wt4` parameters) cannot be specified together in the `ent-mrn` command.

The `thr` parameter cannot be specified in this procedure with the `chg-mrn` command. Specifying the `thr` parameter with the `chg-mrn` command can be done when specifying only the `pc/pca/pci/pcn/pcn24` parameter and without the alternate point code parameters. To specify the `thr` parameter with the `chg-mrn` command, perform either [Changing MRN Entries with the ESWT Parameter](#) or [Changing the Weight and Threshold Values of MRN Entries](#).

The weight values assigned to the entries in the MRN group or MRN set are shown in the WT column in the `rtrv-mrn` output.

The in-service threshold values assigned to the entries in the MRN group or MRN set are shown in the THR column in the `rtrv-mrn` output.

The %WT column in the `rtrv-mrn` output shows the percentage of the traffic the particular entry in the entity set will handle.

The WT, %WT, and THR columns are shown in the `rtrv-mrn` output only if the Weighted GTT Load Sharing feature is enabled and turned on.

For more information on the Weighted GTT Load Sharing feature, refer to the [Weighted GTT Load Sharing](#) section.

Canceling the RTRV-MRN Command

Because the `rtrv-mrn` command used in this procedure can output information for a long period of time, the `rtrv-mrn` command can be canceled and the output to the terminal stopped. There are three ways that the `rtrv-mrn` command can be canceled.

- Press the F9 function key on the keyboard at the terminal where the `rtrv-mrn` command was entered.
- Enter the `canc-cmd` without the `trm` parameter at the terminal where the `rtrv-mrn` command was entered.
- Enter the `canc-cmd:trm=<xx>`, where `<xx>` is the terminal where the `rtrv-mrn` command was entered, from another terminal other than the terminal where the `rtrv-mrn` command was entered. To enter the `canc-cmd:trm=<xx>` command, the terminal must allow Security Administration commands to be entered from it and the user must be allowed to enter Security Administration commands. The terminal's permissions can be verified with the `rtrv-secu-trm` command. The user's permissions can be verified with the `rtrv-user` or `rtrv-secu-user` commands.

For more information about the `canc-cmd` command, refer to *Commands User's Guide*.

1. Display the mated relay node groups in the database using the `rtrv-mrn` command.

This is an example of the possible output if the Flexible GTT Load Sharing feature is not enabled.

```
rlghncxa03w 09-02-07 00:34:31 GMT EAGLE5 40.1.0

      MRNSET MAPSET  MAPPCC          MAPSSN      PC          RC WT
%WT THR
  DFLT  -----  -----          ---      007-007-007  10 10
14    1
                                     008-001-001  10 10
14    1
                                     008-001-002  10 20
28    1
                                     008-001-003  10 30
42    1
                                     008-001-004  20 40
```

```

23 1
                                     008-001-005  20 40
23 1
                                     008-001-006  20 40
23 1
                                     008-001-007  20 50
29 1

```

MRN table is (8 of 2990) 1% full

If any of the following items are not shown in the `rtrv-mrn` output, then the feature corresponding to these items is not enabled, or turned on if required.

- The `MRNSET` field - the Flexible GTT Load Sharing feature is not enabled.
- The `MAPSET`, `MAPPC`, and `MAPSSN` fields - the GTT Load Sharing with Alternate Routing Indicator feature is not enabled.
- The `WT`, `%WT`, `THR` columns - the Weighted GTT Load Sharing feature is not enabled and turned on.

Continue the procedure by performing one of these steps.

- If MRN entries are not shown in the `rtrv-mrn` output in this step, continue the procedure with [5](#).
 - If the addition of the new MRN entries in this procedure will not exceed the maximum capacity of the MRN table shown in this step, continue the procedure with [6](#).
 - If the addition of the new MRN entries in this procedure will exceed the maximum capacity of the MRN table shown in this step, continue the procedure with [2](#).
2. If only the Intermediate GTT Load Sharing feature is enabled and turned on, the MRN table can contain a maximum of 3000 entries.

If the Flexible GTT Load Sharing feature is enabled, the MRN table can contain a maximum of 6000 entries. If entries are provisioned in the SCCP-SERV table, shown by the `rtrv-sccp-serv` command output, the maximum number of entries that the MRN table can contain is reduced by the number of entries shown in the `rtrv-sccp-serv` command output.

If adding the new MRN entries will exceed the maximum capacity of the MRN table, shown in the `rtrv-mrn` command output, entries in the MRN or SCCP-SERV tables must be removed so that the new MRN entries can be added.

If you wish to remove MRN entries from the MRN table, perform [Removing MRN Entries](#) to remove the required number of MRN entries to allow the addition of the new MRN entries. After the MRN entries have been removed, continue the procedure with [6](#).

If you wish to remove entries from the SCCP-SERV table, continue the procedure with [3](#).

If no MRN or SCCP-SERV table entries are removed, the new MRNs cannot be added and this procedure cannot be performed.

3. Display the entries in the SCCP-SERV table by entering the `rtrv-sccp-serv` command.

This is an example of the possible output.

```
rlghncxa03w 06-10-07 00:34:31 GMT EAGLE5 36.0.0
```

```
-----
Service      : GFLEX
State        : Online
GTT Option   : Yes
-----
ITUI PC      RC
1-002-5      10
1-002-6      20
-----
Service      : GPORT
State        : Online
GTT Option   : Yes
-----
ITUI PC      RC
1-002-4      10
2-003-4      10
1-002-5      20
2-003-5      20
2-003-6      30
2-003-7      40
```

```
SCCPSRV table is (10 of 96) 10% full.
```

- Remove enough entries from the SCCP-SERV table to allow the addition of the new MRN entries by entering the `dlt-sccp-serv` command.

For this example, enter this command.

```
dlt-sccp-serv:serv=gport:pci1=1-002-5:pci2=2-003-6
```

This example removes only the specified point codes. If you wish to remove all the entries for the G-Port or G-Flex service, specify one of the point codes for the service and the `all=yes` parameter.

When this command has successfully completed, this message should appear.

```
rlghncxa03w 06-10-07 00:34:31 GMT EAGLE5 36.0.0
DLT-SCCP-SRV: MASP A - COMPLTD
```

Continue the procedure with [6](#).

- Display the status of the Intermediate GTT Load Sharing (IGTTLS) feature by entering the `rtrv-ctrl-feat` command with the IGTTLS feature part number.

Enter this command.

```
rtrv-ctrl-feat:partnum=893006901
```

The following is an example of the possible output.

```
rlghncxa03w 06-10-28 21:15:37 GMT EAGLE5 36.0.0
The following features have been permanently enabled:
```

Feature Name	Partnum	Status	Quantity
--------------	---------	--------	----------

Intermed GTT Load Sharing 893006901 on ----

The following features have been temporarily enabled:

Feature Name	Partnum	Status	Quantity	Trial
Period Left				
Zero entries found.				

The following features have expired temporary keys:

Feature Name	Partnum
Zero entries found.	

If the IGTTLS controlled feature has not been enabled or turned on, perform [Activating the IGTTLS feature](#) to enable and turn on the IGTTLS feature.

6. If the WT, %WT, and THR columns are shown in the `rtrv-mrn` output in [1](#), the Weighted GTT Load Sharing feature is enabled and turned on. Continue the procedure with [7](#).

If the WT, %WT, and THR columns are not shown in [1](#) and you do not wish to assign weights and in-service thresholds to the entries in the MRN group or MRN set in this procedure, continue the procedure with [7](#).

If the WT, %WT, and THR columns are not shown in [1](#) and you wish to assign weights and in-service thresholds to the entries in the MRN group or MRN set in this procedure, perform [Activating the Weighted GTT Load Sharing Feature](#) to enable and turn on the Weighted GTT Load Sharing feature.

7. If the MRNSET column is shown in the `rtrv-mrn` output in [1](#), the Flexible GTT Load Sharing feature is enabled. Continue the procedure with [8](#).

If the MRNSET column is not shown in [1](#) and you do not wish to provision MRN sets in this procedure, continue the procedure with [8](#).

If the MRNSET column is not shown in [1](#) and you wish to provision MRN sets in this procedure, perform [Activating the Flexible GTT Load Sharing Feature](#) to enable the Flexible GTT Load Sharing feature.

Notes:

- a. If the Flexible GTT Load Sharing feature is not enabled, the point code can appear only once in the `rtrv-mrn` output, cannot be shown in the `rtrv-sid` output, but must be the DPC of a route. A proxy point code cannot be assigned to the point code. Perform [8](#) to verify that the point code assigned to the MRN group is not shown in the `rtrv-sid` output. Perform [9](#) and [10](#) to verify that a proxy point code is not assigned to the point code. Perform [11](#) to verify that the point code is the DPC of a route.
- b. If the Flexible GTT Load Sharing feature is enabled, a specific point code can be assigned to multiple MRN sets, but cannot be shown in the `rtrv-sid` output, and must be the DPC of a route. A proxy point code cannot be assigned to the point code. Because the point code can be assigned to multiple MRN sets, the point code you wish to assign to the MRN set could be assigned to other MRN sets.

If the point code is shown in the `rtrv-mrn` output in [1](#), [8](#), [9](#), [10](#), and [11](#) do not need to be performed. For the point code to be shown in [1](#) it has already been determined that the point code is not shown in the `rtrv-sid` output, is

the DPC of a route, and a proxy point code is not assigned to the point code. Continue the procedure with 13.

If the point code is not shown in the `rtrv-mrn` output in 1, 8, 9, 10, and 11 need to be performed. Perform 8 to verify that the point code assigned to the MRN group is not shown in the `rtrv-sid` output. Perform 9 and 10 to verify that a proxy point code is not assigned to the point code. Perform 11 to verify that the point code is the DPC of a route.

8. Display the EAGLE self-identification, using the `rtrv-sid` command.

```
rlghncxa03w 06-10-10 11:43:04 GMT EAGLE5 36.0.0
PCA          PCI          PCN
CLLI         PCTYPE
  010-020-030  1-023-1      12-0-14-1
rlghncxa03w  OTHER
              s-1-023-1    s-12-0-14-1

CPCA
002-002-002  002-002-003  002-002-004  002-002-005
002-002-006  002-002-007  002-002-008  002-002-009
004-002-001  004-003-003  050-060-070

CPCI
1-001-1      1-001-2      1-001-3      1-001-4
1-002-1      1-002-2      1-002-3      1-002-4
2-001-1      7-222-7

CPCN
2-0-10-3     2-0-11-0     2-0-11-2     2-0-12-1
2-2-3-3     2-2-4-0     10-14-10-1
```

9. Display the destination point codes in the database by entering the `rtrv-dstn` command. This is an example of the possible output.

```
rlghncxa03w 10-12-10 11:43:04 GMT EAGLE5 43.0.0
Extended Processing Time may be Required

DPCA        CLLI        BEI ELEI    ALIASI
ALIASN/N24  DMN
  001-207-000  ----- no  --- -----
----- SS7
  001-001-001  ----- no  --- -----
----- SS7
  001-001-002  ----- no  --- -----
----- SS7
  001-005-000  ----- no  --- -----
----- SS7
  001-007-000  ----- no  --- -----
----- SS7
  008-012-003  ----- no  --- -----
----- SS7
  003-002-004  ----- no  --- -----
----- SS7
  009-002-003  ----- no  --- -----
----- SS7
```

```

010-020-005 ----- no --- -----
----- SS7

DPCI          CLLI          BEI ELEI  ALIASA
ALIASN/N24    DMN
1-207-0      ----- no --- -----
----- SS7
0-015-0      ----- no --- -----
----- SS7
0-017-0      ----- no --- -----
----- SS7
1-011-1      ----- no --- -----
----- SS7
1-011-2      ----- no --- -----
----- SS7

```

```

Destination table is (14 of 2000) 1% full
Alias table is (0 of 12000) 0% full
PPC table is (1 of 20) 5% full

```

If the required point code is not shown in the `rtrv-dstn` output, perform the "Adding a Destination Point Code" procedure in *Database Administration - SS7 User's Guide* to add the required point code. A proxy point code cannot be assigned to the point code.

After the new point code has been added, skip [10](#) and [11](#) and perform one of the Adding a Route procedures in *Database Administration - SS7 User's Guide* and add the required route to the database. After the route has been added, continue the procedure with [13](#).

10. Display the point code that will be assigned to the MRN by using the `rtrv-dstn` command and specifying the point code. For this example, enter this command.

```
rtrv-dstn:dpc=010-020-005
```

This is an example of the possible output.

```
rlghncxa03w 10-12-10 11:43:04 GMT EAGLE5 43.0.0
```

```

DPCA          CLLI          BEI ELEI  ALIASI
ALIASN/N24    DMN
010-020-005  ----- no --- -----
----- SS7

PPCA          NCAI PRX      RCAUSE NPRST SPLITIAM HMSMSC HMSCP
SCCPMSGCNV
009-002-003 ---- no      50    on    20      no    no    none

```

```

Destination table is (14 of 2000) 1% full
Alias table is (0 of 12000) 0% full
PPC table is (1 of 20) 5% full

```

If the adjacent point code is not shown in the `rtrv-dstn` command output, the following output is displayed.

```
rlghncxa03w 09-05-10 11:43:04 GMT EAGLE5 41.0.0
```

No destinations meeting the requested criteria were found

Destination table is (14 of 2000) 1% full

Alias table is (0 of 12000) 0% full

PPC table is (1 of 20) 5% full

A proxy point code (a point code value is shown in the `PPC` column) cannot be assigned to the point code. If a proxy point code is shown in this step, choose another point code from the `rtrv-dstn` output in [9](#) and repeat this step.

After the new point code has been added, skip [11](#) and perform one of the Adding a Route procedures in *Database Administration - SS7 User's Guide* and add the required route to the database. After the route has been added, continue the procedure with [13](#).

11. Enter the `rtrv-rte` command with the `dpca` parameter specifying the point code to be used with the `ent-mrn` command to verify whether or not the point code is the DPC of a route.

For this example, enter these commands.

```
rtrv-rte:dpca=005-005-005
```

This is an example of the possible output.

```
rlghncxa03w 06-10-07 11:43:04 GMT EAGLE5 36.0.0
  DPCA          ALIASI          ALIASN/N24    LSN          RC          APCA
  005-005-005  -----
005-005-005                                     ls05         10
                                     ls15         30
089-047-123                                     lsa8         50
077-056-000
                                           RTX:No  CLLI=ls05c11i
```

```
rtrv-rte:dpca=006-001-001
```

This is an example of the possible output.

```
rlghncxa03w 06-10-07 11:43:04 GMT EAGLE5 36.0.0
  DPCA          ALIASI          ALIASN/N24    LSN          RC          APCA
  006-001-001  -----
006-001-001                                     ls65         10
                                           RTX:No  CLLI=ls65c11i
```

```
rtrv-rte:dpca=006-001-002
```

This is an example of the possible output.

```
rlghncxa03w 06-10-07 11:43:04 GMT EAGLE5 36.0.0
  DPCA          ALIASI      ALIASN/N24   LSN          RC      APCA
  006-001-002  -----  -----  ls66         10
006-001-002
                                         RTX:No  CLLI=ls66clli
```

```
rtrv-rte:dpca=006-001-003
```

This is an example of the possible output.

```
rlghncxa03w 06-10-07 11:43:04 GMT EAGLE5 36.0.0
  DPCA          ALIASI      ALIASN/N24   LSN          RC      APCA
  006-001-003  -----  -----  ls67         10
006-001-003
                                         RTX:No  CLLI=ls67clli
```

```
rtrv-rte:dpca=006-001-004
```

This is an example of the possible output.

```
rlghncxa03w 06-10-07 11:43:04 GMT EAGLE5 36.0.0
  DPCA          ALIASI      ALIASN/N24   LSN          RC      APCA
  006-001-004  -----  -----  ls68         10
006-001-004
                                         RTX:No  CLLI=ls68clli
```

```
rtrv-rte:dpca=006-001-005
```

This is an example of the possible output.

```
rlghncxa03w 06-10-07 11:43:04 GMT EAGLE5 36.0.0
  DPCA          ALIASI      ALIASN/N24   LSN          RC      APCA
  006-001-005  -----  -----  ls69         10 006-001-005
                                         RTX:No  CLLI=ls69clli
```

```
rtrv-rte:dpca=006-001-006
```

This is an example of the possible output.

```
rlghncxa03w 06-10-07 11:43:04 GMT EAGLE5 36.0.0
  DPCA          ALIASI      ALIASN/N24   LSN          RC      APCA
  006-001-006  -----  -----  ls70         10 006-001-006
                                         RTX:No  CLLI=ls70clli
```

```
rtrv-rte:dpca=006-001-007
```

This is an example of the possible output.

```
rlghncxa03w 06-10-07 11:43:04 GMT EAGLE5 36.0.0
  DPCA          ALIASI      ALIASN/N24   LSN          RC      APCA
  006-001-007  -----  -----  ls71         10
```

006-001-007

RTX:No CLLI=ls71c1li

If the point code is not shown in the `rtrv-rte` output, perform one of the Adding a Route procedures in *Database Administration - SS7 User's Guide* and add the required route to the database.

Continue the procedure by performing one of these steps.

- If the `mapset`, MAP point code, and `mapssn` parameters will not be specified for the MRN entry, continue the procedure with 13.
- If the `mapset`, MAP point code, and `mapssn` parameters will be specified for the MRN entry, continue the procedure by performing one of these steps.
 - If the `MAPSET`, `MAPPC`, and `MAPSSN` columns are not shown in the `rtrv-mrn` output, the GTT Load Sharing with Alternate Routing Indicator feature is not enabled. Perform [Activating the GTT Load Sharing with Alternate Routing Indicator Feature](#) to enable the GTT Load Sharing with Alternate Routing Indicator feature. After [Activating the GTT Load Sharing with Alternate Routing Indicator Feature](#) has been performed, continue the procedure with 12.
 - If the `MAPSET`, `MAPPC`, and `MAPSSN` columns are shown in the `rtrv-mrn` output, the GTT Load Sharing with Alternate Routing Indicator feature is enabled. Continue the procedure with 12.

12. The MAP point code and MAP SSN values must be assigned to a MAP set. The MAP set must be shown in the `rtrv-map` output. Display the MAP sets by entering the `rtrv-map` command. This is an example of the possible output.

```
rlghncxa03w 09-07-07 00:34:31 GMT EAGLE5 41.1.0
```

```
MAPSET ID=DFLT   MRNSET ID=----   MRNPC=-----
PCA             Mate PCA         SSN RC MULT SRM MRC GRP NAME SSO
255-001-000    250 10  SOL  *Y  *Y  grp01  ON

MAPSET ID=1     MRNSET ID=----   MRNPC=-----
PCA             Mate PCA         SSN RC MULT SRM MRC GRP NAME SSO
255-001-000    251 10  SHR  *Y  *Y  grp01  OFF
                253-001-002    254 10  SHR  *Y  *Y  grp01  OFF

MAPSET ID=2     MRNSET ID=----   MRNPC=-----
PCA             Mate PCA         SSN RC MULT SRM MRC GRP NAME SSO
255-001-000    252 10  SOL  *Y  *Y  grp01  ON

MAPSET ID=DFLT   MRNSET ID=----   MRNPC=-----
PCA             Mate PCA         SSN RC MULT SRM MRC GRP NAME SSO
255-001-000    253 10  SHR  *Y  *Y  grp01  OFF
                253-001-004    254 10  SHR  *Y  *Y  grp01  OFF

MAPSET ID=3     MRNSET ID=----   MRNPC=-----
PCA             Mate PCA         SSN RC MULT SRM MRC GRP NAME SSO
255-001-001    255 10  DOM  YES YES  grp01  ON
                253-001-005    254 20  DOM  YES YES  grp01  ON

MAPSET ID=4     MRNSET ID=----   MRNPC=-----
```

```

PCA          Mate PCA      SSN RC MULT SRM MRC GRP NAME SSO
255-001-001          250 10  DOM YES YES grp01  OFF
                    253-001-001 254 20  DOM YES YES grp01  OFF

MAPSET ID=DFLT  MRNSET ID=----  MRNPC=-----
PCA          Mate PCA      SSN RC MULT SRM MRC GRP NAME SSO
255-001-002          251 10  SHR *Y *Y grp01  OFF
                    255-001-002 254 10  SHR *Y *Y grp01  OFF

MAPSET ID=5     MRNSET ID=----  MRNPC=-----
PCA          Mate PCA      SSN RC MULT SRM MRC GRP NAME SSO
255-001-002          252 10  DOM YES YES grp01  ON
                    255-001-003 254 20  DOM YES YES grp01  ON

MAPSET ID=6     MRNSET ID=----  MRNPC=-----
PCA          Mate PCA      SSN RC MULT SRM MRC GRP NAME SSO
255-001-002          253 10  SHR *Y *Y grp01  ON
                    255-001-004 254 10  SHR *Y *Y grp01  ON

MAPSET ID=7     MRNSET ID=----  MRNPC=-----
PCA          Mate PCA      SSN RC MULT SRM MRC GRP NAME SSO
002-002-007          50 10  COM YES *Y grp01  OFF
                    002-002-008 30 10  COM YES *Y grp01  OFF
                    002-002-009 30 10  COM YES *Y grp01  OFF
                    002-002-010 30 20  COM YES *Y grp01  OFF
                    002-002-011 30 20  COM YES *Y grp01  OFF

MAPSET ID=8     MRNSET ID=----  MRNPC=-----
PCI          Mate PCI      SSN RC MULT SRM MRC GRP NAME SSO
2-001-2          255 10  DOM NO  YES grp03  OFF
                    2-001-1    254 20  DOM NO  YES grp03  OFF

MAPSET ID=9     MRNSET ID=----  MRNPC=-----
PCN          Mate PCN      SSN RC MULT SRM MRC GRP NAME SSO
00347          253 10  SHR *N *N grp05  OFF
                    01387    254 10  SHR *M *N grp05  OFF

```

MAP TABLE IS (25 of 36000) 1 % FULL

 **Note:**

If the Weighted GTT Load Sharing feature is enabled and turned on, the WT, %WT, and THR columns are shown in the `rtrv-map` output.

If the MAP set that you wish to use, containing the desired point code and subsystem number, is shown in the `rtrv-map` output, continue the procedure with [13](#).

 **Note:**

The network type of the `pc/pca/pci/pcn/pcn24` and `mappc/mappca/mappci/mappcn/mappcn24` parameter values must be compatible, as shown in Note 12 of [Table 2-55](#) or Note 11 of [Table 2-56](#).

If the MAP set that you wish to use is not shown in the `rtrv-map` output, add the required MAP set by performing one of these procedures.

- [Provisioning a Solitary Mated Application](#)
- [Provisioning a Dominant Mated Application](#)
- [Provisioning a Load Shared Mated Application](#)
- [Provisioning a Combined Dominant/Load Shared Mated Application](#)

After the MAP set has been added, continue the procedure with [13](#).

13. Add the MRN group or MRN set to the database using the `ent-mrn` command. Use [Table 2-55](#) as a guide for the parameters and values that can be specified with the `ent-mrn` command.

Table 2-55 Parameter Combinations for the ENT-MRN Command

No Weights and In-Service Thresholds Assigned to the MRN Group or MRN Set	Same Weight Value Assigned to all Entries in the MRN Group or MRN Set	Individual Weight Values Assigned to the Entries in the MRN Group or MRN Set
Mandatory Parameters		
<code>:pc/pca/pci/pcn/pcn24</code> (See Notes 5, 6, 7, and 12)	<code>:pc/pca/pci/pcn/pcn24</code> (See Notes 5, 6, 7, and 12)	<code>:pc/pca/pci/pcn/pcn24</code> (See Notes 5, 6, 7, and 12)
<code>:rc=<0 - 99></code> (See Notes 1, 2, 3, and 10)	<code>:rc=<0 - 99></code> (See Notes 1, 2, 3, and 10)	<code>:rc=<0 - 99></code> (See Notes 1, 2, 3, and 10)
	<code>:dfitwt=<1 - 99 ></code> (See Note 8)	<code>:wt=<1 - 99 ></code> (See Notes 8 and 10)
Optional Parameters		
<code>:pc1/pca1/pci1/pcn1/pcn241</code> (See Notes 4, 5, 6, 7, and 12)	<code>:pc1/pca1/pci1/pcn1/pcn241</code> (See Notes 4, 5, 6, 7, and 12)	<code>:pc1/pca1/pci1/pcn1/pcn241</code> (See Notes 4, 5, 6, 7, and 12)
<code>:rc1=<0 - 99></code> (See Notes 1, 2, 3, and 4)	<code>:rc1=<0 - 99></code> (See Notes 1, 2, 3, and 4)	<code>:rc1=<0 - 99></code> (See Notes 1, 2, 3, and 4)
<code>:pc2/pca2/pci2/pcn2/pcn242</code> (See Notes 4, 5, 6, 7, and 12)	<code>:pc2/pca2/pci2/pcn2/pcn242</code> (See Notes 4, 5, 6, 7, and 12)	<code>:wt1=<1 - 99 ></code> (See Note 8)
<code>:rc2=<0 - 99></code> (See Notes 1, 2, 3, and 4)	<code>:rc2=<0 - 99></code> (See Notes 1, 2, 3, and 4)	<code>:pc2/pca2/pci2/pcn2/pcn242</code> (See Notes 4, 5, 6, 7, and 12)
<code>:pc3/pca3/pci3/pcn3/pcn243</code> (See Notes 4, 5, 6, 7, and 12)	<code>:pc3/pca3/pci3/pcn3/pcn243</code> (See Notes 4, 5, 6, 7, and 12)	<code>:rc2=<0 - 99></code> (See Notes 1, 2, 3, and 4)
<code>:rc3=<0 - 99></code> (See Notes 1, 2, 3, and 4)	<code>:rc3=<0 - 99></code> (See Notes 1, 2, 3, and 4)	<code>:wt2=<1 - 99 ></code> (See Note 8)

Table 2-55 (Cont.) Parameter Combinations for the ENT-MRN Command

No Weights and In-Service Thresholds Assigned to the MRN Group or MRN Set	Same Weight Value Assigned to all Entries in the MRN Group or MRN Set	Individual Weight Values Assigned to the Entries in the MRN Group or MRN Set
:pc4/pca4/pci4/pcn4/pcn244 (See Notes 4, 5, 6, 7, and 12)	:pc4/pca4/pci4/pcn4/pcn244 (See Notes 4, 5, 6, 7, and 12)	:pc3/pca3/pci3/pcn3/pcn243 (See Notes 4, 5, 6, 7, and 12)
:rc4=<0 - 99> (See Notes 1, 2, 3, and 4)	:rc4=<0 - 99> (See Notes 1, 2, 3, and 4)	:rc3=<0 - 99> (See Notes 1, 2, 3, and 4)
:mrnset=<new, dflt, or the number of an existing MRN set> (See Note 9)	:mrnset=<new, dflt, or the number of an existing MRN set> (See Note 9)	:wt3=<1 - 99 > (See Note 8)
:mapset = <MAP set ID from the rtrv-map output> (See Note 11)	:thr=<1 - 100> (See Note 8)	:pc4/pca4/pci4/pcn4/pcn244 (See Notes 4, 5, 6, 7, and 12)
:mappc/mappca/ mappci/mappcn/ mappcn24=<the point code value in the MAP set> (See Notes 11 and 12)	:mapset = <MAP set ID from the rtrv-map output> (See Note 11)	:rc4=<0 - 99> (See Notes 1, 2, 3, and 4)
:mapssn=<the SSN value assigned to the point code in the MAP set> (See Note 11)	:mappc/mappca/ mappci/mappcn/ mappcn24=<the point code value in the MAP set> (See Notes 11 and 12)	:wt4=<1 - 99 > (See Note 8)
	:mapssn=<the SSN value assigned to the point code in the MAP set> (See Note 11)	:mrnset=<new, dflt, or the number of an existing MRN set> (See Note 9)
		:thr=<1 - 100> (See Note 8)
		:mapset = <MAP set ID from the rtrv-map output> (See Note 11)
		:mappc/mappca/ mappci/mappcn/ mappcn24=<the point code value in the MAP set> (See Notes 11 and 12)
		:mapssn=<the SSN value assigned to the point code in the MAP set> (See Note 11)

Table 2-55 (Cont.) Parameter Combinations for the ENT-MRN Command

No Weights and In-Service Thresholds Assigned to the MRN Group or MRN Set	Same Weight Value Assigned to all Entries in the MRN Group or MRN Set	Individual Weight Values Assigned to the Entries in the MRN Group or MRN Set
Notes		
<p>a. To provision a dominant MRN group or MRN set, the RC values for each entry must be unique.</p> <p>b. To provision a load shared MRN group or MRN set, the RC values for each entry must be equal.</p> <p>c. To provision a combined dominant/load shared MRN group or MRN set, the MRN group or MRN set must contain a minimum of two entries with equal RC values, and a minimum of one entry with a different RC value.</p> <p>d. The MRN group can contain a maximum of 128 alternate point code entries. The alternate point code and its corresponding rc parameter must be specified together. For example, if the pcn3 parameter is specified, the rc3 parameter must be specified.</p> <p>e. The point codes specified must have a route assigned to it, or must be a part of a cluster that has a route assigned to it (shown in 11), cannot be in the Self ID table (shown in 8), and proxy point codes cannot be assigned to the point codes (shown in 10).</p> <p>f. For MRNs containing ANSI or 24-bit ITU-N point codes, the format of the point codes specified in the ent-mrn command must be the same. For example, if the primary point code is a 24-bit ITU-N point code (pcn24), the alternate point code must be a 24-bit ITU-N point code (pcn241/pcn242/pcn243/pcn244). The alternate point codes of MRNs containing either ITU-I, ITU-I spare, 14-bit ITU-N, or 14-bit ITU-N spare primary point codes do not have to be the same format as the primary point code. The alternate point codes of these MRNs can be a mixture of ITU-I, ITU-I spare, 14-bit ITU-N, or 14-bit ITU-N spare point codes.</p> <p>g. If the rtrv-rte and rtrv-sid outputs show 14-bit ITU-N point codes (dpcn and pcn), then the pcn/pcn1/pcn2/pcn3/pcn4 parameters must be used. If the rtrv-rte and rtrv-sid outputs show 24-bit ITU-N point codes (dpcn24 and pcn24), then the pcn24/pcn241/pcn242/pcn243/pcn244 parameters must be used.</p> <p>h. Refer to Provisioning Weights and In-Service Thresholds for MRNs for information about using the weight (wt and mwt) and in-service threshold (thr) parameters.</p> <p>i. Refer to Provisioning an MRN Set for information about how to provision an MRN set.</p> <p>j. If the entry is being added to an existing MRN group or MRN set, the rc and wt parameters cannot be specified with the ent-mrn command.</p> <p>k. The mapset, mappc/mappca/mappci/mappcn/mappcn24, and mapssn parameters can be specified only if the GTT Load Sharing with Alternate Routing Indicator feature is enabled. If either the mapset, mappc/mappca/mappci/mappcn/mappcn24, or mapssn parameters are specified, then all three parameters must be specified. The values of the mapset,mappc/mappca/mappci/mappcn/mappcn24, andmapssn parameters are shown in the rtrv-map output.</p> <p>l. The network type of the pc/pca/pci/pcn/pcn24 and mappc/mappca/mappci/mappcn/mappcn24 parameter values must be compatible, as shown in this list.</p> <ul style="list-style-type: none"> • pc/pca - mappc/mappca 		

Table 2-55 (Cont.) Parameter Combinations for the ENT-MRN Command

No Weights and In-Service Thresholds Assigned to the MRN Group or MRN Set	Same Weight Value Assigned to all Entries in the MRN Group or MRN Set	Individual Weight Values Assigned to the Entries in the MRN Group or MRN Set
<ul style="list-style-type: none"> pcn24 - mappc24 pci or pcn - mappci or mappcn <p>If the network type of the MRN point code parameter is ITU-I (<i>pci</i>), the network type of the MAP point code parameter can be either ITU-I (<i>mappci</i>) or ITU-N (<i>mappcn</i>).</p> <p>If the network type of the MRN point code parameter is ITU-N (<i>pcn</i>), the network type of the MAP point code parameter can be either ITU-I (<i>mappci</i>) or ITU-N (<i>mappcn</i>).</p>		

For this example, enter these commands.

If the Flexible GTT Load Sharing is not enabled, enter these commands.

```
ent-
mrn:pca=005-005-005:rc=10:pca1=006-001-001:rc1=20 :pca2=006-0
01-002:rc2=30:pca3=006-001-003:rc3=40 :pca4=006-001-004:rc4=5
0
```

```
ent-
mrn:pci=5-005-5:rc=10:pci1=6-001-1:rc1=20 :pcn2=1062:rc2=30:p
ci3=6-001-3:rc3=40 :pcn4=1065:rc4=50
```

When these commands have successfully completed, this message should appear.

```
rlghncxa03w 09-02-07 11:44:13 GMT EAGLE5 40.1.0
ENT-MRN: MASP A - COMPLTD
```

If the Flexible GTT Load Sharing is enabled and a new MRN set, other than the default MRN set, is being provisioned, enter these commands.

```
ent-
mrn:pca=005-005-005:rc=10:pca1=006-001-001:rc1=20 :pca2=006-0
01-002:rc2=30:pca3=006-001-003:rc3=40 :pca4=006-001-004:rc4=5
0:mrnset=new
```

```
ent-
mrn:pci=5-005-5:rc=10:pci1=6-001-1:rc1=20 :pcn2=1062:rc2=30:p
ci3=6-001-3:rc3=40 :pcn4=1065:rc4=50:mrnset=new
```

When these commands have successfully completed, a message similar to the following message should appear.

```
rlghncxa03w 09-02-07 11:44:13 GMT EAGLE5 40.1.0
New MRNSET Created : MRNSETID = 2
ENT-MRN : MASP A - COMPLTD
```

If the Flexible GTT Load Sharing is enabled and a new MRN group is being added to the default MRN set, enter these commands.

```
ent-  
mrn:pca=005-005-005:rc=10:pca1=006-001-001:rc1=20 :pca2=006-0  
01-002:rc2=30:pca3=006-001-003:rc3=40 :pca4=006-001-004:rc4=5  
0:mrnset=dflt
```

```
ent-  
mrn:pci=5-005-5:rc=10:pci1=6-001-1:rc1=20 :pcn2=1062:rc2=30:p  
ci3=6-001-3:rc3=40:pcn4=1065:rc4=50:mrnset=dflt
```

When these commands have successfully completed, this message should appear.

```
rlghncxa03w 09-02-07 11:44:13 GMT EAGLE5 40.1.0  
ENT-MRN : MASP A - COMPLTD
```

If the Flexible GTT Load Sharing is enabled and entries are being added to an existing MRN set, enter these commands.

```
ent-  
mrn:pca=005-005-005:pca1=006-001-001:rc1=20 :pca2=006-001-002  
:rc2=30:pca3=006-001-003:rc3=40 :pca4=006-001-004:rc4=50:mrns  
et=1
```

```
ent-  
mrn:pci=5-005-5:rc=10:pci1=6-001-1:rc1=20 :pcn2=1062:rc2=30:p  
ci3=6-001-3:rc3=40:pcn4=1065:rc4=50:mrnset=2
```

When these commands have successfully completed, this message should appear.

```
rlghncxa03w 09-02-07 11:44:13 GMT EAGLE5 40.1.0  
ENT-MRN: MASP A - COMPLTD
```

If the Flexible GTT Load Sharing is not enabled and the Weighted GTT Load Sharing feature is enabled and turned on, enter these commands. This example creates a combined dominant/load shared MRN group with the same weight value for each entry in the group, and an in-service threshold value assigned to each entry in the set.

```
ent-  
mrn:pca=005-005-005:rc=10:dfltwt=20:pca1=006-001-001 :rc1=10:  
pca2=006-001-002:rc2=30:pca3=006-001-003:rc3=10 :pca4=006-001  
-004:rc4=30:thr=40
```

```
ent-  
mrn:pci=5-005-5:rc=10:pci1=6-001-1:rc1=10 :pcn2=1062:rc2=10 :  
pci3=6-001-3:rc3=30:pcn4=1065:rc4=30:thr=40:dfltwt=20
```

When these commands have successfully completed, this message should appear.

```
rlghncxa03w 09-02-07 11:44:13 GMT EAGLE5 40.1.0  
ENT-MRN: MASP A - COMPLTD
```

If the Flexible GTT Load Sharing is enabled, the Weighted GTT Load Sharing feature is enabled and turned on, and a new MRN set, other than the default MRN

set, is being provisioned, enter these commands. This example creates a new load shared MRN set with different weight values for each entry in the set.

```
ent-
mrn:pca=005-005-005:rc=10:wt=10:pca1=006-001-001:rc1=10 :wt1=
20:pca2=006-001-002:rc2=10:wt2=30:pca3=006-001-003:rc3=10 :wt
3=40:pca4=006-001-004:rc4=10:wt4=50:mrnset=new
```

```
ent-
mrn:pci=5-005-5:rc=10:wt=10:pci1=6-001-1:rc1=10:wt1=20:pcn2=1
062:rc2=10 :wt2=30:pci3=6-001-3:rc3=10:wt3=40:pcn4=1065:rc4=1
0:wt4=50:mrnset=new
```

When these commands have successfully completed, a message similar to the following message should appear.

```
rlghncxa03w 09-02-07 11:44:13 GMT EAGLE5 40.1.0
New MRNSET Created : MRNSETID = 2
ENT-MRN : MASP A - COMPLTD
```

If the Flexible GTT Load Sharing is enabled, the Weighted GTT Load Sharing feature is enabled and turned on, and a new MRN group is being added to the default MRN set, enter these commands. This example creates a combined dominant/load shared MRN set with different weight values for each entry in the set, and an in-service threshold value assigned to each entry in the set.

```
ent-
mrn:pca=005-005-005:rc=10:wt=10:pca1=006-001-001:rc1=10 :wt1=
10:pca2=006-001-002:rc2=30:wt2=20:pca3=006-001-003:rc3=40 :wt
3=20:pca4=006-001-004:rc4=50:wt4=20:mrnset=df1t:thr=30
```

```
ent-
mrn:pci=5-005-5:rc=10:wt=10:pci1=6-001-1:rc1=10:wt1=10:pcn2=1
062:rc2=30 :wt2=20:pci3=6-001-3:rc3=40:wt3=20:pcn4=1065:rc4=5
0:wt4=20:mrnset=df1t:thr=30
```

When these commands have successfully completed, this message should appear.

```
rlghncxa03w 09-02-07 11:44:13 GMT EAGLE5 40.1.0
ENT-MRN : MASP A - COMPLTD
```

If the Flexible GTT Load Sharing is enabled, the Weighted GTT Load Sharing feature is enabled and turned on, and entries are being added to an existing MRN set, enter these commands. This example adds entries to an existing MRN set to create a combined dominant/load shared MRN set. Each entry specified in the `ent-mrn` command has different weight values assigned. Entry specified in the `ent-mrn` command has an in-service threshold value assigned.

```
ent-
mrn:pca=005-005-005:pca1=006-001-001:rc1=20:wt1=20 :pca2=006-
001-002:rc2=20:wt2=40:pca3=006-001-003:rc3=40:wt3=30 :pca4=00
6-001-004:rc4=40:wt4=50:mrnset=1:thr=30
```

```
ent-
mrn:pci=5-005-5:pci1=6-001-1:rc1=20:wt1=20:pcn2=1062:rc2=20 :
```



```
wt2=40:pci3=6-001-3:rc3=40:wt3=30:pcn4=1065:rc4=40:wt4=50:mrn
set=2:thr=30
```

When these commands have successfully completed, this message should appear.

```
rlghncxa03w 09-02-07 11:44:13 GMT EAGLE5 40.1.0
ENT-MRN : MASP A - COMPLTD
```

If the GTT Load Sharing with Alternate Routing Indicator feature is enabled and a new MRN set, other than the default MRN set, is being provisioned, enter these commands.

```
ent-
mrn:pca=005-005-005:rc=10:pca1=006-001-001:rc1=20 :pca2=006-0
01-002:rc2=30:pca3=006-001-003:rc3=40 :pca4=006-001-004:rc4=5
0:mrnset=new:mapset=7:mappc=002-002-007:mapssn=50
```

```
ent-
mrn:pci=5-005-5:rc=10:pci1=6-001-1:rc1=20 :pcn2=1062:rc2=30:p
ci3=6-001-3 :rc3=40 :pcn4=1065:rc4=50:mrnset=new:mapset=9:map
pcn=347:mapssn=253
```

When these commands have successfully completed, a message similar to the following message should appear.

```
rlghncxa03w 09-02-07 11:44:13 GMT EAGLE5 40.1.0
New MRNSET Created : MRNSETID = 2
ENT-MRN : MASP A - COMPLTD
```

If no more entries will be added to the MRN group or MRN set specified in this step, continue the procedure with [15](#).

If more entries will be added to the MRN group or MRN set specified in this step, continue the procedure with [14](#).

14. Enter the `ent-mrn` or `chg-mrn` command without the `rc` parameter to add more entries to the MRN group or MRN set specified in [13](#). If the `ent-mrn` command will be specified in this step, use [Table 2-55](#) as a guide for the parameters and values that can be specified with the `ent-mrn` command. If the `chg-mrn` command will be used in this step, use [Table 2-56](#) as a guide for the parameters and values that can be specified with the `chg-mrn` command.

Table 2-56 Parameter Combinations for the CHG-MRN Command

No Weight Values Assigned to the Entries in the MRN Group or MRN Set	Weight Values Assigned to the Entries in the MRN Group or MRN Set
Mandatory Parameter	
:pc/pca/pci/pcn/pcn24 (See Notes 5, 6, 7, and 11)	:pc/pca/pci/pcn/pcn24 (See Notes 5, 6, 7, and 11)
Optional Parameters	
:pc1/pca1/pci1/pcn1/pcn241 (See Notes 4, 5, 6, 7, and 11)	:pc1/pca1/pci1/pcn1/pcn241 (See Notes 4, 5, 6, 7, and 11)
:rc1=<0 - 99> (See Notes 1, 2, 3, and 4)	:rc1=<0 - 99> (See Notes 1, 2, 3, and 4)

Table 2-56 (Cont.) Parameter Combinations for the CHG-MRN Command

No Weight Values Assigned to the Entries in the MRN Group or MRN Set	Weight Values Assigned to the Entries in the MRN Group or MRN Set
:pc2/pca2/pci2/pcn2/pcn242 (See Notes 4, 5, 6, 7, and 11)	:wt1=<1 - 99 > (See Note 8)
:rc2=<0 - 99> (See Notes 1, 2, 3, and 4)	:pc2/pca2/pci2/pcn2/pcn242 (See Notes 4, 5, 6, 7, and 11)
:pc3/pca3/pci3/pcn3/pcn243 (See Notes 4, 5, 6, 7, and 11)	:rc2=<0 - 99> (See Notes 1, 2, 3, and 4)
:rc3=<0 - 99> (See Notes 1, 2, 3, and 4)	:wt2=<1 - 99 > (See Note 8)
:pc4/pca4/pci4/pcn4/pcn244 (See Notes 4, 5, 6, 7, and 11)	:pc3/pca3/pci3/pcn3/pcn243 (See Notes 4, 5, 6, 7, and 11)
:rc4=<0 - 99> (See Notes 1, 2, 3, and 4)	:rc3=<0 - 99> (See Notes 1, 2, 3, and 4)
:mrnset=<the mrnset parameter value shown in the ent-mrn output in 13> (See Note 9)	:wt3=<1 - 99 > (See Note 8)
:mapset = <MAP set ID from the rtrv-map output> (See Note 10)	:pc4/pca4/pci4/pcn4/pcn244 (See Notes 4, 5, 6, 7, and 11)
:mappc/mappca/mappci/mappcn/ mappcn24=<the point code value in the MAP set> (See Notes 10 and 11)	:rc4=<0 - 99> (See Notes 1, 2, 3, and 4)
:mapssn=<the SSN value assigned to the point code in the MAP set> (See Note 10)	:wt4=<1 - 99 > (See Note 8)
	:mrnset=<the mrnset parameter value shown in the ent-mrn output in 13> (See Note 9)
	:mapset = <MAP set ID from the rtrv-map output> (See Note 10)
	:mappc/mappca/mappci/mappcn/ mappcn24=<the point code value in the MAP set> (See Notes 10 and 11)
	:mapssn=<the SSN value assigned to the point code in the MAP set> (See Note 10)

Table 2-56 (Cont.) Parameter Combinations for the CHG-MRN Command

No Weight Values Assigned to the Entries in the MRN Group or MRN Set	Weight Values Assigned to the Entries in the MRN Group or MRN Set
Notes	
<p>a. To provision a dominant MRN group or MRN set, the RC values for each entry must be unique.</p> <p>b. To provision a load shared MRN group or MRN set, the RC values for each entry must be equal.</p> <p>c. To provision a combined dominant/load shared MRN group or MRN set, the MRN group or MRN set must contain a minimum of two entries with equal RC values, and a minimum of one entry with a different RC value.</p> <p>d. The MRN group can contain a maximum of 128 alternate point code entries. The alternate point code and its corresponding <code>rc</code> parameter must be specified together. For example, if the <code>pcn3</code> parameter is specified, the <code>rc3</code> parameter must be specified.</p> <p>e. The point codes specified must have a route assigned to it, or must be a part of a cluster that has a route assigned to it (shown in 11), cannot be in the Self ID table (shown in 8), and proxy point codes cannot be assigned to the point codes (shown in 10).</p> <p>f. For MRNs containing ANSI or 24-bit ITU-N point codes, the format of the point codes specified in the <code>chg-mrn</code> command must be the same. For example, if the primary point code is a 24-bit ITU-N point code (<code>pcn24</code>), the alternate point code must be a 24-bit ITU-N point code (<code>mpcn24</code>). The alternate point codes of MRNs containing either ITU-I, ITU-I spare, 14-bit ITU-N, or 14-bit ITU-N spare primary point codes do not have to be the same format as the primary point code. The alternate point codes of these MRNs can be a mixture of ITU-I, ITU-I spare, 14-bit ITU-N, or 14-bit ITU-N spare point codes.</p> <p>g. If the <code>rtrv-rte</code> and <code>rtrv-sid</code> outputs show 14-bit ITU-N point codes (<code>dpcn</code> & <code>pcn</code>), then the <code>pcn/pcn1/pcn2/pcn3/pcn4</code> parameters must be used. If the <code>rtrv-rte</code> and <code>rtrv-sid</code> outputs show 24-bit ITU-N point codes (<code>dpcn24</code> & <code>pcn24</code>), then the <code>pcn24/pcn241/pcn242/pcn243/pcn244</code> parameters must be used.</p> <p>h. Refer to Provisioning Weights and In-Service Thresholds for MRNs for information about using the weight (<code>wt</code>) parameter.</p> <p>i. Refer to Provisioning an MRN Set for information about how to provision an MRN set.</p> <p>j. The <code>mapset</code>, <code>mappc/mappca/mappci/mappcn/mappcn24</code>, and <code>mapssn</code> parameters can be specified only if the GTT Load Sharing with Alternate Routing Indicator feature is enabled. If either the <code>mapset</code>, <code>mappc/mappca/mappci/mappcn/mappcn24</code>, or <code>mapssn</code> parameters are specified, then all three parameters must be specified. The values of the <code>mapset</code>, <code>mappc/mappca/mappci/mappcn/mappcn24</code>, and <code>mapssn</code> parameters are shown in the <code>rtrv-map</code> output.</p> <p>k. The network type of the <code>pc/pca/pci/pcn/pcn24</code> and <code>mappc/mappca/mappci/mappcn/mappcn24</code> parameter values must be compatible, as shown in this list.</p> <ul style="list-style-type: none"> • <code>pc/pca</code> - <code>mappc/mappca</code> • <code>pcn24</code> - <code>mappc24</code> • <code>pci</code> or <code>pcn</code> - <code>mappci</code> or <code>mappcn</code> 	

Table 2-56 (Cont.) Parameter Combinations for the CHG-MRN Command

No Weight Values Assigned to the Entries in the MRN Group or MRN Set	Weight Values Assigned to the Entries in the MRN Group or MRN Set
<p>If the network type of the MRN point code parameter is ITU-I (<i>pci</i>), the network type of the MAP point code parameter can be either ITU-I (<i>mappci</i>) or ITU-N (<i>mappcn</i>).</p>	
<p>If the network type of the MRN point code parameter is ITU-N (<i>pcn</i>), the network type of the MAP point code parameter can be either ITU-I (<i>mappci</i>) or ITU-N (<i>mappcn</i>).</p>	

For this example, enter these commands.

```
ent-
mrn:pca=005-005-005:pca1=006-001-005:rc1=60 :pca2=006-001-006
:rc2=70:pca3=006-001-007:rc3=80:mrnset=1
```

```
ent-
mrn:pci=5-005-5:pci1=6-001-5:rc1=60:pcn2=1070:rc2=70:pci3=6-0
01-7 :rc3=80:mrnset=2
```

When these commands have successfully completed, this message should appear.

```
rlghncxa03w 06-10-07 11:44:13 GMT EAGLE5 36.0.0
ENT-MRN: MASP A - COMPLTD
```

```
chg-
mrn:pca=005-005-005:pca1=006-001-005:rc1=60 :pca2=006-001-006
:rc2=70:pca3=006-001-007:rc3=80:mrnset=1
```

```
chg-
mrn:pci=5-005-5:pci1=6-001-5:rc1=60:pcn2=1070:rc2=70:pci3=6-0
01-7 :rc3=80:mrnset=2
```

When these commands have successfully completed, this message should appear.

```
rlghncxa03w 06-10-07 11:44:13 GMT EAGLE5 36.0.0
CHG-MRN: MASP A - COMPLTD
```

If the Weighted GTT Load Sharing feature is enabled and turned on, enter these commands.

```
ent-
mrn:pca=005-005-005:df1twt=40:pca1=006-001-005:rc1=10 :pca2=0
06-001-006:rc2=10:pca3=006-001-007:rc3=10:mrnset=1
```

```
ent-
mrn:pci=5-005-5:df1twt=40:pci1=6-001-5:rc1=10 :pcn2=1070:rc2=
10:pci3=6-001-7:rc3=10:mrnset=2
```

When these commands have successfully completed, this message should appear.

```
rlghncxa03w 06-10-07 11:44:13 GMT EAGLE5 36.0.0
ENT-MRN: MASP A - COMPLTD
```

```
chg-
mrn:pca=005-005-005:pca1=006-001-008:rc1=20:wt1=20 :pca2=006-
001-009:rc2=20:wt2=30:pca3=006-001-010:rc3=20:wt3=30 :mrnset=
1:force=yes
```

```
chg-
mrn:pci=5-005-5:pci1=6-001-5:rc1=20:wt1=20:pcn2=1070:rc2=20 :
wt2=30:pci3=6-001-7:rc3=20:wt3=30:mrnset=2
```

When these commands have successfully completed, this message should appear.

```
rlghncxa03w 06-10-07 11:44:13 GMT EAGLE5 36.0.0
CHG-MRN: MASP A - COMPLTD
```

If the GTT Load Sharing with Alternate Routing Indicator feature is enabled, and you wish to add the `mapset`, `MAP` point code, and `mapssn` values to the MRN entry, and these values were not specified in 13, for this example, enter these commands.

```
ent-
mrn:pca=005-005-005:pca1=006-001-005:rc1=60:pca2=006-001-006
:rc2=70:pca3=006-001-007:rc3=80:mrnset=1:mapset=7:mappc=002-0
02-007 :mapssn=50
```

```
ent-
mrn:pci=5-005-5:pci1=6-001-5:rc1=60:pcn2=1070:rc2=70:pci3=6-0
01-7 :rc3=80:mrnset=2
```

When these commands have successfully completed, this message should appear.

```
rlghncxa03w 09-02-07 11:44:13 GMT EAGLE5 40.1.0
ENT-MRN: MASP A - COMPLTD
```

```
chg-
mrn:pca=005-005-005:pca1=006-001-005:rc1=60:pca2=006-001-006
:rc2=70:pca3=006-001-007:rc3=80:mrnset=1:mapset=7:mappc=002-0
02-007 :mapssn=50
```

```
chg-
mrn:pci=5-005-5:pci1=6-001-5:rc1=60:pcn2=1070:rc2=70:pci3=6-0
01-7 :rc3=80:mrnset=2:mapset=9:mappcn=347:mapssn=253
```

When these commands have successfully completed, this message should appear.

```
rlghncxa03w 09-02-07 11:44:13 GMT EAGLE5 40.1.0
CHG-MRN: MASP A - COMPLTD
```

15. Verify the changes using the `rtrv-mrn` command with the point code (`pca/pci/pcn/pcn24` parameters) specified in 13 and 14.

If the `mrnset` parameter was specified in 13 and 14, the `mrnset` parameter and value specified in 13 and 14 must be specified with the `rtrv-mrn` command in this step.

For this example, enter one of these commands. If the Flexible GTT Load Sharing is not enabled, enter this command.

```
rtrv-mrn:pca=005-005-005
```

This is an example of the possible output.

```
rlghncxa03w 09-02-07 00:34:31 GMT EAGLE5 40.1.0
```

PC	RC
005-005-005	10
006-001-001	20
006-001-002	30
006-001-003	40
006-001-004	50
006-001-005	60
006-001-006	70
006-001-007	80

```
MRN table is (24 of 2990) 1% full
```

```
rtrv-mrn:pci=5-005-5
```

This is an example of the possible output.

```
rlghncxa03w 09-02-07 00:34:31 GMT EAGLE5 40.1.0
```

NET	PC	RC
I	5-005-5	10
I	6-001-1	20
N	1062	30
I	6-001-3	40
N	1065	50

```
MRN table is (24 of 2990) 1% full
```

If the Flexible GTT Load Sharing is enabled and a new MRN set, other than the default MRN set, was provisioned in 13 and 14, enter this command.

```
rtrv-mrn:pca=005-005-005:mrnset=1
```

This is an example of the possible output.

```
rlghncxa03w 09-02-07 00:34:31 GMT EAGLE5 40.1.0
```

MRNSET	PC	RC
1	005-005-005	10
	006-001-001	20
	006-001-002	30
	006-001-003	40

```
006-001-004 50
006-001-005 60
006-001-006 70
006-001-007 80
```

MRN table is (24 of 5990) 1% full

```
rtrv-mrn:pci=5-005-5:mrnset=2
```

This is an example of the possible output.

```
rlghncxa03w 09-02-07 00:34:31 GMT EAGLE5 40.1.0
```

MRNSET	NET	PC	RC
2	I	5-005-5	10
	I	6-001-1	20
	N	1062	30
	I	6-001-3	40
	N	1065	50
	I	6-001-5	60
	N	1070	70
	I	6-001-7	80

MRN table is (24 of 2990) 1% full

If the Flexible GTT Load Sharing is enabled and a new MRN group was added to the default MRN set in [13](#) and [14](#), enter this command.

```
rtrv-mrn:pca=005-005-005:mrnset=dflt
```

This is an example of the possible output.

```
rlghncxa03w 09-02-07 00:34:31 GMT EAGLE5 40.1.0
```

MRNSET	PC	RC
DFLT	005-005-005	10
	006-001-001	20
	006-001-002	30
	006-001-003	40
	006-001-004	50
	006-001-005	60
	006-001-006	70
	006-001-007	80

MRN table is (24 of 5990) 1% full

```
rtrv-mrn:pci=5-005-5:mrnset=dflt
```

This is an example of the possible output.

```
rlghncxa03w 09-02-07 00:34:31 GMT EAGLE5 40.1.0
```

MRNSET	NET	PC	RC
DFLT	I	5-005-5	10
	I	6-001-1	20

```

N      1062      30
I      6-001-3   40
N      1065      50

```

MRN table is (24 of 2990) 1% full

If the Flexible GTT Load Sharing is enabled and entries were added to an existing MRN set in 13, enter this command.

```
rtrv-mrn:pca=005-005-005:mrnset=1
```

This is an example of the possible output.

```
rlghncxa03w 09-02-07 00:34:31 GMT EAGLE5 40.1.0
```

MRNSET	PC	RC
1	005-005-005	10
	003-003-003	15
	006-001-001	20
	004-004-004	25
	006-001-002	30
	006-001-003	40
	006-001-004	50
	009-009-009	60

MRN table is (24 of 5990) 1% full

```
rtrv-mrn:pci=5-005-5:mrnset=2
```

This is an example of the possible output.

```
rlghncxa03w 09-02-07 00:34:31 GMT EAGLE5 40.1.0
```

MRNSET	NET	PC	RC
2	I	5-005-5	10
	I	6-001-1	20
	N	1062	30
	I	6-001-3	40
	N	1065	50

MRN table is (24 of 2990) 1% full

If the Weighted GTT Load Sharing feature is enabled and turned on, for this example, enter one of these commands. If the Flexible GTT Load Sharing is not enabled, enter this command.

```
rtrv-mrn:pca=005-005-005
```

This is an example of the possible output.

```
rlghncxa03w 09-02-07 00:34:31 GMT EAGLE5 40.1.0
```

PC	RC	WT	%WT	THR
005-005-005	10	20	33	40
006-001-001	10	20	33	40

```
006-001-003    10 20 33 40
006-001-002    30 20 50 40
006-001-004    30 20 50 40
```

MRN table is (24 of 2990) 1% full

```
rtrv-mrn:pci=5-005-5
```

This is an example of the possible output.

```
rlghncxa03w 09-02-07 00:34:31 GMT EAGLE5 40.1.0
```

NET	PC	RC	WT	%WT	THR
I	5-005-5	10	20	33	40
I	6-001-1	10	20	33	40
N	1062	10	20	33	40
I	6-001-3	30	20	50	40
N	1065	30	20	50	40

MRN table is (24 of 2990) 1% full

If the Flexible GTT Load Sharing feature is enabled and a new MRN set, other than the default MRN set, was provisioned in [13](#) and [14](#), enter this command.

```
rtrv-mrn:pca=005-005-005:mrnset=1
```

This is an example of the possible output.

```
rlghncxa03w 09-02-07 00:34:31 GMT EAGLE5 40.1.0
```

MRNSET	PC	RC	WT	%WT	THR
1	005-005-005	10	10	4	1
	006-001-001	10	10	4	1
	006-001-002	10	30	12	1
	006-001-003	10	40	15	1
	006-001-005	10	40	15	1
	006-001-006	10	40	15	1
	006-001-007	10	40	15	1
	006-001-004	10	50	19	1
	006-001-008	20	20	25	1
	006-001-009	20	30	37	1
	006-001-010	20	30	37	1

MRN table is (24 of 5990) 1% full

```
rtrv-mrn:pci=5-005-5:mrnset=2
```

This is an example of the possible output.

```
rlghncxa03w 09-02-07 00:34:31 GMT EAGLE5 40.1.0
```

MRNSET	NET	PC	RC	WT	%WT	THR
2	I	5-005-5	10	10	8	1
	I	6-001-1	10	10	8	1
	N	1062	10	30	23	1

```

I      6-001-3      10 40 30 1
N      1065        10 40 30 1
I      6-001-5      20 20 25 1
N      1070        20 30 37 1
I      6-001-7      20 30 37 1

```

MRN table is (24 of 2990) 1% full

If the Flexible GTT Load Sharing is enabled and a new MRN group was added to the default MRN set in 13 and 14, enter this command.

```
rtrv-mrn:pca=005-005-005:mrnset=dflt
```

This is an example of the possible output.

```
rlghncxa03w 09-02-07 00:34:31 GMT EAGLE5 40.1.0
```

MRNSET	PC	RC	WT	%WT	THR
DFLT	005-005-005	10	10	50	30
	006-001-001	10	10	50	30
	006-001-002	30	20	100	30
	006-001-003	40	20	100	30
	006-001-004	50	20	100	30

MRN table is (24 of 5990) 1% full

```
rtrv-mrn:pci=5-005-5:mrnset=dflt
```

This is an example of the possible output.

```
rlghncxa03w 09-02-07 00:34:31 GMT EAGLE5 40.1.0
```

MRNSET	NET	PC	RC	WT	%WT	THR
DFLT	I	5-005-5	10	10	50	30
	I	6-001-1	10	10	50	30
	N	1062	30	20	100	30
	I	6-001-3	40	20	100	30
	N	1065	50	20	100	30

MRN table is (24 of 2990) 1% full

If the GTT Load Sharing with Alternate Routing Indicator feature is enabled, and you wish to add the mapset, MAP point code, and mapssn values to the MRN entry, and these values were not specified in 13, for this example, enter these commands.

```
rtrv-mrn:mrnset=1:pca=005-005-005
```

This is an example of the possible output.

```
rlghncxa03w 09-02-07 00:34:31 GMT EAGLE5 40.1.0
```

MRNSET	MAPSET	MAPPC	MAPSSN	PC	RC
1	7	002-002-007	50	005-005-005	10
				006-001-001	20

```
006-001-002 30
006-001-003 40
006-001-004 50
006-001-005 60
006-001-006 70
006-001-007 80
```

MRN table is (24 of 5990) 1% full

rtrv-mrn:mrnset=2:pci=5-005-5

This is an example of the possible output.

rlghncxa03w 09-02-07 00:34:31 GMT EAGLE5 40.1.0

MRNSET	MAPSET	MAPPCN	MAPSSN	NET	PC	RC
2	9	00347	253	I	5-005-5	10
				I	6-001-1	20
				N	1062	30
				I	6-001-3	40
				N	1065	50
				I	6-001-5	60
				N	1070	70
				I	6-001-7	80

MRN table is (24 of 2990) 1% full

- Backup the new changes using the `chg-db:action=backup:dest=fixed` command.

These messages should appear, the active Maintenance and Administration Subsystem Processor (MASP) appears first.

```
BACKUP (FIXED) : MASP A - Backup starts on active MASP.
BACKUP (FIXED) : MASP A - Backup on active MASP to fixed disk
complete.
BACKUP (FIXED) : MASP A - Backup starts on standby MASP.
BACKUP (FIXED) : MASP A - Backup on standby MASP to fixed disk
complete.
```

Figure 2-130 Provision MRN Entries - Sheet 1 of 5

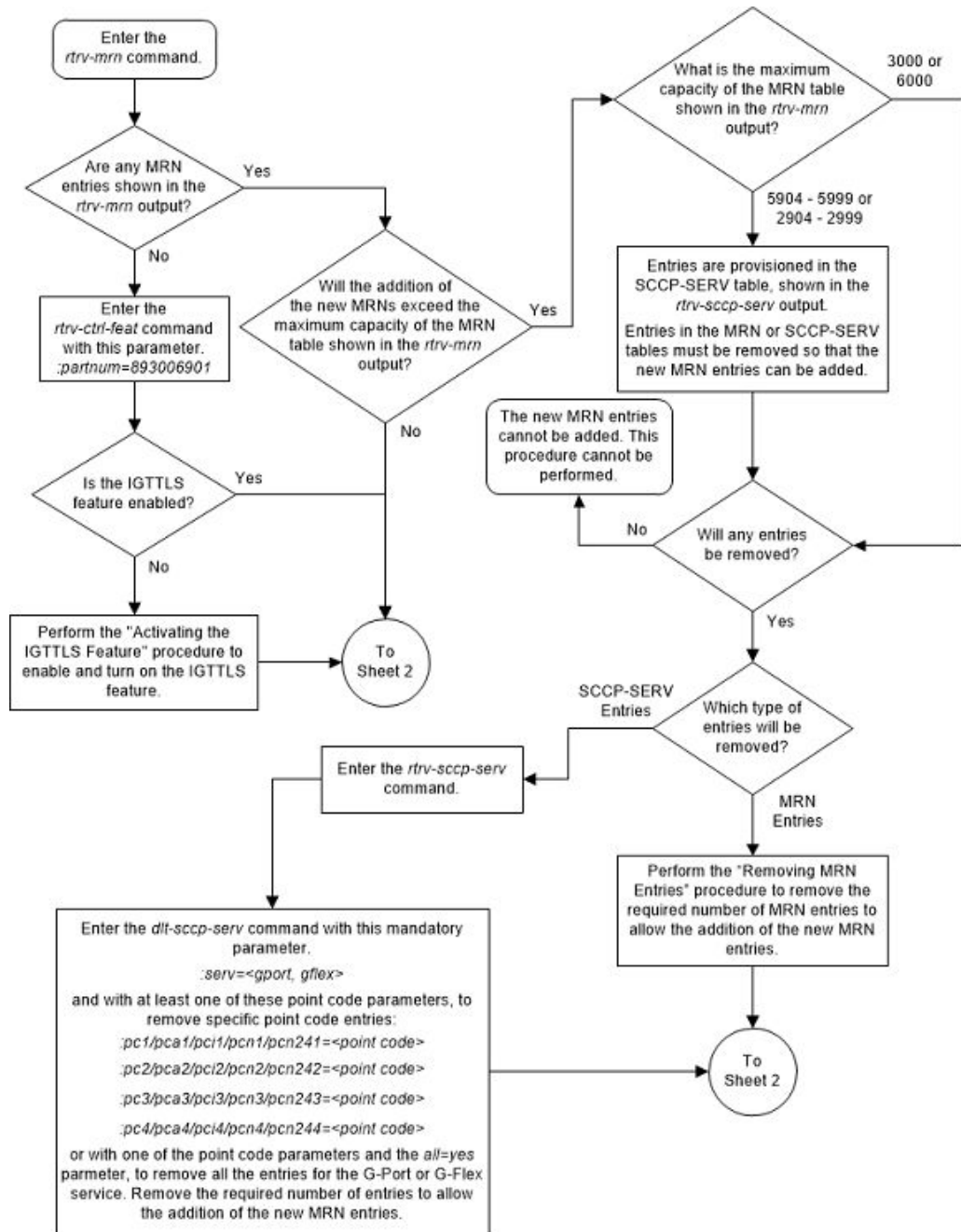

Figure 2-131 Provision MRN Entries - Sheet 2 of 5

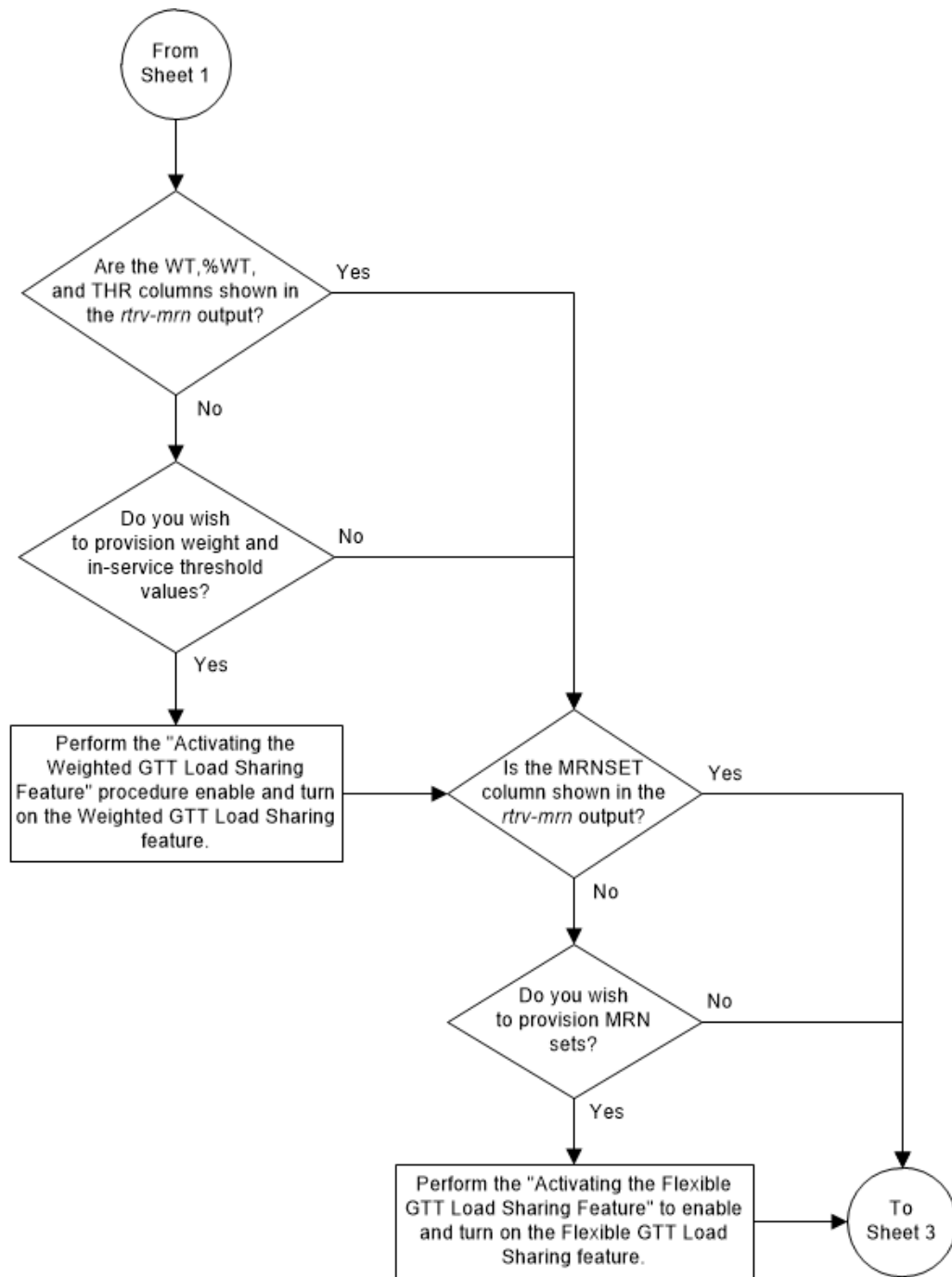

Figure 2-132 Provision MRN Entries - Sheet 3 of 5

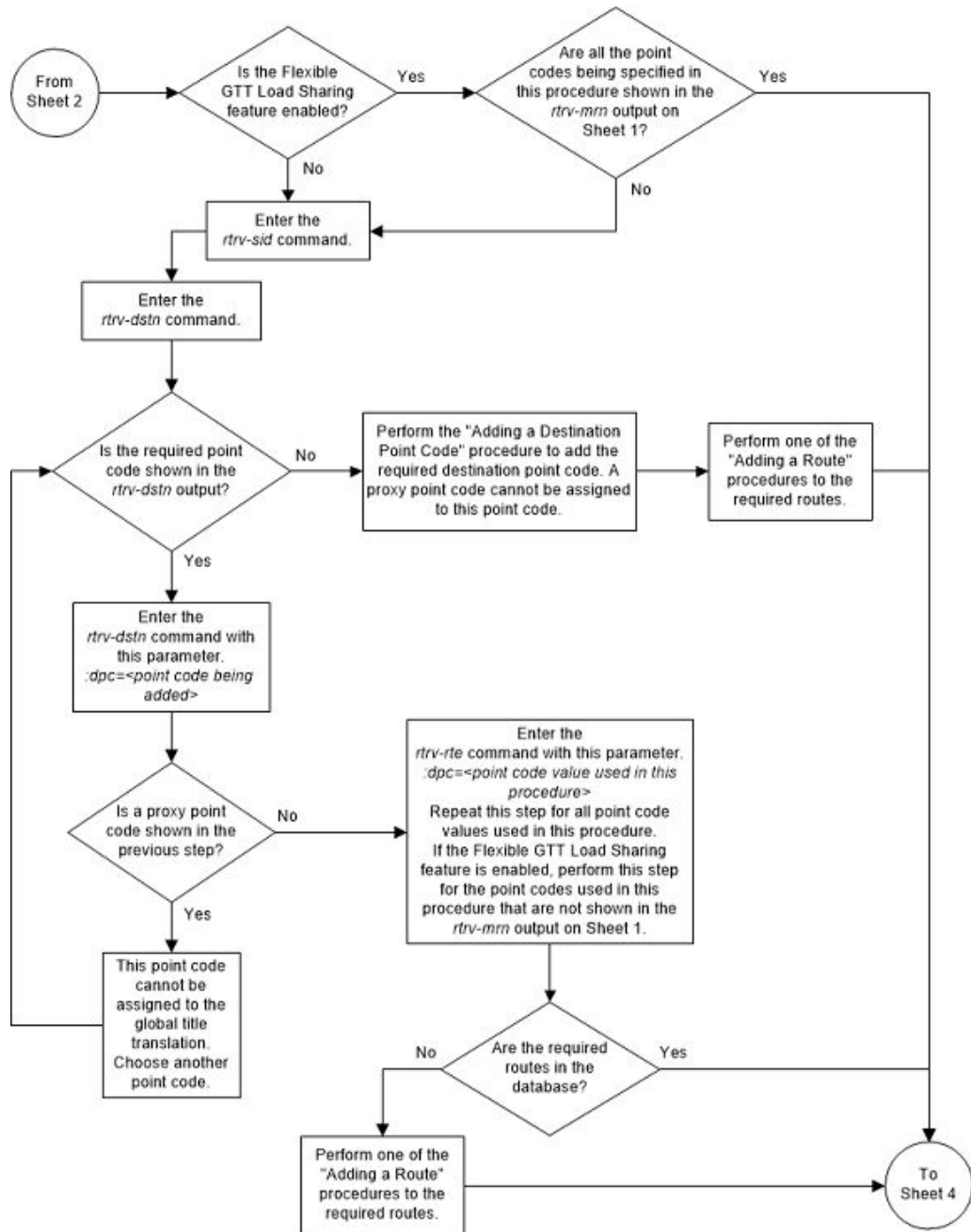

Figure 2-133 Provision MRN Entries - Sheet 4 of 5

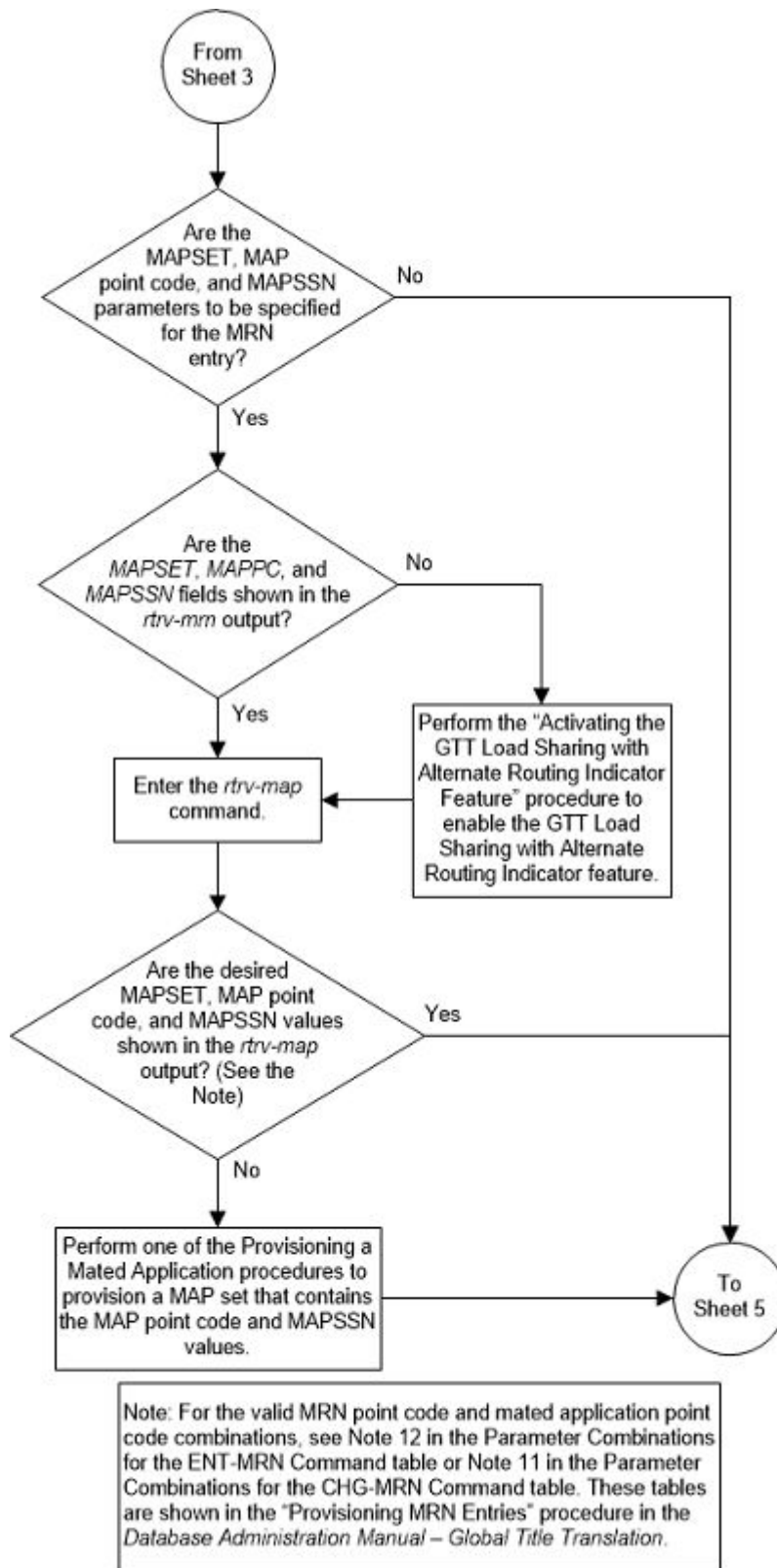
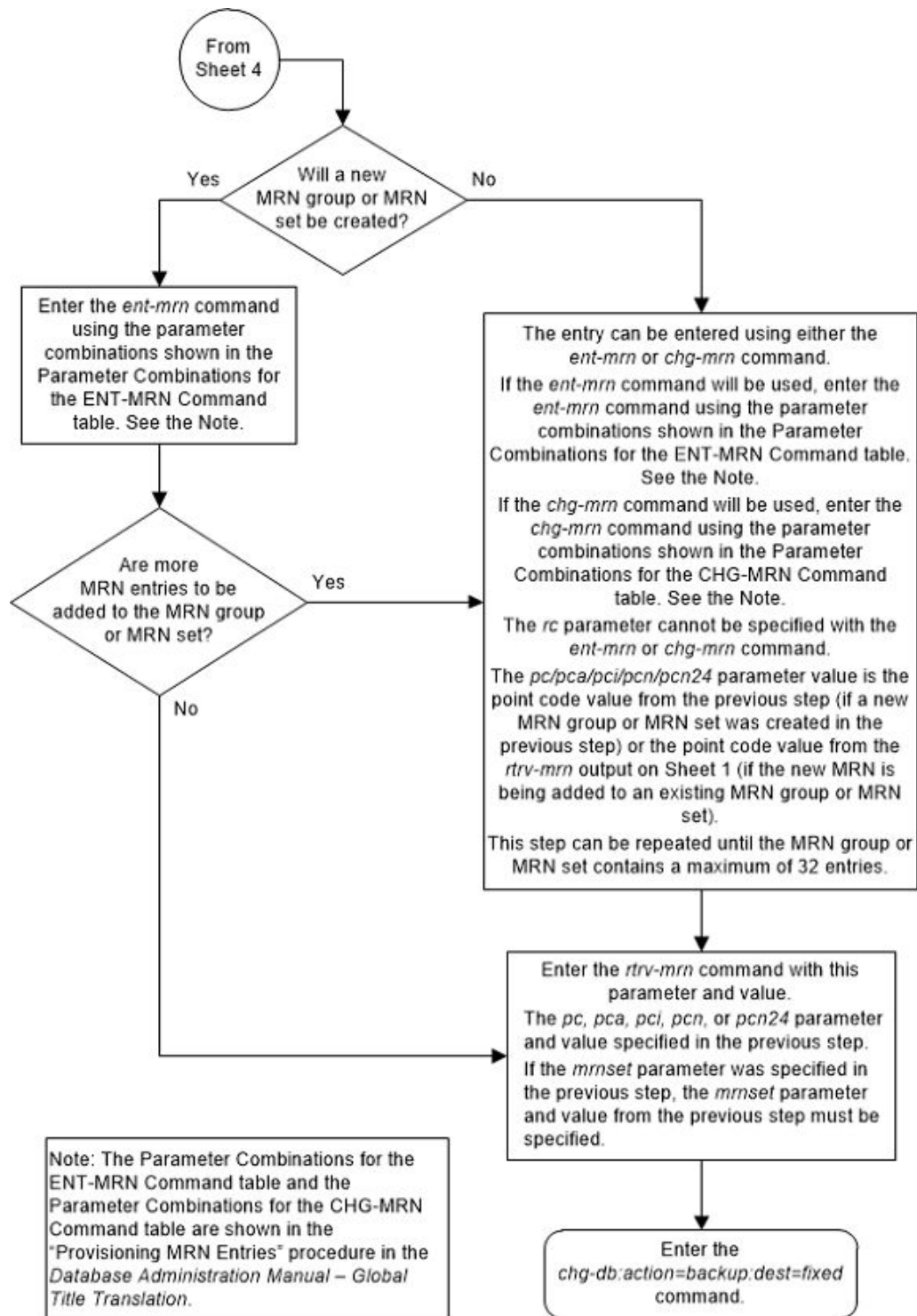

Figure 2-134 Provision MRN Entries - Sheet 5 of 5



Removing MRN Entries

This procedure is used to remove an entry from an mated relay node (MRN) group or an entire MRN group from the database using the `dlr-mrn` command.

The `dlt-mrn` command uses these parameters.

`:pc/pca/pci/pcn/pcn24` – The point code in the message after intermediate global title translation has been performed.

`:pc1/pca1/pci1/pcn1/pcn241` – The first alternate point code value

`:pc2/pca2/pci2/pcn2/pcn242` – The second alternate point code value

`:pc3/pca3/pci3/pcn3/pcn243` – The third alternate point code value

`:pc4/pca4/pci4/pcn4/pcn244` – The fourth alternate point code value

**Note:**

Refer to Chapter 2, "Configuring Destination Tables," in *Database Administration - SS7 User's Guide* for a definition of the point code types that are used on the EAGLE and for a definition of the different formats that can be used for ITU national point codes.

`:all` – Removes the entire MRN group or MRN set containing the point code specified by the `pc/pca/pci/pcn/pcn24` parameter.

`:mrnset` – The MRN set ID that the MRN is assigned to, shown in the `rtrv-mrn` output. MRN set IDs are shown only if the Flexible GTT Load Sharing feature is enabled. If the Flexible GTT Load Sharing feature is enabled, the `mrnset` parameter must be specified with the `dlt-mrn` command.

`:mapset` – The MAP set ID assigned to the MRN set. This is the MAP set from which alternate routing indicator searches are performed. The `mapset` parameter is shown in the `rtrv-mrn` output only if the GTT Load Sharing with Alternate Routing Indicator feature is enabled. An MRN set or a point code in an MRN set cannot be removed if a MAP set is assigned to the MRN set.

If an entire MRN set is being removed in this procedure (with the `all=yes` parameter), or if a point code entry in an MRN set is being removed in this procedure, the reference to the MRN set specified in this procedure must be removed from any GTT or GTA entries before the point code can be removed from an MRN set, or before an entire MRN set can be removed.

Perform one of these procedures to remove the reference to the MRN set, depending on whether or not the EGTT feature is on. The status of the EGTT feature is shown in the `rtrv-feat` command output.

- If the EGTT feature is not on – Enter the `rtrv-gtt` command to verify the MRN set ID references. Perform the [Changing a Global Title Translation](#) procedure to remove the references to the MRN set.
- If the EGTT feature is on – Enter the `rtrv-gta` command to verify the MRN set ID references. Perform [Changing Global Title Address Information](#) to remove the references to the MRN set. The MRN set ID is not shown in the `rtrv-ppsopt` output.
- Any references to the MRN's point code and non-default MRN set ID in the `rtrv-ppsopts` output are removed in 9 of this procedure.

- Any references to the MRN's point code and non-default MRN set ID in the `rtrv-gttact` output are removed in 10 of this procedure.

 **Note:**

If weight and in-service threshold values are assigned to a load shared or combined dominant/load shared MRN group or MRN set, and if by removing entries from this MRN group or MRN set, the MRN group or MRN set becomes a dominant MRN group or MRN set, all weight and threshold values are removed from the remaining entries in the MRN group or MRN set.

The mated relay node group being removed, or the point code value being removed from a MRN group must be in the database.

When removing point codes from an MRN group, the MRN group must contain the `pc` parameter value and at least one alternate point code value.

If the `mrnset=dflt` and `all=yes` parameters are specified with the `dlt-mrn` command, only the MRN group containing the point code value specified in the `dlt-mrn` command is removed from the default MRN set.

Canceling the RTRV-MRN Command

Because the `rtrv-mrn` command used in this procedure can output information for a long period of time, the `rtrv-mrn` command can be canceled and the output to the terminal stopped. There are three ways that the `rtrv-mrn` command can be canceled.

- Press the F9 function key on the keyboard at the terminal where the `rtrv-mrn` command was entered.
- Enter the `canc-cmd` without the `trm` parameter at the terminal where the `rtrv-mrn` command was entered.
- Enter the `canc-cmd:trm=<xx>`, where `<xx>` is the terminal where the `rtrv-mrn` command was entered, from another terminal other than the terminal where the `rtrv-mrn` command was entered. To enter the `canc-cmd:trm=<xx>` command, the terminal must allow Security Administration commands to be entered from it and the user must be allowed to enter Security Administration commands. The terminal's permissions can be verified with the `rtrv-secu-trm` command. The user's permissions can be verified with the `rtrv-user` or `rtrv-secu-user` commands.

For more information about the `canc-cmd` command, refer to *Commands User's Guide*.

1. Display the mated relay nodes in the database using the `rtrv-mrn` command.

This is an example of the possible output.

```
rlghncxa03w 09-02-07 00:34:31 GMT EAGLE5 40.1.0
```

MRNSET	MAPSET	MAPP	MAPSSN	PC	RC	WT
%WT	THR					
DFLT	7	002-002-007	50	005-005-005	10	10

```

50 30
                                006-001-001  10 10
50 30
                                006-001-002  30 20
100 30
                                006-001-003  40 20
100 30
                                006-001-004  50 20
100 30

      MRNSET MAPSET  MAPPC          MAPSSN    PC          RC WT
%WT THR
  1      5      255-001-002      252      005-005-005  10 10
4      1
                                006-001-001  10 10
4      1
                                006-001-002  10 30
12     1
                                006-001-003  10 40
15     1
                                006-001-005  10 40
15     1
                                006-001-006  10 40
15     1
                                006-001-007  10 40
15     1
                                006-001-004  10 50
19     1
                                006-001-008  20 20
25     1
                                006-001-009  20 30
37     1
                                006-001-010  20 30
37     1

```

MRN table is (16 of 5990) 1% full

 **Note:**

If the Weighted GTT Load Sharing feature is not enabled and turned on, the WT, %WT, THR columns and values are not shown in the `rtrv-mrn` output.

Continue the procedure by performing one of these steps.

- If the MRNSET column is not shown in the `rtrv-mrn` output, then the Flexible GTT Load Sharing feature is not enabled. Continue the procedure with [11](#).
- If only the MRNSET column is shown in the `rtrv-mrn` output, continue the procedure with [4](#).
- If the MRNSET and MAPSET columns are shown in the `rtrv-mrn` output, continue the procedure by performing one of these steps.

- If an entire MRN set is being removed, continue the procedure with 3.
- If a point code entry is being removed from the MRN set, continue the procedure with 4.
- If the MAP set entry is being removed from the MRN set, continue the procedure with 2.

 **Note:**

If the `MAPSET` column contains dashes, then a MAP set is not assigned to the MRN set.

2. Remove the MAP set from the MRN set using the `dlt-mrn` command with the `mrnset`, `mapset`, and `pc/pca/pci/pcn/pcn24` parameters and values shown in 1. For this example, enter this command.

```
dlt-mrn:mrnset=1:mapset=5:pca=005-005-005
```

This message should appear.

```
rlghncxa03w 09-02-07 11:48:16 GMT EAGLE5 40.1.0
DLT-MRN: MASP A - COMPLTD
```

If you wish to remove any point code entries from the MRN set, continue the procedure with 4.

If you do not wish to remove any point code entries from the MRN set, continue the procedure with 12.

3. Display the mated applications by entering the `rtrv-map` command. This is an example of the possible output.

```
rlghncxa03w 09-07-07 00:34:31 GMT EAGLE5 41.1.0
```

```
MAPSET ID=DFLT   MRNSET ID=---- MRNPC   =   -----
PCA              Mate PCA      SSN RC MULT SRM MRC GRP NAME SSO
255-001-000                250 10 SOL *Y *Y grp01  ON
```

```
MAPSET ID=1     MRNSET ID=1     MRNPC   =   005-005-005
PCA              Mate PCA      SSN RC MULT SRM MRC GRP NAME SSO
255-001-000                251 10 SHR *Y *Y grp01  OFF
                253-001-002  254 10 SHR *Y *Y grp01  OFF
```

```
MAPSET ID=2     MRNSET ID=DFLT MRNPC   =   005-005-005
PCA              Mate PCA      SSN RC MULT SRM MRC GRP NAME SSO
255-001-000                252 10 SOL *Y *Y grp01  ON
```

```
MAPSET ID=DFLT   MRNSET ID=---- MRNPC   =   -----
PCA              Mate PCA      SSN RC MULT SRM MRC GRP NAME SSO
255-001-000                253 10 SHR *Y *Y grp01  OFF
                253-001-004  254 10 SHR *Y *Y grp01  OFF
```

```
MAPSET ID=3     MRNSET ID=---- MRNPC   =   -----
PCA              Mate PCA      SSN RC MULT SRM MRC GRP NAME SSO
255-001-001                255 10 DOM YES YES grp01  ON
```

```

                253-001-005  254 20  DOM YES YES grp01    ON

MAPSET ID=4      MRNSET ID=---- MRNPC = -----
PCA             Mate PCA      SSN RC MULT SRM MRC GRP NAME SSO
255-001-001     253-001-001  254 20  DOM YES YES grp01    OFF
                253-001-001  254 20  DOM YES YES grp01    OFF

MAPSET ID=DFLT  MRNSET ID=---- MRNPC = -----
PCA             Mate PCA      SSN RC MULT SRM MRC GRP NAME SSO
255-001-002     255-001-002  251 10  SHR *Y *Y  grp01    OFF
                255-001-002  254 10  SHR *Y *Y  grp01    OFF

MAPSET ID=5      MRNSET ID=---- MRNPC = -----
PCA             Mate PCA      SSN RC MULT SRM MRC GRP NAME SSO
255-001-002     255-001-003  252 10  DOM YES YES grp01    ON
                255-001-003  254 20  DOM YES YES grp01    ON

MAPSET ID=6      MRNSET ID=---- MRNPC = -----
PCA             Mate PCA      SSN RC MULT SRM MRC GRP NAME SSO
255-001-002     255-001-004  253 10  SHR *Y *Y  grp01    ON
                255-001-004  254 10  SHR *Y *Y  grp01    ON

MAPSET ID=7      MRNSET ID=---- MRNPC = -----
PCA             Mate PCA      SSN RC MULT SRM MRC GRP NAME SSO
002-002-007     002-002-008  50 10  COM YES *Y  grp01    OFF
                002-002-008  30 10  COM YES *Y  grp01    OFF
                002-002-009  30 10  COM YES *Y  grp01    OFF
                002-002-010  30 20  COM YES *Y  grp01    OFF
                002-002-011  30 20  COM YES *Y  grp01    OFF

MAPSET ID=8      MRNSET ID=---- MRNPC = -----
PCI             Mate PCI      SSN RC MULT SRM MRC GRP NAME SSO
2-001-2         2-001-1      255 10  DOM NO  YES grp03    OFF
                2-001-1      254 20  DOM NO  YES grp03    OFF

MAPSET ID=9      MRNSET ID=---- MRNPC = -----
PCN             Mate PCN      SSN RC MULT SRM MRC GRP NAME SSO
00347          01387       253 10  SHR *N *N  grp05    OFF
                01387       254 10  SHR *N *N  grp05    OFF

MAP TABLE IS (25 of 36000) 1 % FULL

```

If the MRN set is not assigned to any MAP sets, continue the procedure with 4.

If the MRN set is assigned to any MAP sets, perform [Removing a Mated Application](#) to remove the MRN set from the MAP sets. After the MRN set has been removed from the MAP sets, continue the procedure with 4.

4. Verify whether or not the Enhanced GTT feature is on by entering the `rtrv-feat` command.

If the EGTT feature is on, the EGTT field should be set to `on`.

 **Note:**

The `rtrv-feat` command output contains other fields that are not used by this procedure. If you wish to see all the fields displayed by the `rtrv-feat` command, refer to the `rtrv-feat` command description in *Commands User's Guide*.

If the EGTT feature is on, continue the procedure with 7.
If the EGTT feature is off, continue the procedure with 5.

5. Display the translation types in the database by entering the `rtrv-tt` command.

This is an example of the possible output.

```
rlghncxa03w 07-05-25 09:42:31 GMT EAGLE5 37.0.0
TYPEA      TTN      NDGT
1          lidb     5
2          c800    10
3          d700    6
5          scp1   6
10         scp2   6
15         scp3   3

ALIAS      TYPEA
30         5
40         10
50         3
65         3

TYPEI      TTN      NDGT
105       itudb    8

ALIAS      TYPEI
7         105

TYPEN      TTN      NDGT
120       dbitu   7

ALIAS      TYPEN
8         120
```

6. Before an MRN set can be removed from the database, or a point code entry can be removed from an MRN set, all references to the specific MRN set must be removed from the global title translations.

Select a translation type from 5 . Display the global title translations assigned to the translation type from 5 that contain either the point code being removed from the MRN set, or a point code in the MRN set that is being removed in this procedure.

For this example, enter this command.

```
rtrv-gtt:typea=15:pca=006-001-002
```

This is an example of the possible output.

```
rlghncxa03w 08-10-25 09:48:31 GMT EAGLE5 39.2.0
TYPEA TTN NDGT
15 scp3 3
GTT TABLE IS 10 % FULL (27000 of 269999)
```

```
START GTA END GTA XLAT RI PC
800 900 DPC GT
006-001-002
MRNSET=1 SSN=--- NGT=---
```

Command Retrieved 1 Entries

If entries are displayed, perform the [Changing a Global Title Translation](#) procedure and change the MRN reference to `NONE`, or remove the global title translation by performing the [Removing a Global Title Translation](#) procedure.

If no entries are displayed, repeat this step with the other translation types displayed in [5](#).

When all the translation types have been displayed and all applicable global title translation entries have been changed or removed in this step, continue the procedure with [9](#).

7. Display the existing GTT sets in the database using the `rtrv-gttset` command.

This is an example of the possible output.

```
rlghncxa03w 09-07-07 00:27:31 GMT EAGLE5 41.1.0
GTTSN NETDOM NDGT
lidb ansi 10
t800 ansi 10
si000 itu 15
imsi itu 15
abcd1234 itu 12
```

GTT-SET table is (5 of 2000) 1% full.

8. Before an MRN set can be removed from the database, all references to the specific MRN set must be removed from the global title translations displayed in the `rtrv-gta` output. Before a point code entry can be removed from an MRN set, all references to the specific MRN set must be removed from the global title translations displayed in the `rtrv-gta` output.

Select a GTT set name from [7](#). Display the global title translations assigned to the GTT set name from [7](#) that contain either the point code being removed from the MRN set, or a point code in the MRN set that is being removed in this procedure.

For this example, enter this command.

```
rtrv-gta:gttsn=t800:pca=006-001-002
```

This is an example of the possible output.

```
rlghncxa03w 10-07-07 00:27:31 GMT EAGLE5 42.0.0
GTTSN NETDOM SETTYPE NDGT
```

```
t800      ansi    CDGTA    10
GTA TABLE IS 1 % FULL (17 of 269999)

START GTA  END GTA    XLAT  RI    PC
8005550000 8005551999 dpcssn gt    006-001-002
MRNSET=1    SSN=50    CCGT=no CGGTMOD=NO
GTMODID=----- TESTMODE=off
OPTSN=----- CGSELID=----- OPCS=-----
ACTSN=act10    PPMEASREQD= NO
```

Command Retrieved 1 Entries

If entries are displayed, perform [Changing Global Title Address Information](#) and change the MRN reference to `NONE`, or remove the entry by performing the [Removing Global Title Address Information](#) procedure.

If no entries are displayed, repeat this step with the other GTT set names displayed in 7 .

When all the GTT set names have been displayed and all applicable global title translation entries have been changed or removed in this step, continue the procedure with 9.



Note:

If the MRN being removed is in the default MRN set, continue the procedure with 11.

- The MRN cannot be removed if the point code and non-default MRN set ID of the MRN is shown in the `rtrv-ppsopts` command output. Enter the `rtrv-ppsopts` command to verify that the MRN's point code and non-default MRN set ID is not shown in the `rtrv-ppsopts` output. This is an example of the possible output.

```
rlghncxa03w 09-03-20 09:07:58 GMT EAGLE5 40.1.0
Prepaid SMS Options
-----
BPARTYCHK      = OFF
PPT            PCA/PCI/PCN                SSN      RI      Set ID
---            -
1             PCI:    1-001-1                25       SSN     DFLT
2             -----                NONE     GT      DFLT
3             -----                NONE     GT      DFLT
4             PCI:    1-001-1                30       GT      1
5             -----                NONE     GT      DFLT
6             -----                NONE     GT      DFLT
7             -----                NONE     GT      DFLT
8             PCI:    1-001-1                75       SSN     1
9             -----                NONE     GT      DFLT
10            -----                NONE     GT      DFLT
11            -----                NONE     GT      DFLT
12            -----                NONE     GT      DFLT
13            -----                NONE     GT      DFLT
14            -----                NONE     GT      DFLT
15            -----                NONE     GT      DFLT
```

If the `rtrv-ppsopts` output shows any entries that reference the MRN's point code and non-default MRN set ID, remove the reference using the `chg-ppsopts` command with the prepaid portability type (the `PPT` value) that contains the reference and either the `pci=none` or `pcn=none` parameters (depending on the type of point code the prepaid portability type contains).

```
chg-ppsopts:ppt=8:pci=none
```

This is an example of the possible output.

```
rlghncxa03w 07-05-20 09:07:58 GMT EAGLE5 37.0.0
CHG-PPSOPTS: MASP A - COMPLTD
```

Repeat this step for other entries shown in the `rtrv-ppsopts` output that contain the MRN's point code and non-default MRN set ID.

10. The MRN cannot be removed if the point code and non-default MRN set ID of the MRN is shown in the `rtrv-gttact` command output. Enter the `rtrv-gttact` command to verify that the MRN's point code and non-default MRN set ID is not shown in the `rtrv-gttact` output. For this example, enter this command.

```
rtrv-gttact:pca=006-001-002:mrnset=1
```

This is an example of the possible output.

```
rlghncxa03w 10-07-20 09:07:58 GMT EAGLE5 42.0.0
```

ACTID	ACTION	PCA	RI	SSN	MRNSET	MAPSET
action3	dup	006-001-002	gt	---	1	-----
		CDGTMODID = -----			CGGTMODID = -----	
		USEICMSG = off			CGPCOGMSG = dflt	CGPCA = ---

```
GTT-ACT table is (3 of 2000) 1% full.
```

If the `rtrv-gttact` output shows any entries that reference the MRN's point code and non-default MRN set ID, performing the [Changing a GTT Action](#) procedure to change the MRN set that is referenced in the GTT action to reference another MRN set or to reference no MRN set.

Repeat this step for other entries shown in the `rtrv-gttact` output that contain the MRN's point code and non-default MRN set ID.

11. Remove the mated relay node from the MRN group or MRN set using the `dlt-mrn` command with a point code from the `rtrv-mrn` command output shown in [1](#) . For this example, enter this command.

 **Note:**

If the MRNSET column is shown in the `rtrv-mrn` output in [1](#), then the `mrnset` parameter must be specified with the `dlt-mrn` command. The `mrnset` parameter value must be the MRN set ID containing the point code specified in this step. If the MRNSET column is not shown in the `rtrv-mrn` output in [1](#), the `mrnset` parameter cannot be specified with the `dlt-mrn` command.

For this example, enter this command.

```
dlt-mrn:pca=006-001-002:mrnset=1
```

 **Note:**

If the entire MRN group or MRN set is not being removed in this step, the MRN group or MRN set must contain at least two entries after this step is performed.

This message should appear.

```
rlghncxa03w 07-05-07 11:48:16 GMT EAGLE5 37.0.0  
DLT-MRN: MASP A - COMPLTD
```

 **Note:**

If the MRNSET column is not shown in [1](#) and an entire MRN group is being removed from the database, enter the `dlt-mrn` command with the point code and the `all=yes` parameter. For this example, enter the `dlt-mrn:pca=006-001-002:all=yes` command.

 **Note:**

If the MRNSET column is shown in [1](#) and an entire MRN set is being removed from the database, enter the `dlt-mrn` command with the point code, the `mrnset` parameter value containing a point code in the MRN set, and the `all=yes` parameter. For this example, enter the `dlt-mrn:pca=006-001-002:mrnset=1:all=yes` command. If the `mrnset=df1t` and `all=yes` parameters are specified with the `dlt-mrn` command, only the MRN group containing the point code value specified in the `dlt-mrn` command is removed from the default MRN set.

 **Note:**

If weight and in-service threshold values are assigned to a load shared or combined dominant/load shared MRN group or MRN set, and if by removing entries from this MRN group or MRN set, the MRN group or MRN set becomes a dominant MRN group or MRN set, all weight and threshold values are removed from the remaining entries in the MRN group or MRN set.

12. Verify the changes using the `rtrv-mrn` command with the point code specified in 2 or 11.

If the `mrnset` parameter was specified in 11, the `mrnset` parameter and the `mrnset` parameter value specified in 11 must be specified in this step. For this example, enter this command.

```
rtrv-mrn:pca=006-001-002:mrnset=1
```

This message should appear.

```
E4483 Cmd Rej: PC does not exist in specified MRNSET
```

 **Note:**

When an entire MRN group is removed from the default MRN set, this message, E4483, will appear when the `rtrv-mrn` command is specified with the `mrnset=deflt` and the point code value specified in 11.

If an entire MRN set was removed in 11, the following message appears when this step is performed.

```
E4480 Cmd Rej: Specified MRNSET does not exist
```

If the Flexible GTT Load Sharing feature is not enabled, the `mrnset` parameter cannot be specified with the `rtrv-mrn` command. When this step is performed (without the Flexible GTT Load Sharing feature enabled and without the `mrnset` parameter), the following message appears.

```
E2849 Cmd Rej: PC must already exist in the MRN table
```

If the MAP set was removed from the MRN set in 2, enter the `rtrv-mrn` command with the `mrnset` and point code parameters and values specified in 2. For this example, enter this command.

```
rtrv-mrn:mrnset=1:pca=005-005-005
```

This is an example of the possible output.

```
rlghncxa03w 09-02-07 00:34:31 GMT EAGLE5 40.1.0
```

```
MRNSET MAPSET  MAPPC          MAPSSN      PC          RC WT
%WT THR
```

```

    1      -----
4  1
    4  1
    12  1
    15  1
    15  1
    15  1
    15  1
    15  1
    19  1
    25  1
    37  1
    37  1
  
```

MRN table is (16 of 5990) 1% full

- Backup the new changes using the `chg-db:action=backup:dest=fixed` command.

These messages should appear, the active Maintenance and Administration Subsystem Processor (MASP) appears first.

```

BACKUP (FIXED) : MASP A - Backup starts on active MASP.
BACKUP (FIXED) : MASP A - Backup on active MASP to fixed disk
complete.
BACKUP (FIXED) : MASP A - Backup starts on standby MASP.
BACKUP (FIXED) : MASP A - Backup on standby MASP to fixed disk
complete.
  
```

Figure 2-135 Remove MRN Entries - Sheet 1 of 6

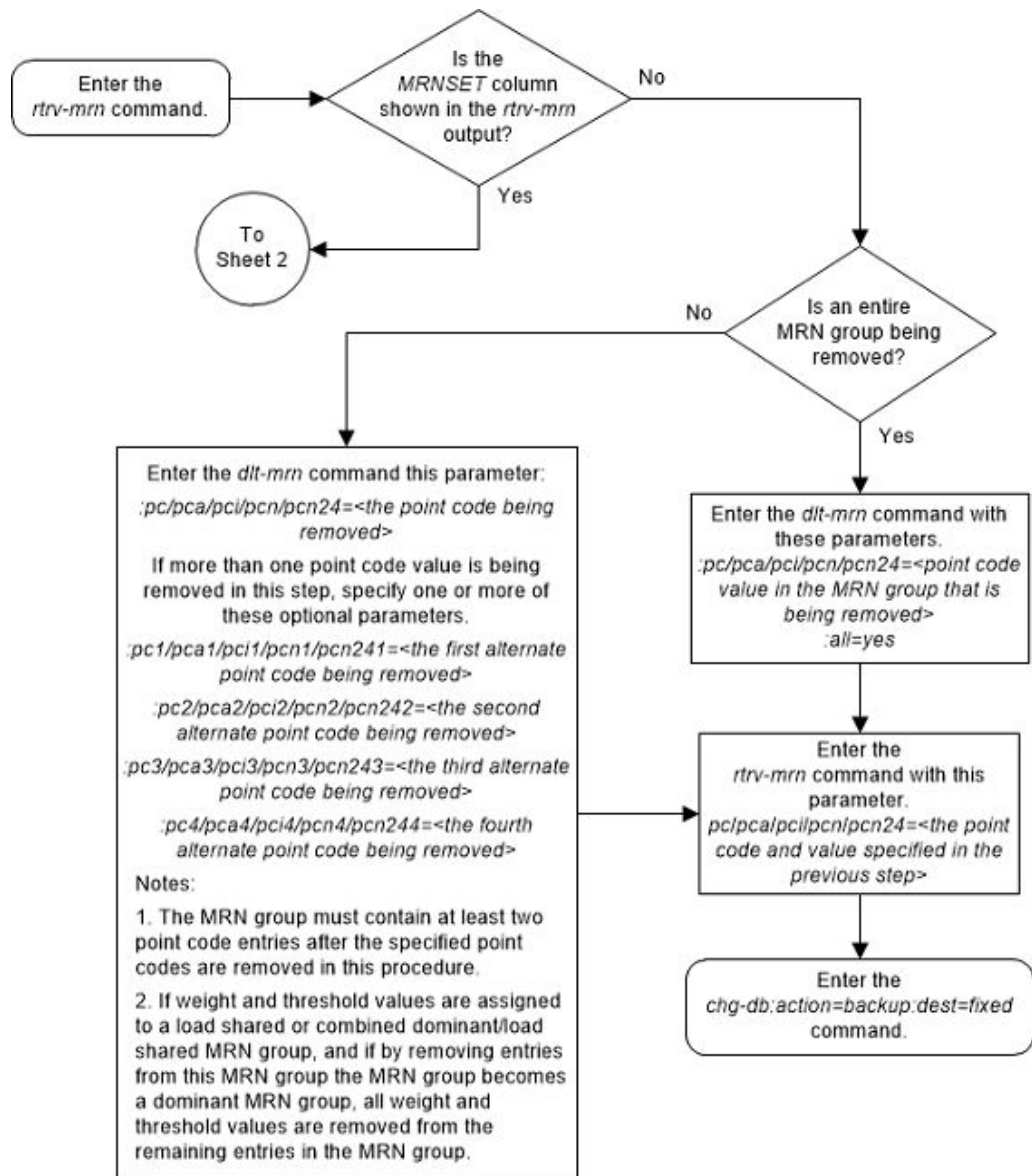

Figure 2-136 Remove MRN Entries - Sheet 2 of 6

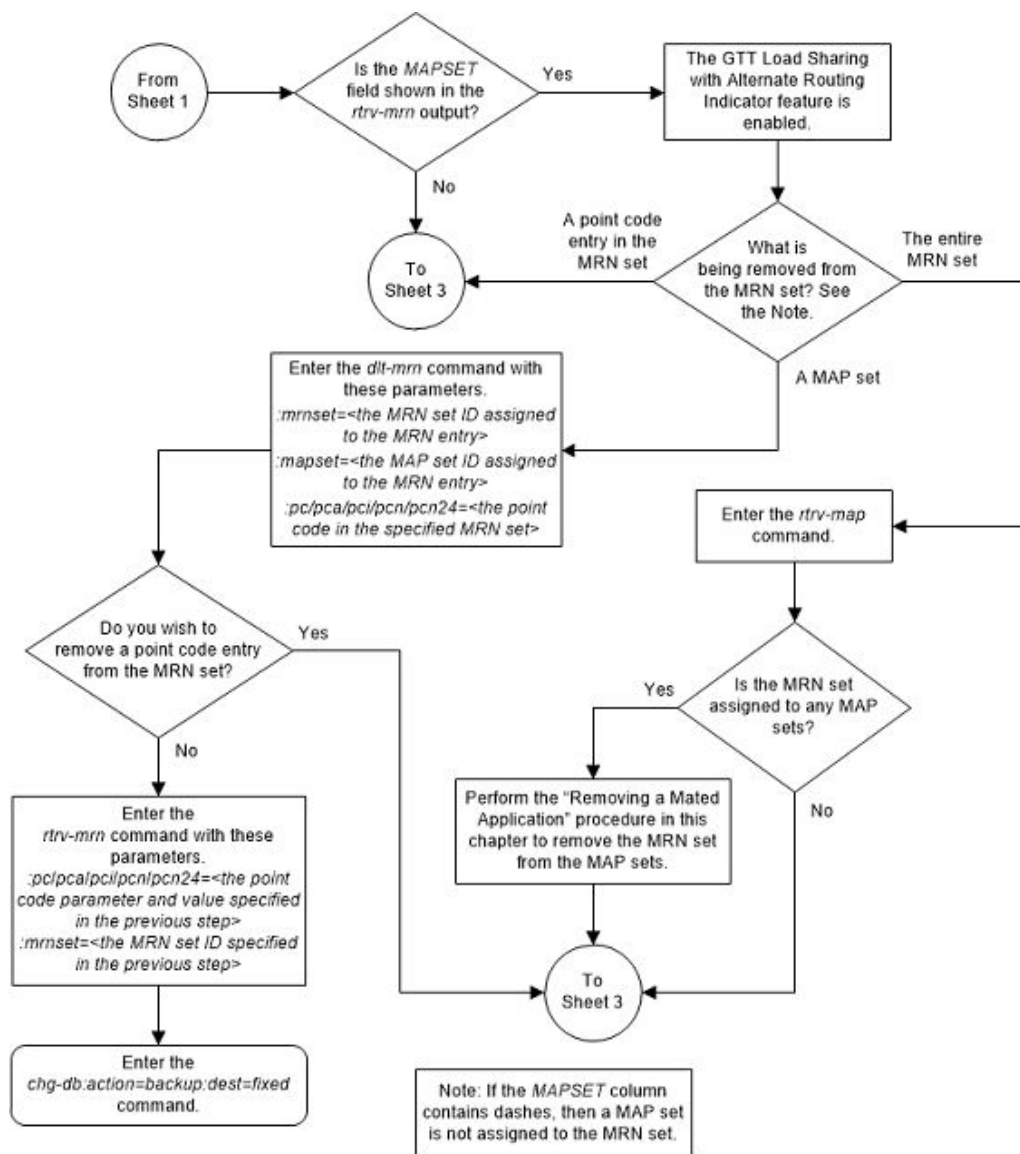

Figure 2-137 Remove MRN Entries - Sheet 3 of 6

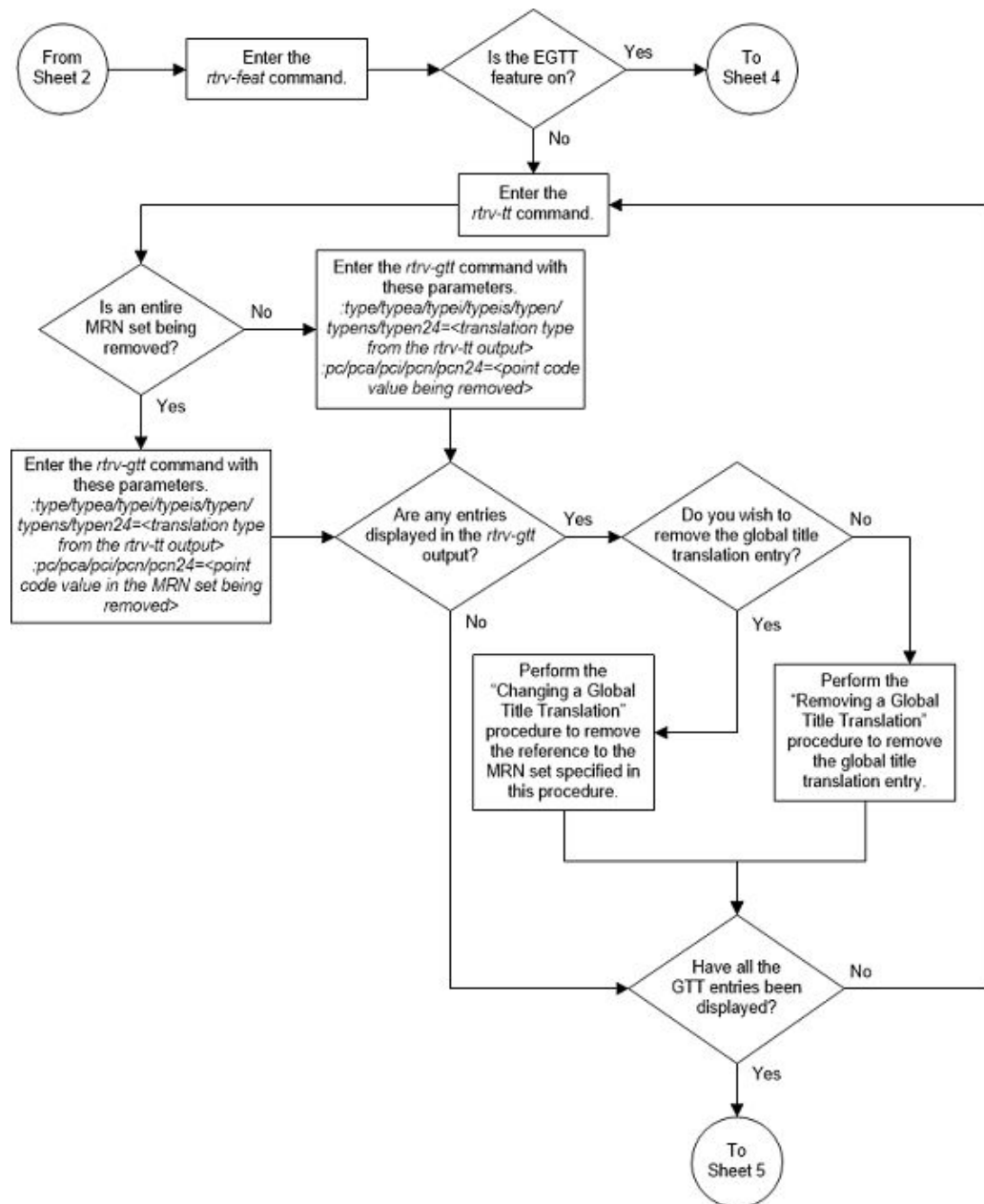

Figure 2-138 Remove MRN Entries - Sheet 4 of 6

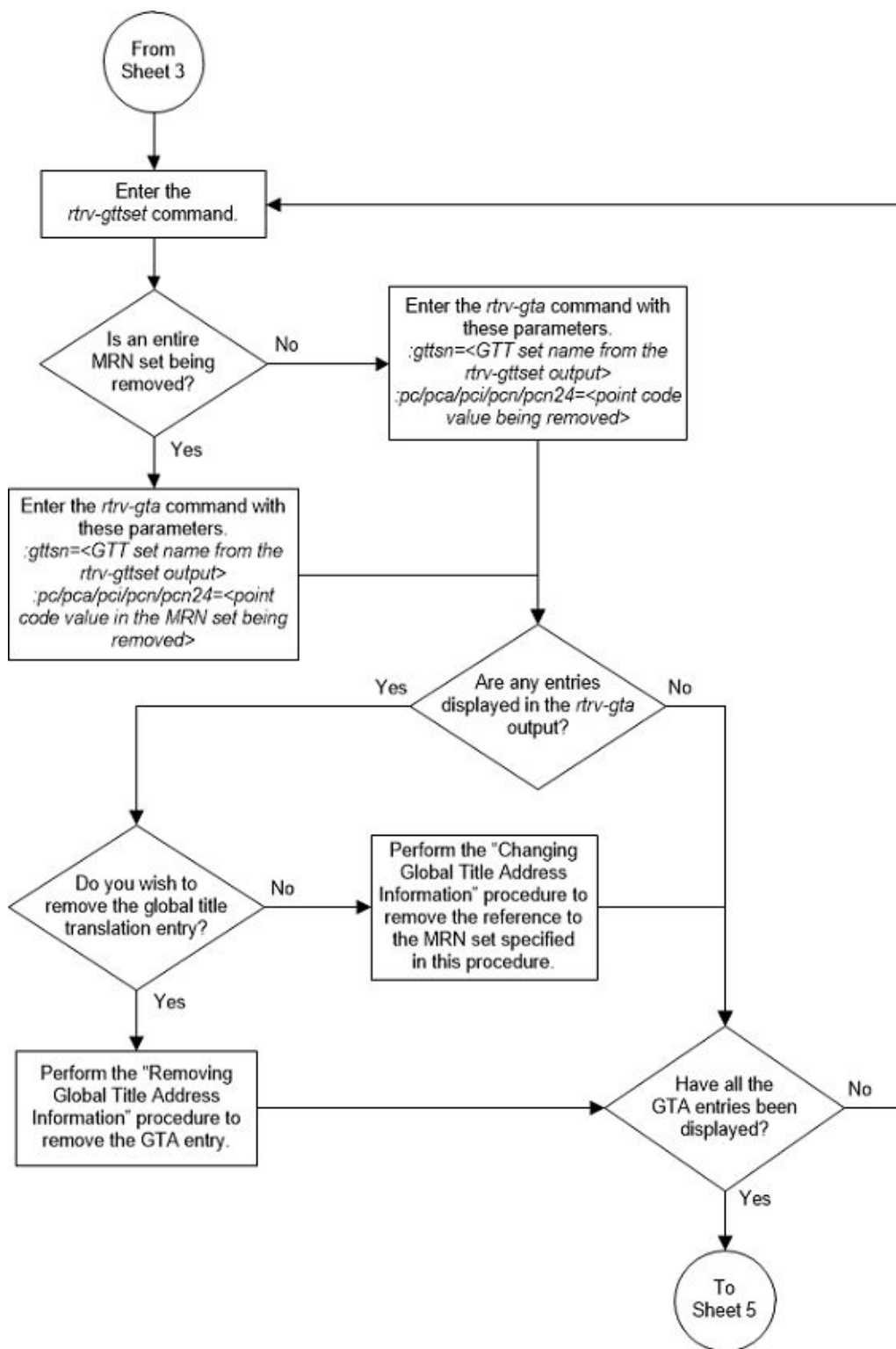

Figure 2-139 Remove MRN Entries - Sheet 5 of 6

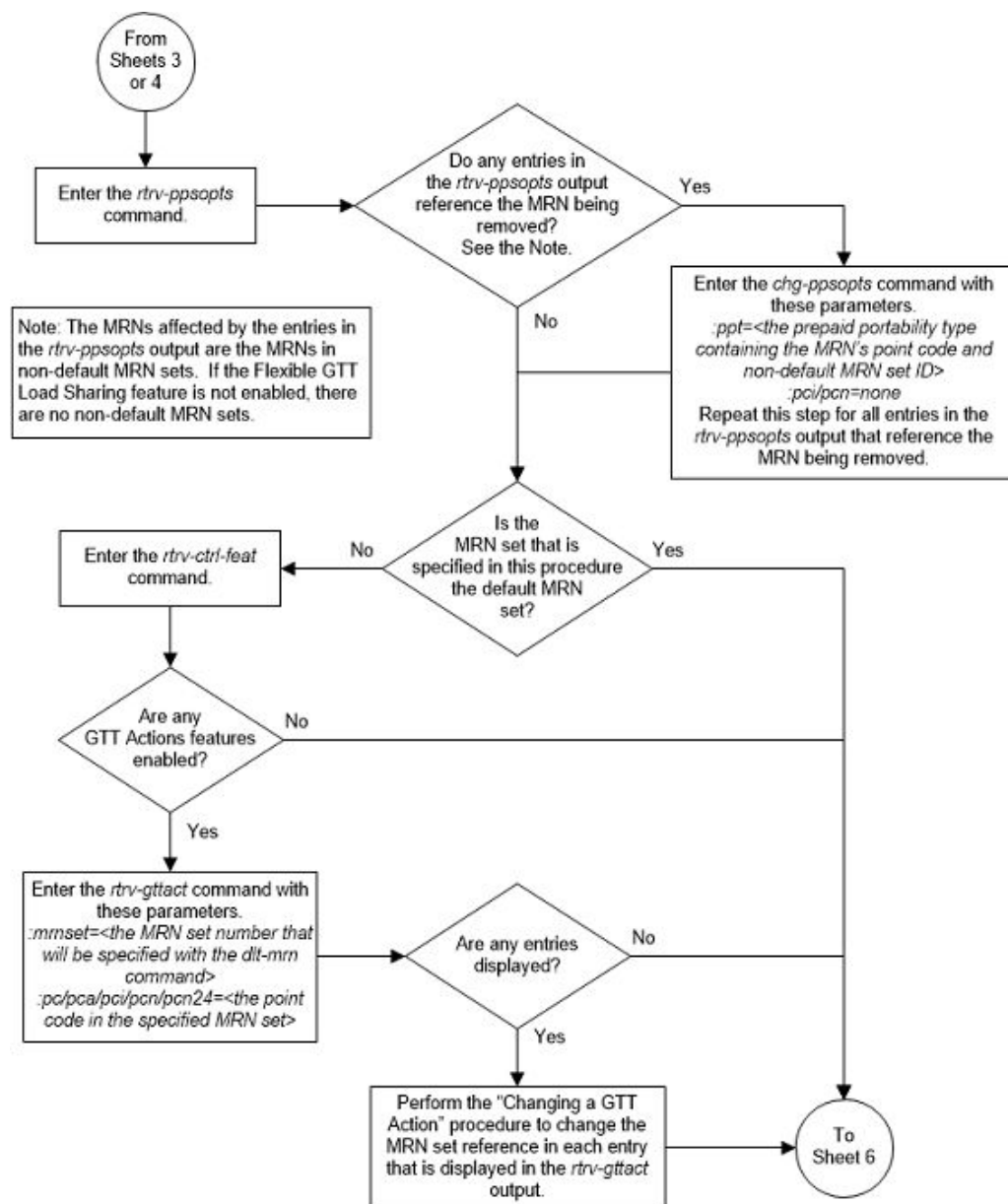
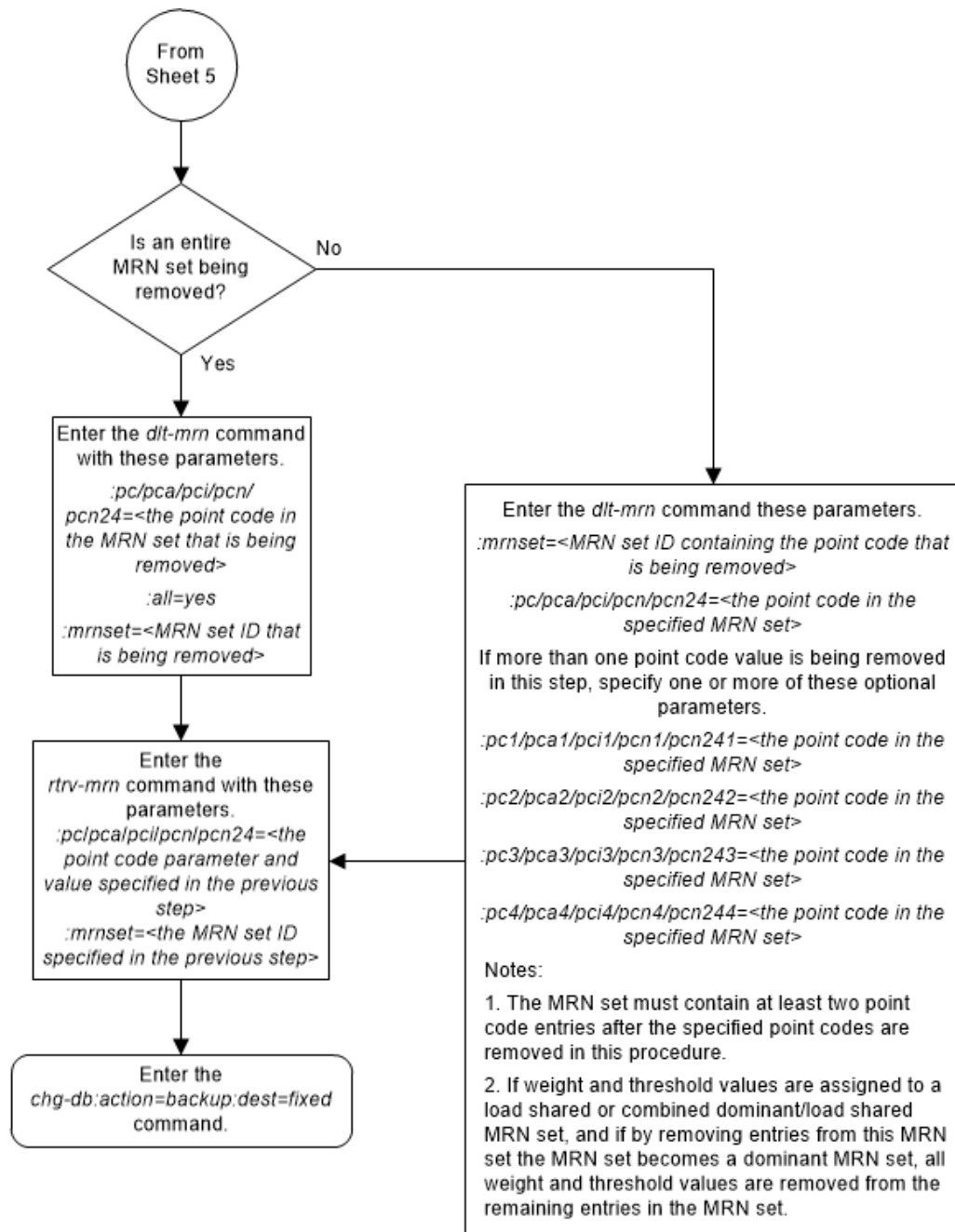

Figure 2-140 Remove MRN Entries - Sheet 6 of 6



Changing the Relative Cost Values of MRN Entries

This procedure is used to change the relative cost attributes of entries in an existing Mated Relay Node (MRN) group or MRN set using *rc/rc1/rc2/rc3/rc4* parameters of the *chg-mrn* command.

The *chg-mrn* command can also be used to add point code entries to an existing MRN group or MRN set. This action is not covered in this procedure. If you wish to add

point code entries to an existing MRN group or MRN set, perform [Provisioning MRN Entries](#) .

If you wish to assign the same weight and threshold value to all the MRN entries in the MRN group or MRN set with the `eswt` and `thr` parameters, or to remove the weight and threshold values from all the MRN entries in the MRN group or MRN set with the `eswt=none` parameter, perform [Changing MRN Entries with the ESWT Parameter](#). The `eswt` and `thr` parameters cannot be used in this procedure.

If you wish to change individual weight values for MRN entries with the `wt/wt1/wt2/wt3/wt4` parameters, the weight values for an RC group with the `grpwt` parameter, the threshold values for an MRN group or MRN set with the `thr` parameter, or the relative cost and weight values for an MRN group or MRN set with the `force=yes` parameter, perform [Changing the Weight and Threshold Values of MRN Entries](#). The `wt/wt1/wt2/wt3/wt4`, `grpwt`, `thr`, and `force=yes` parameters cannot be used in this procedure.

If you wish to change the MAP set, MAP point code, and MAP SSN values assigned to an MRN set, using the `mapset`, `mappc/mappca/mappci/mappcn/mappcn24`, and `mapssn` parameters, perform [Changing the MAPSET, MAP Point Code, and MAP SSN Values of MRN Entries](#). The `mapset`, `mappc/mappca/mappci/mappcn/mappcn24`, and `mapssn` parameters cannot be used in this procedure.

An MRN group or MRN set contains alternate point codes, up to 32, that are used for load sharing between multiple nodes when the EAGLE is performing intermediate global title translation. This load sharing is performed after intermediate global title translation is performed on the message. The point code in the message is changed to the selected point code in the MRN table. If the translated point code is not found in the MRN table, the translated point code in the message is not changed, the message is routed using route for the translated point code.

These parameters are used with the `chg-mrn` command in this procedure.

`:pc/pca/pci/pcn/pcn24` – The point code in the message after intermediate global title translation has been performed.

`:rc` – The relative cost value of point code in the message

`:pc1/pca1/pci1/pcn1/pcn241` – The first alternate point code value

`:rc1` – The relative cost value of the first alternate point code

`:pc2/pca2/pci2/pcn2/pcn242` – The second alternate point code value

`:rc2` – The relative cost value of the second alternate point code

`:pc3/pca3/pci3/pcn3/pcn243` – The third alternate point code value

`:rc3` – The relative cost value of the third alternate point code

`:pc4/pca4/pci4/pcn4/pcn244` – The fourth alternate point code value

`:rc4` – The relative cost value of the fourth alternate point code

 **Note:**

Refer to Chapter 2, Configuring Destination Tables in *Database Administration - SS7 User's Guide* for a definition of the point code types that are used on the EAGLE and for a definition of the different formats that can be used for ITU national point codes.

`:mrnset` – The MRN set ID that the MRN is assigned to, shown in the `rtrv-mrn` output. MRN set IDs are shown only if the Flexible GTT Load Sharing feature is enabled. The `mrnset` parameter value cannot be changed in this procedure. For more information on the Flexible GTT Load Sharing feature, refer to [Flexible GTT Load Sharing](#).

The relative cost parameter values (`rc/rc1/rc2/rc3/rc4`) determine how the global title translation load is to be shared among the alternate point codes. There are three types of load sharing that can be performed: dominant, load shared, or combined dominant/load shared.

All the point codes in a dominant MRN group or MRN set have different relative cost values. The translated point code in the message is the preferred point code that the message is routed on. The relative cost value assigned to the preferred point code does not have to be the lowest value in the MRN group or MRN set. All traffic is routed to the preferred point code, if it is available. If the preferred point code becomes unavailable, the traffic is routed to highest priority alternate point code that is available. When the preferred point code becomes available again, the traffic is then routed back to the preferred point code. For example, the MRN table contains the following entries.

PC	RC
005-005-005	10
006-001-001	20
006-001-002	30
006-001-003	40
006-001-004	50
006-001-005	60
006-001-006	70
006-001-007	80

If the preferred point code is 006-001-001 and it becomes unavailable, the traffic will be routed to point code 006-001-002.

All the point codes in a load shared MRN group have the same relative cost value. Traffic is shared equally between the point codes in this MRN group.

A combined dominant/load shared MRN group or MRN set is a combination of the dominant and load sharing MRN groups or MRN sets. A combined dominant/load shared MRN group or MRN set must contain a minimum of two entries with the same relative cost value and a minimum of one entry with a different relative cost value. Traffic is routed to the point code or point codes with the lowest relative cost value. If more than one point code has the lowest relative cost value, the traffic is shared between these point codes. If the point code or point codes with the lowest relative cost value become unavailable, traffic is routed to the point code or point codes with the next higher relative cost value. If more than one point code has this relative cost

value, the traffic is shared between these point codes. For example, the MRN table contains the following entries.

PC	RC
005-005-005	10
006-001-001	10
006-001-002	10
006-001-003	20
006-001-004	20
006-001-005	20
006-001-006	20
006-001-007	20

If the preferred point code is 006-001-001, the traffic is shared equally between point codes 005-005-005, 006-001-001, and 006-001-002. If point codes 005-005-005, 006-001-001, and 006-001-002 become unavailable, the traffic will be shared equally between point codes, 006-001-003, 006-001-004, 006-001-005, 006-001-006, and 006-001-007.

Canceling the `RTRV-MRN` Command

Because the `rtrv-mrn` command used in this procedure can output information for a long period of time, the `rtrv-mrn` command can be canceled and the output to the terminal stopped. There are three ways that the `rtrv-mrn` command can be canceled.

- Press the `F9` function key on the keyboard at the terminal where the `rtrv-mrn` command was entered.
- Enter the `canc-cmd` without the `trm` parameter at the terminal where the `rtrv-mrn` command was entered.
- Enter the `canc-cmd:trm=<xx>`, where `<xx>` is the terminal where the `rtrv-mrn` command was entered, from another terminal other than the terminal where the `rtrv-mrn` command was entered. To enter the `canc-cmd:trm=<xx>` command, the terminal must allow Security Administration commands to be entered from it and the user must be allowed to enter Security Administration commands. The terminal's permissions can be verified with the `rtrv-secu-trm` command. The user's permissions can be verified with the `rtrv-user` or `rtrv-secu-user` commands.

For more information about the `canc-cmd` command, refer to *Commands User's Guide*.

1. Display the mated relay node groups in the database using the `rtrv-mrn` command. This is an example of the possible output.

```
rlghncxa03w 07-05-07 00:34:31 GMT EAGLE5 37.0.0

      PC          RC
      005-005-005  10
      006-001-001  20
      006-001-002  30
      006-001-003  40
      006-001-004  50
      006-001-005  60
      006-001-006  70
```

```

006-001-007      80

PC              RC
007-007-007      10
008-001-001      20
008-001-002      30
008-001-003      40
008-001-004      50
008-001-005      60
008-001-006      70
    
```

MRN table is (15 of 5990) 1% full

If the Flexible GTT Load Sharing feature is enabled, this is an example of the possible output.

```

MRNSET      PC              RC
DFLT        005-005-005      10
             006-001-001      20
             006-001-002      30
             006-001-003      40
             006-001-004      50
             006-001-005      60
             006-001-006      70
             006-001-007      80

MRNSET      PC              RC
1           007-007-007      10
             008-001-001      20
             008-001-002      30
             008-001-003      40
             008-001-004      50
             008-001-005      60
             008-001-006      70
    
```

MRN table is (15 of 5990) 1% full

If the Weighted GTT Load Sharing feature is enabled and turned on, and the Flexible GTT Load Sharing feature is not enabled, this is an example of the possible output.

rlghncxa03w 07-05-07 00:34:31 GMT EAGLE5 37.0.0

```

PC              RC WT %WT THR
005-005-005      10 10  50  30
006-001-001      10 10  50  30
006-001-002      30 20 100  30
006-001-003      40 20 100  30
006-001-004      50 20 100  30

PC              RC WT %WT THR
007-007-007      10 10  17   1
008-001-001      10 20  33   1
008-001-002      10 30  50   1
    
```

```
008-001-003    20 20 25  1
008-001-004    20 20 25  1
008-001-005    20 20 25  1
008-001-006    20 20 25  1
```

MRN table is (16 of 5990) 1% full

If the Weighted GTT Load Sharing feature is enabled and turned on, and the Flexible GTT Load Sharing feature is enabled, this is an example of the possible output.

rlghncxa03w 07-05-07 00:34:31 GMT EAGLE5 37.0.0

MRNSET	PC	RC	WT	%WT	THR
DFLT	005-005-005	10	10	50	30
	006-001-001	10	10	50	30
	006-001-002	30	20	100	30
	006-001-003	40	20	100	30
	006-001-004	50	20	100	30

MRNSET	PC	RC	WT	%WT	THR
1	007-007-007	10	10	17	1
	008-001-001	10	20	33	1
	008-001-002	10	30	50	1
	008-001-003	20	20	25	1
	008-001-004	20	20	25	1
	008-001-005	20	20	25	1
	008-001-006	20	20	25	1

MRN table is (16 of 5990) 1% full

2. Change the RC values in the MRN group or MRN set by entering the `chg-mrn` command with the point code parameters and their corresponding RC parameters `rc`, `rc1`, `rc2`, `rc3`, and `rc4` parameters.

If only one RC value is being changed, specify the point code value with the `pc/pca/pci/pcn/pcn24` parameter and specify the new RC value with the `rc` parameter. For example, enter this command to change the RC value of the point code 005-005-005 from 10 to 45.

```
chg-mrn:pca=005-005-005:rc=45
```

More than one RC value in the MRN group or MRN set can be changed with the `chg-mrn` command. To change more than one RC value, specify the first point code value with the `pc/pca/pci/pcn/pcn24` parameter and the other point code values with the appropriate alternate point code parameters. The new RC values are specified with the `rc` parameters that correspond to the point code parameters. For example, enter this command to change some of the RC values in the MRN group containing these point codes: 005-005-005, 006-001-001, 006-001-003, 006-001-004, and 006-001-007.

```
chg-
mrn:pca=007-007-007:rc=5:pca=008-001-003:rc=10:pca=008-001-00
4:rc=15 :pca=008-001-001:rc=35:pca=008-001-006:rc=45
```

If the MRNSET column is shown in the `rtrv-mrn` output in step 1, the `mrnset=<MRN Set ID>` parameter, specifying the MRN set containing the point code specified in this step, must be specified with the `chg-mrn` command. To change the RC values in an MRN set, for this example enter these commands.

```
chg-mrn:pca=005-005-005:rc=45:mrnset=df1t

chg-
mrn:pca=007-007-007:rc=5:pca=008-001-003:rc=10:pca=008-001-004:rc=15 :pca=008-001-001:rc=35:pca=008-001-006:rc=45:mrnset=1
```

 **Note:**

If the RC values are changed so that the resulting MRN group of MRN set becomes a dominant MRN group or MRN set (the RC values are unique), and the MRN group of MRN set had weight and in-service thresholds assigned, the weight and in-service threshold values will be removed from the MRN group of MRN set.

When the `chg-mrn` command has successfully completed, this message should appear.

```
rlghncxa03w 07-05-07 11:44:13 GMT EAGLE5 37.0.0
CHG-MRN: MASP A - COMPLTD
```

Repeat this step to change other entries in the MRN group or MRN set.

3. Verify the changes using the `rtrv-mrn` command with the point code (`pca/pci/pcn/pcn24` parameters) specified in step 2. If the `mrnset` parameter was specified in step 2, the `mrnset` parameter and value specified in step 2 must be specified with the `rtrv-mrn` command in this step.

For this example, enter these commands.

```
rtrv-mrn:pca=005-005-005
```

This is an example of the possible output.

```
rlghncxa03w 07-05-07 00:34:31 GMT EAGLE5 37.0.0
```

PC	RC
006-001-001	20
006-001-002	30
006-001-003	40
005-005-005	45
006-001-004	50
006-001-005	60
006-001-006	70
006-001-007	80

```
MRN table is (15 of 2990) 1% full
```

```
rtrv-mrn:pca=007-007-007
```

This is an example of the possible output.

```
rlghncxa03w 07-05-07 00:34:31 GMT EAGLE5 37.0.0
```

PC	RC
007-007-007	5
008-001-003	10
008-001-004	15
008-001-002	30
008-001-001	35
008-001-006	45
008-001-005	60

MRN table is (15 of 5990) 1% full

If the Flexible GTT Load Sharing feature is enabled for this example, enter these commands.

```
rtrv-mrn:pca=005-005-005:mrnset=dflt
```

This is an example of the possible output.

```
rlghncxa03w 07-05-07 00:34:31 GMT EAGLE5 37.0.0
```

MRNSET	PC	RC
DFLT	006-001-001	20
	006-001-002	30
	006-001-003	40
	005-005-005	45
	006-001-004	50
	006-001-005	60
	006-001-006	70
	006-001-007	80

MRN table is (15 of 5990) 1% full

```
rtrv-mrn:pca=007-007-007:mrnset=1
```

This is an example of the possible output.

```
rlghncxa03w 07-05-07 00:34:31 GMT EAGLE5 37.0.0
```

MRNSET	PC	RC
1	007-007-007	5
	008-001-003	10
	008-001-004	15
	008-001-002	30
	008-001-001	35
	008-001-006	45
	008-001-005	60

MRN table is (15 of 5990) 1% full

If the Weighted GTT Load Sharing feature is enabled and turned on, and the Flexible GTT Load Sharing feature is not enabled for this example, enter these commands.

This is an example of the possible output.

```
rtrv-mrn:pca=005-005-005
```

```
rlghncxa03w 07-05-07 00:34:31 GMT EAGLE5 37.0.0
```

PC	RC	WT	%WT	THR
006-001-001	10	--	--	--
006-001-002	30	--	--	--
006-001-003	40	--	--	--
005-005-005	45	--	--	--
006-001-004	50	--	--	--

```
rtrv-mrn:pca=007-007-007
```

PC	RC	WT	%WT	THR
007-007-007	5	10	100	1
008-001-002	10	30	60	1
008-001-003	10	20	40	1
008-001-004	15	20	100	1
008-001-005	20	20	100	1
008-001-001	35	20	100	1
008-001-006	45	20	100	1

If the Weighted GTT Load Sharing feature is enabled and turned on, and the Flexible GTT Load Sharing feature is enabled for this example, enter these commands.

This is an example of the possible output.

```
rtrv-mrn:pca=005-005-005:mrnset=dflt
```

```
rlghncxa03w 07-05-07 00:34:31 GMT EAGLE5 37.0.0
```

MRNSET	PC	RC	WT	%WT	THR
DFLT	006-001-001	10	--	--	--
	006-001-002	30	--	--	--
	006-001-003	40	--	--	--
	005-005-005	45	--	--	--
	006-001-004	50	--	--	--

```
rtrv-mrn:pca=007-007-007:mrnset=1
```

MRNSET	PC	RC	WT	%WT	THR
1	007-007-007	5	10	100	1
	008-001-002	10	30	60	1
	008-001-003	10	20	40	1
	008-001-004	15	20	100	1
	008-001-005	20	20	100	1

```
008-001-001    35 20 100    1
008-001-006    45 20 100    1
```

- Backup the new changes using the `chg-db:action=backup:dest=fixed` command. These messages should appear, the active Maintenance and Administration Subsystem Processor (MASP) appears first.

```
BACKUP (FIXED) : MASP A - Backup starts on active MASP.
BACKUP (FIXED) : MASP A - Backup on active MASP to fixed disk
complete.
BACKUP (FIXED) : MASP A - Backup starts on standby MASP.
BACKUP (FIXED) : MASP A - Backup on standby MASP to fixed disk
complete.
```

Figure 2-141 Change the Relative Cost Values of MRN Entries

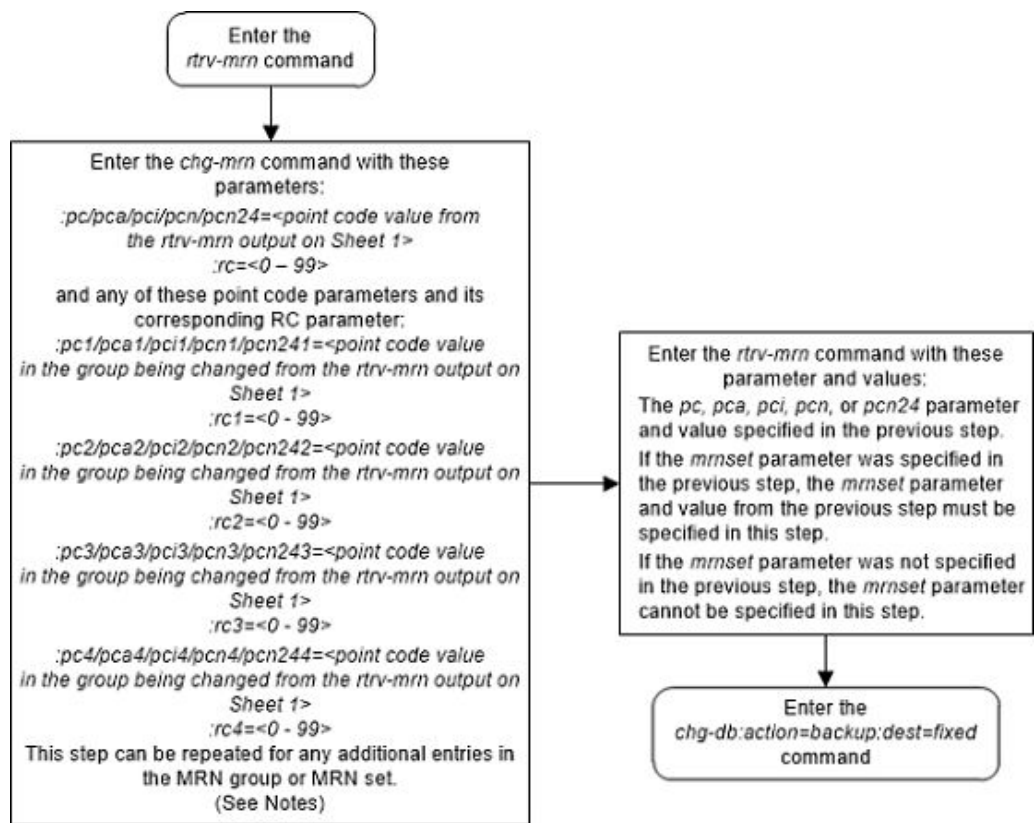

Notes:

- If the `MRNSET` field is shown in the `rtrv-mrn` output on Sheet 1, the `mmset=<current MRN set ID>` parameter, specifying the MRN set containing the point code specified in this step, must be specified with the `chg-mrn` or `rtrv-mrn` command.
- If the `MRNSET` field is not shown in the `rtrv-mrn` output on Sheet 1, the `mmset` parameter cannot be specified with the `chg-mrn` or `rtrv-mrn` command.
- A dominant MRN group or MRN set contains entries whose RC values are unique.
- A load shared MRN group or MRN set contains entries whose RC values are equal.
- A combined dominant/load shared MRN group or MRN set contains a minimum of two entries shows RC values are equal, and a minimum of one entry whose RC value is different.
- If weights and in-service thresholds are assigned to the MRN group or MRN set being changed, and the MRN group or MRN set is being changed to a dominant MRN group or MRN set, the weight and in-service threshold values will be removed from the MRN group or MRN set.

Changing MRN Entries with the ESWT Parameter

This procedure is used to change the weight values of all the entries in an existing Mated Relay Node (MRN) group or MRN set using the `eswt` parameter of the `chg-mrn` command.

The `chg-mrn` command can also be used to add point code entries to an existing MRN group or MRN set. This action is not covered in this procedure. If you wish to add point code entries to an existing MRN group or MRN set, perform [Provisioning MRN Entries](#).

If the MRN entries being changed do not have weight and threshold values assigned to them, perform [Changing the Relative Cost Values of MRN Entries](#).

If you wish to change individual weight values for MRN entries with the `wt/wt1/wt2/wt3/wt4` parameters, the weight values for an RC group with the `grpwt` parameter, the threshold values for an MRN group or MRN set with the `thr` parameter, or the relative cost and weight values for an MRN group or MRN set with the `force=yes` parameter, perform [Changing the Weight and Threshold Values of MRN Entries](#). The `wt/wt1/wt2/wt3/wt4`, `grpwt`, `thr`, and `force=yes` parameters cannot be used in this procedure.

If you wish to change the MAP set, MAP point code, and MAP SSN values assigned to an MRN set, using the `mapset`, `mappc/mappca/mappci/mappcn/mappcn24`, and `mapssn` parameters, perform [Changing the MAPSET, MAP Point Code, and MAP SSN Values of MRN Entries](#). The `mapset`, `mappc/mappca/mappci/mappcn/mappcn24`, and `mapssn` parameters cannot be used in this procedure.

An MRN group or MRN set contains alternate point codes, up to 32, that are used for load sharing between multiple nodes when the EAGLE is performing intermediate global title translation. This load sharing is performed after intermediate global title translation is performed on the message. The point code in the message is changed to the selected point code in the MRN table. If the translated point code is not found in the MRN table, the translated point code in the message is not changed, the message is routed using route for the translated point code.

These parameters are used with the `chg-mrn` command in this procedure.

`:pc/pca/pci/pcn/pcn24` – The point code in the message after intermediate global title translation has been performed.

`:rc` – The relative cost value of point code in the message

`:pc1/pca1/pci1/pcn1/pcn241` – The first alternate point code value

`:rc1` – The relative cost value of the first alternate point code

`:pc2/pca2/pci2/pcn2/pcn242` – The second alternate point code value

`:rc2` – The relative cost value of the second alternate point code

`:pc3/pca3/pci3/pcn3/pcn243` – The third alternate point code value

`:rc3` – The relative cost value of the third alternate point code

`:pc4/pca4/pci4/pcn4/pcn244` – The fourth alternate point code value

`:rc4` – The relative cost value of the fourth alternate point code

 **Note:**

Refer to Chapter 2, Configuring Destination Tables in *Database Administration - SS7 User's Guide* for a definition of the point code types that are used on the EAGLE and for a definition of the different formats that can be used for ITU national point codes.

`:mrnset` – The MRN set ID that the MRN is assigned to, shown in the `rtv-mrn` output. MRN set IDs are shown only if the Flexible GTT Load Sharing feature is enabled. The `mrnset` parameter value cannot be changed in this procedure. For more information on the Flexible GTT Load Sharing feature, refer to [Flexible GTT Load Sharing](#).

`:eswt` – The entity set weight value. When this parameter is specified, the same weight value is assigned to all entries in the MRN group or MRN set that contain the point code value specified in the `chg-mrn` command. A MRN group or MRN set can also be referred to as an entity set. The value of this parameter is from 1 - 99.

`:thr` – The in-service threshold assigned to the MRN group or MRN set. The in-service threshold is the minimum percentage (from 1 - 100) of weight that must be available for an RC group (a group of entries in the MRN group or MRN set that have the same RC value assigned) to be considered available to carry traffic. If the percentage of the available weight is less than the in-service threshold, then the entire RC group is considered unavailable for traffic. If the percentage of the available weight is equal to or greater than the in-service threshold, then the RC group is considered available, and traffic can be sent to any available entity in the RC group. When the `thr` parameter is specified with the `eswt` parameter in this procedure, the in-service threshold value is assigned to all the entries of the MRN group or MRN set.

The relative cost parameter values (`rc/rc1/rc2/rc3/rc4`) determine how the global title translation load is to be shared among the alternate point codes. There are three types of load sharing that can be performed: dominant, load shared, or combined dominant/load shared.

All the point codes in a dominant MRN group or MRN set have different relative cost values. The translated point code in the message is the preferred point code that the message is routed on. The relative cost value assigned to the preferred point code does not have to be the lowest value in the MRN group or MRN set. All traffic is routed to the preferred point code, if it is available. If the preferred point code becomes unavailable, the traffic is routed to highest priority alternate point code that is available. When the preferred point code becomes available again, the traffic is then routed back to the preferred point code. For example, the MRN table contains the following entries.

PC	RC
005-005-005	10
006-001-001	20
006-001-002	30
006-001-003	40
006-001-004	50
006-001-005	60
006-001-006	70
006-001-007	80

If the preferred point code is 006-001-001 and it becomes unavailable, the traffic will be routed to point code 006-001-002.

All the point codes in a load shared MRN group have the same relative cost value. Traffic is shared equally between the point codes in this MRN group.

A combined dominant/load shared MRN group or MRN set is a combination of the dominant and load sharing MRN groups or MRN sets. A combined dominant/load shared MRN group or MRN set must contain a minimum of two entries with the same relative cost value and a minimum of one entry with a different relative cost value. Traffic is routed to the point code or point codes with the lowest relative cost value. If more than one point code has the lowest relative cost value, the traffic is shared between these point codes. If the point code or point codes with the lowest relative cost value become unavailable, traffic is routed to the the point code or point codes with the next higher relative cost value. If more than one point code has this relative cost value, the traffic is shared between these point codes. For example, the MRN table contains the following entries.

PC	RC
005-005-005	10
006-001-001	10
006-001-002	10
006-001-003	20
006-001-004	20
006-001-005	20
006-001-006	20
006-001-007	20

If the preferred point code is 006-001-001, the traffic is shared equally between point codes 005-005-005, 006-001-001, and 006-001-002. If point codes 005-005-005, 006-001-001, and 006-001-002 become unavailable, the traffic will be shared equally between point codes, 006-001-003, 006-001-004, 006-001-005, 006-001-006, and 006-001-007.

The `eswt` and `thr` parameters can be used only:

- If the MRN group or MRN set is either a load shared or combined dominant/load shared MRN group or MRN set.
- If the Weighted GTT Load Sharing feature is enabled and turned on.

The status of the Weighted GTT Load Sharing feature can be verified by entering the `rtrv-ctrl-feat` command. If the Weighted GTT Load Sharing feature is not enabled or not turned on, perform [Activating the Weighted GTT Load Sharing Feature](#) to enable and turn on the Weighted GTT Load Sharing feature.

The `eswt` parameter assigns same weight value to all the entries in the MRN group or MRN set that contains the point code value specified in the `chg-mrn` command.

The `eswt` and `thr` parameters can be specified with the `chg-mrn` command only with the `pc/pca/pci/pcn/pcn24` parameter and without the alternate point code, relative cost (`rc`, `rc1`, `rc2`, `rc3`, `rc4`), group weight (`grpwt`), and individual weight (`wt`, `wt1`, `wt2`, `wt3`, `wt4`) parameters.

The weight values assigned to the entires in the MRN group or MRN set are shown in the `WT` column in the `rtrv-mrn` output.

The in-service threshold values assigned to the entities in the MRN group or MRN set are shown in the `THR` column in the `rtrv-mrn` output.

The `%WT` column in the `rtrv-mrn` output shows the percentage of the traffic the particular entry in the entity set will handle.

The `WT`, `%WT`, and `THR` columns are shown in the `rtrv-mrn` output only if the Weighted GTT Load Sharing feature is enabled and turned on.

For more information on the Weighted GTT Load Sharing feature, refer to [Weighted GTT Load Sharing](#).

Canceling the `RTRV-MRN` Command

Because the `rtrv-mrn` command used in this procedure can output information for a long period of time, the `rtrv-mrn` command can be canceled and the output to the terminal stopped. There are three ways that the `rtrv-mrn` command can be canceled.

- Press the `F9` function key on the keyboard at the terminal where the `rtrv-mrn` command was entered.
- Enter the `canc-cmd` without the `trm` parameter at the terminal where the `rtrv-mrn` command was entered.
- Enter the `canc-cmd:trm=<xx>`, where `<xx>` is the terminal where the `rtrv-mrn` command was entered, from another terminal other than the terminal where the `rtrv-mrn` command was entered. To enter the `canc-cmd:trm=<xx>` command, the terminal must allow Security Administration commands to be entered from it and the user must be allowed to enter Security Administration commands. The terminal's permissions can be verified with the `rtrv-secu-trm` command. The user's permissions can be verified with the `rtrv-user` or `rtrv-secu-user` commands.

For more information about the `canc-cmd` command, refer to *Commands User's Guide*.

1. Display the mated relay node groups in the database using the `rtrv-mrn` command. This is an example of the possible output.

```
rlghncxa03w 06-10-07 00:34:31 GMT EAGLE5 36.0.0
```

PC	RC
005-005-005	10
006-001-001	20
006-001-002	30
006-001-003	40
006-001-004	50
006-001-005	60
006-001-006	70
006-001-007	80

PC	RC
007-007-007	10
008-001-001	20
008-001-002	30
008-001-003	40
008-001-004	50

```
008-001-005    60
008-001-006    70
```

MRN table is (15 of 5990) 1% full

If the Flexible GTT Load Sharing feature is enabled, this is an example of the possible output.

```
MRNSET    PC                RC
DFLT      007-007-007    10
           008-001-001    20
           008-001-002    30
           008-001-003    40
           008-001-004    50
           008-001-005    60
           008-001-006    70
```

```
MRNSET    PC                RC
1          005-005-005    10
           006-001-001    20
           006-001-002    30
           006-001-003    40
           006-001-004    50
           006-001-005    60
           006-001-006    70
           006-001-007    80
```

MRN table is (15 of 5990) 1% full

If the Weighted GTT Load Sharing feature is enabled and turned on, and the Flexible GTT Load Sharing feature is not enabled, this is an example of the possible output.

```
rlghncxa03w 06-10-07 00:34:31 GMT EAGLE5 36.0.0
```

```
PC                RC WT %WT THR
008-005-005      10 10  50  30
008-001-001      10 10  50  30
008-001-002      30 20 100  30
008-001-003      40 20 100  30
008-001-004      50 20 100  30
```

```
PC                RC WT %WT THR
009-005-005      10 10   4   1
009-001-001      10 10   4   1
009-001-002      10 30  12   1
009-001-003      10 40  15   1
009-001-005      10 40  15   1
009-001-006      10 40  15   1
009-001-007      10 40  15   1
009-001-004      10 50  19   1
009-001-008      20 20  25   1
009-001-009      20 30  37   1
009-001-010      20 30  37   1
```

MRN table is (16 of 5990) 1% full

If the Weighted GTT Load Sharing feature is enabled and turned on, and the Flexible GTT Load Sharing feature is enabled, this is an example of the possible output.

rlghncxa03w 06-10-07 00:34:31 GMT EAGLE5 36.0.0

MRNSET	PC	RC	WT	%WT	THR
DFLT	005-005-005	10	10	50	30
	006-001-001	10	10	50	30
	006-001-002	30	20	100	30
	006-001-003	40	20	100	30
	006-001-004	50	20	100	30

MRNSET	PC	RC	WT	%WT	THR
1	005-005-005	10	10	4	1
	006-001-001	10	10	4	1
	006-001-002	10	30	12	1
	006-001-003	10	40	15	1
	006-001-005	10	40	15	1
	006-001-006	10	40	15	1
	006-001-007	10	40	15	1
	006-001-004	10	50	19	1
	006-001-008	20	20	25	1
	006-001-009	20	30	37	1
	006-001-010	20	30	37	1

MRN table is (16 of 5990) 1% full

2. If you wish to assign weight and in-service threshold values to the MRN entries in the MRN group or MRN set, and the WT, %WT, and THR columns are shown in the `rtrv-mrn` output in step 1, then the Weighted GTT Load Sharing feature is enabled and turned on. Go to step 3.

 **Note:**

If weight and threshold values are assigned to the MRN group or MRN set, skip this step and go to step 3.

 **Note:**

If weight and threshold values are assigned to the MRN group or MRN set, and the weight and threshold values are being removed from the MRN group or MRN set, skip steps 2 and 3 and go to step 4.

If the WT, %WT, and THR columns are not shown in the `rtrv-mrn` output in step 1, perform [Activating the Weighted GTT Load Sharing Feature](#) to enable and turn

on the Weighted GTT Load Sharing feature. After the Weighted GTT Load Sharing feature is enabled and turned on, go to step 3.

3. To assign weight and in-service threshold values to a dominant MRN group or MRN set, the dominant MRN group or MRN set must be changed to either a load shared or combined dominant/load shared MRN group or MRN set.

 **Note:**

If existing MRN group or MRN set that the weight and in-service threshold values are being assigned to is a load shared or combined dominant/load shared MRN group or MRN set, skip step 3 and go to step 4.

If you wish to change the dominant MRN group or MRN set to a load shared or combined dominant/load shared MRN group or MRN set by adding additional entries to the MRN group or MRN set, perform [Provisioning MRN Entries](#).

To change the dominant MRN group or MRN set to a load shared or combined dominant/load shared MRN group or MRN set without adding any additional entries to the MRN group or MRN set, enter the `chg-mrn` command specifying the point codes in the MRN group or MRN set with the point codes corresponding RC parameters with the new RC values.

To create a load shared MRN group or MRN set, the new RC values for all the entries in the MRN group or MRN set must be equal.

To create a combined dominant/load shared MRN group or MRN set, a minimum of two the new RC values must be equal and a minimum of one other RC value must be different.

If the MRNSET column is not shown in the `rtrv-mrn` output in step 1, the `mrnset` parameter cannot be specified with the `chg-mrn` command.

For this example, enter this command.

```
chg-
mrn:pca=007-007-007:rc=10:pca1=008-001-001:rc1=10 :pca2=008-0
01-002:rc2=10:pca3=008-001-003:rc3=10 :pca4=008-001-004:rc4=1
0
```

If the MRNSET column is shown in the `rtrv-mrn` output in step 1, the `mrnset=<MRN Set ID>` parameter, specifying the MRN set containing the point code specified in this step, must be specified with the `chg-mrn` command. To change the RC values in an MRN set, for this example enter this command.

```
chg-
mrn:pca=007-007-007:rc=10:pca1=008-001-001:rc1=10 :pca2=008-0
01-002:rc2=10:pca3=008-001-003:rc3=10 :pca4=008-001-004:rc4=1
0:mrnset=df1t
```

This step must be repeated until the RC values for all the entries in the MRN group or MRN set have been changed.

After this step is performed, skip steps 4, 5, and 6, and go to step 7.

4. Change the weight and in-service threshold values of the load shared or combined dominant/load shared MRN group or MRN set.

Enter the `chg-mrn` command with the `eswt` and `thr` parameters to make these changes:

- Assign weight and threshold values to a non-weighted MRN group or MRN set.
- Change the existing weight values of a weighted MRN group or MRN set to the same weight value. The threshold can also be changed.

The `eswt` parameter assigns the same weight value to all the entries in the MRN group or MRN set. The `thr` parameter assigns the same threshold value to all the entries in the MRN group or MRN set.

If you wish to remove all the weight and threshold values from the MRN group or MRN set, enter the `chg-mrn` command with the `eswt=none` parameter. The `thr` parameter cannot be specified with the `eswt=none` parameter.

For this example, enter one of these commands.

To assign only weight values to all entries in the MRN group without the Flexible GTT Load Sharing feature enabled, enter this command.

```
chg-mrn:pca=007-007-007:eswt=30
```

To change the weight and in-service threshold values of all the entries in the MRN group without the Flexible GTT Load Sharing feature enabled, enter this command.

```
chg-mrn:pca=007-007-007:eswt=20:thr=30
```

To change only weight values of all the entries in the MRN set with the Flexible GTT Load Sharing feature enabled, enter this command.

```
chg-mrn:pca=007-007-007:eswt=30:mrnset=df1t
```

To change the weight and in-service threshold values of all the entries in the MRN set with the Flexible GTT Load Sharing feature enabled, enter this command.

```
chg-mrn:pca=007-007-007:eswt=20:thr=30:mrnset=df1t
```

To remove the weight and in-service threshold values from all the entries in the MRN set without the Flexible GTT Load Sharing feature enabled, enter this command.

```
chg-mrn:pca=007-007-007:eswt=none
```

To remove the weight and in-service threshold values from all the entries in the MRN set with the Flexible GTT Load Sharing feature enabled, enter this command.

```
chg-mrn:pca=007-007-007:eswt=none:mrnset=df1t
```

If the MRN group or MRN set did not have weight and in-service threshold values assigned before this step was performed, and the `thr` parameter is not specified in this step, the in-service threshold value 1 (1%) is assigned to the entries.

When the `chg-mrn` command has successfully completed, this message should appear.

```
rlghncxa03w 06-10-07 11:44:13 GMT EAGLE5 36.0.0  
CHG-MRN: MASP A - COMPLTD
```

5. Verify the changes using the `rtrv-mrn` command with the point code (`pca/pci/pcn/pcn24` parameters) specified in step 4. If the `mrnset` parameter

was specified in step 4, the `mrnset` parameter and value specified in step 4 must be specified with the `rtrv-mrn` command in this step.

For this example, enter these commands.

```
rtrv-mrn:pca=007-007-007
```

If only the weight values were changed in step 4, this is an example of the possible output.

```
rlghncxa03w 06-10-07 00:34:31 GMT EAGLE5 36.0.0
```

PC	RC	WT	%WT	THR
007-007-007	10	30	14	1
008-001-001	10	30	14	1
008-001-002	10	30	14	1
008-001-003	10	30	14	1
008-001-004	10	30	14	1
008-001-005	10	30	14	1
008-001-006	10	30	14	1

MRN table is (15 of 5990) 1% full

If the weight and in-service threshold values were changed in step 4, this is an example of the possible output.

```
rlghncxa03w 06-10-07 00:34:31 GMT EAGLE5 36.0.0
```

PC	RC	WT	%WT	THR
007-007-007	10	20	14	30
008-001-001	10	20	14	30
008-001-002	10	20	14	30
008-001-003	10	20	14	30
008-001-004	10	20	14	30
008-001-005	10	20	14	30
008-001-006	10	20	14	30

MRN table is (15 of 5990) 1% full

```
rtrv-mrn:pca=007-007-007:mrnset=dflt
```

If an MRN set was changed in step 4, this is an example of the possible output.

```
rlghncxa03w 06-10-07 00:34:31 GMT EAGLE5 36.0.0
```

MRNSET	PC	RC	WT	%WT	THR
DFLT	007-007-007	10	30	14	1
	008-001-001	10	30	14	1
	008-001-002	10	30	14	1
	008-001-003	10	30	14	1
	008-001-004	10	30	14	1
	008-001-005	10	30	14	1
	008-001-006	10	30	14	1

MRN table is (15 of 5990) 1% full

If the weight and in-service threshold values were changed in an MRN set in step 4, this is an example of the possible output.

```
rlghncxa03w 06-10-07 00:34:31 GMT EAGLE5 36.0.0
```

MRNSET	PC	RC	WT	%WT	THR
DFLT	007-007-007	10	20	14	30
	008-001-001	10	20	14	30
	008-001-002	10	20	14	30
	008-001-003	10	20	14	30
	008-001-004	10	20	14	30
	008-001-005	10	20	14	30
	008-001-006	10	20	14	30

```
MRN table is (15 of 5990) 1% full
```

If the weight and in-service threshold values were removed in step 4, and the Flexible GTT Load Sharing feature is not enabled, this is an example of the possible output.

```
rlghncxa03w 06-10-07 00:34:31 GMT EAGLE5 36.0.0
```

PC	RC	WT	%WT	THR
007-007-007	10	--	--	--
008-001-001	10	--	--	--
008-001-002	10	--	--	--
008-001-003	10	--	--	--
008-001-004	10	--	--	--
008-001-005	10	--	--	--
008-001-006	10	--	--	--

```
MRN table is (15 of 5990) 1% full
```

```
rtrv-mrn:pca=007-007-007:mrnset=dflt
```

If the weight and in-service threshold values were removed from an MRN set was changed in step 4, this is an example of the possible output.

```
rlghncxa03w 06-10-07 00:34:31 GMT EAGLE5 36.0.0
```

MRNSET	PC	RC	WT	%WT	THR
DFLT	007-007-007	10	--	--	--
	008-001-001	10	--	--	--
	008-001-002	10	--	--	--
	008-001-003	10	--	--	--
	008-001-004	10	--	--	--
	008-001-005	10	--	--	--
	008-001-006	10	--	--	--

```
MRN table is (15 of 5990) 1% full
```

6. Backup the new changes using the `chg-db:action=backup:dest=fixed` command. These messages should appear, the active Maintenance and Administration Subsystem Processor (MASP) appears first.

```
BACKUP (FIXED) : MASP A - Backup starts on active MASP.  
BACKUP (FIXED) : MASP A - Backup on active MASP to fixed disk  
complete.  
BACKUP (FIXED) : MASP A - Backup starts on standby MASP.  
BACKUP (FIXED) : MASP A - Backup on standby MASP to fixed disk  
complete.
```

Figure 2-142 Change MRN Entries with the ESWT Parameter - Sheet 1 of 4

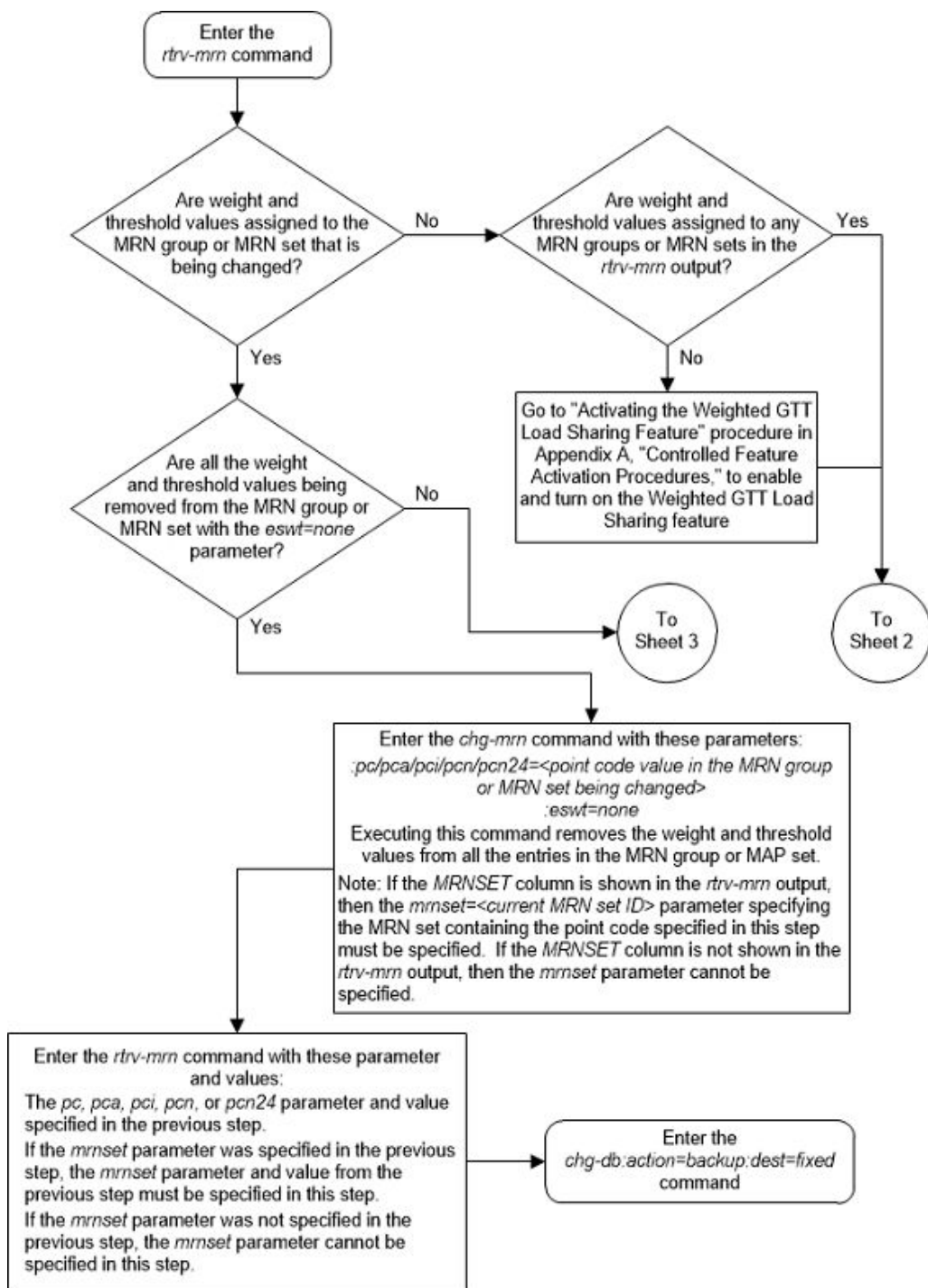

Figure 2-143 Change MRN Entries with the ESWT Parameter - Sheet 2 of 4

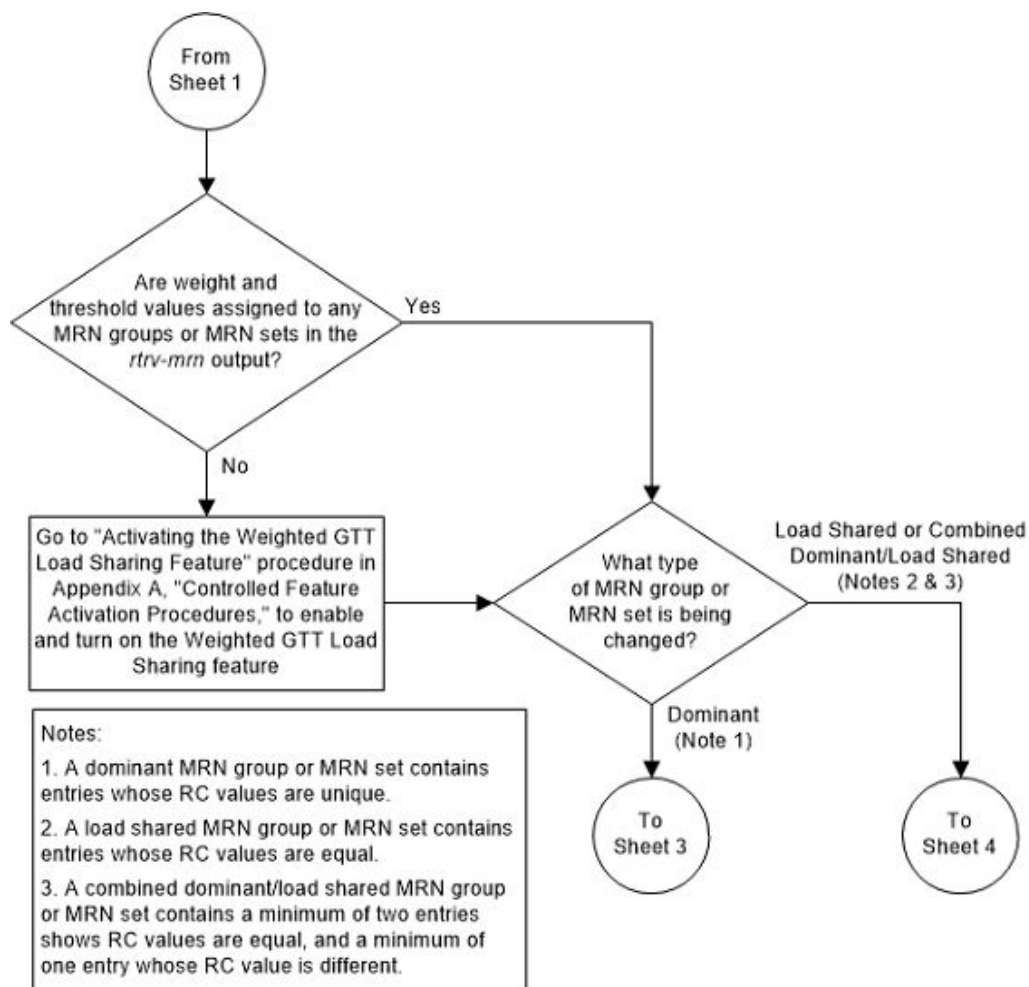

Figure 2-144 Change MRN Entries with the ESWT Parameter - Sheet 3 of 4

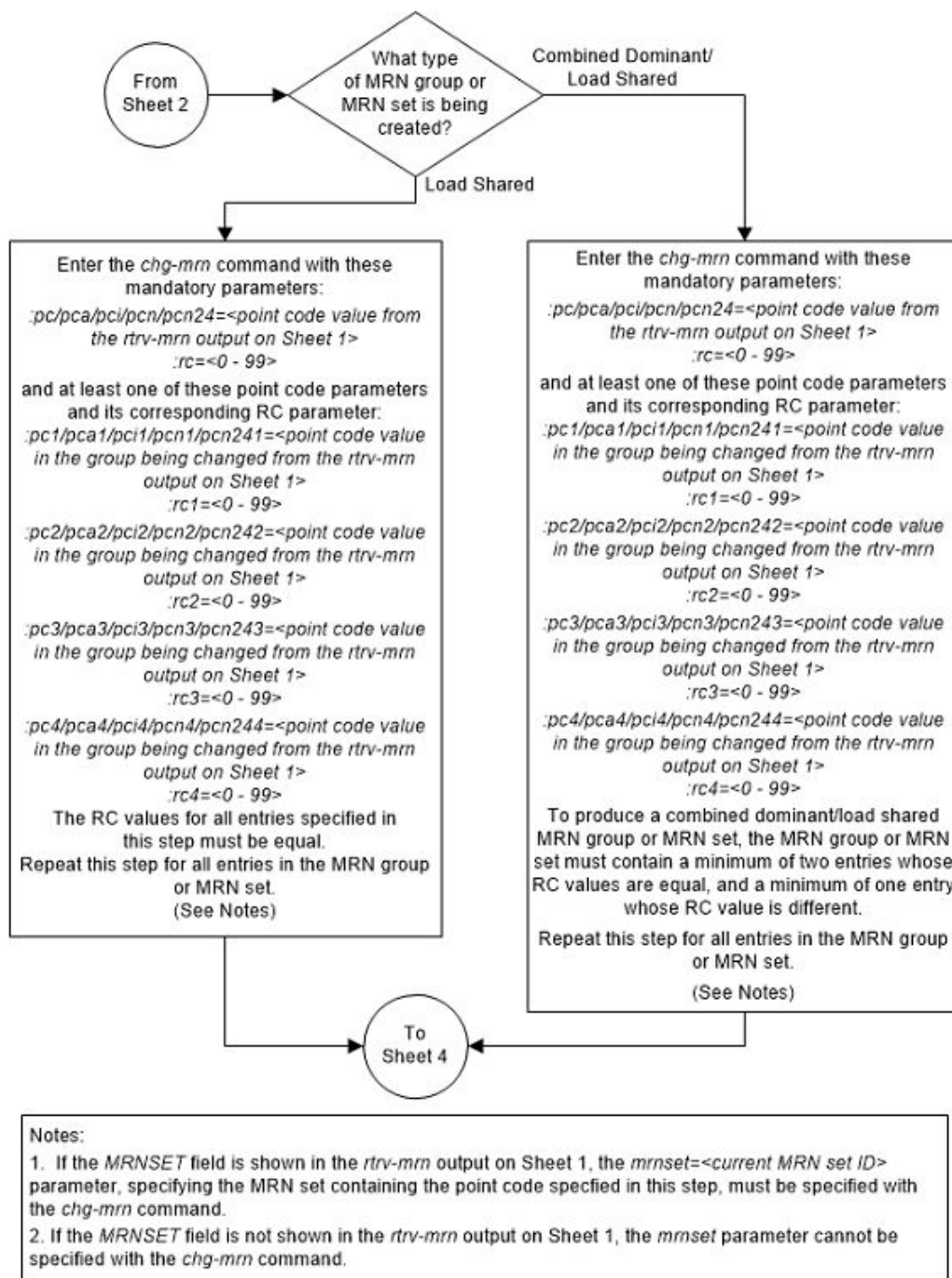
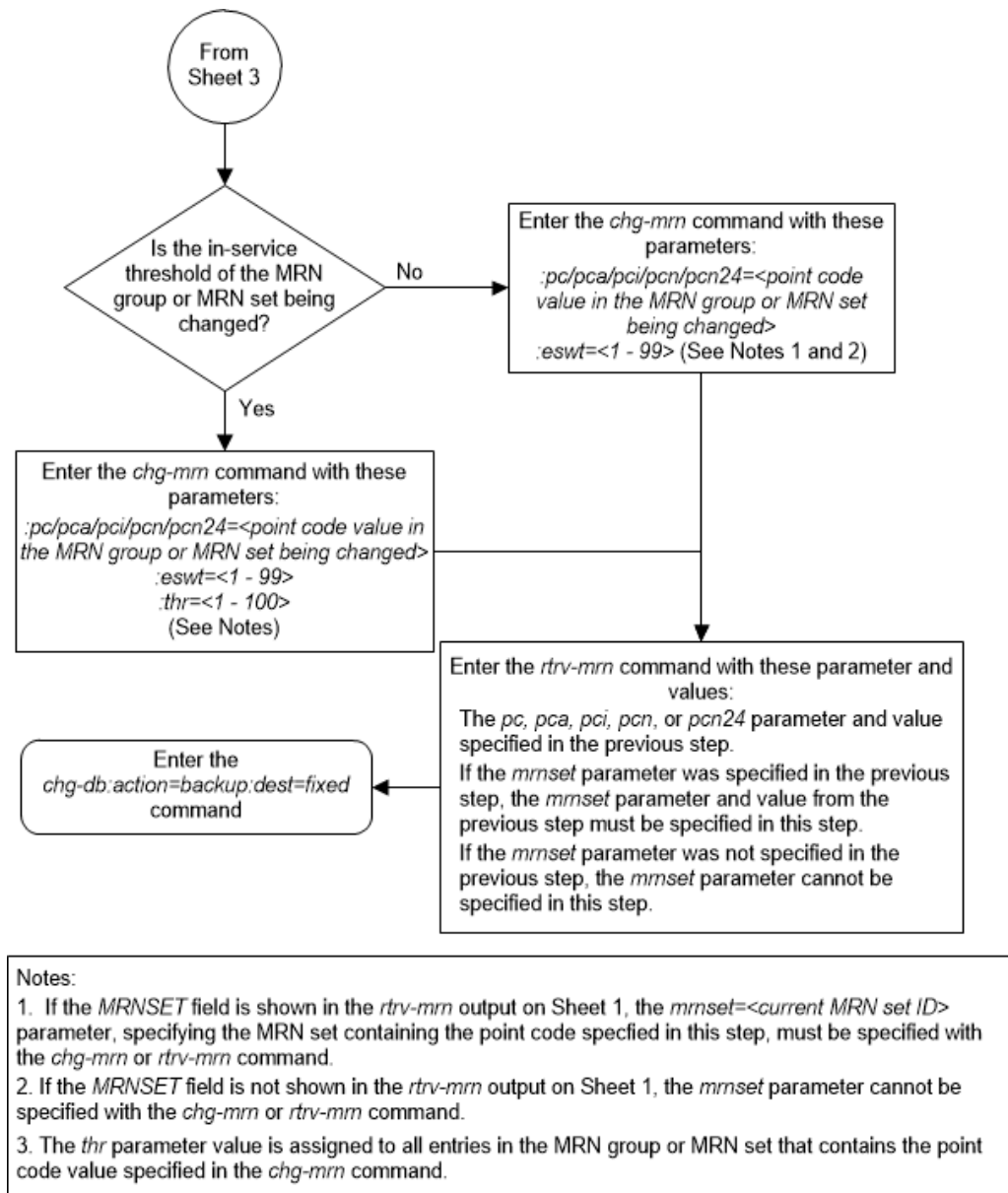

Figure 2-145 Change MRN Entries with the ESWT Parameter - Sheet 4 of 4



Changing the Weight and Threshold Values of MRN Entries

This procedure is used to change the weight and threshold values of entries in an existing Mated Relay Node (MRN) group or MRN set to new weight and threshold values. The weight and threshold values are changed using the `chg-mrn` command. This procedure can be performed only on MRN entries that have weight and thresholds assigned.

The following changes can be made in this procedure:

- The individual weight values of the entries in the MRN group or MRN set with the `wt/wt1/wt2/wt3/wt4` parameters.

- The individual weight and relative cost values of the entries in the MRN group or MRN set with the `wt/wt1/wt2/wt3/wt4`, `rc/rc1/rc2/rc3/rc4`, and `force=yes` parameters.
- The threshold values of the entities in the MRN group or MRN set that have the same relative cost value with the `thr` parameter. The new threshold value is assigned to the entities in the MRN group or MRN set that have the same relative cost value.
- The weight values of the entities in the MRN group or MRN set that have the same relative cost value with the `grpwt` parameter. The new weight value is assigned to the entities in the MRN group or MRN set that have the same relative cost value.
- The threshold and weight values of the entities in the MRN group or MRN set that have the same relative cost value with the `thr` and `grpwt` parameters. The new threshold and weight value is assigned to the entities in the MRN group or MRN set that have the same relative cost value.

The `chg-mrn` command can also be used to add point code entries to an existing MRN group or MRN set. This action is not covered in this procedure. If you wish to add point code entries to an existing MRN group or MRN set, perform [Provisioning MRN Entries](#).

If the MRN entries being changed do not have weight and threshold values assigned to them, perform [Changing the Relative Cost Values of MRN Entries](#).

If you wish to assign the same weight and threshold value to all the MRN entries in the MRN group or MRN set with the `eswt` and `thr` parameters, or to remove the weight and threshold values from all the MRN entries in the MRN group or MRN set with the `eswt=none` parameter, perform [Changing MRN Entries with the ESWT Parameter](#). The `eswt` parameter cannot be used in this procedure.

If you wish to change the MAP set, MAP point code, and MAP SSN values assigned to an MRN set, using the `mapset`, `mappc/mappca/mappci/mappcn/mappcn24`, and `mapssn` parameters, perform [Changing the MAPSET, MAP Point Code, and MAP SSN Values of MRN Entries](#). The `mapset`, `mappc/mappca/mappci/mappcn/mappcn24`, and `mapssn` parameters cannot be used in this procedure.

An MRN group or MRN set contains alternate point codes, up to 32, that are used for load sharing between multiple nodes when the EAGLE is performing intermediate global title translation. This load sharing is performed after intermediate global title translation is performed on the message. The point code in the message is changed to the selected point code in the MRN table. If the translated point code is not found in the MRN table, the translated point code in the message is not changed, the message is routed using route for the translated point code.

The `chg-mrn` command uses these parameters.

`:pc/pca/pci/pcn/pcn24` – The point code in the message after intermediate global title translation has been performed.

`:rc` – The relative cost value of point code in the message

`:pc1/pca1/pci1/pcn1/pcn241` – The first alternate point code value

`:rc1` – The relative cost value of the first alternate point code

`:pc2/pca2/pci2/pcn2/pcn242` – The second alternate point code value

`:rc2` – The relative cost value of the second alternate point code

- :pc3/pca3/pci3/pcn3/pcn243 – The third alternate point code value
- :rc3 – The relative cost value of the third alternate point code
- :pc4/pca4/pci4/pcn4/pcn244 – The fourth alternate point code value
- :rc4 – The relative cost value of the fourth alternate point code

**Note:**

Refer to Chapter 2, Configuring Destination Tables in *Database Administration - SS7 User's Guide* for a definition of the point code types that are used on the EAGLE and for a definition of the different formats that can be used for ITU national point codes.

:mrnset – The MRN set ID that the MRN is assigned to, shown in the `rtrv-mrn` output. MRN set IDs are shown only if the Flexible GTT Load Sharing feature is enabled. The `mrnset` parameter value cannot be changed in this procedure. For more information on the Flexible GTT Load Sharing feature, refer to [Flexible GTT Load Sharing](#).

:grpwt – The group weight value. When this parameter is specified, the same weight value is assigned to all entries that have the same RC (relative cost) value in the MRN group or MRN set that contain the point code specified in the `chg-mrn` command. The value of this parameter is from 1 - 99.

:wt – The weight value assigned to the `pc/pca/pci/pcn/pcn24` parameter value. The value of this parameter is from 1 - 99.

:wt1 – The weight value assigned to the `pc1/pca1/pci1/pcn1/pcn241` parameter value. The value of this parameter is from 1 - 99.

:wt2 – The weight value assigned to the `pc2/pca2/pci2/pcn2/pcn242` parameter value. The value of this parameter is from 1 - 99.

:wt3 – The weight value assigned to the `pc3/pca3/pci3/pcn3/pcn243` parameter value. The value of this parameter is from 1 - 99.

:wt4 – The weight value assigned to the `pc4/pca4/pci4/pcn4/pcn244` parameter value.

:thr – The in-service threshold assigned to the MRN group or MRN set. The in-service threshold is the minimum percentage (from 1 - 100) of weight that must be available for an RC group (a group of entries in the MRN group or MRN set that have the same RC value assigned) to be considered available to carry traffic. If the percentage of the available weight is less than the in-service threshold, then the entire RC group is considered unavailable for traffic. If the percentage of the available weight is equal to or greater than the in-service threshold, then the RC group is considered available, and traffic can be sent to any available entity in the RC group. The value of the `thr` parameter is assigned to all entries that have the same RC (relative cost) value in the MRN group or MRN set that contain the point code specified in the `chg-mrn` command.

:force=yes – This parameter must be specified if the `rc/rc1/rc2/rc3/rc4` parameter is specified with the `wt/wt1/wt2/wt3/wt4` parameter.

The relative cost parameter values ($rc/rc1/rc2/rc3/rc4$) determine how the global title translation load is to be shared among the alternate point codes. There are three types of load sharing that can be performed: dominant, load shared, or combined dominant/load shared.

All the point codes in a dominant MRN group or MRN set have different relative cost values. The translated point code in the message is the preferred point code that the message is routed on. The relative cost value assigned to the preferred point code does not have to be the lowest value in the MRN group or MRN set. All traffic is routed to the preferred point code, if it is available. If the preferred point code becomes unavailable, the traffic is routed to highest priority alternate point code that is available. When the preferred point code becomes available again, the traffic is then routed back to the preferred point code. For example, the MRN table contains the following entries.

PC	RC
005-005-005	10
006-001-001	20
006-001-002	30
006-001-003	40
006-001-004	50
006-001-005	60
006-001-006	70
006-001-007	80

If the preferred point code is 006-001-001 and it becomes unavailable, the traffic will be routed to point code 006-001-002.

All the point codes in a load shared MRN group have the same relative cost value. Traffic is shared equally between the point codes in this MRN group.

A combined dominant/load shared MRN group or MRN set is a combination of the dominant and load sharing MRN groups or MRN sets. A combined dominant/load shared MRN group or MRN set must contain a minimum of two entries with the same relative cost value and a minimum of one entry with a different relative cost value. Traffic is routed to the point code or point codes with the lowest relative cost value. If more than one point code has the lowest relative cost value, the traffic is shared between these point codes. If the point code or point codes with the lowest relative cost value become unavailable, traffic is routed to the the point code or point codes with the next higher relative cost value. If more than one point code has this relative cost value, the traffic is shared between these point codes. For example, the MRN table contains the following entries.

PC	RC
005-005-005	10
006-001-001	10
006-001-002	10
006-001-003	20
006-001-004	20
006-001-005	20
006-001-006	20
006-001-007	20

If the preferred point code is 006-001-001, the traffic is shared equally between point codes 005-005-005, 006-001-001, and 006-001-002. If point codes 005-005-005, 006-001-001, and 006-001-002 become unavailable, the traffic will be shared equally

between point codes, 006-001-003, 006-001-004, 006-001-005, 006-001-006, and 006-001-007.

Specifying the `grpwt` or `thr` parameter with the `chg-mrn` command can be done when specifying only the `pc/pca/pci/pcn/pcn24` parameter and without the alternate point code, relative cost (`rc`, `rc1`, `rc2`, `rc3`, `rc4`), and individual weight (`wt`, `wt1`, `wt2`, `wt3`, `wt4`) parameters.

The weight values assigned to the entires in the MRN group or MRN set are shown in the `WT` column in the `rtrv-mrn` output.

The in-service threshold values assigned to the entires in the MRN group or MRN set are shown in the `THR` column in the `rtrv-mrn` output.

The `%WT` column in the `rtrv-mrn` output shows the percentage of the traffic the particular entry in the entity set will handle.

The `WT`, `%WT`, and `THR` columns are shown in the `rtrv-mrn` output only if the Weighted GTT Load Sharing feature is enabled and turned on.

For more information on the Weighted GTT Load Sharing feature, refer to [Weighted GTT Load Sharing](#).

Canceling the `RTRV-MRN` Command

Because the `rtrv-mrn` command used in this procedure can output information for a long period of time, the `rtrv-mrn` command can be canceled and the output to the terminal stopped. There are three ways that the `rtrv-mrn` command can be canceled.

- Press the `F9` function key on the keyboard at the terminal where the `rtrv-mrn` command was entered.
- Enter the `canc-cmd` without the `trm` parameter at the terminal where the `rtrv-mrn` command was entered.
- Enter the `canc-cmd:trm=<xx>`, where `<xx>` is the terminal where the `rtrv-mrn` command was entered, from another terminal other than the terminal where the `rtrv-mrn` command was entered. To enter the `canc-cmd:trm=<xx>` command, the terminal must allow Security Administration commands to be entered from it and the user must be allowed to enter Security Administration commands. The terminal's permissions can be verified with the `rtrv-secu-trm` command. The user's permissions can be verified with the `rtrv-user` or `rtrv-secu-user` commands.

For more information about the `canc-cmd` command, refer to *Commands User's Guide*.

1. Display the mated relay node groups in the database using the `rtrv-mrn` command. This is an example of the possible output.

```
rlghncxa03w 06-10-07 00:34:31 GMT EAGLE5 36.0.0
```

PC	RC	WT	%WT	THR
008-005-005	10	10	50	30
008-001-001	10	10	50	30
008-001-002	30	20	100	30
008-001-003	40	20	100	30
008-001-004	50	20	100	30

PC	RC	WT	%WT	THR
009-005-005	10	10	4	1
009-001-001	10	10	4	1
009-001-002	10	30	12	1
009-001-003	10	40	15	1
009-001-005	10	40	15	1
009-001-006	10	40	15	1
009-001-007	10	40	15	1
009-001-004	10	50	19	1
009-001-008	20	20	25	1
009-001-009	20	30	37	1
009-001-010	20	30	37	1

MRN table is (16 of 5990) 1% full

If the Flexible GTT Load Sharing feature is enabled, this is an example of the possible output.

rlghncxa03w 06-10-07 00:34:31 GMT EAGLE5 36.0.0

MRNSET	PC	RC	WT	%WT	THR
DFLT	005-005-005	10	10	50	30
	006-001-001	10	10	50	30
	006-001-002	30	20	100	30
	006-001-003	40	20	100	30
	006-001-004	50	20	100	30

MRNSET	PC	RC	WT	%WT	THR
1	005-005-005	10	10	4	1
	006-001-001	10	10	4	1
	006-001-002	10	30	12	1
	006-001-003	10	40	15	1
	006-001-005	10	40	15	1
	006-001-006	10	40	15	1
	006-001-007	10	40	15	1
	006-001-004	10	50	19	1
	006-001-008	20	20	25	1
	006-001-009	20	30	37	1
	006-001-010	20	30	37	1

MRN table is (16 of 5990) 1% full

2. Change the attributes of the MRN group or MRN set using the `chg-mrn` command in one or more of the following steps.

To change only the in-service threshold value of the entires in the RC group - perform step 3.

To change the weight values of all entries in an RC group or to change the weight and in-service threshold values of the entries in the RC group - perform step 5.

To change the individual weight values of entries in an MRN group or MRN set - perform step 7.

To change the individual weight values and RC values of entries in an MRN group or MRN set - perform step 9.

3. The in-service threshold value is changed by specifying the `thr` parameter. The `thr` parameter can be specified by itself only if the MRN set or MRN group currently has weight values assigned.

The new `thr` value is assigned to all entries in the MRN group or MRN set that have the same RC value as the specified point code.

For this example, enter one of these commands.

To change the in-service threshold value of all entries in the MRN group that have the same RC value as the point code specified in this step without the Flexible GTT Load Sharing feature enabled, enter this command.

```
chg-mrn:pca=008-001-001:thr=50
```

To change the in-service threshold value of all entries in the MRN set that have the same RC value as the point code specified in this step with the Flexible GTT Load Sharing feature enabled, enter this command.

```
chg-mrn:pca=006-001-001:thr=30:mrnset=1
```

When the `chg-mrn` command has successfully completed, this message should appear.

```
rlghncxa03w 06-10-07 11:44:13 GMT EAGLE5 36.0.0
CHG-MRN: MASP A - COMPLTD
```

4. Verify the changes using the `rtrv-mrn` command with the point code (`pca/pci/pcn/pcn24` parameters) specified in step 3. If the `mrnset` parameter was specified in step 3, the `mrnset` parameter and value specified in step 3 must be specified with the `rtrv-mrn` command in this step.

For this example, enter these commands.

```
rtrv-mrn:pca=008-001-001
```

The following example is the configuration of the MRN group before step 3 was performed.

```
rlghncxa03w 06-10-07 00:34:31 GMT EAGLE5 36.0.0
```

PC	RC	WT	%WT	THR
008-005-005	10	10	50	30
008-001-001	10	10	50	30
008-001-002	30	20	100	30
008-001-003	40	20	100	30
008-001-004	50	20	100	30

```
MRN table is (16 of 5990) 1% full
```

This is an example of the possible output after step 3 was performed.

```
rlghncxa03w 06-10-07 00:34:31 GMT EAGLE5 36.0.0
```

PC	RC	WT	%WT	THR
008-005-005	10	10	50	50
008-001-001	10	10	50	50

```
008-001-002    30 20 100 30
008-001-003    40 20 100 30
008-001-004    50 20 100 30
```

MRN table is (16 of 5990) 1% full

If the in-service threshold value was changed in an MRN set in step 3, this is an example of the possible output.

```
rtrv-mrn:pca=006-001-001:mrnset=1
```

The following example is the configuration of the MRN group before step 3 was performed.

```
rlghncxa03w 06-10-07 00:34:31 GMT EAGLE5 36.0.0
```

MRNSET	PC	RC	WT	%WT	THR
1	005-005-005	10	10	4	1
	006-001-001	10	10	4	1
	006-001-002	10	30	12	1
	006-001-003	10	40	15	1
	006-001-005	10	40	15	1
	006-001-006	10	40	15	1
	006-001-007	10	40	15	1
	006-001-004	10	50	19	1
	006-001-008	20	20	25	1
	006-001-009	20	30	37	1
	006-001-010	20	30	37	1

MRN table is (16 of 5990) 1% full

This is an example of the possible output after step 3 was performed.

```
rlghncxa03w 06-10-07 00:34:31 GMT EAGLE5 36.0.0
```

MRNSET	PC	RC	WT	%WT	THR
1	005-005-005	10	10	4	30
	006-001-001	10	10	4	30
	006-001-002	10	30	12	30
	006-001-003	10	40	15	30
	006-001-005	10	40	15	30
	006-001-006	10	40	15	30
	006-001-007	10	40	15	30
	006-001-004	10	50	19	30
	006-001-008	20	20	25	1
	006-001-009	20	30	37	1
	006-001-010	20	30	37	1

MRN table is (16 of 5990) 1% full

After this step has been performed, go to step 11.

5. An RC group is a group of point code entries that have the same RC value. This step is used to change the weight values of all the point codes in an MRN group

or MRN set that have the same RC value to the same weight value using the `chg-mrn` command with the `grpwt` parameter.

A load shared MRN group or MRN set can be considered an RC group as all the entries in the group or set have the same RC value, but changing all the weight values in a load shared group or set to the same weight value can be accomplished by using the `eswt` parameter as described in [Changing MRN Entries with the ESWT Parameter](#).

The in-service threshold value of the MRN group or MRN set can be changed by specifying the `thr` parameter with the `chg-mrn` command.

For this example, enter one of these commands.

To change only weight values of all entries in an RC group of the MRN group without the Flexible GTT Load Sharing feature enabled, enter this command.

```
chg-mrn:pca=009-005-005:grpwt=30
```

To change the weight and in-service threshold values of all entries in an RC group of the MRN group without the Flexible GTT Load Sharing feature enabled, enter this command.

```
chg-mrn:pca=009-005-005:grpwt=20:thr=30
```

To change only weight values of all entries in an RC group of the MRN set with the Flexible GTT Load Sharing feature enabled, enter this command.

```
chg-mrn:pca=005-005-005:grpwt=30:mrnset=1
```

To change the weight and in-service threshold values of all entries in an RC group of the MRN set with the Flexible GTT Load Sharing feature enabled, enter this command.

```
chg-mrn:pca=005-005-005:grpwt=20:thr=30:mrnset=1
```

If the MRN group or MRN set did not have weight and in-service threshold values assigned before this step was performed, and the `thr` parameter is not specified in this step, the in-service threshold value 1 (1%) is assigned to the entries.

When the `chg-mrn` command has successfully completed, this message should appear.

```
rlghncxa03w 06-10-07 11:44:13 GMT EAGLE5 36.0.0
CHG-MRN: MASP A - COMPLTD
```

- Verify the changes using the `rtrv-mrn` command with the point code (`pca/pci/pcn/pcn24` parameters) specified in step 5. If the `mrnset` parameter was specified in step 5, the `mrnset` parameter and value specified in step 5 must be specified with the `rtrv-mrn` command in this step.

For this example, enter these commands.

```
rtrv-mrn:pca=009-005-005
```

The following example is the configuration of the MRN group before step 5 was performed.

```
rlghncxa03w 06-10-07 00:34:31 GMT EAGLE5 36.0.0
```

PC	RC	WT	%WT	THR
009-005-005	10	10	4	1

009-001-001	10	10	4	1
009-001-002	10	30	12	1
009-001-003	10	40	15	1
009-001-005	10	40	15	1
009-001-006	10	40	15	1
009-001-007	10	40	15	1
009-001-004	10	50	19	1
009-001-008	20	20	25	1
009-001-009	20	30	37	1
009-001-010	20	30	37	1

MRN table is (16 of 5990) 1% full

This is an example of the possible output after step 5 was performed to change only the weight values.

rlghncxa03w 06-10-07 00:34:31 GMT EAGLE5 36.0.0

PC	RC	WT	%WT	THR
009-005-005	10	30	13	1
009-001-001	10	30	13	1
009-001-002	10	30	13	1
009-001-003	10	30	13	1
009-001-005	10	30	13	1
009-001-006	10	30	13	1
009-001-007	10	30	13	1
009-001-004	10	30	13	1
009-001-008	20	20	25	1
009-001-009	20	30	37	1
009-001-010	20	30	37	1

MRN table is (16 of 5990) 1% full

This is an example of the possible output after step 5 was performed to change the weight and in-service threshold values.

rlghncxa03w 06-10-07 00:34:31 GMT EAGLE5 36.0.0

PC	RC	WT	%WT	THR
009-005-005	10	20	13	30
009-001-001	10	20	13	30
009-001-002	10	20	13	30
009-001-003	10	20	13	30
009-001-005	10	20	13	30
009-001-006	10	20	13	30
009-001-007	10	20	13	30
009-001-004	10	20	13	30
009-001-008	20	20	25	1
009-001-009	20	30	37	1
009-001-010	20	30	37	1

MRN table is (16 of 5990) 1% full

If the weight values were changed in an MRN set in step 5, this is an example of the possible output.

```
rtrv-mrn:pca=005-005-005:mrnset=1
```

The following example is the configuration of the MRN set before step 5 was performed.

```
rlghncxa03w 06-10-07 00:34:31 GMT EAGLE5 36.0.0
```

MRNSET	PC	RC	WT	%WT	THR
1	005-005-005	10	10	4	1
	006-001-001	10	10	4	1
	006-001-002	10	30	12	1
	006-001-003	10	40	15	1
	006-001-005	10	40	15	1
	006-001-006	10	40	15	1
	006-001-007	10	40	15	1
	006-001-004	10	50	19	1
	006-001-008	20	20	25	1
	006-001-009	20	30	37	1
	006-001-010	20	30	37	1

```
MRN table is (16 of 5990) 1% full
```

This is an example of the possible output after step 5 was performed to change only the weight values.

```
rlghncxa03w 06-10-07 00:34:31 GMT EAGLE5 36.0.0
```

MRNSET	PC	RC	WT	%WT	THR
1	005-005-005	10	30	13	1
	006-001-001	10	30	13	1
	006-001-002	10	30	13	1
	006-001-003	10	30	13	1
	006-001-005	10	30	13	1
	006-001-006	10	30	13	1
	006-001-007	10	30	13	1
	006-001-004	10	30	13	1
	006-001-008	20	20	25	1
	006-001-009	20	30	37	1
	006-001-010	20	30	37	1

```
MRN table is (16 of 5990) 1% full
```

This is an example of the possible output after step 5 was performed to change the weight and in-service threshold values.

MRNSET	PC	RC	WT	%WT	THR
1	005-005-005	10	20	13	30
	006-001-001	10	20	13	30
	006-001-002	10	20	13	30
	006-001-003	10	20	13	30

```

006-001-005    10 20 13 30
006-001-006    10 20 13 30
006-001-007    10 20 13 30
006-001-004    10 20 13 30
006-001-008    20 20 25 1
006-001-009    20 30 37 1
006-001-010    20 30 37 1

```

MRN table is (16 of 5990) 1% full

After this step has been performed, go to step 11.

- Change the individual weight values of the MRN group or MRN set by entering the `chg-mrn` command with the point code parameters and their corresponding weight parameters `wt`, `wt1`, `wt2`, `wt3`, and `wt4` parameters.

The `thr` parameter cannot be specified with the `wt`, `wt1`, `wt2`, `wt3`, and `wt4` parameters.

For this example, enter one of these commands.

To change the individual weight values of the entries in the MRN group without the Flexible GTT Load Sharing feature enabled, enter this command.

```
chg-mrn:pca=008-005-005:wt=30:pca1=008-001-001:wt1=50
```

To change the individual weight values of the entries in the MRN set with the Flexible GTT Load Sharing feature enabled, enter this command.

```

chg-
mrn:pca=005-005-005:wt=30:pca1=006-001-001:wt1=20:pca2=006-00
1-002 :wt2=50:pca3=006-001-003:wt3=10:pca4=006-001-006:wt4=80
:mrnset=1

```

When the `chg-mrn` command has successfully completed, this message should appear.

```

rlghncxa03w 06-10-07 11:44:13 GMT EAGLE5 36.0.0
CHG-MRN: MASP A - COMPLTD

```

- Verify the changes using the `rtrv-mrn` command with the point code (`pca/pci/pcn/pcn24` parameters) specified in step 13.

If the `mrnset` parameter was specified in step 13, the `mrnset` parameter and value specified in step 13 must be specified with the `rtrv-mrn` command in this step.

For this example, enter these commands.

```
rtrv-mrn:pca=008-005-005
```

The following example is the configuration of the MRN group before step 7 was performed.

```
rlghncxa03w 06-10-07 00:34:31 GMT EAGLE5 36.0.0
```

```

PC          RC WT %WT THR
008-005-005 10 10 50 30
008-001-001 10 10 50 30
008-001-002 30 20 100 30

```

```
008-001-003    40 20 100 30
008-001-004    50 20 100 30
```

MRN table is (16 of 5990) 1% full

This is an example of the possible output after step 7 was performed.

```
rlghncxa03w 06-10-07 00:34:31 GMT EAGLE5 36.0.0
```

```
PC              RC WT %WT THR
008-005-005    10 30 37 30
008-001-001    10 50 62 30
008-001-002    30 20 100 30
008-001-003    40 20 100 30
008-001-004    50 20 100 30
```

MRN table is (16 of 5990) 1% full

If individual weight values were changed in an MRN set in step 7, this is an example of the possible output.

```
rtrv-mrn:pca=005-005-005:mrnset=1
```

The following example is the configuration of the MRN set before step 7 was performed.

```
rlghncxa03w 06-10-07 00:34:31 GMT EAGLE5 36.0.0
```

```
MRNSET  PC              RC WT %WT THR
1        005-005-005    10 10 4 1
         006-001-001    10 10 4 1
         006-001-002    10 30 12 1
         006-001-003    10 40 15 1
         006-001-005    10 40 15 1
         006-001-006    10 40 15 1
         006-001-007    10 40 15 1
         006-001-004    10 50 19 1
         006-001-008    20 20 25 1
         006-001-009    20 30 37 1
         006-001-010    20 30 37 1
```

MRN table is (16 of 5990) 1% full

This is an example of the possible output after step 7 was performed.

```
rlghncxa03w 06-10-07 00:34:31 GMT EAGLE5 36.0.0
```

```
MRNSET  PC              RC WT %WT THR
1        006-001-003    10 10 3 1
         006-001-001    10 20 6 1
         005-005-005    10 30 9 1
         006-001-005    10 40 13 1
         006-001-007    10 40 13 1
         006-001-002    10 50 15 1
```

```

006-001-004    10 50 15 1
006-001-006    10 80 25 1
006-001-008    20 20 25 1
006-001-009    20 30 37 1
006-001-010    20 30 37 1

```

MRN table is (16 of 5990) 1% full

After this step has been performed, go to step 11.

9. Change the individual weight values and RC values of the MRN group or MRN set by entering the `chg-mrn` command with the point code parameters and their corresponding RC parameters (`rc`, `rc1`, `rc2`, `rc3`, and `rc4`) and weight parameters (`wt`, `wt1`, `wt2`, `wt3`, and `wt4`) parameters.

The `thr` parameter cannot be specified with the `wt`, `wt1`, `wt2`, `wt3`, and `wt4` parameters.

 **Note:**

If the RC values are changed so that the resulting MRN group or MRN set becomes a dominant MRN group or MRN set (the RC values are unique), the weight parameters can be specified with the `chg-mrn` command, but the `WT`, `%WT`, and `THR` values are removed from the MRN group or MRN set and are not displayed in the `rtrv-mrn` output.

The following types of changes can be performed in this step:

- Weight and RC values for individual entries
- Weight values for some entries and the RC values for other entries
- Combinations of weight and RC values for individual entries and weight values for some entries and RC values for other entries.

The following examples show these types of changes.

The following MRN group is being changed.

```

PC          RC WT %WT THR
002-002-002    1 5 20 1
002-002-003    1 5 20 1
002-002-004    1 5 20 1
002-002-005    1 5 20 1
002-002-006    1 5 20 1

```

To change the weight and RC values for individual entries in this example MRN group, enter this command.

```

chg-
mrn:pca=002-002-002:rc=10:wt=10:pca1=002-002-003:rc1=20 :wt1=
30:pca2=002-002-004:rc2=10:wt2=40:force=yes

```

The following shows the changes that were made in the example command.

PC	RC	WT	%WT	THR
002-002-005	1	5	50	1
002-002-006	1	5	50	1
002-002-004	10	40	80	1
002-002-002	10	10	20	1
002-002-003	20	30	100	1

To change the weight values for some entries and the RC values for other entries in this example MRN group, enter this command.

```
chg-
mrn:pca=002-002-002:wt=10:pca1=002-002-003:rc1=20 :pca2=002-0
02-004:wt2=40:force=yes
```

The following shows the changes that were made in the example command.

PC	RC	WT	%WT	THR
002-002-004	1	40	67	1
002-002-002	1	10	17	1
002-002-005	1	5	8	1
002-002-006	1	5	8	1
002-002-003	10	5	100	1

To make both types of changes in this example MRN group, enter this command.

```
chg-
mrn:pca=002-002-002:rc=10:pca1=002-002-003:rc1=20:wt1=30 :pca
2=002-002-004:wt2=40:pca3=002-002-005:wt3=40:rc3=20 :pca4=002
-002-006 :wt4=60:force=yes
```

The following shows the changes that were made in the example command.

PC	RC	WT	%WT	THR
002-002-004	1	40	40	1
002-002-006	1	60	60	1
002-002-002	10	5	100	1
002-002-005	20	40	57	1
002-002-003	20	30	43	1

The `force=yes` parameter must be specified with the `chg-mrn` command when the following parameter combinations are specified with the `chg-mrn` command:

- If the `rc` parameter and the `wt/wt1/wt2/wt3/wt4` parameters are specified with the `chg-mrn` command.
- If the `wt` parameter and the `rc/rc1/rc2/rc3/rc4` parameters are specified with the `chg-mrn` command.

For this example, enter one of these commands.

To change the individual weight and RC values of the entries in the MRN group without the Flexible GTT Load Sharing feature enabled, enter this command.

```
chg-
mrn:pca=008-005-005:wt=30:rc=20:pca1=008-001-001:wt1=50 :rc1=
40:force=yes
```

To change the individual weight and RC values of the entries in the MRN set with the Flexible GTT Load Sharing feature enabled, enter this command.

```
chg-
mrn:pca=005-005-005:rc=30:pca1=006-001-001:wt1=20:pca2=006-00
1-002 :wt2=50:rc2=30:pca3=006-001-003:wt3=10:rc3=40:pca4=006-
001-006 :wt4=80:rc4=40:mrnset=1:force=yes
```

When the `chg-mrn` command has successfully completed, this message should appear.

```
rlghncxa03w 06-10-07 11:44:13 GMT EAGLE5 36.0.0
CHG-MRN: MASP A - COMPLTD
```

10. Verify the changes using the `rtrv-mrn` command with the point code (`pca/pci/pcn/pcn24` parameters) specified in step 9. If the `mrnset` parameter was specified in step 9, the `mrnset` parameter and value specified in step 9 must be specified with the `rtrv-mrn` command in this step.

For this example, enter these commands.

```
rtrv-mrn:pca=008-005-005
```

The following example is the configuration of the MRN group before step 9 was performed.

```
rlghncxa03w 06-10-07 00:34:31 GMT EAGLE5 36.0.0
```

PC	RC	WT	%WT	THR
008-005-005	10	10	50	30
008-001-001	10	10	50	30
008-001-002	30	20	100	30
008-001-003	40	20	100	30
008-001-004	50	20	100	30

```
MRN table is (16 of 5990) 1% full
```

This is an example of the possible output after step 9 was performed.

```
rlghncxa03w 06-10-07 00:34:31 GMT EAGLE5 36.0.0
```

PC	RC	WT	%WT	THR
008-005-005	20	30	100	30
008-001-002	30	20	100	30
008-001-001	40	50	71	30
008-001-003	40	20	28	30
008-001-004	50	20	100	30

```
MRN table is (16 of 5990) 1% full
```

If individual weight and relative cost values were changed in an MRN set in step 9, this is an example of the possible output.

```
rtrv-mrn:pca=005-005-005:mrnset=1
```

The following example is the configuration of the MRN set before step 9 was performed.

```
rlghncxa03w 06-10-07 00:34:31 GMT EAGLE5 36.0.0
```

MRNSET	PC	RC	WT	%WT	THR
1	005-005-005	10	10	4	1
	006-001-001	10	10	4	1
	006-001-002	10	30	12	1
	006-001-003	10	40	15	1
	006-001-005	10	40	15	1
	006-001-006	10	40	15	1
	006-001-007	10	40	15	1
	006-001-004	10	50	19	1
	006-001-008	20	20	25	1
	006-001-009	20	30	37	1
	006-001-010	20	30	37	1

```
MRN table is (16 of 5990) 1% full
```

This is an example of the possible output after step 9 was performed.

```
rlghncxa03w 06-10-07 00:34:31 GMT EAGLE5 36.0.0
```

MRNSET	PC	RC	WT	%WT	THR
1	006-001-004	10	50	25	1
	006-001-002	10	50	25	1
	006-001-005	10	40	20	1
	006-001-007	10	40	20	1
	006-001-001	10	20	10	1
	006-001-009	20	30	37	1
	006-001-010	20	30	37	1
	006-001-008	20	20	25	1
	005-005-005	30	10	100	1
	006-001-006	40	80	88	1
	006-001-003	40	10	11	1

```
MRN table is (16 of 5990) 1% full
```

- Backup the new changes using the `chg-db:action=backup:dest=fixed` command. These messages should appear, the active Maintenance and Administration Subsystem Processor (MASP) appears first.

```
BACKUP (FIXED) : MASP A - Backup starts on active MASP.
```

```
BACKUP (FIXED) : MASP A - Backup on active MASP to fixed disk complete.
```

```
BACKUP (FIXED) : MASP A - Backup starts on standby MASP.
```

```
BACKUP (FIXED) : MASP A - Backup on standby MASP to fixed disk complete.
```

Figure 2-146 Change the Weight and Threshold Values of MRN Entries - Sheet 1 of 4

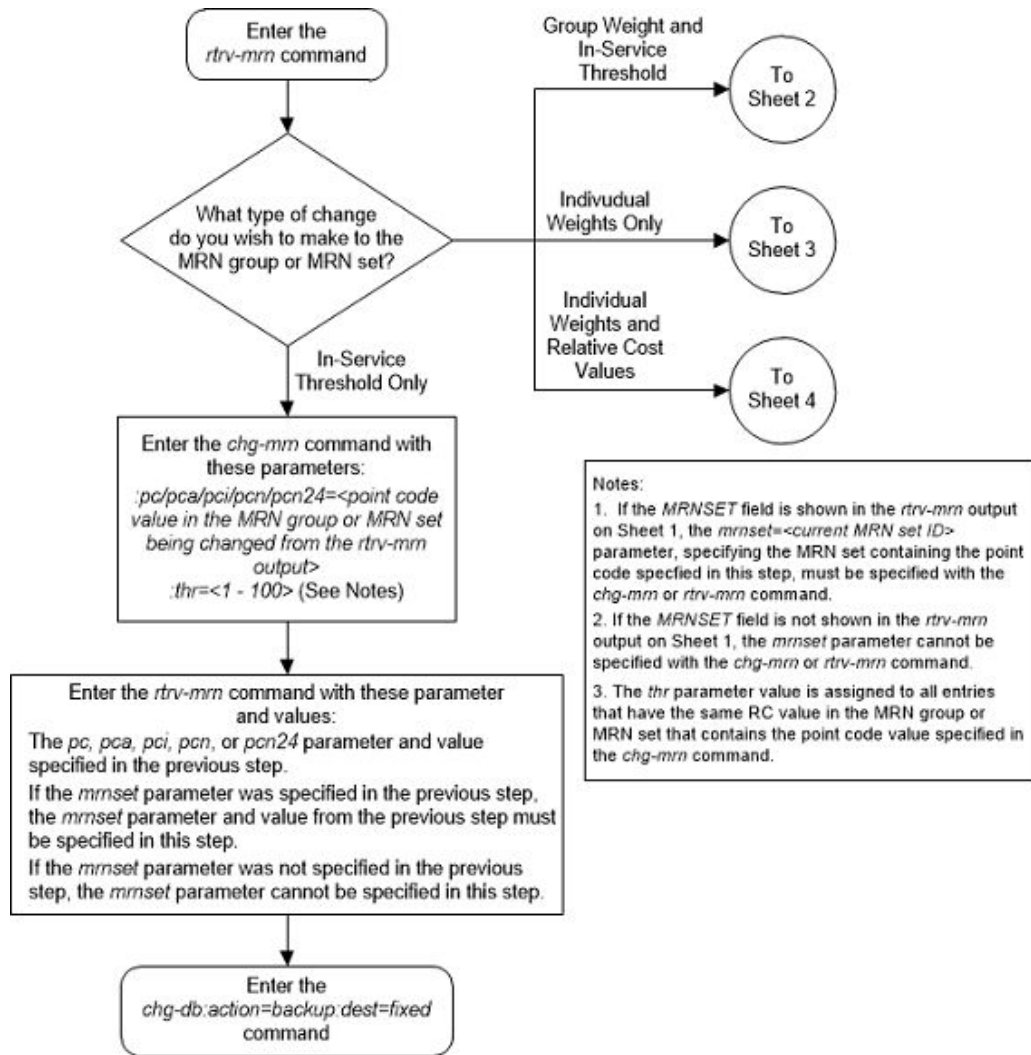

Figure 2-147 Change the Weight and Threshold Values of MRN Entries - Sheet 2 of 4

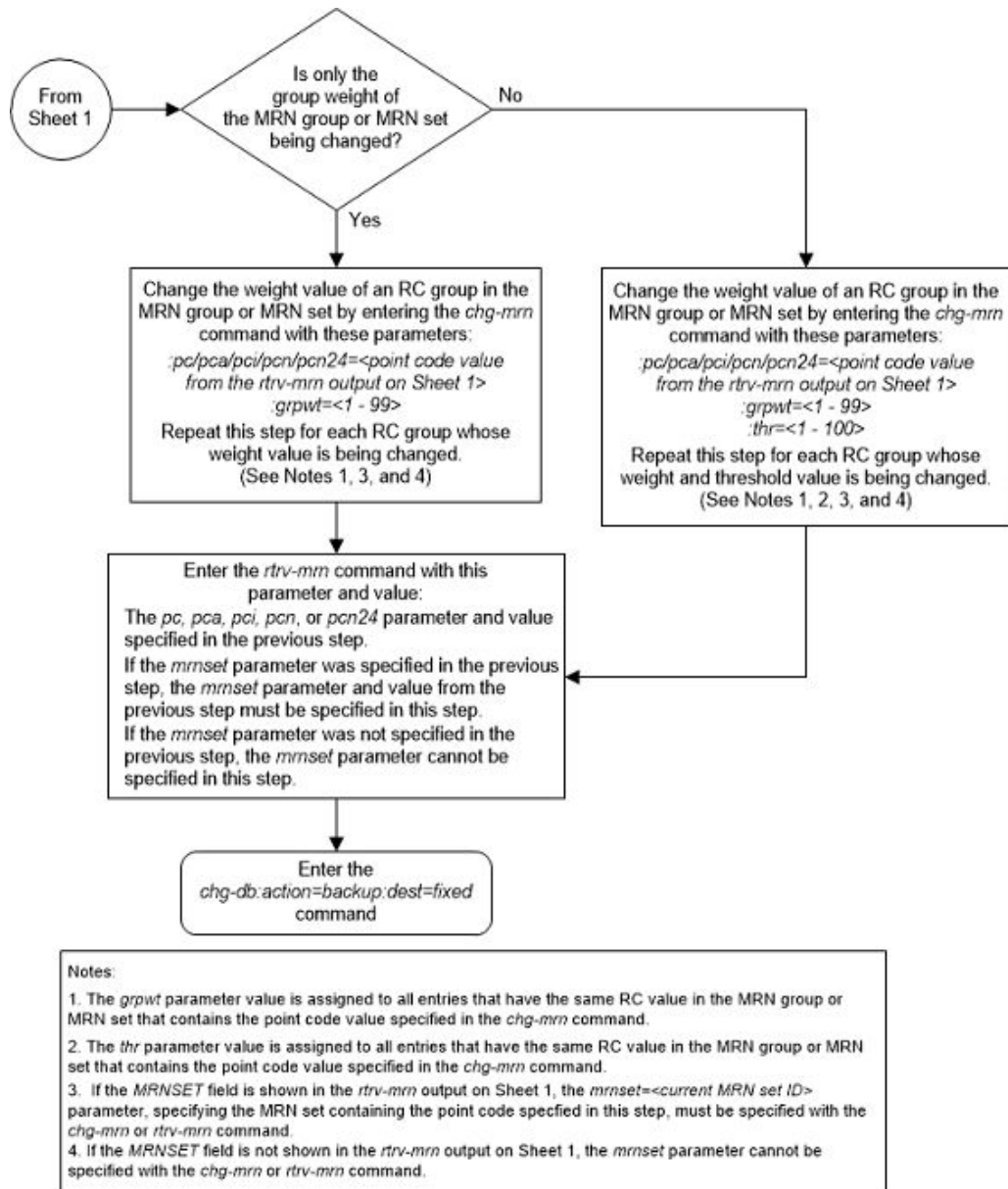

Figure 2-148 Change the Weight and Threshold Values of MRN Entries - Sheet 3 of 4

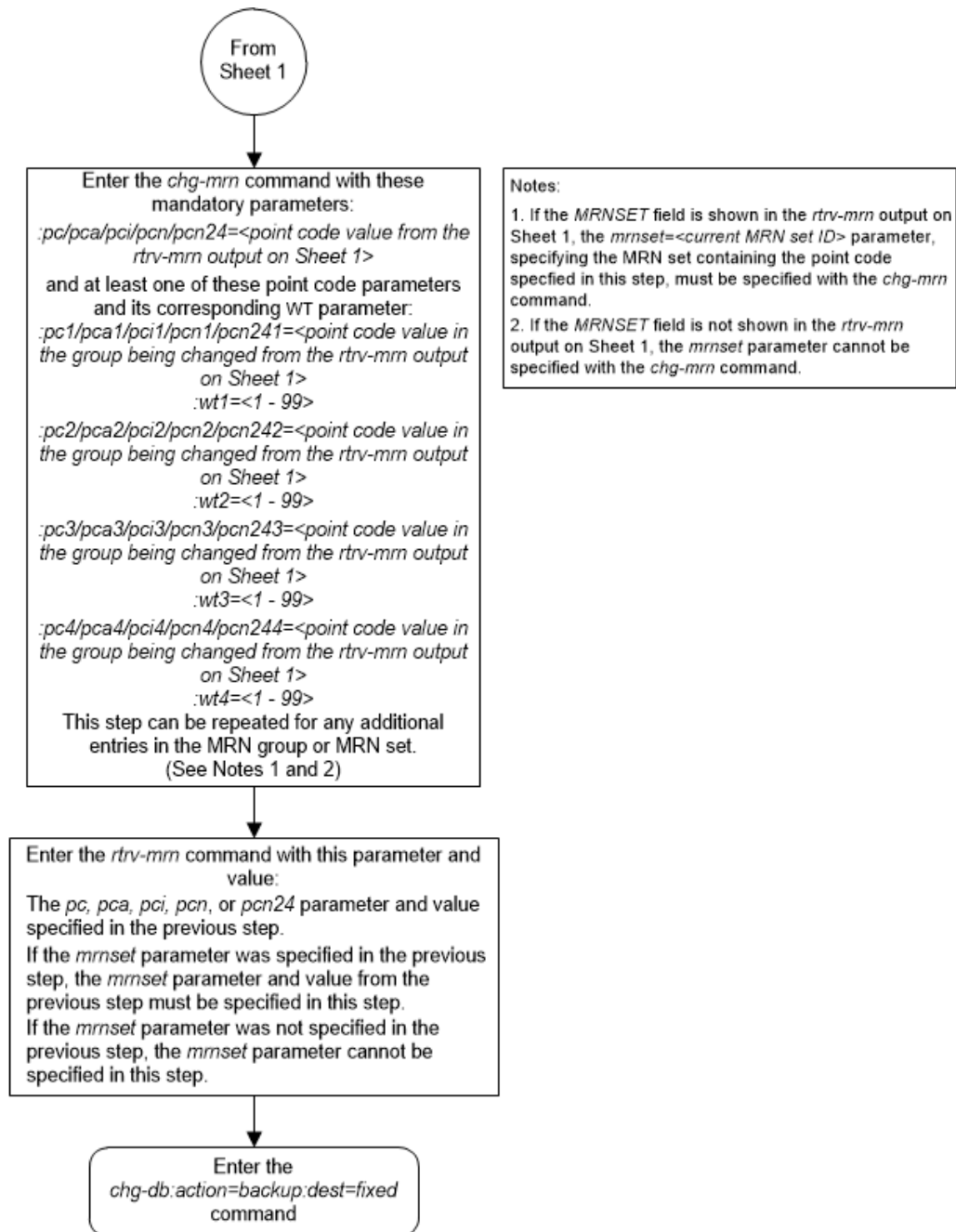
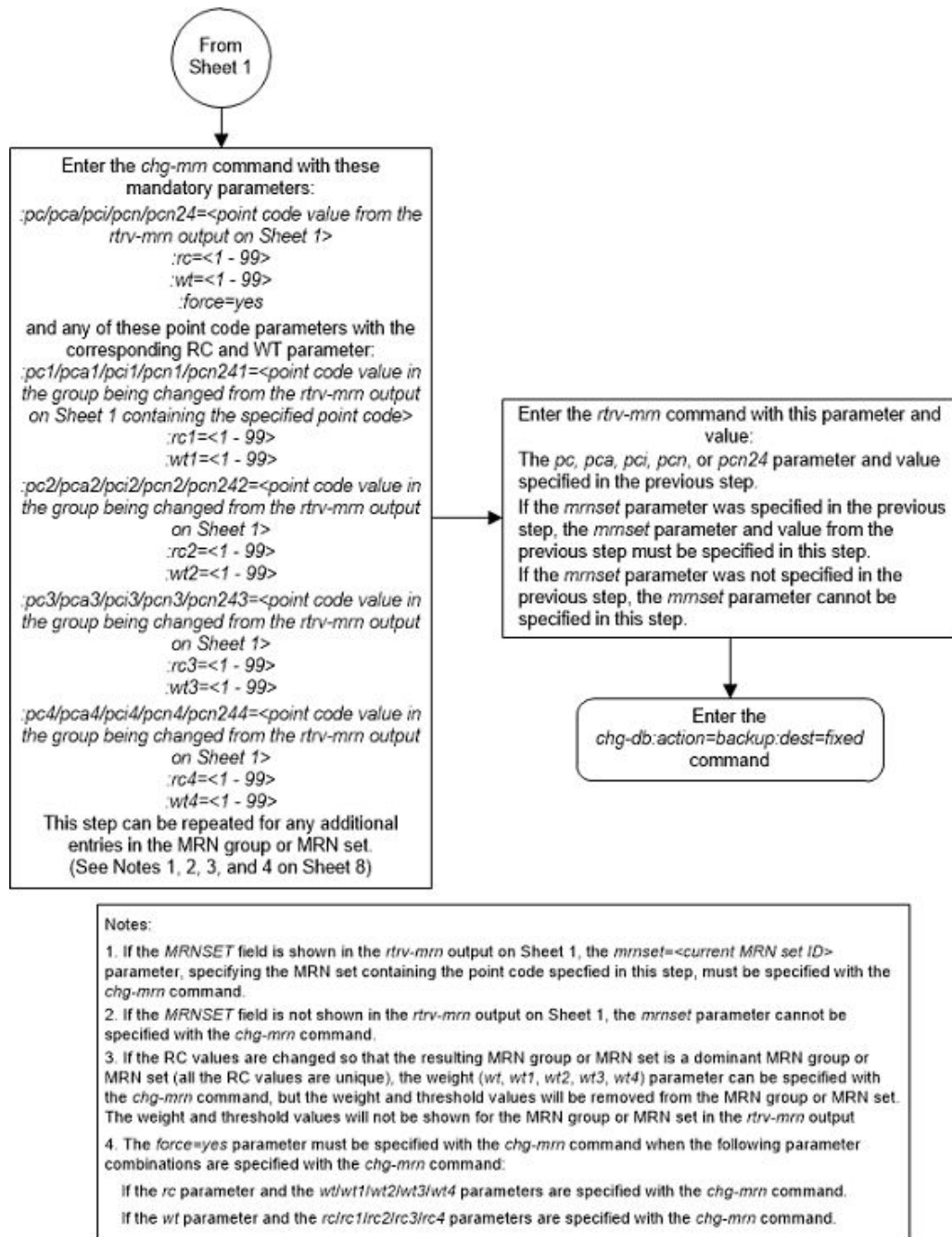

Figure 2-149 Change the Weight and Threshold Values of MRN Entries - Sheet 4 of 4



Changing the MAPSET, MAP Point Code, and MAP SSN Values of MRN Entries

This procedure is used to change the MAPSET, MAP point code, and MAP SSN values in an existing Mated Relay Node (MRN) set using the *mapset*, *mappc/mappca/mappci/mappcn/mappcn24*, and *mapssn* parameters of the *chg-mrn* command.

The `chg-mrn` command can also be used to add point code entries to an existing MRN set. This action is not covered in this procedure. If you wish to add point code entries to an existing MRN set, perform [Provisioning MRN Entries](#).

If you wish to assign the same weight and threshold value to all the entries in the MRN set with the `eswt` and `thr` parameters, or to remove the weight and threshold values from all the entries in the MRN set with the `eswt=none` parameter, perform [Changing MRN Entries with the ESWT Parameter](#). The `eswt` and `thr` parameters cannot be used in this procedure.

If you wish to change individual weight values for entries with the `wt/wt1/wt2/wt3/wt4` parameters, the weight values for an RC group with the `grpwt` parameter, the threshold values for an MRN set with the `thr` parameter, or the relative cost and weight values for an MRN set with the `force=yes` parameter, perform [Changing the Weight and Threshold Values of MRN Entries](#). The `wt/wt1/wt2/wt3/wt4`, `grpwt`, `thr`, and `force=yes` parameters cannot be used in this procedure.

These parameters are used with the `chg-mrn` command in this procedure.

`:pc/pca/pci/pcn/pcn24` – The point code in the message after intermediate global title translation has been performed.

`:mrnset` – The MRN set ID that is being changed.

`:mapset` – The MAP set ID that is being assigned to the MRN. This is the MAP set from which alternate routing indicator searches are performed.

`:mappc/mappca/mappci/mappcn/mappcn24` – The point code assigned to the `mapset` that is being assigned to the MRN set.

`:mapssn` – The subsystem number assigned to the point code in the MAP set that is being assigned to the MRN.

 **Note:**

Refer to Chapter 2, *Configuring Destination Tables in Database Administration - SS7 User's Guide* for a definition of the point code types that are used on the EAGLE and for a definition of the different formats that can be used for ITU national point codes.

The current values of the `mapset`, `:mappc/mappca/mappci/mappcn/mappcn24`, and `mapssn` parameters are shown in the `rtrv-mrn` output only if the Flexible GTT Load Sharing and the GTT Load Sharing with Alternate Routing Indicator features are enabled.

The new values for the `mapset`, `mappc/mappca/mappci/mappcn/mappcn24`, and `mapssn` parameters must be shown in the `rtrv-map` output.

The network type of the `pc/pca/pci/pcn/pcn24` and `mappc/mappca/mappci/mappcn/mappcn24` parameter values must be compatible, as shown in [Table 2-57](#).

Table 2-57 MRN and MAP Point Code Parameter Combinations

MRN Point Code Parameter	MAP Point Code Parameter
<code>pc/pca</code>	<code>mappc/mappca</code>

Table 2-57 (Cont.) MRN and MAP Point Code Parameter Combinations

MRN Point Code Parameter	MAP Point Code Parameter
pci or pcn (See Notes 1 and 2)	mappci or mappcn (See Notes 1 and 2)
pcn24	mappcn24
Notes:	
1. If the network type of the MRN point code parameter is ITU-I (pci), the network type of the MAP point code parameter can be either ITU-I (mappci) or ITU-N (mappcn).	
2. If the network type of the MRN point code parameter is ITU-N (pcn), the network type of the MAP point code parameter can be either ITU-I (mappci) or ITU-N (mappcn).	

Canceling the RTRV-MRN Command

Because the `rtrv-mrn` command used in this procedure can output information for a long period of time, the `rtrv-mrn` command can be canceled and the output to the terminal stopped. There are three ways that the `rtrv-mrn` command can be canceled.

- Press the F9 function key on the keyboard at the terminal where the `rtrv-mrn` command was entered.
- Enter the `canc-cmd` without the `trm` parameter at the terminal where the `rtrv-mrn` command was entered.
- Enter the `canc-cmd:trm=<xx>`, where `<xx>` is the terminal where the `rtrv-mrn` command was entered, from another terminal other than the terminal where the `rtrv-mrn` command was entered. To enter the `canc-cmd:trm=<xx>` command, the terminal must allow Security Administration commands to be entered from it and the user must be allowed to enter Security Administration commands. The terminal's permissions can be verified with the `rtrv-secu-trm` command. The user's permissions can be verified with the `rtrv-user` or `rtrv-secu-user` commands.

For more information about the `canc-cmd` command, refer to *Commands User's Guide*.

1. Display the mated relay node sets in the database using the `rtrv-mrn` command. This is an example of the possible output.

```
rlghncxa03w 09-02-07 00:34:31 GMT EAGLE5 40.1.0

MRNSET  PC          RC
DFLT    005-005-005    10
        006-001-001    20
        006-001-002    30
        006-001-003    40
        006-001-004    50
        006-001-005    60
        006-001-006    70
        006-001-007    80

MRNSET  PC          RC
1       007-007-007    10
        008-001-001    20
```

```

008-001-002    30
008-001-003    40
008-001-004    50
008-001-005    60
008-001-006    70

```

MRN table is (15 of 5990) 1% full

 **Note:**

If the Weighted GTT Load Sharing feature is enabled and turned on, the WT, %WT, and THR columns are shown in the `rtrv-mrn` output.

If the MAPSET, MAPPC, and MAPSSN columns are not shown in the `rtrv-mrn` output, the GTT Load Sharing with Alternate Routing Indicator feature is not enabled. Perform [Activating the GTT Load Sharing with Alternate Routing Indicator Feature](#) to enable the GTT Load Sharing with Alternate Routing Indicator feature. After [Activating the GTT Load Sharing with Alternate Routing Indicator Feature](#) has been performed, continue the procedure with 2.

If the MAPSET, MAPPC, and MAPSSN columns are shown in the `rtrv-mrn` output, the GTT Load Sharing with Alternate Routing Indicator feature is enabled. Continue the procedure with 2.

2. The MAP point code and MAP SSN values must be assigned to a MAP set. The MAP set must be shown in the `rtrv-map` output. Display the MAP sets by entering the `rtrv-map` command. This is an example of the possible output.

```
rlghncxa03w 09-07-07 00:34:31 GMT EAGLE5 41.1.0
```

```

MAPSET ID=DFLT   MRNSET ID=----   MRNPC=-----
PCA             Mate PCA       SSN RC MULT SRM MRC GRP NAME SSO
255-001-000                250 10  SOL *Y *Y  grp01  ON

```

```

MAPSET ID=1     MRNSET ID=----   MRNPC=-----
PCA             Mate PCA       SSN RC MULT SRM MRC GRP NAME SSO
255-001-000                251 10  SHR *Y *Y  grp01  OFF
253-001-002    254 10  SHR *Y *Y  grp01  OFF

```

```

MAPSET ID=2     MRNSET ID=----   MRNPC=-----
PCA             Mate PCA       SSN RC MULT SRM MRC GRP NAME SSO
255-001-000                252 10  SOL *Y *Y  grp01  ON

```

```

MAPSET ID=DFLT   MRNSET ID=----   MRNPC=-----
PCA             Mate PCA       SSN RC MULT SRM MRC GRP NAME SSO
255-001-000                253 10  SHR *Y *Y  grp01  OFF
253-001-004    254 10  SHR *Y *Y  grp01  OFF

```

```

MAPSET ID=3     MRNSET ID=----   MRNPC=-----
PCA             Mate PCA       SSN RC MULT SRM MRC GRP NAME SSO
255-001-001                255 10  DOM YES YES  grp01  ON
253-001-005    254 20  DOM YES YES  grp01  ON

```

```

MAPSET ID=4      MRNSET ID=---- MRNPC=-----
PCA             Mate PCA      SSN RC MULT SRM MRC GRP NAME SSO
255-001-001    253-001-001  250 10  DOM YES YES grp01  OFF
                254 20  DOM YES YES grp01  OFF

MAPSET ID=DFLT  MRNSET ID=---- MRNPC=-----
PCA             Mate PCA      SSN RC MULT SRM MRC GRP NAME SSO
255-001-002    253-001-002  251 10  SHR *Y *Y grp01  OFF
                254 10  SHR *Y *Y grp01  OFF

MAPSET ID=5      MRNSET ID=---- MRNPC=-----
PCA             Mate PCA      SSN RC MULT SRM MRC GRP NAME SSO
255-001-002    252-001-002  252 10  DOM YES YES grp01  ON
                254 20  DOM YES YES grp01  ON

MAPSET ID=6      MRNSET ID=---- MRNPC=-----
PCA             Mate PCA      SSN RC MULT SRM MRC GRP NAME SSO
255-001-002    253-001-002  253 10  SHR *Y *Y grp01  ON
                254 10  SHR *Y *Y grp01  ON

MAPSET ID=7      MRNSET ID=---- MRNPC=-----
PCA             Mate PCA      SSN RC MULT SRM MRC GRP NAME SSO
002-002-007    50 10  COM YES *Y grp01  OFF
002-002-008    30 10  COM YES *Y grp01  OFF
002-002-009    30 10  COM YES *Y grp01  OFF
002-002-010    30 20  COM YES *Y grp01  OFF
002-002-011    30 20  COM YES *Y grp01  OFF

MAPSET ID=8      MRNSET ID=---- MRNPC=-----
PCI             Mate PCI      SSN RC MULT SRM MRC GRP NAME SSO
2-001-2        255 10  DOM NO  YES grp03  OFF
                254 20  DOM NO  YES grp03  OFF

MAPSET ID=9      MRNSET ID=---- MRNPC=-----
PCN             Mate PCN      SSN RC MULT SRM MRC GRP NAME SSO
00347          253 10  SHR *N *N grp05  OFF
01387          254 10  SHR *N *N grp05  OFF

MAP TABLE IS (25 of 36000) 1 % FULL

```

 **Note:**

If the Weighted GTT Load Sharing feature is enabled and turned on, the WT, %WT, and THR columns are shown in the `rtrv-map` output.

If the MAP set that you wish to use, containing the desired point code and subsystem number, is shown in the `rtrv-map` output, continue the procedure with [3](#).

 **Note:**

The network type of the `pc/pca/pci/pcn/pcn24` and `mappc/mappca/mappci/mappcn/mappcn24` parameter values must be the same, as shown in [Table 2-57](#).

If the MAP set that you wish to use is not shown in the `rtrv-map` output, add the required MAP set by performing one of these procedures.

- [Provisioning a Solitary Mated Application](#)
- [Provisioning a Dominant Mated Application](#)
- [Provisioning a Load Shared Mated Application](#)
- [Provisioning a Combined Dominant/Load Shared Mated Application](#)

After the MAP set has been added, continue the procedure with [3](#).

3. Change the MAPSET, MAP point code, and MAP SSN values in the MRN set by entering the `chg-mrn` command with the `mapset`, `mappc/mappca/mappci/mappcn/mappcn24`, and `mapssn` parameters.

For this example, enter this command.

```
chg-
mrn:mrnset=1:pca=007-007-007:mapset=7:mappca=002-002-007:mapssn=50
```

When the `chg-mrn` command has successfully completed, this message should appear.

```
rlghncxa03w 09-02-07 11:44:13 GMT EAGLE5 40.1.0
CHG-MRN: MASP A - COMPLTD
```

4. Verify the changes using the `rtrv-mrn` command with the point code (`pca/pci/pcn/pcn24` parameters) and `mrnset` values specified in [3](#).

For this example, enter this command.

```
rtrv-mrn:mrnset=1:pca=007-007-007
```

This is an example of the possible output.

```
rlghncxa03w 09-02-07 00:34:31 GMT EAGLE5 40.1.0
```

MRNSET	MAPSET	MAPPC	MAPSSN	PC	RC
1	7	002-002-007	50	007-007-007	10
				008-001-001	20
				008-001-002	30
				008-001-003	40
				008-001-004	50
				008-001-005	60
				008-001-006	70

MRN table is (15 of 5990) 1% full

 **Note:**

If the Weighted GTT Load Sharing feature is enabled and turned on, the WT, %WT, and THR columns are shown in the `rtrv-mrn` output.

5. Backup the new changes using the `chg-db:action=backup:dest=fixed` command. These messages should appear, the active Maintenance and Administration Subsystem Processor (MASP) appears first.

```
BACKUP (FIXED) : MASP A - Backup starts on active MASP.  
BACKUP (FIXED) : MASP A - Backup on active MASP to fixed disk  
complete.  
BACKUP (FIXED) : MASP A - Backup starts on standby MASP.  
BACKUP (FIXED) : MASP A - Backup on standby MASP to fixed disk  
complete.
```

Figure 2-150 Change the MAPSET, MAP Point Code, and MAP SSN Values of MRN Entries - Sheet 1 of 2

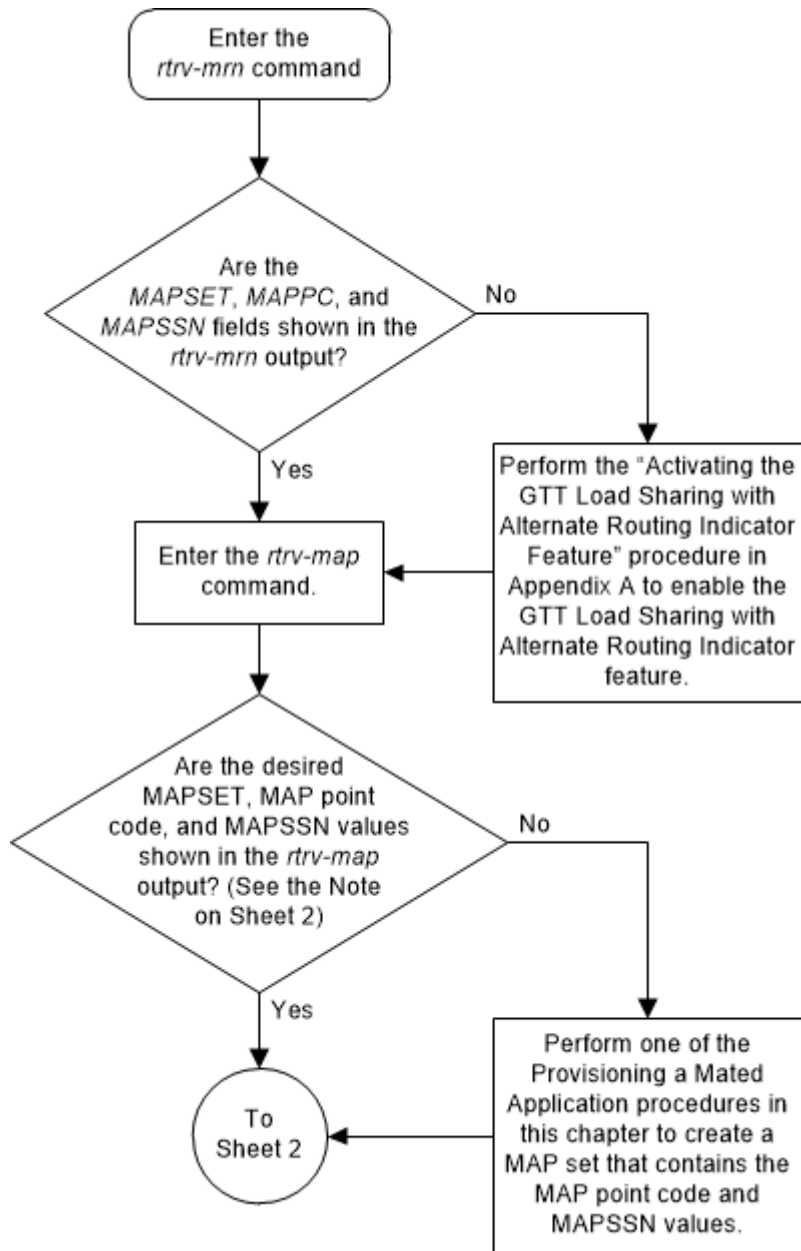
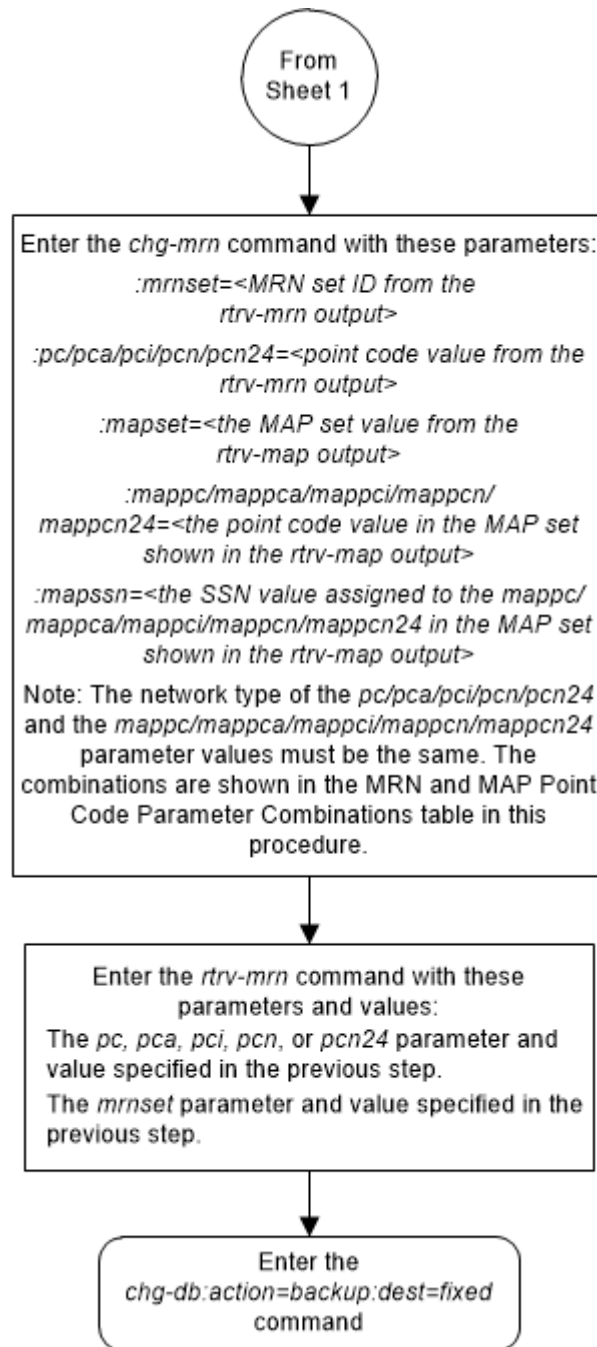

Figure 2-151 Change the MAPSET, MAP Point Code, and MAP SSN Values of MRN Entries - Sheet 2 of 2



Adding a GT Conversion Table Entry

This procedure is used to provision an entry in the GT Conversion table for the ANSI/ITU SCCP Conversion feature using the `ent-gtcnv` command.

The `ent-gtcnv` command uses these parameters.

`:dir` – The direction that the conversion takes place

`atoa` – The conversion takes place in the ANSI to ITU direction

`itoa` – The conversion takes place in the ITU to ANSI direction

`both` – The conversion takes place in the ANSI to ITU and ITU to ANSI directions

`:gtixlat` – The global title indicator types being converted.

`22` – ANSI GTI type 2 to ITU GTI type 2

`24` – ANSI GTI type 2 to ITU GTI type 4

`:tta` – The ANSI translation type

`:tti` – The ITU translation type

`:np` – The numbering plan

`:nai` – The nature of address indicator

`:npdd` – The number of digits to be deleted or substituted from the beginning of the Global Title Address digits (the prefix digits)

`:npds` – The digits that are being substituted for the prefix digits

`:nsdd` – The number of digits to be deleted or substituted from the end of the Global Title Address digits (the suffix digits)

`:nsds` – The digits that are being substituted for the suffix digits

To perform this procedure, the ANSI/ITU SCCP Conversion feature must be enabled. Enter the `rtrv-ctrl-feat` command to verify whether or not the ANSI/ITU SCCP Conversion is enabled. If the ANSI/ITU SCCP Conversion feature is not enabled, perform the [Activating the ANSI/ITU SCCP Conversion Feature](#) procedure to enable the ANSI/ITU SCCP Conversion feature.

 **Note:**

The ANSI/ITU SCCP Conversion feature can only be permanently enabled.

The `gtixlat` parameter determines how the `tta`, `tti`, `np`, and `nai` parameters are used with the `ent-gtcnv` command.

If the `gtixlat` parameter value is 22, only the `tta`, `tti`, `npdd`, `npds`, `nsdd`, and `nsds` parameters can be specified. The `tta` and `tti` parameters must be specified along with the `dir` and `gtixlat=22` parameters.

If the `gtixlat` parameter value is 24, the `tta`, `tti`, `np`, `nai`, `npdd`, `npds`, `nsdd`, and `nsds` parameters can be specified. The `tta`, `tti`, `np`, and `nai` parameters must be specified along with the `dir` and `gtixlat=24` parameters.

Asterisks (*) can be specified for the `tta`, `tti`, `np`, and `nai` parameters indicating all possible values for that parameter. The `dir` and `gtixlat` parameters determine when the asterisk can be used.

If the `dir` parameter is `atoi`, the asterisk can be specified only for the `tta` parameter.

If the `dir` parameter is `itoa` and the `gtixlat` parameter is 24, the asterisk can be specified for the `tti`, `np`, and `nai` parameters. If the asterisk is specified for either the `tti`, `np`, or `nai` parameters, the asterisk must be specified for the `tti`, `np`, and `nai` parameters.

The asterisk cannot be specified for any parameter when the `dir` parameter value is both.

The optional prefix (`npdd`, `npds`) and suffix parameters (`nsdd`, `nsds`) can be specified, but both sets of parameters, or a mixture of the prefix and suffix parameters cannot be specified. For example, if either the `npdd` or `npds` parameters are specified, the `nsdd` and `nsds` cannot be specified. If either the `nsdd` or `nsds` parameters are specified, the `npdd` and `npds` parameters cannot be specified.

1. Verify the status of the ANSI/ITU SCCP Conversion feature by entering the `rtrv-ctrl-feat` command with the ANSI/ITU SCCP Conversion feature part number. Enter this command.

```
rtrv-ctrl-feat:partnum=893012001
```

The following is an example of the possible output.

```
rlghncxa03w 06-10-28 21:15:37 GMT EAGLE5 36.0.0
The following features have been permanently enabled:
```

Feature Name	Partnum	Status	Quantity
SCCP Conversion	893012010	on	----

The following features have been temporarily enabled:

Feature Name	Partnum	Status	Quantity	Trial
Period Left				
Zero entries found.				

The following features have expired temporary keys:

Feature Name	Partnum
Zero entries found.	

If the ANSI/ITU SCCP Conversion feature has not been enabled, perform the [Activating the ANSI/ITU SCCP Conversion Feature](#) procedure to enable this feature.

2. Display the GT Conversion Table entries by entering the `rtrv-gtcnv` command. The following is an example of the possible output.

```
rlghncxa03w 06-10-28 21:15:37 GMT EAGLE5 36.0.0
DIR  GTIXLAT  TTA  TTI  NP  NAI  DEL  POS  ADD
atoi  22      24  12  --- --- --- --- ---
itoa   22      2   5   --- --- --- --- ---
itoa   24      3   6   4   8   --- --- ---
itoa   24      4   7   4   8   3   sfx 123
atoi   24      5   7   4   8   3   sfx 123
atoi   22      7   8   --- --- 3   sfx 123
both   24      8   9   4   8   4   pfx 4567
both   22      9  11  --- --- --- --- ---
```

GTCNV table is (8 of 1000) 1% full

3. Add the new GT Conversion Table entry by entering the `ent-gtcnv` command with the appropriate parameter combinations shown in [Table 2-58](#).

Table 2-58 GT Conversion Parameter Combinations

DIR = ATOI		DIR = ITOA		DIR = BOTH	
GTIXLAT = 22	GTIXLAT = 24	GTIXLAT = 22	GTIXLAT = 24	GTIXLAT = 22	GTIXLAT = 24
TTA = 0-255	TTA = 0-255	TTA = 0-255	TTA = 0-255	TTA = 0-255	TTA = 0-255
or	or	TTI = 0-255	TTI = 0-255 & NP = 0-15 & NAI = 0-63	TTI = 0-255	TTI = 0-255
TTA = *	TTA = *		or		NP = 0-15
TTI = 0-255	TTI = 0-255		TTI = * & NP = * & NAI = *		NAI = 0-63
	NP = 0-15				
	NAI = 0-63				
Optional Parameters					
NPDD = 0-21 & NPDS = 1 - 21 digits		NPDD = 0-21 & NPDS = 1 - 21 digits		NPDD = 0-21 & NPDS = 1 - 21 digits	
or		or		or	
NSDD = 0-21 & NSDS = 1 - 21 digits		NSDD = 0-21 & NSDS = 1 - 21 digits		NSDD = 0-21 & NSDS = 1 - 21 digits	

For this example, enter these commands.

```
ent-gtcnv:dir=atoi:gtixlat=22:tta=10:tti=43:npdd=3:npds=919
ent-gtcnv:dir=atoi:gtixlat=24:tta=*:tti=29:np=4:nai=87
ent-gtcnv:dir=ittoi:gtixlat=22:tta=23:tti=57:nsdd=3:nsds=800
ent-gtcnv:dir=ittoi:gtixlat=24:tta=33:tti=66:np=3:nai=33
ent-gtcnv:dir=ittoi:gtixlat=24:tta=44:tti=*:np=*:nai=*
ent-gtcnv:dir=both:gtixlat=22:tta=26:tti=13
ent-
gtcnv:dir=both:gtixlat=24:tta=37:tti=59:np=3:nai=33:npdd=3:npds=423
```

When each of these commands have successfully completed, the following message should appear.

```
rlghncxa03w 06-10-28 21:15:37 GMT EAGLE5 36.0.0
ENT-GTCNV: MASP A - COMPLTD
```

4. Verify the changes using the `rtrv-gtcnv` command and specifying the following parameters based on the `gtixlat` parameter values used in step 3.
 - a. `gtixlat=22`
 - `dir` = value specified in step 3
 - `tta` = value specified in step 3

- tti = value specified in step 3
- b.** gtixlat=24
 - dir = value specified in step 3
 - tta = value specified in step 3
 - tti = value specified in step 3
 - np = value specified in step 3
 - nai = value specified in step 3

For this example, enter these commands.

```
rtrv-gtcnv:dir=atoi:gtixlat=22:tta=10:tti=43
```

This is an example of the possible output.

```
rlghncxa03w 06-10-28 21:15:37 GMT EAGLE5 36.0.0
DIR  GTIXLAT  TTA  TTI  NP  NAI  DEL  POS  ADD
atoi  22    10  43  --- ---  3   pfx  919
```

GTCNV table is (15 of 1000) 1% full

```
rtrv-gtcnv:dir=atoi:gtixlat=24:tta=*:tti=29:np=4:nai=87
```

This is an example of the possible output.

```
rlghncxa03w 06-10-28 21:15:37 GMT EAGLE5 36.0.0
DIR  GTIXLAT  TTA  TTI  NP  NAI  DEL  POS  ADD
atoi  24     *   29  4   87  --- ---  ---
```

GTCNV table is (15 of 1000) 1% full

```
rtrv-gtcnv:dir=ittoi:gtixlat=22:tta=23:tti=57:nsdd=3:nsds=800
```

This is an example of the possible output.

```
rlghncxa03w 06-10-28 21:15:37 GMT EAGLE5 36.0.0
DIR  GTIXLAT  TTA  TTI  NP  NAI  DEL  POS  ADD
ittoi  22    23  57  --- ---  3   sfx  800
```

GTCNV table is (15 of 1000) 1% full

```
rtrv-gtcnv:dir=ittoi:gtixlat=24:tta=33:tti=66:np=3:nai=33
```

This is an example of the possible output.

```
rlghncxa03w 06-10-28 21:15:37 GMT EAGLE5 36.0.0
DIR  GTIXLAT  TTA  TTI  NP  NAI  DEL  POS  ADD
ittoi  24    33  66  3   33  --- ---  ---
```

GTCNV table is (15 of 1000) 1% full

```
rtrv-gtcnv:dir=ittoi:gtixlat=24:tta=44:tti=*:np=*:nai=*
```

This is an example of the possible output.

```
rlghncxa03w 06-10-28 21:15:37 GMT EAGLE5 36.0.0
DIR  GTIXLAT  TTA  TTI  NP  NAI  DEL  POS  ADD
itoi   24    44  *   *   *   ---  ---  ---
```

GTCNV table is (15 of 1000) 1% full

```
rtrv-gtcnv:dir=both:gtixlat=22:tta=26:tti=13
```

This is an example of the possible output.

```
rlghncxa03w 06-10-28 21:15:37 GMT EAGLE5 36.0.0
DIR  GTIXLAT  TTA  TTI  NP  NAI  DEL  POS  ADD
both  22    26  13  ---  ---  ---  ---  ---
```

GTCNV table is (15 of 1000) 1% full

```
rtrv-
```

```
gtcnv:dir=both:gtixlat=24:tta=37:tti=59:np=3:nai=33:npdd=3:np
ds=423
```

This is an example of the possible output.

```
rlghncxa03w 06-10-28 21:15:37 GMT EAGLE5 36.0.0
DIR  GTIXLAT  TTA  TTI  NP  NAI  DEL  POS  ADD
both  24    37  59  3  33  3  pfx  423
```

GTCNV table is (15 of 1000) 1% full

5. Backup the new changes using the `chg-db:action=backup:dest=fixed` command. These messages should appear, the active Maintenance and Administration Subsystem Processor (MASP) appears first.

```
BACKUP (FIXED) : MASP A - Backup starts on active MASP.
BACKUP (FIXED) : MASP A - Backup on active MASP to fixed disk
complete.
BACKUP (FIXED) : MASP A - Backup starts on standby MASP.
BACKUP (FIXED) : MASP A - Backup on standby MASP to fixed disk
complete.
```

Figure 2-152 Add a GT Conversion Table Entry - Sheet 1 of 4

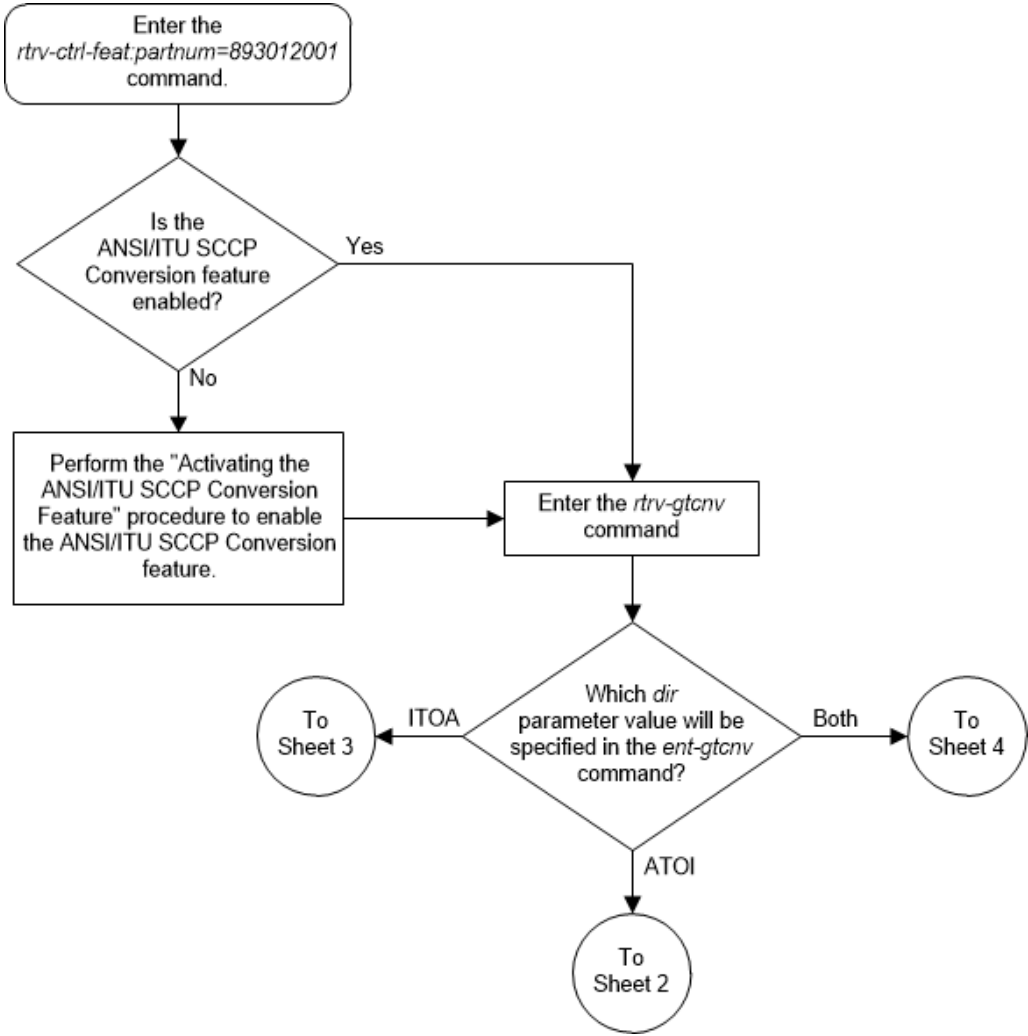

Figure 2-153 Add a GT Conversion Table Entry - Sheet 2 of 4

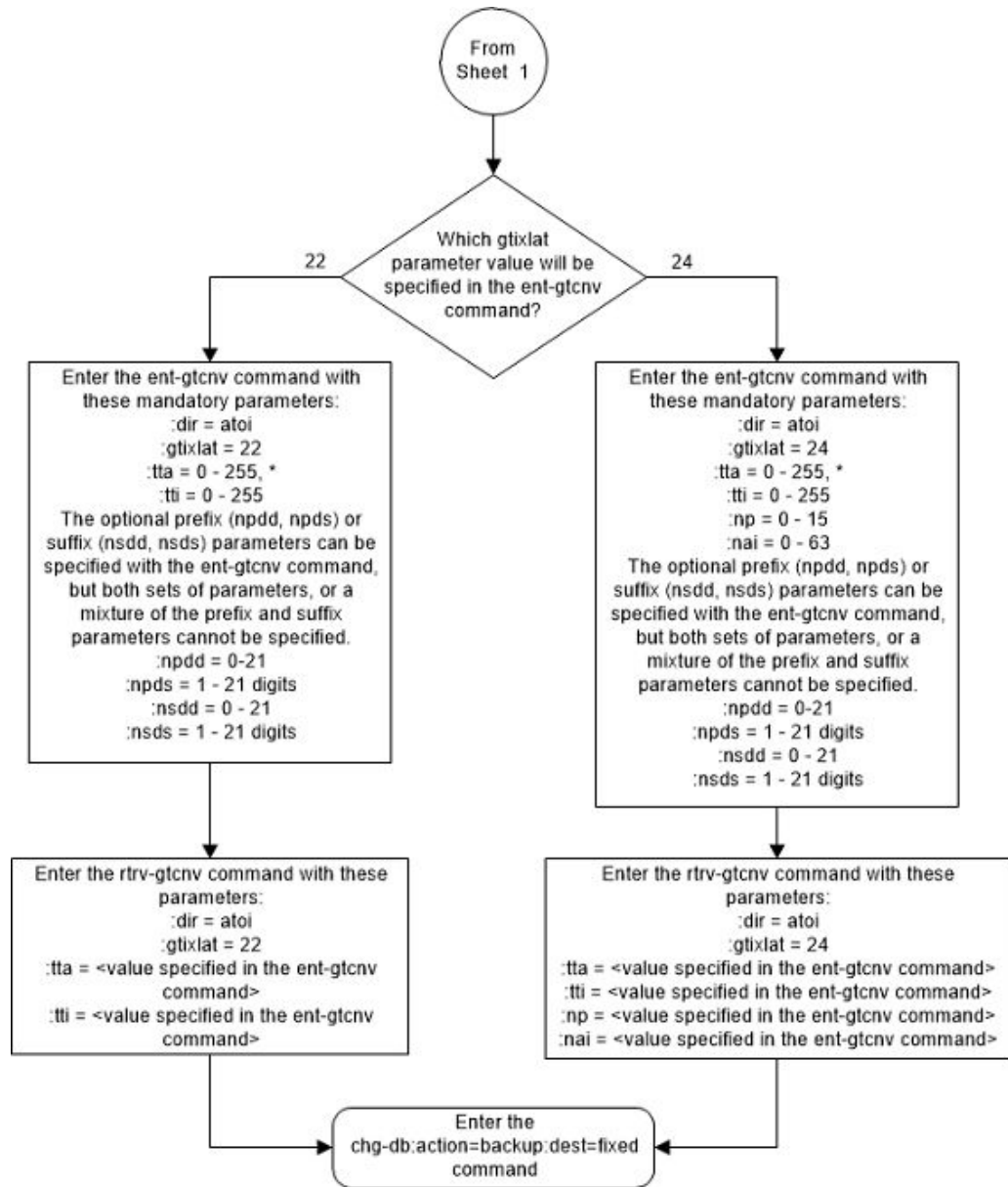

Figure 2-154 Add a GT Conversion Table Entry - Sheet 3 of 4

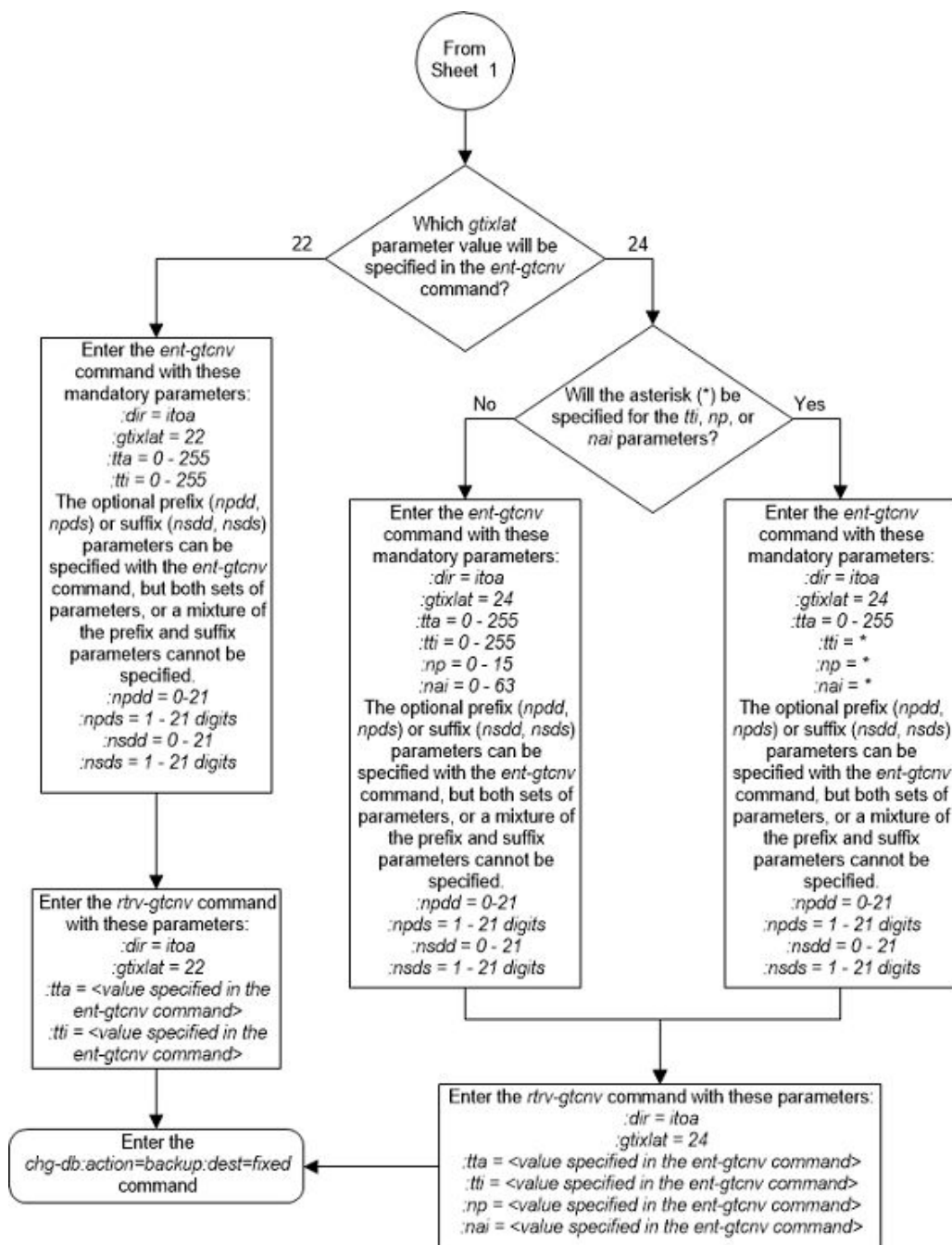
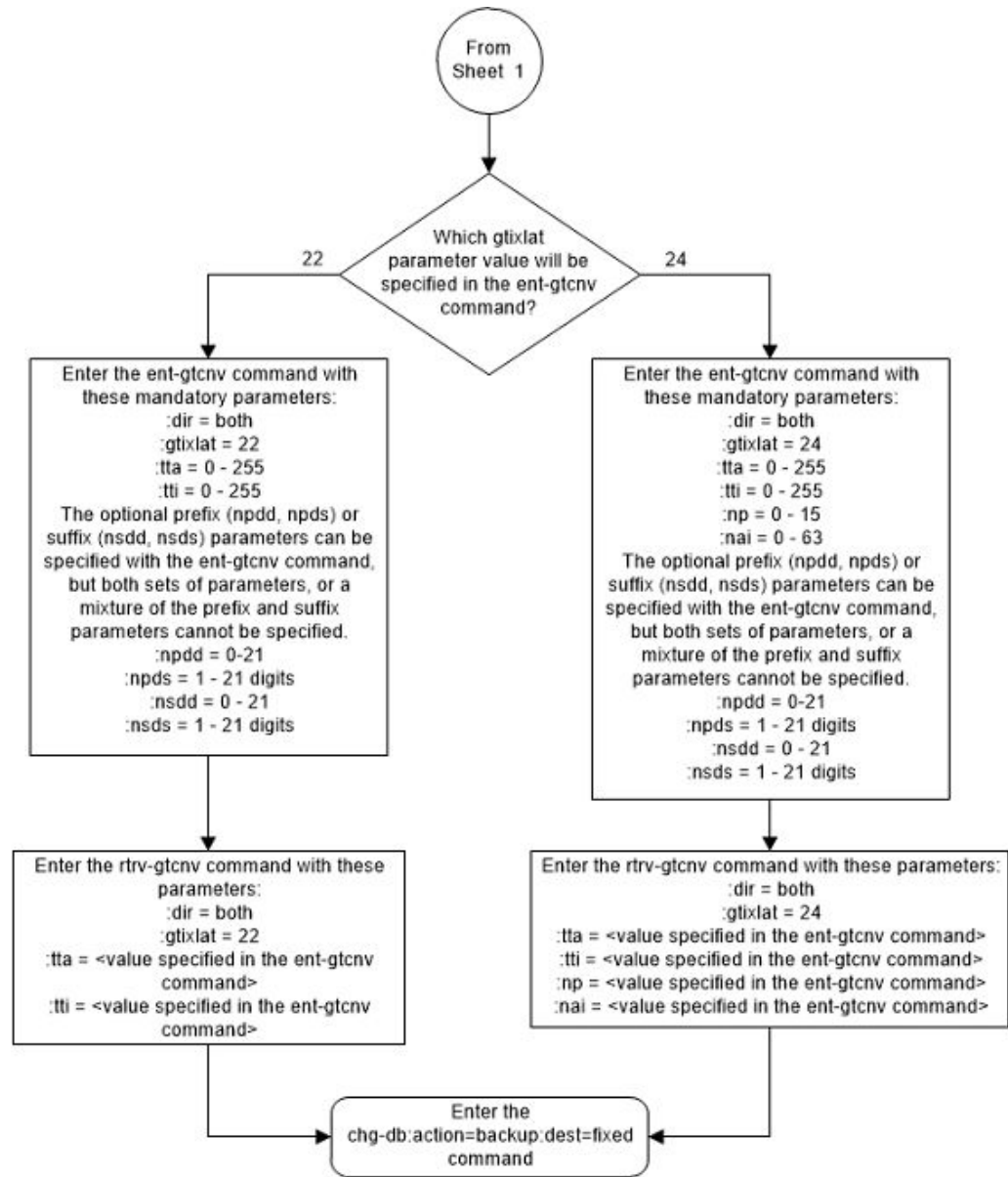

Figure 2-155 Add a GT Conversion Table Entry - Sheet 4 of 4



Removing a GT Conversion Table Entry

This procedure is used to remove an entry from the GT Conversion table using the `dlt-gtcnv` command.

The `dlt-gtcnv` command uses these parameters.

`:dir` – The direction that the conversion takes place

`atoa` – The conversion takes place in the ANSI to ITU direction

`itoa` – The conversion takes place in the ITU to ANSI direction

`both` – The conversion takes place in the ANSI to ITU and ITU to ANSI directions

- :tta – The ANSI translation type
- :tti – The ITU translation type
- :np – The numbering plan
- :nai – The nature of address indicator

To perform this procedure, the ANSI/ITU SCCP Conversion feature must be enabled. Enter the `rtrv-ctrl-feat` command to verify whether or not the ANSI/ITU SCCP Conversion is enabled.



Note:

The ANSI/ITU SCCP Conversion feature can only be permanently enabled.

The `gtixlat` and `dir` parameter values in the GT Conversion Table entry determines how the `tta`, `tti`, `np`, and `nai` parameters are used with the `dlt-gtcnv` command.

- If the `dir` parameter is `atoi`, only the `dir=atoi` and `tta` parameters can be and must be specified with the `dlt-gtcnv` command.
- If the `dir` parameter is `itoa` and the `gtixlat` parameter is 22, only the `dir=itoa` and `tti` parameter can be and must be specified with the `dlt-gtcnv` command.
- If the `dir` parameter is `itoa` and the `gtixlat` parameter is 24, only the `dir=itoa`, `tti`, `np`, and `nai` parameters can be and must be specified for the `dlt-gtcnv` command.
- If the `dir` parameter is `both` and the `gtixlat` parameter is 22, only the `dir=both`, `tta`, and `tti` parameters can be and must be specified with the `dlt-gtcnv` command.
- If the `dir` parameter is `both` and the `gtixlat` parameter is 24, the `dir=both`, `tta`, `tti`, `np`, and `nai` parameters can be and must be specified for the `dlt-gtcnv` command.

The values for the parameters of the GT Conversion Table entry being removed must be entered as shown in the `rtrv-gtcnv` output.

The GT Conversion Table entry specified in the `dlt-gtcnv` command must be shown in the `rtrv-gtcnv` output.

1. Display the GT Conversion Table entries by entering the `rtrv-gtcnv` command.

The following is an example of the possible output.

```
rlghncxa03w 07-05-28 21:15:37 GMT EAGLE5 37.0.0
DIR  GTIXLAT  TTA  TTI  NP  NAI  DEL  POS  ADD
atoi  24      *   29  4   87  ---  ---  ---
atoi  22      10  43  --- ---  3   pfx  919
itoi   22      23  57  --- ---  3   sfx  800
atoi  22      24  12  --- ---  ---  ---  ---
both   22      26  13  --- ---  ---  ---  ---
itoa   22      2   5   --- ---  ---  ---  ---
itoi   24      33  66  3   33  ---  ---  ---
```

```

both    24    37    59    3    33    3    pfx  423
ittoa   24    3     6     4     8    ---  ---  ---
ittoi   24   44    *     *     *    ---  ---  ---
ittoa   24    4     7     4     8     3    sfx  123
atoi   24    5     7     4     8     3    sfx  123
atoi   22    7     8    ---  ---  3    sfx  123
both    24    8     9     4     8     4    pfx  4567
both    22    9     11   ---  ---  ---  ---  ---
GTCNV table is (8 of 1000) 1% full

```

If no entries are shown in the `rtrv-gtcnv` output, this procedure cannot be performed.

If error message E4171 (E4171 Cmd Rej: SCCP Conversion feature must be enabled) is displayed after the `rtrv-gtcnv` command is entered, the ANSI/ITU SCCP Conversion feature is not enabled. If the ANSI/ITU SCCP Conversion feature has not been enabled, this procedure cannot be performed. If error message E4171 (E4171 Cmd Rej: SCCP Conversion feature must be enabled) is not displayed after the `rtrv-gtcnv` command is entered and entries are shown in the `rtrv-gtcnv` output, continue the procedure with 2.

2. Remove the desired GT Conversion Table entry by entering the `dlt-gtcnv` command with the appropriate parameter combinations shown in the following list and with the values for these parameters shown in the `rtrv-gtcnv` output in 1.
 - a. `dir=atoi, tta`
 - b. `dir=ittoa, gtixlat=22, tti`
 - c. `dir=ittoa, gtixlat=24, tti, np, nai`
 - d. `dir=both, gtixlat=22, tta, tti`
 - e. `dir=both, gtixlat=24, tta, tti, np, nai`

 **Note:**

The `gtixlat` parameter cannot be specified with the `dlt-gtcnv` command, but is used to determine the parameter combinations that must be specified with the `dlt-gtcnv` command.

For this example, enter these commands.

```

dlt-gtcnv:dir=atoi:tta=10
dlt-gtcnv:dir=ittoi:tta=33:tti=66:np=3:nai=33
dlt-gtcnv:dir=ittoi:tta=44:tti=*:np=*:nai=*
dlt-gtcnv:dir=both:tta=26:tti=13

```

When each of these commands have successfully completed, the following message should appear.

```

rlghncxa03w 07-05-28 21:15:37 GMT EAGLE5 37.0.0
DLT-GTCNV: MASP A - COMPLTD

```

3. Verify the changes using the `rtrv-gtcnv` command and specifying the parameter values used in 2, along with the `gtixlat` parameter value shown in the `rtrv-gtcnv` output in 1 that was assigned to the GT Conversion Table entry removed in 2.

For this example, enter these commands.

```
rtrv-gtcnv:dir=atoi:gtixlat=22:tta=10:tti=43
```

This is an example of the possible output.

```
rlghncxa03w 07-05-28 21:15:37 GMT EAGLE5 37.0.0
DIR  GTIXLAT  TTA  TTI  NP  NAI  DEL  POS  ADD
atoi   22    10   43   --- ---  3    pfx  919
GTCNV table is (11 of 1000) 1% full
```

```
rtrv-gtcnv:dir=ittoi:gtixlat=24:tta=33:tti=66:np=3:nai=33
```

This is an example of the possible output.

```
rlghncxa03w 07-05-28 21:15:37 GMT EAGLE5 37.0.0
DIR  GTIXLAT  TTA  TTI  NP  NAI  DEL  POS  ADD
ittoi   24    33   66   3   33   --- ---  ---
GTCNV table is (11 of 1000) 1% full
```

```
rtrv-gtcnv:dir=ittoi:gtixlat=24:tta=44:tti=*:np=*:nai=*
```

This is an example of the possible output.

```
rlghncxa03w 07-05-28 21:15:37 GMT EAGLE5 37.0.0
DIR  GTIXLAT  TTA  TTI  NP  NAI  DEL  POS  ADD
ittoi   24    44   *   *   *   --- ---  ---
GTCNV table is (11 of 1000) 1% full
```

```
rtrv-gtcnv:dir=both:gtixlat=22:tta=26:tti=13
```

This is an example of the possible output.

```
rlghncxa03w 07-05-28 21:15:37 GMT EAGLE5 37.0.0
DIR  GTIXLAT  TTA  TTI  NP  NAI  DEL  POS  ADD
both   22    26   13   --- ---  --- ---  ---
GTCNV table is (11 of 1000) 1% full
```

4. Backup the new changes using the `chg-db:action=backup:dest=fixed` command.

These messages should appear, the active Maintenance and Administration Subsystem Processor (MASP) appears first.

```
BACKUP (FIXED) : MASP A - Backup starts on active MASP.
BACKUP (FIXED) : MASP A - Backup on active MASP to fixed disk
complete.
BACKUP (FIXED) : MASP A - Backup starts on standby MASP.
BACKUP (FIXED) : MASP A - Backup on standby MASP to fixed disk
complete.
```

Figure 2-156 Remove a GT Conversion Table Entry - Sheet 1 of 4

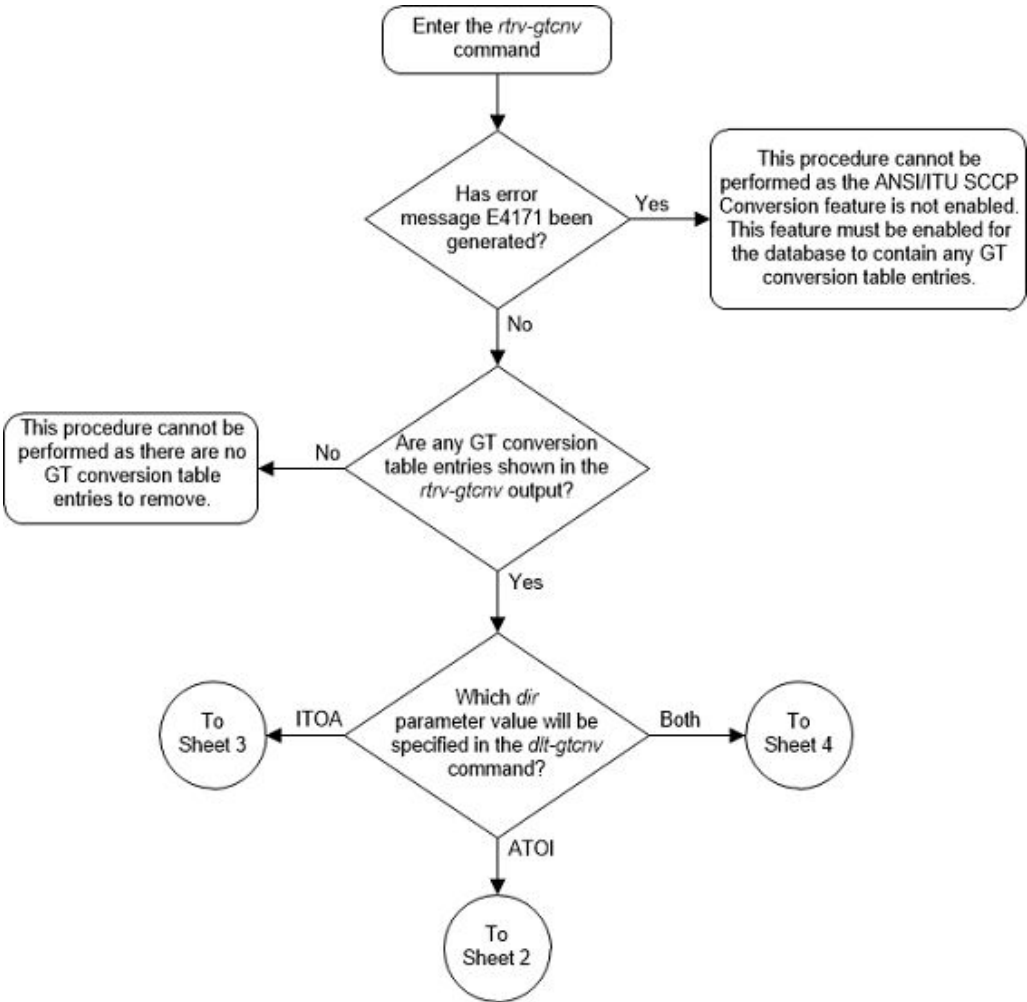

Figure 2-157 Remove a GT Conversion Table Entry - Sheet 2 of 4

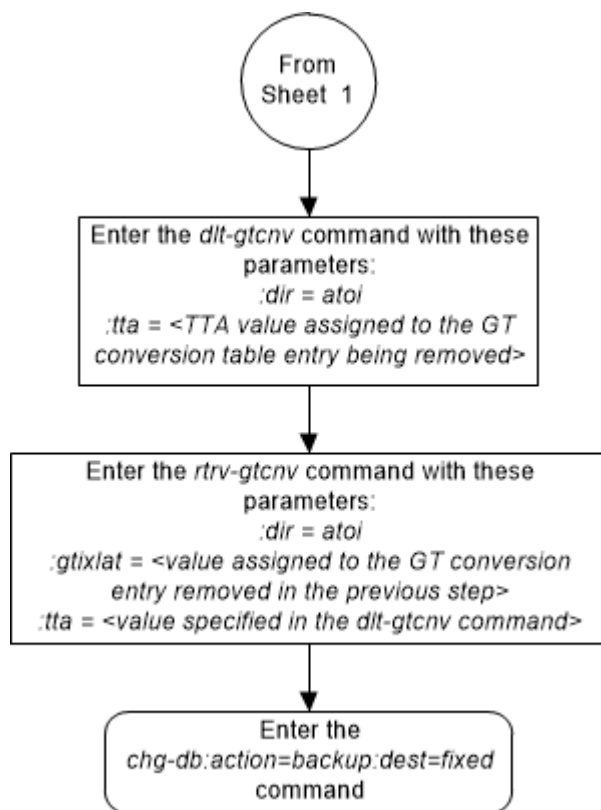

Figure 2-158 Remove a GT Conversion Table Entry - Sheet 3 of 4

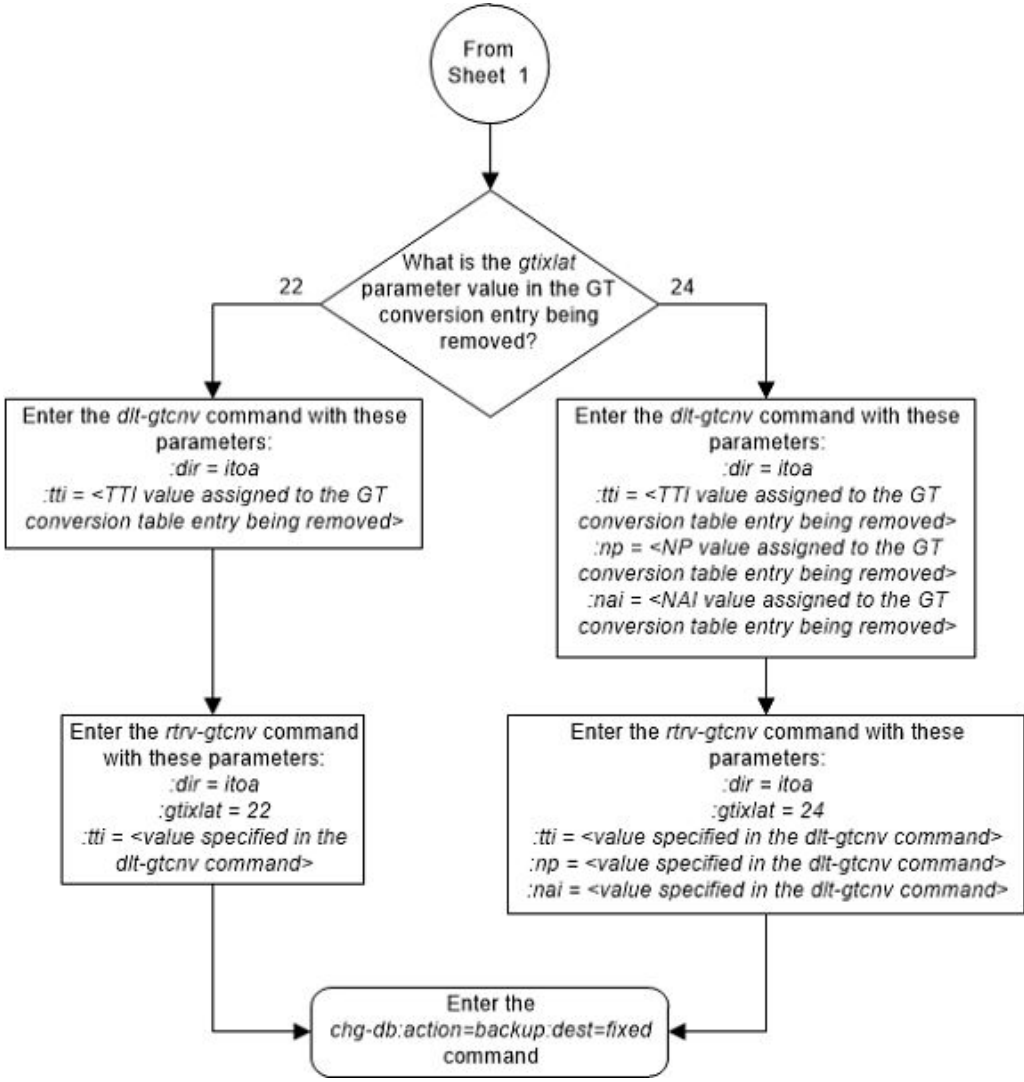
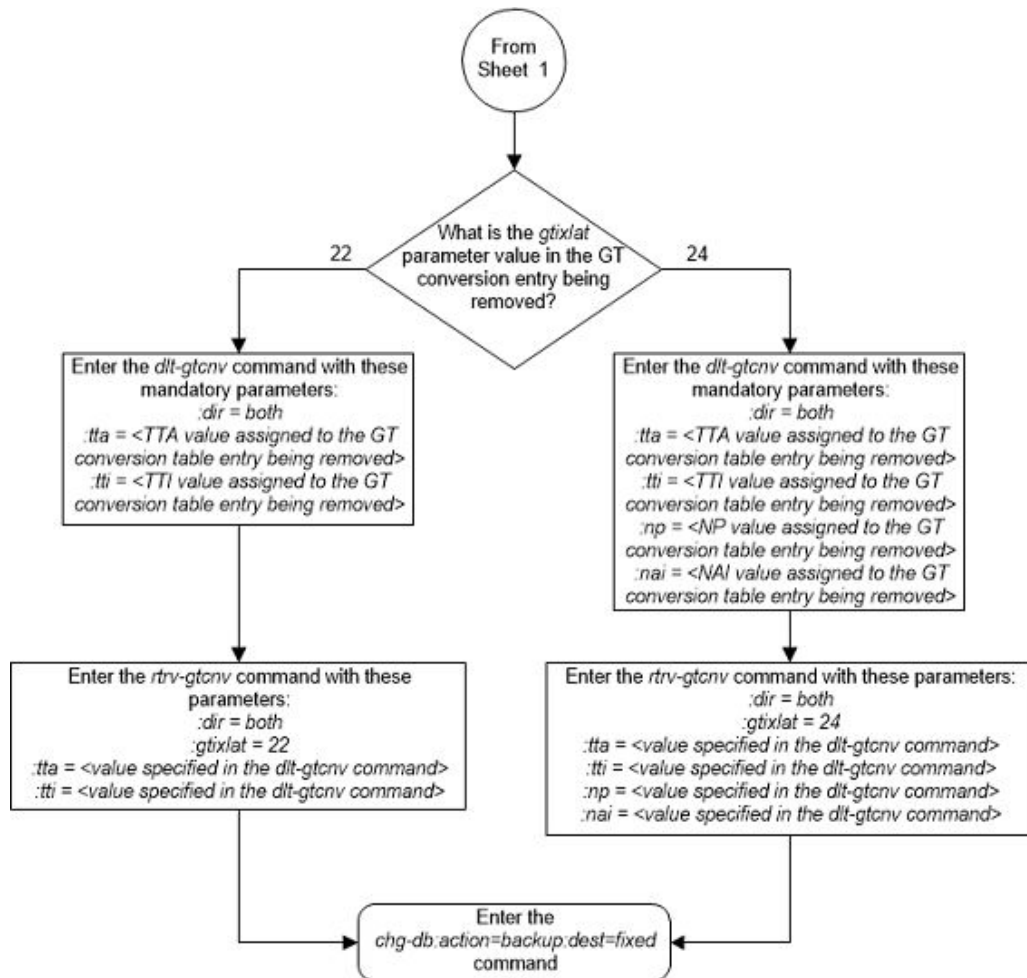

Figure 2-159 Remove a GT Conversion Table Entry - Sheet 4 of 4



Changing a GT Conversion Table Entry

This procedure is used to provision an entry in the GT Conversion table for the ANSI/ITU SCCP Conversion feature using the `chg-gtcnv` command.

The `chg-gtcnv` command uses these parameters.

- `:dir` – The direction that the conversion takes place
- `atoa` – The conversion takes place in the ANSI to ITU direction
- `itoa` – The conversion takes place in the ITU to ANSI direction
- `both` – The conversion takes place in the ANSI to ITU and ITU to ANSI directions
- `:tta` – The ANSI translation type
- `:tti` – The ITU translation type
- `:np` – The numbering plan
- `:nai` – The nature of address indicator

:npdd – The number of digits to be deleted or substituted from the beginning of the Global Title Address digits (the prefix digits)

:npds – The digits that are being substituted for the prefix digits

:nsdd – The number of digits to be deleted or substituted from the end of the Global Title Address digits (the suffix digits)

:nsds – The digits that are being substituted for the suffix digits

:rdmod – This parameter specifies whether or not the existing npdd, npds, nsdd, nsds parameter values are removed from the GT Conversion Table entry. If the value of this parameter is `yes`, the existing npdd, npds, nsdd, nsds parameter values are removed from the GT Conversion Table entry. If the value of this parameter is `no`, the default value, the existing npdd, npds, nsdd, nsds parameter values are not removed from the GT Conversion Table entry.

To perform this procedure, the ANSI/ITU SCCP Conversion feature must be enabled. Enter the `rtrv-ctrl-feat` command to verify whether or not the ANSI/ITU SCCP Conversion is enabled.

 **Note:**

The ANSI/ITU SCCP Conversion feature can only be permanently enabled.

The `gtixlat` and `dir` parameter values in the GT Conversion Table entry determines how the `tta`, `ttd`, `np`, `nai`, `npdd`, `npds`, `nsdd`, `nsds`, and `rdmod` parameters are used with the `chg-gtcnv` command.

- If the `dir` parameter is `atoi`, the `dir=atoi` and `tta` parameters must be specified with the `chg-gtcnv` command. If the `gtixlat` parameter is 22, the optional parameters `ttd`, `npdd`, `npds`, `nsdd`, `nsds`, and `rdmod` can be specified with the `chg-gtcnv` command. If the `gtixlat` parameter is 24, the optional parameters `ttd`, `np`, `nai`, `npdd`, `npds`, `nsdd`, `nsds`, and `rdmod` can be specified with the `chg-gtcnv` command.
- If the `dir` parameter is `itda` and the `gtixlat` parameter is 22, the `dir=itda` and `ttd` parameters must be specified with the `chg-gtcnv` command. The optional parameters `tta`, `npdd`, `npds`, `nsdd`, `nsds`, and `rdmod` can be specified with the `chg-gtcnv` command.
- If the `dir` parameter is `itda` and the `gtixlat` parameter is 24, the `dir=itda` and `ttd`, `np`, and `nai` parameters must be specified with the `chg-gtcnv` command. The optional parameters `tta`, `npdd`, `npds`, `nsdd`, `nsds`, and `rdmod` can be specified with the `chg-gtcnv` command.
- If the `dir` parameter is `both` and the `gtixlat` parameter is 22, the `dir=both`, `tta`, and `ttd` parameters must be specified with the `chg-gtcnv` command. The optional parameters `npdd`, `npds`, `nsdd`, `nsds`, and `rdmod` can be specified with the `chg-gtcnv` command.
- If the `dir` parameter is `both` and the `gtixlat` parameter is 24, the `dir=both`, `tta`, `ttd`, `np`, and `nai` parameters must be specified with the `chg-gtcnv` command. The optional parameters `npdd`, `npds`, `nsdd`, `nsds`, and `rdmod` can be specified with the `chg-gtcnv` command.

If the `rdmod=yes` parameter is specified with the `chg-gtcnv` command, the `npdd`, `npds`, `nsdd`, and `nsds` parameters cannot be specified.

If the `npdd`, `npds`, `nsdd`, or `nsds` parameters are specified with the `chg-gtcnv` command, the `rdmod=yes` parameter cannot be specified.

The optional prefix (`npdd`, `npds`) and suffix parameters (`nsdd`, `nsds`) can be specified, but both sets of parameters, or a mixture of the prefix and suffix parameters cannot be specified. For example, if either the `npdd` or `npds` parameters are specified, the `nsdd` and `nsds` cannot be specified. If either the `nsdd` or `nsds` parameters are specified, the `npdd` and `npds` parameters cannot be specified.

The prefix or suffix parameter values assigned to a GT Conversion Table entry can be changed from one type to another type, (prefix parameter values to suffix parameter values or suffix parameter values to prefix parameter values). To change the prefix values to suffix values or suffix values to prefix values, the existing prefix or suffix values must be removed from the GT Conversion Table entry by specifying the `rdmod=yes` with the `chg-gtcnv` command. After the existing prefix or suffix values have been removed, the new prefix or suffix values can be assigned to the GT Conversion Table entry with the `npdd` and `npds`, or `nsdd` and `nsds` parameters.

The values for the mandatory parameters of the GT Conversion Table entry being changed must be entered as shown in the `rtrv-gtcnv` output.

The GT Conversion Table entry specified in the `chg-gtcnv` command must be shown in the `rtrv-gtcnv` output.

1. Verify the status of the ANSI/ITU SCCP Conversion feature by entering the `rtrv-ctrl-feat` command with the ANSI/ITU SCCP Conversion feature part number.

Enter this command.

```
rtrv-ctrl-feat:partnum=893012001
```

The following is an example of the possible output.

```
rlghncxa03w 06-10-28 21:15:37 GMT EAGLE5 36.0.0
```

The following features have been permanently enabled:

Feature Name	Partnum	Status	Quantity
SCCP Conversion	893012010	on	----

The following features have been temporarily enabled:

Feature Name	Partnum	Status	Quantity	Trial
Period Left				

Zero entries found.

The following features have expired temporary keys:

Feature Name	Partnum
Zero entries found.	

If the ANSI/ITU SCCP Conversion feature has not been enabled or is not on, this procedure cannot be performed.

2. Display the GT Conversion Table entries by entering the `rtrv-gtcnv` command.

The following is an example of the possible output.

```
rlghncxa03w 06-10-28 21:15:37 GMT EAGLE5 36.0.0
DIR  GTIXLAT  TTA  TTI  NP  NAI  DEL  POS  ADD
atoi  24      *   29  4   87  ---  ---  ---
atoi  22      10  43  --- ---  3   pfx  919
ittoi  22      23  57  --- ---  3   sfx  800
atoi  22      24  12  --- ---  ---  ---  ---
both  22      26  13  --- ---  ---  ---  ---
ittoa  22      2   5   --- ---  ---  ---  ---
ittoi  24      33  66  3   33  ---  ---  ---
both  24      37  59  3   33  3   pfx  423
ittoa  24      3   6   4   8   ---  ---  ---
ittoi  24      44  *   *   *   ---  ---  ---
ittoa  24      4   7   4   8   3   sfx  123
atoi  24      5   7   4   8   3   sfx  123
atoi  22      7   8   --- ---  3   sfx  123
both  24      8   9   4   8   4   pfx  4567
both  22      9   11  --- ---  ---  ---  ---
```

GTCNV table is (15 of 1000) 1% full

If no entries are shown in the `rtrv-gtcnv` output, this procedure cannot be performed.

 **Note:**

If prefix or suffix digits are not assigned to the GT Conversion Table entry being changed, not being removed, or not being changed from one type to another (prefix digits changed to suffix digits or suffix digits changed to prefix digits), continue the procedure with 5.

3. Change the desired GT Conversion Table entry by entering the `chg-gtcnv` command with the `rdmod=yes` parameter, and with appropriate parameter combinations shown in the following list and with the values for these parameters shown in the `rtrv-gtcnv` output in 2.

- `dir=atoi, tta.`

If the `gtixlat` parameter value is 22, the optional parameter `tti=<0-255>` can be specified with the `chg-gtcnv` command. If the `gtixlat` parameter value is 24, the optional parameters `tti=<0-255>`, `np=<0-15>`, `nai=<0-63>`, can be specified with the `chg-gtcnv` command.

- `dir=ittoa, gtixlat=22, tti.`

The optional parameter `tta=<0-255>` can be specified with the `chg-gtcnv` command.

- `dir=ittoa, gtixlat=24, tti, np, nai.`

The optional parameter `tta=<0-255>` can be specified with the `chg-gtcnv` command.

- `dir=both, gtixlat=22, tta, tti`

- `dir=both, gtixlat=24, tta, tti, np, nai`

 **Note:**

The `gtixlat` parameter cannot be specified with the `chg-gtcnv` command, but is used to determine the parameter combinations that must be specified with the `chg-gtcnv` command.

For this example, enter these commands.

```
chg-gtcnv:dir=atoi:tta=10:rdmod=yes
chg-gtcnv:dir=ittoi:tti=7:np=4:nai=8:rdmod=yes
chg-gtcnv:dir=both:tta=37:tti=59:np=3:nai=33:rdmod=yes
```

When each of these commands have successfully completed, the following message should appear.

```
rlghncxa03w 06-10-28 21:15:37 GMT EAGLE5 36.0.0
CHG-GTCNV: MASP A - COMPLTD
```

4. Verify the changes using the `rtrv-gtcnv` command and specifying the parameter values used in 3, along with the `gtixlat` parameter value shown in the `rtrv-gtcnv` output in 2 that was assigned to the GT Conversion Table entry changed in 3.

For this example, enter these commands.

```
rtrv-gtcnv:dir=atoi:gtixlat=22:tta=10
```

This is an example of the possible output.

```
rlghncxa03w 06-10-28 21:15:37 GMT EAGLE5 36.0.0
DIR  GTIXLAT  TTA  TTI  NP  NAI  DEL  POS  ADD
atoi   22    10  43  --- --- --- --- ---
```

GTCNV table is (11 of 1000) 1% full

```
rtrv-gtcnv:dir=ittoi:gtixlat=24:tti=7
```

This is an example of the possible output.

```
rlghncxa03w 06-10-28 21:15:37 GMT EAGLE5 36.0.0
DIR  GTIXLAT  TTA  TTI  NP  NAI  DEL  POS  ADD
ittoa  24    4   7   4   8   --- --- ---
```

GTCNV table is (11 of 1000) 1% full

```
rtrv-gtcnv:dir=both:gtixlat=24:tta=37:tti=59
```

This is an example of the possible output.

```
rlghncxa03w 06-10-28 21:15:37 GMT EAGLE5 36.0.0
DIR  GTIXLAT  TTA  TTI  NP  NAI  DEL  POS  ADD
both  24    37  59  3  33  --- --- ---
GTCNV table is (11 of 1000) 1% full
```

- Change the desired GT Conversion Table entry by entering the `chg-gtcnv` command with appropriate parameter combinations shown in [Table 2-19](#) and with the values for these parameters shown in the `rtrv-gtcnv` output in [2](#).

 **Note:**

If [3](#) and [4](#) were performed, and no other changes are being made to the GT Conversion entry, do not perform this step. Continue the procedure with [7](#).

Table 2-59 GT Conversion Parameter Combinations

GTIXLAT=22 DIR = ATOI	GTIXLAT=22 DIR = ITOA	GTIXLAT=22 DIR = BOTH	GTIXLAT=24 DIR = ATOI	GTIXLAT=24 DIR = ITOA	GTIXLAT=24 DIR = BOTH
TTA = <current TTA value>	TTI = <current TTI value>	TTA = <current TTA value> TTI = <current TTI value>	TTA = <current TTA value>	TTI = <current TTI value> NP = <current NP value> NAI = <current NAI value>	TTA = <current TTA value> TTI = <current TTI value> NP = <current NP value> NAI = <current NAI value>
Optional Parameters					
TTI = 0-255	TTA = 0-255	NPDD = 0-21	TTI = 0-255	TTA = 0-255	NPDD = 0-21
NPDD = 0-21	NP = 0-15	NPDS = 1 - 21 digits	NP = 0-15	NPDD = 0-21	NPDS = 1 - 21 digits
NPDS = 1 - 21 digits	NAI = 0-63	NSDD = 0-21	NPDD = 0-21	NPDS = 1 - 21 digits	NSDD = 0-21
NSDD = 0-21	NPDS = 1 - 21 digits	NSDS = 1 - 21 digits	NPDS = 1 - 21 digits	NSDD = 0-21	NSDS = 1 - 21 digits
NSDS = 1 - 21 digits	NSDD = 0-21		NSDD = 0-21	NSDS = 1 - 21 digits	
	NSDS = 1 - 21 digits		NSDS = 1 - 21 digits		

Notes:

- The `gtixlat` parameter cannot be specified with the `chg-gtcnv` command, but is used to determine the parameter combinations that can be specified with the `chg-gtcnv` command.
- If the GT Conversion Table entry contains no prefix (`npdd`, `npds`) or suffix (`nsdd`, `nsds`) parameter values, the prefix or suffix parameters can be specified with the `chg-gtcnv` command, but both sets of parameters, or a mixture of the prefix or suffix parameters cannot be specified.
- If the GT Conversion Table entry contains prefix parameter values, the suffix parameters cannot be specified with the `chg-gtcnv` command.
- If the GT Conversion Table entry contains suffix parameter values, the prefix parameters cannot be specified with the `chg-gtcnv` command.

For this example, enter these commands.

```
chg-gtcnv:dir=atoi:tta=10:tti=35:nsdd=3:nsds=818
chg-gtcnv:dir=ittoi:tti=7:np=4:nai=8:tta=40:npdd=3:npds=202
chg-gtcnv:dir=both:tta=8:tti=9:np=4:nai=8:npds=6151
```

When each of these commands have successfully completed, the following message should appear.

```
rlghncxa03w 06-10-28 21:15:37 GMT EAGLE5 36.0.0
CHG-GTCNV: MASP A - COMPLTD
```

- Verify the changes using the `rtrv-gtcnv` command and specifying the parameter values used in 5, along with the `gtixlat` parameter value shown in the `rtrv-gtcnv` output in 2 that was assigned to the GT Conversion Table entry changed in 5.

For this example, enter these commands.

```
rtrv-gtcnv:dir=atoi:gtixlat=22:tta=10
```

This is an example of the possible output.

```
rlghncxa03w 06-10-28 21:15:37 GMT EAGLE5 36.0.0
DIR  GTIXLAT  TTA  TTI  NP  NAI  DEL  POS  ADD
atoi   22    10   25   --- ---   3    sfx  818
```

GTCNV table is (11 of 1000) 1% full

```
rtrv-gtcnv:dir=ittoi:gtixlat=24:tti=7
```

This is an example of the possible output.

```
rlghncxa03w 06-10-28 21:15:37 GMT EAGLE5 36.0.0
DIR  GTIXLAT  TTA  TTI  NP  NAI  DEL  POS  ADD
itoa   24    40   7    4   8    3    pfx  202
```

GTCNV table is (11 of 1000) 1% full

```
rtrv-gtcnv:dir=both:gtixlat=24:tta=8:tti=9
```

This is an example of the possible output.

```
rlghncxa03w 06-10-28 21:15:37 GMT EAGLE5 36.0.0
DIR  GTIXLAT  TTA  TTI  NP  NAI  DEL  POS  ADD
both   24     8   9    4   8    4    pfx  6151
```

GTCNV table is (11 of 1000) 1% full

- Backup the new changes using the `chg-db:action=backup:dest=fixed` command.

These messages should appear, the active Maintenance and Administration Subsystem Processor (MASP) appears first.

```
BACKUP (FIXED) : MASP A - Backup starts on active MASP.
BACKUP (FIXED) : MASP A - Backup on active MASP to fixed disk
```

complete.
BACKUP (FIXED) : MASP A - Backup starts on standby MASP.
BACKUP (FIXED) : MASP A - Backup on standby MASP to fixed disk
complete.

Figure 2-160 Change a GT Conversion Table Entry - Sheet 1 of 7

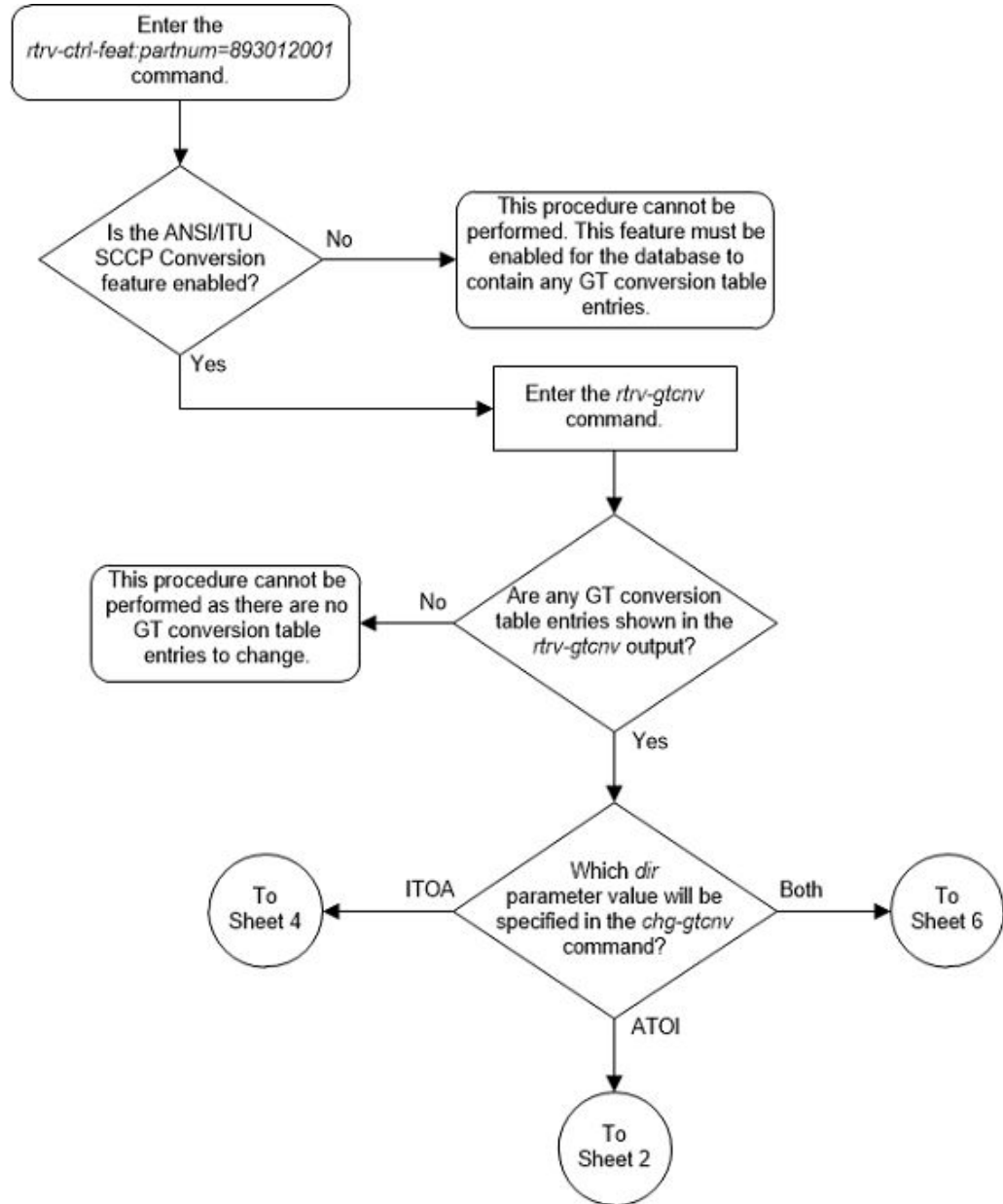

Figure 2-161 Change a GT Conversion Table Entry - Sheet 2 of 7

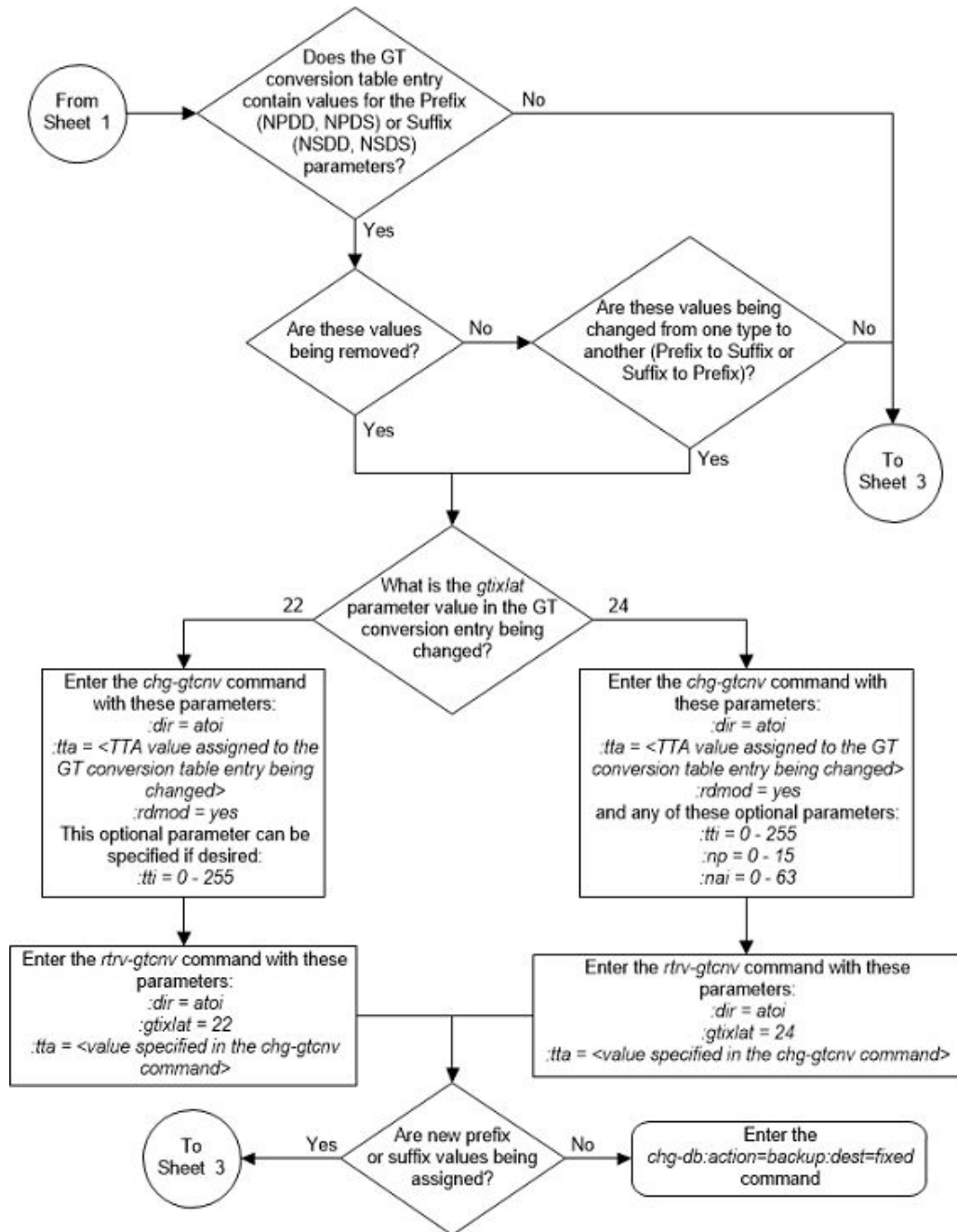

Figure 2-162 Change a GT Conversion Table Entry - Sheet 3 of 7

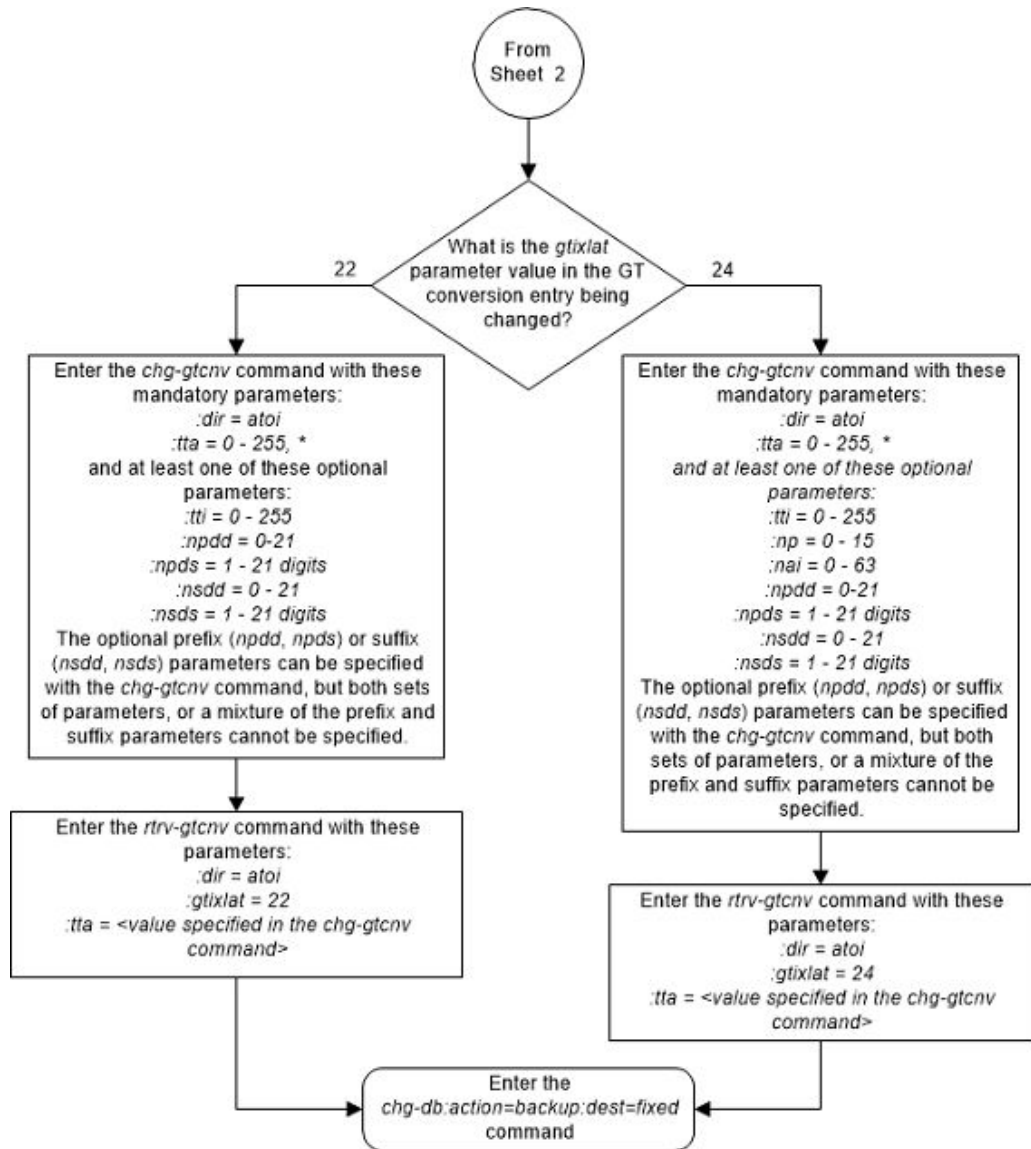

Figure 2-163 Change a GT Conversion Table Entry - Sheet 4 of 7

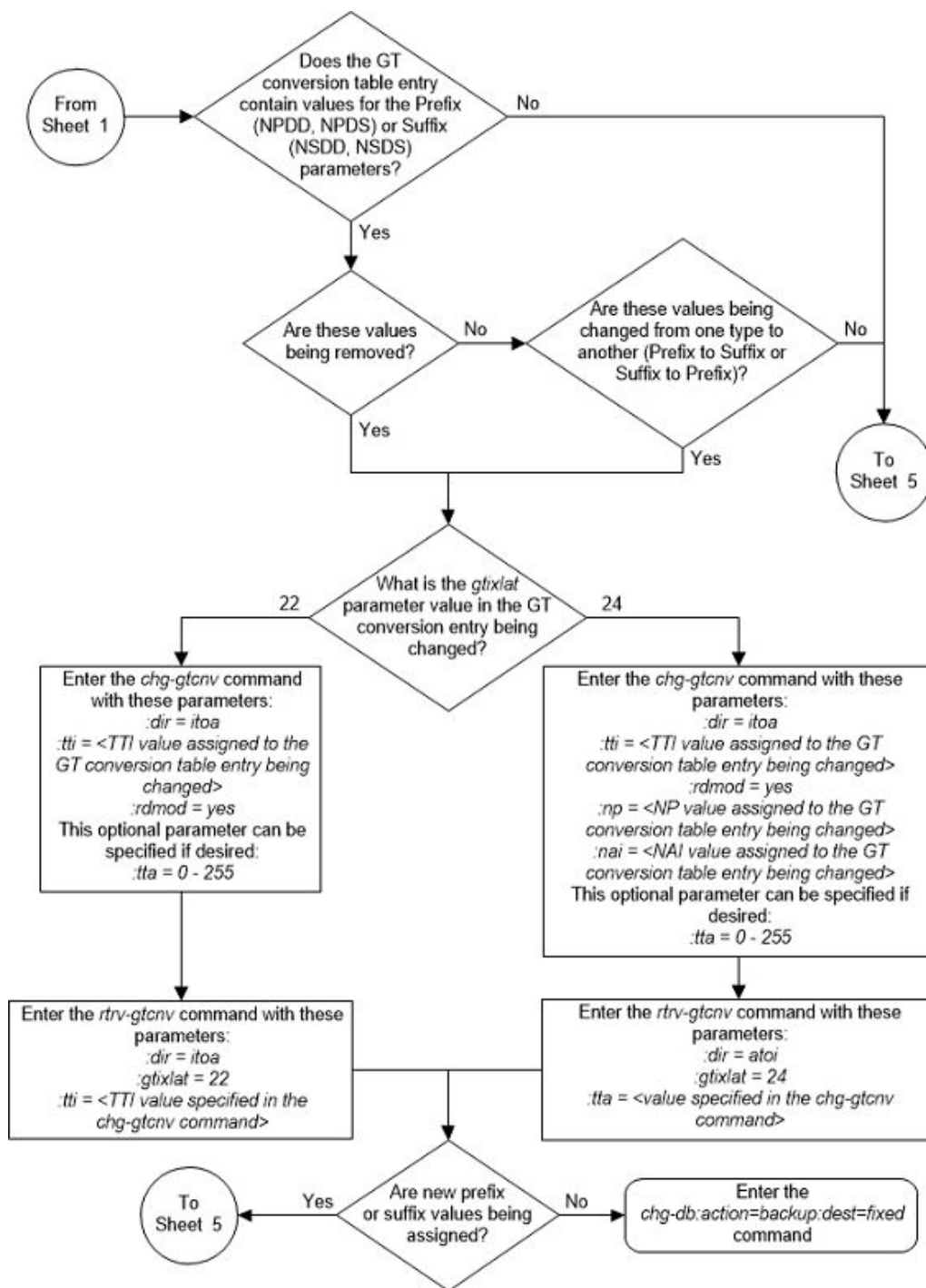

Figure 2-164 Change a GT Conversion Table Entry - Sheet 5 of 7

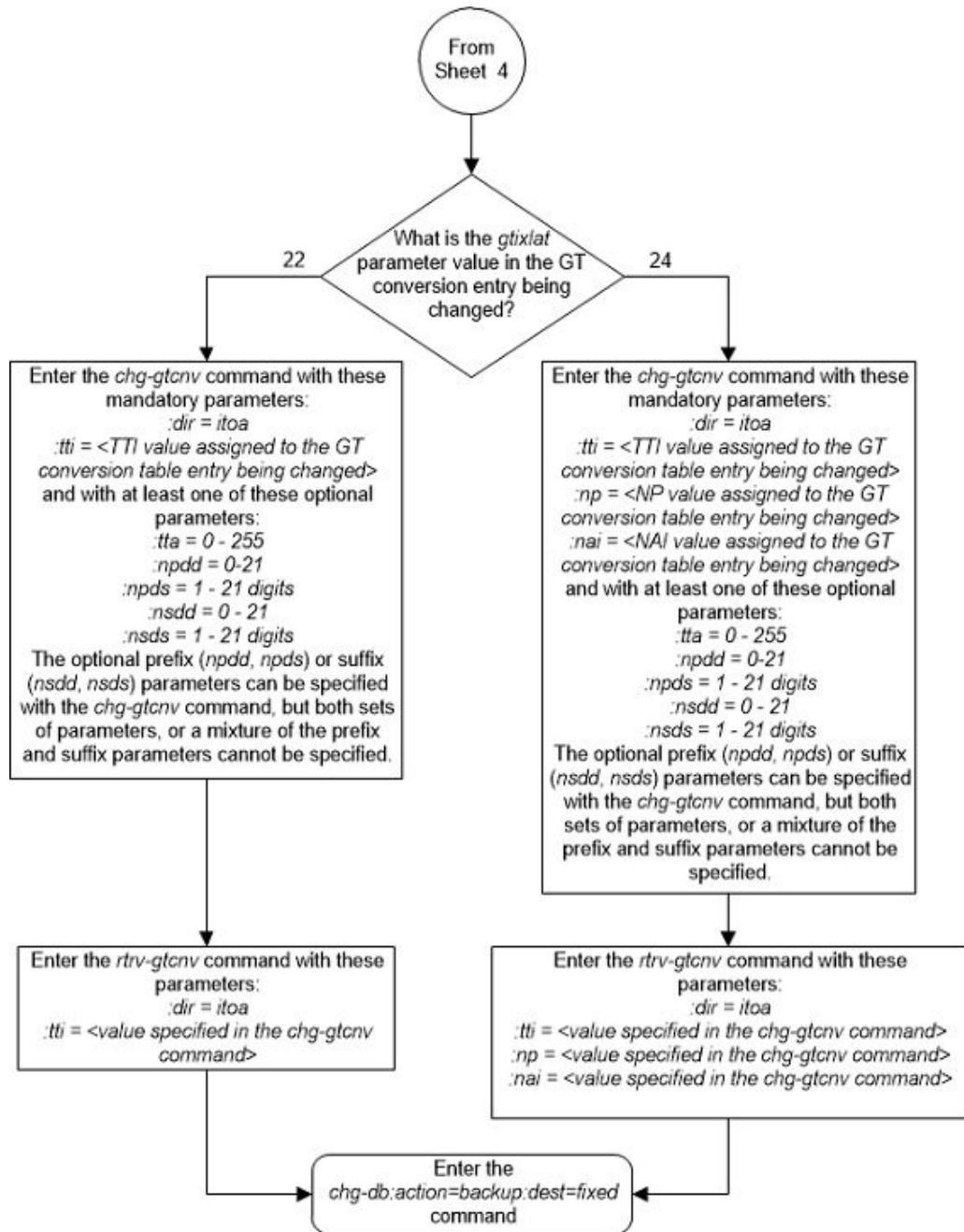

Figure 2-165 Change a GT Conversion Table Entry - Sheet 6 of 7

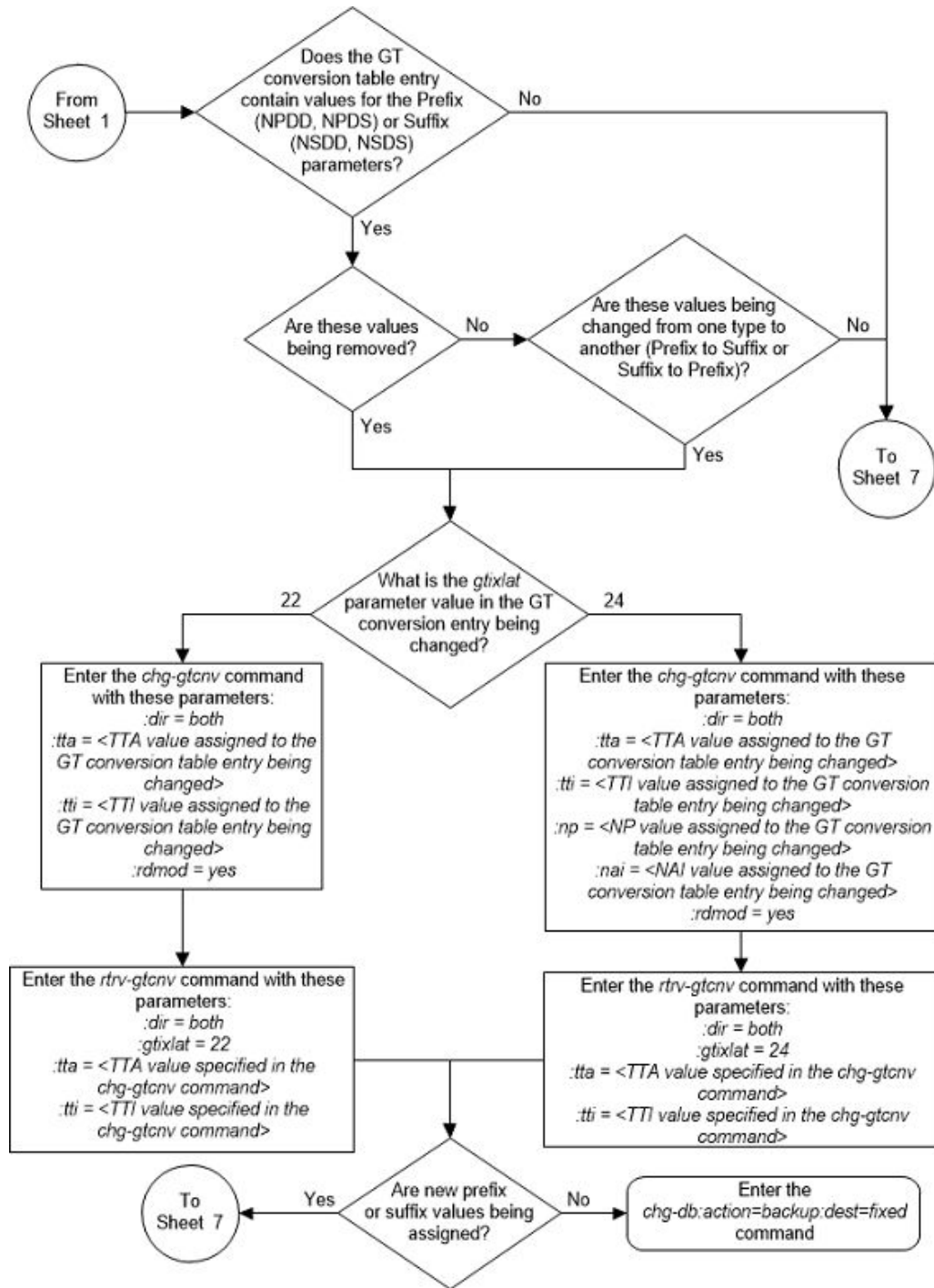
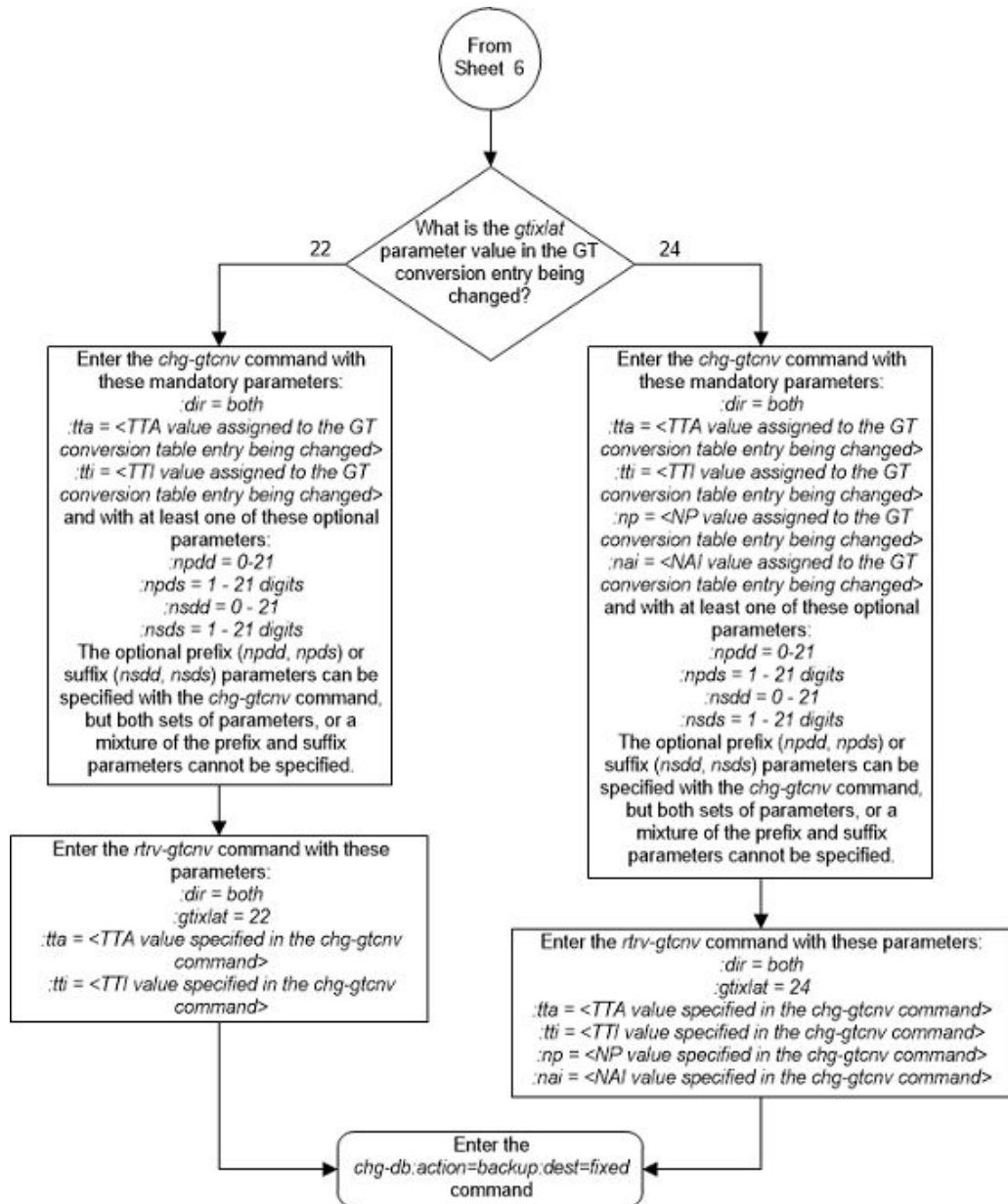

Figure 2-166 Change a GT Conversion Table Entry - Sheet 7 of 7



Changing the ANSI/ITU SCCC Conversion Options

This procedure is used to change the options used for the ANSI/ITU SCCC Conversion feature using the `chg-stpopts` command. The options are:

:cnvcgda – The CGPA point code in ANSI SCCC messages are discarded if the point code or alias point code of the destination network type is not defined.

:cnvcgdi – The CGPA point code in ITU-I SCCC messages are discarded if the point code or alias point code of the destination network type is not defined.

:cnvcgdn – The CGPA point code in ITU-N SCCP messages are discarded if the point code or alias point code of the destination network type is not defined.

:cnvcgdn24 – The CGPA point code in ITU-N24 SCCP messages are discarded if the point code or alias point code of the destination network type is not defined.

:cnvclgitu – Enables or disables ITU-X to ITU-Y SCCP CGPA Conversion.

:gtcnvdfilt – SCCP messages are routed using system defaults when an appropriate entry is not found in the Default GT Conversion Table.

The values for each of these parameters, shown in the `rtrv-stpopts` output, is either `yes` or `no`. The system default values for these parameters is `no`.

These parameters of the `chg-stpopts` command are optional. For any parameters not specified with the `chg-stpopts` command, the values for these parameters are not changed.

The current values for these parameters are shown in the `CNVCGDA`, `CNVCGDI`, `CNVCGDN`, `CNVCGDN24`, and `GTCNVDFILT` fields in the output of the `rtrv-stpopts` command.

The ANSI/ITU SCCP Conversion Feature must be enabled to change these parameter values with the `chg-stpopts` command. The `CNVCGDA`, `CNVCGDI`, `CNVCGDN`, `CNVCGDN24`, and `GTCNVDFILT` fields in the output of the `rtrv-stpopts` command are shown when the ANSI/ITU SCCP Conversion feature is enabled. If the `CNVCGDA`, `CNVCGDI`, `CNVCGDN`, `CNVCGDN24`, and `GTCNVDFILT` fields are not shown in the output of the `rtrv-stpopts` command, perform the [Activating the ANSI/ITU SCCP Conversion Feature](#) procedure to enable the ANSI/ITU SCCP Conversion feature.



Note:

The ANSI/ITU SCCP Conversion feature can only be permanently enabled.



Note:

If the value of the `CNVCGDA`, `CNVCGDI`, or `CNVCGDN` value in the `rtrv-stpopts` output is `no` when this procedure is completed, and the calling party address of the MSU cannot be converted when the MSU is processed, then the MSU is discarded.

1. Display the existing values for the ANSI/ITU SCCP Conversion feature options by entering the `rtrv-stpopts` command.

This is an example of the possible output.

```
rlghncxa03w 07-05-17 16:02:05 GMT EAGLE5 37.0.0
STP OPTIONS
-----
CNVCGDA                no
CNVCGDI                no
CNVCGDN                no
```

CNVCMDN24	no
GTCNVDFLT	no

 **Note:**

The `rtrv-stpopts` command output contains other fields that are not used by this procedure. If you wish to see all the fields displayed by the `rtrv-stpopts` command, refer to the `rtrv-stpopts` command description in the *Commands Manual*.

If the `CNVCMDA`, `CNVCMDI`, `CNVCMDN`, `CNVCMDN24`, and `GTCNVDFLT` fields are not shown in the output of the `rtrv-stpopts` command, perform the [Activating the ANSI/ITU SCCP Conversion Feature](#) procedure to enable the ANSI/ITU SCCP Conversion feature. After the ANSI/ITU SCCP Conversion feature has been enabled, the values for these options will be `no`.

 **Note:**

The ANSI/ITU SCCP Conversion feature can only be permanently enabled.

2. Change the ANSI/ITU SCCP Conversion feature options by entering the `chg-stpopts` command with at least one of these parameters.

- `:on=cnvcgda` - if the current value is `no`
- `:on=cnvcgdi` - if the current value is `no`
- `:on=cnvcgdn` - if the current value is `no`
- `:on=cnvcgdn24` - if the current value is `no`
- `:on=gtcnvdf1t` - if the current value is `no`
- `:off=cnvcgda` - if the current value is `yes`
- `:off=cnvcgdi` - if the current value is `yes`
- `:off=cnvcgdn` - if the current value is `yes`
- `:off=cnvcgdn24` - if the current value is `yes`
- `:off=gtcnvdf1t` - if the current value is `yes`

For this example, enter this command.

```
chg-stpopts:on=cnvcgdi:on=gtcnvdf1t
```

When this command has successfully completed, this message should appear.

```
rlghncxa03w 07-05-07 00:22:57 GMT EAGLE5 37.0.0
CHG-STPOPTS: MASP A - COMPLTD
```

3. Verify the changes using the `rtrv-stpopts` command.

This is an example of the possible output.

```
rlghncxa03w 07-05-17 16:02:05 GMT EAGLE5 37.0.0
STP OPTIONS
-----
CNVCGDA          no
CNVCGDI          yes
CNVCGDN          no
CNVCGDN24        no
GTCNVDFLT        yes
```

 **Note:**

The `rtrv-stpopts` command output contains other fields that are not used by this procedure. If you wish to see all the fields displayed by the `rtrv-stpopts` command, refer to the `rtrv-stpopts` command description in *Commands Manual*.

4. Back up the new changes using the `chg-db:action=backup:dest=fixed` command.

These messages should appear, the active Maintenance and Administration Subsystem Processor (MASP) appears first.

```
BACKUP (FIXED) : MASP A - Backup starts on active MASP.
BACKUP (FIXED) : MASP A - Backup on active MASP to fixed disk
complete.
BACKUP (FIXED) : MASP A - Backup starts on standby MASP.
BACKUP (FIXED) : MASP A - Backup on standby MASP to fixed disk
complete.
```

Figure 2-167 Change the ANSI/ITU SCCP Conversion Options

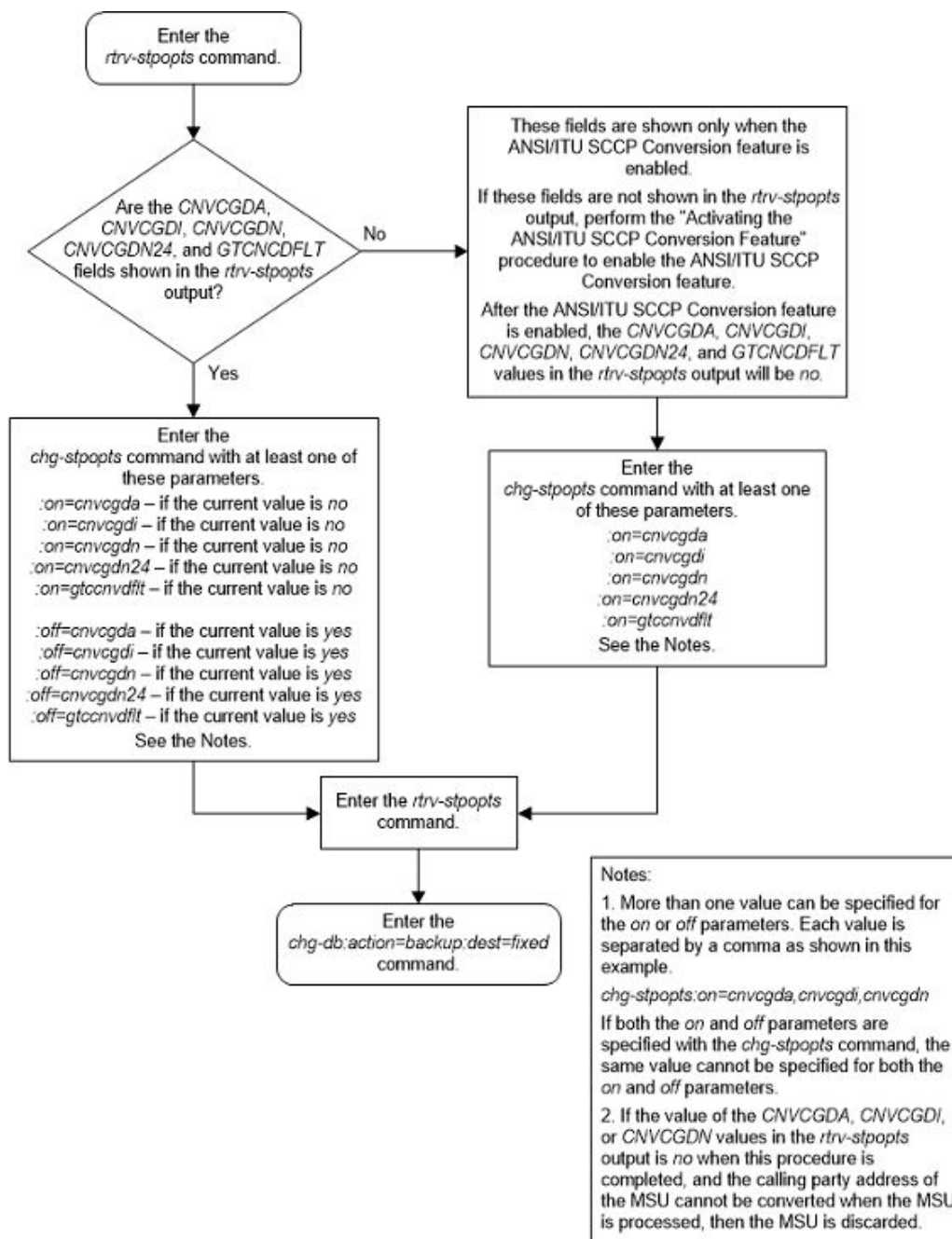

Changing SCCP Class 1 Sequencing Option

This procedure is used to change the option for sequencing UDT/XUDT Class 1 messages using the `chg-sccpopts` command and the `class1seq` parameter. The `class1seq` parameter has two values `on` and `off`.

When the `class1seq` parameter value is `on`, UDT/XUDT Class 1 messages are delivered to the remote node in the order in which they were received (in sequence).

Load sharing of these messages is performed in the dominant mode, overriding the load sharing configuration in the MAP and MRN tables.

Delivering the UDT/XUDT Class 1 ITU messages in sequence is guaranteed only if the `randsls` parameter value of the `chg-stpopts` command is either `off` or `class0`. If you wish to guarantee delivering these messages in sequence, the `class1seq=on` and the `randsls=all` parameters should not be used together in the EAGLE. The value of the `randsls` parameter is shown in the `rtrv-stpopts` command.

When the `class1seq` parameter value is `off`, load sharing of the UDT/XUDT Class 1 messages is performed using the load sharing configuration in the MAP and MRN tables. The delivery of the UDT/XUDT Class 1 messages in sequence is not guaranteed.

1. Display the existing value for the `class1seq` parameter by entering the `rtrv-sccpopts` command. This is an example of the possible output.

```
rlghncxa03w 07-05-17 16:02:05 GMT EAGLE5 37.0.0
SCCP OPTIONS
-----
CLASS1SEQ                off
DFLTGTTMODE              CdPA
```

2. Verify the value of the `randsls` parameter of the `chg-stpopts` command by entering the `rtrv-stpopts` command.

 **Note:**

If the `class1seq` parameter value in step 1 is `on`, skip step 2 and 3, and go to step 4.

This is an example of the possible output.

```
rlghncxa03w 07-05-17 16:02:05 GMT EAGLE5 37.0.0
STP OPTIONS
-----
RANDSLS                  class0
```

 **Note:**

The `rtrv-stpopts` command output contains other fields that are not used by this procedure. If you wish to see all the fields displayed by the `rtrv-stpopts` command, refer to the `rtrv-stpopts` command description in *Commands User's Guide*.

Delivering the UDT/XUDT Class 1 ITU messages in sequence is guaranteed only if the `randsls` parameter value of the `chg-stpopts` command is either `off` or `class0` and if the `class1seq` parameter value is `on`. If you wish to guarantee delivering these messages in sequence, the `class1seq=on` and the `randsls=all` parameters should not be used together in the EAGLE.

3. Change the `randsls` parameter value to either `off` or `class0`. Refer to the “Configuring the EAGLE for Random SLS Generation” procedure in *Database Administration - SS7 User's Guide* for more information on using the `off` and `class0` options. For this example, enter this command.

 **Note:**

If the `randsls` parameter value shown in step 2 is either `off` or `class0`, or if you wish to use the `randsls=all` parameter and the `class1seq=on` parameters, skip step 3 and go to step 4.

```
chg-stpopts:randsls=class0
```

When this command has successfully completed, this message should appear.

```
rlghncxa03w 07-05-07 00:22:57 GMT EAGLE5 37.0.0
CHG-STPOPTS: MASP A - COMPLTD
```

4. Change the `class1seq` parameter value.

If you wish to enable the sequencing of UDT/XUDT Class 1 messages, enter this command.

```
chg-sccpopts:class1seq=on
```

If you wish to disable the sequencing of UDT/XUDT Class 1 messages, enter this command.

```
chg-sccpopts:class1seq=off
```

When the `chg-sccpopts` command has successfully completed, this message should appear.

```
rlghncxa03w 07-05-07 00:22:57 GMT EAGLE5 37.0.0
CHG-SCCPOPTS: MASP A - COMPLTD
```

5. Verify the changes using the `rtrv-sccpopts` command. This is an example of the possible output.

```
rlghncxa03w 07-05-17 16:02:05 GMT EAGLE5 37.0.0

SCCP OPTIONS
-----
CLASS1SEQ                on
DFLTGTTMODE              CdPA
```

6. Back up the new changes using the `chg-db:action=backup:dest=fixed` command. These messages should appear, the active Maintenance and Administration Subsystem Processor (MASP) appears first.

```
BACKUP (FIXED) : MASP A - Backup starts on active MASP.
BACKUP (FIXED) : MASP A - Backup on active MASP to fixed disk
complete.
BACKUP (FIXED) : MASP A - Backup starts on standby MASP.
```

BACKUP (FIXED) : MASP A - Backup on standby MASP to fixed disk complete.

Figure 2-168 Change SCCP Class 1 Sequencing Option - Sheet 1 of 2

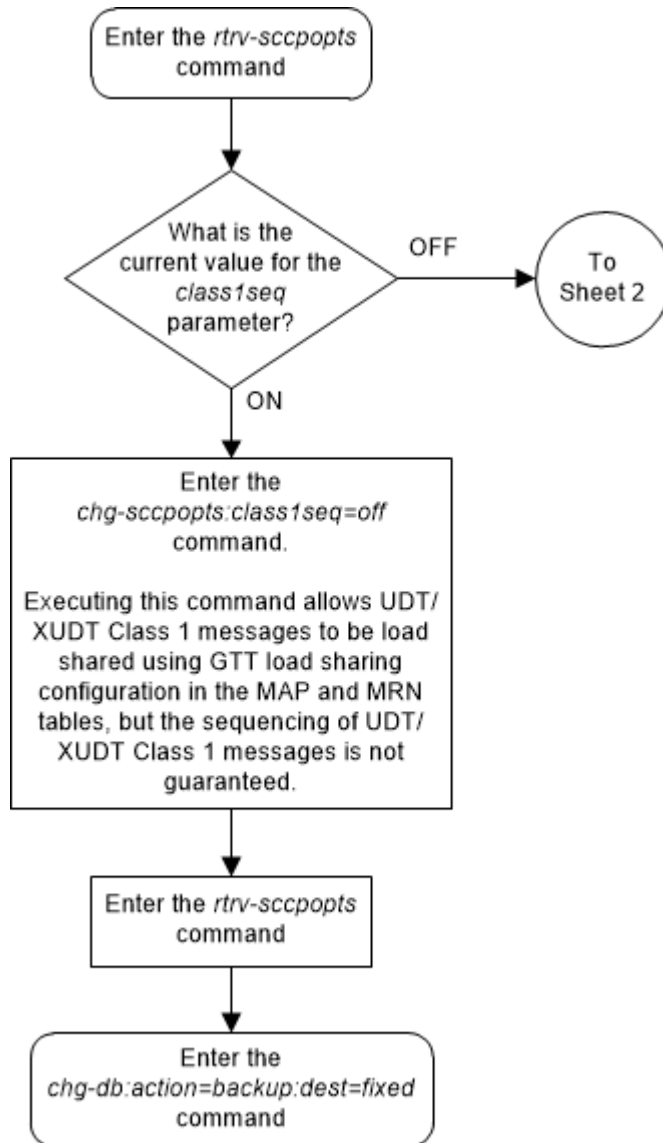
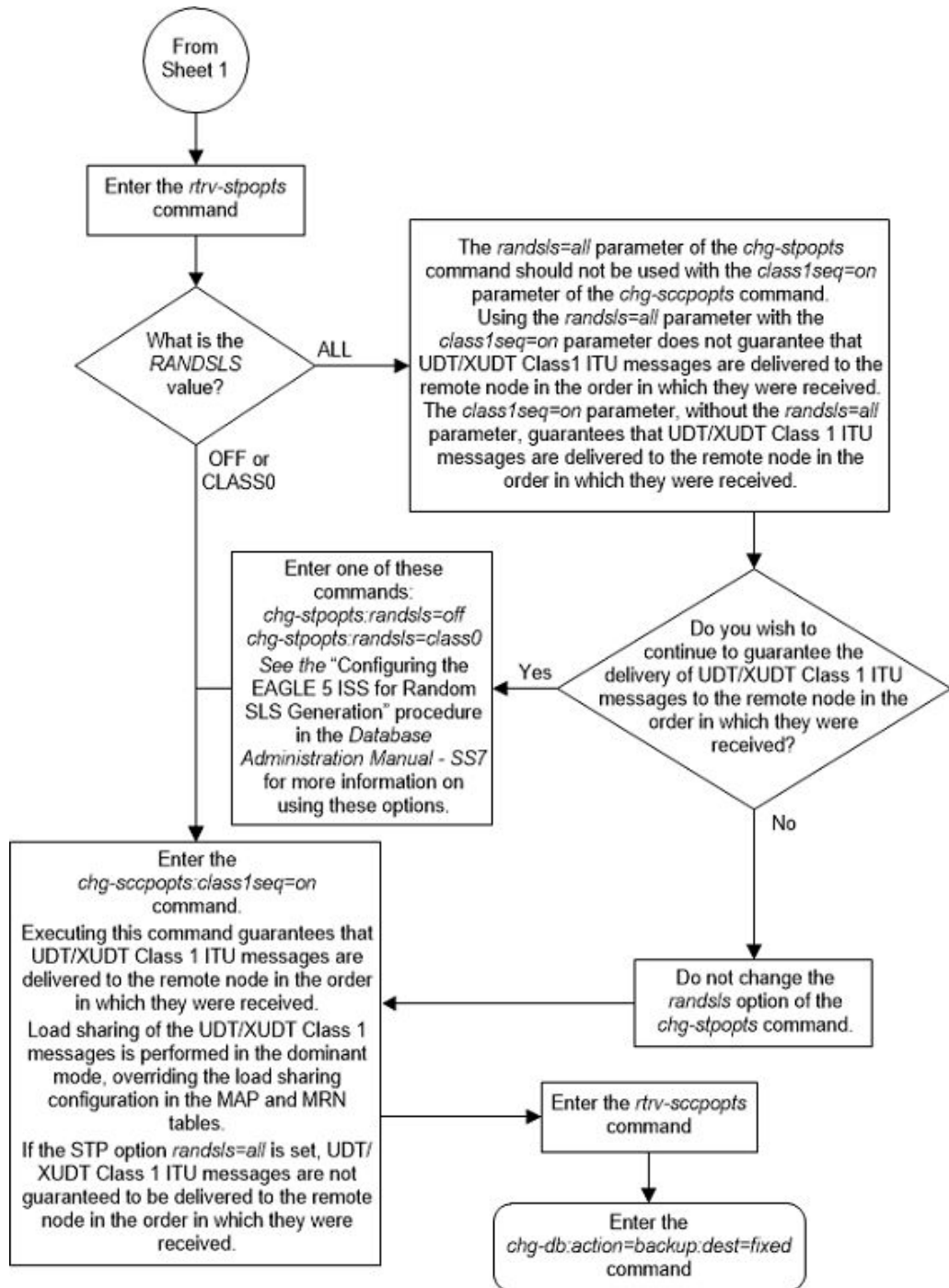

Figure 2-169 Change SCCP Class 1 Sequencing Option - Sheet 2 of 2



Changing the SCCP Alarm Thresholds

This procedure is used to change the SCCP alarm thresholds using the `chg-th-alm` command and these parameters.

`:sccptpscap` – The percentage for the SCCP load capacity (TPS) threshold alarm, from 0 to 100 and is shown in the `SCCP TPS Threshold` field of the `rtrv-th-alm` output and in the `System TPS Alarm Threshold` field in the `rept-stat-sccp` output. The system default value is 80. When this threshold is exceeded, UAM 330 is generated.

`:sccpcalcmtld` – The calculation method used for determining if the SCCP load capacity (TPS) threshold alarm level has been exceeded. This parameter contains these values:

- `N` – All in-service normal cards are used in the SCCP load capacity (TPS) threshold alarm level calculation.
- `NPLUS1` – All in-service normal cards minus one of the in-service normal card with the highest TPS capacity are used in the SCCP load capacity (TPS) threshold alarm level calculation.

The system default value is `N`.

The value of this parameter is shown in the `SCCP Calculation Method` field of the `rtrv-th-alm` output and in the `System SCCP Capacity Calc. Method` field in the `rept-stat-sccp` output.

The service modules that can be used are SMs and E5-SM4Gs. Each type of service module supports a certain number of transactions per second (TPS), SMs - 1700, and E5-SM4G - 1700 or 5000 if the E5-SM4G Throughput Capacity feature is enabled. If the `sccpcalcmtld=n` parameter is specified, the value in the `System SCCP Capacity Calc. Method` field in the `rept-stat-sccp` output is the sum of the TPS ratings of all the in-service normal service modules, shown with the entry `IS-NR` in the `PST` column in the `rept-stat-sccp` output.

If the `sccpcalcmtld=nplus1` parameter is specified, the value in the `System SCCP Capacity Calc. Method` field in the `rept-stat-sccp` output is the sum of the TPS ratings of all the in-service normal service modules, shown with the entry `IS-NR` in the `PST` column in the `rept-stat-sccp` output, minus the TPS rating of the highest rated in-service normal card. If the EAGLE contains only SMs, or only E5-SM4Gs as service modules, then the TPS rating of one of the SM or SLIC cards, as applicable, is subtracted from the sum of the TPS ratings of all the in-service normal service modules. If the EAGLE contains SMs or SLIC, then the TPS rating of one of the cards is subtracted from the sum of the TPS ratings of all the in-service normal service modules.

`:gttserv11` – The percentage of the SCCP GTT service errors, shown in the `FAIL RATIO` column for the `GTT` row of the `TOTAL SERVICE STATISTICS:` section of the `rept-stat-sccp` output, from 1 to 100, that when exceeded, generates major alarm UAM 0452. The system default value is 10.

`:gttserv12` – The percentage of the SCCP GTT service errors, shown in the `FAIL RATIO` column for the `GTT` row of the `TOTAL SERVICE STATISTICS:` section of the `rept-stat-sccp` output, from 1 to 100, that when exceeded, generates critical alarm UAM 0453. The system default value is 20.

 **Note:**

After the `chg-th-alm` command is performed, the `gttserv12` parameter value must be greater than the `gttserv11` parameter value.

`:nongttservl1` – The percentage of the SCCP non-GTT service errors (for example, GPORT, GFLEX, EIR, etc.), shown in the `FAIL_RATIO` column for the rows other than `GTT` in the `TOTAL_SERVICE_STATISTICS:` section of the `rept-stat-sccp` output, from 1 to 100, that when exceeded, generates major alarm UAM 0452. The system default value is 10.

`:nongttservl2` – The percentage of the SCCP non-GTT service errors (for example, GPORT, GFLEX, EIR, etc.), shown in the `FAIL_RATIO` column for the rows other than `GTT` in the `TOTAL_SERVICE_STATISTICS:` section of the `rept-stat-sccp` output, from 1 to 100, that when exceeded, generates critical alarm UAM 0453. The system default value is 20.

 **Note:**

After the `chg-th-alm` command is performed, the `nongttservl2` parameter value must be greater than the `nongttservl1` parameter value.

`:sccpthlv1intvl` - The number of minutes, from 0 to 1440, during which the SCCP threshold level 1 alarm (UAM 0452) cannot be raised more than once. The system default value is 0.

`:sccpthlv2intvl` - The number of minutes, from 0 to 1440, during which the SCCP threshold level 2 alarm (UAM 0453) cannot be raised more than once. The system default value is 0.

 **Note:**

After the `chg-th-alm` command is performed, the `sccpthlv2intvl` parameter value must be greater than the `sccpthlv1intvl` parameter value.

For more information on these alarms, refer to *Unsolicited Alarm and Information Messages Reference*.

The `chg-th-alm` command contains other optional parameters. These parameters are not shown here because they are not necessary to provision the SCCP alarm thresholds. These parameters are explained in more detail in *Commands User's Guide*.

1. Display the current SCCP alarm thresholds in the database by entering the `trv-th-alm` command. This is an example of the possible output.

```
rlghncxa03w 08-03-28 09:12:36 GMT EAGLE5 38.0.0
SCCP TPS Threshold:                80%
SCCP Calculation Method:           N
GTT SCCP Service Alarm Level 1:    10%
GTT SCCP Service Alarm Level 2:    20%
Non-GTT SCCP Service Alarm Level 1: 10%
Non-GTT SCCP Service Alarm Level 2: 20%
SCCP Service Alarm Level 1 Interval: 0
```

```
SCCP Service Alarm Level 2 Interval: 0  
Command Executed
```

 **Note:**

The `rtrv-th-alm` command output contains other fields that are not used in this procedure. If you wish to see all the fields displayed by the `rtrv-th-alm` command, refer to the `rtrv-th-alm` command description in *Commands User's Guide*.

2. Change the SCCP alarm thresholds by entering the `chg-th-alm` command with at least one of the SCCP alarm threshold parameters.

If a SCCP alarm threshold parameter is not specified with the `chg-th-alm` command, that parameter value will not be changed. The system default values for the SCCP alarm threshold parameters are:

- `sccptpscap` – 80
- `sccpcalcmtld` – n
- `gttservl1` – 10
- `gttservl2` – 20
- `nongttservl1` – 10
- `nongttservl2` – 20
- `sccpthlv1intvl` – 10
- `sccpthlv2intvl` – 20.

 **Note:**

After the `chg-th-alm` command is performed, the `gttservl2` parameter value must be greater than the `gttservl1` parameter value, the `nongttservl2` parameter value must be greater than the `nongttservl1` parameter value, and the `sccpthlv2intvl` parameter value must be greater than the `sccpthlv1intvl` parameter value.

For this example, enter this command.

```
chg-th-  
alm:sccptpscap=70:gttservl1=70:gttservl2=80:nongttservl1=30:n  
ongttservl2=40 :sccpthlv1intvl=120:sccpthlv2intvl=240
```

When this command has successfully completed, this message should appear.

```
rlghncxa03w 07-05-28 09:12:36 GMT EAGLE5 37.0.0  
CHG-TH-ALM: MASP A - COMPLTD
```

3. Verify the changes using the `rtrv-th-alm` command. This is an example of the possible output.

```
rlghncxa03w 08-3-28 09:12:36 GMT EAGLE5 38.0.0
SCCP TPS Threshold:                70%
SCCP Calculation Method:           N
GTT SCCP Service Alarm Level 1:    70%
GTT SCCP Service Alarm Level 2:    80%
Non-GTT SCCP Service Alarm Level 1: 30%
Non-GTT SCCP Service Alarm Level 2: 40%
SCCP Service Alarm Level 1 Interval: 120
SCCP Service Alarm Level 2 Interval: 240
Command Executed
```

 **Note:**

The `rtrv-th-alm` command output contains other fields that are not used in this procedure. If you wish to see all the fields displayed by the `rtrv-th-alm` command, refer to the `rtrv-th-alm` command description in *Commands User's Guide*.

4. Backup the new changes using the `chg-db:action=backup:dest=fixed` command.

These messages should appear, the active Maintenance and Administration Subsystem Processor (MASP) appears first.

```
BACKUP (FIXED) : MASP A - Backup starts on active MASP.
BACKUP (FIXED) : MASP A - Backup on active MASP to fixed disk
complete.
BACKUP (FIXED) : MASP A - Backup starts on standby MASP.
BACKUP (FIXED) : MASP A - Backup on standby MASP to fixed disk
complete.
```

Figure 2-170 Change the SCCP Alarm Thresholds

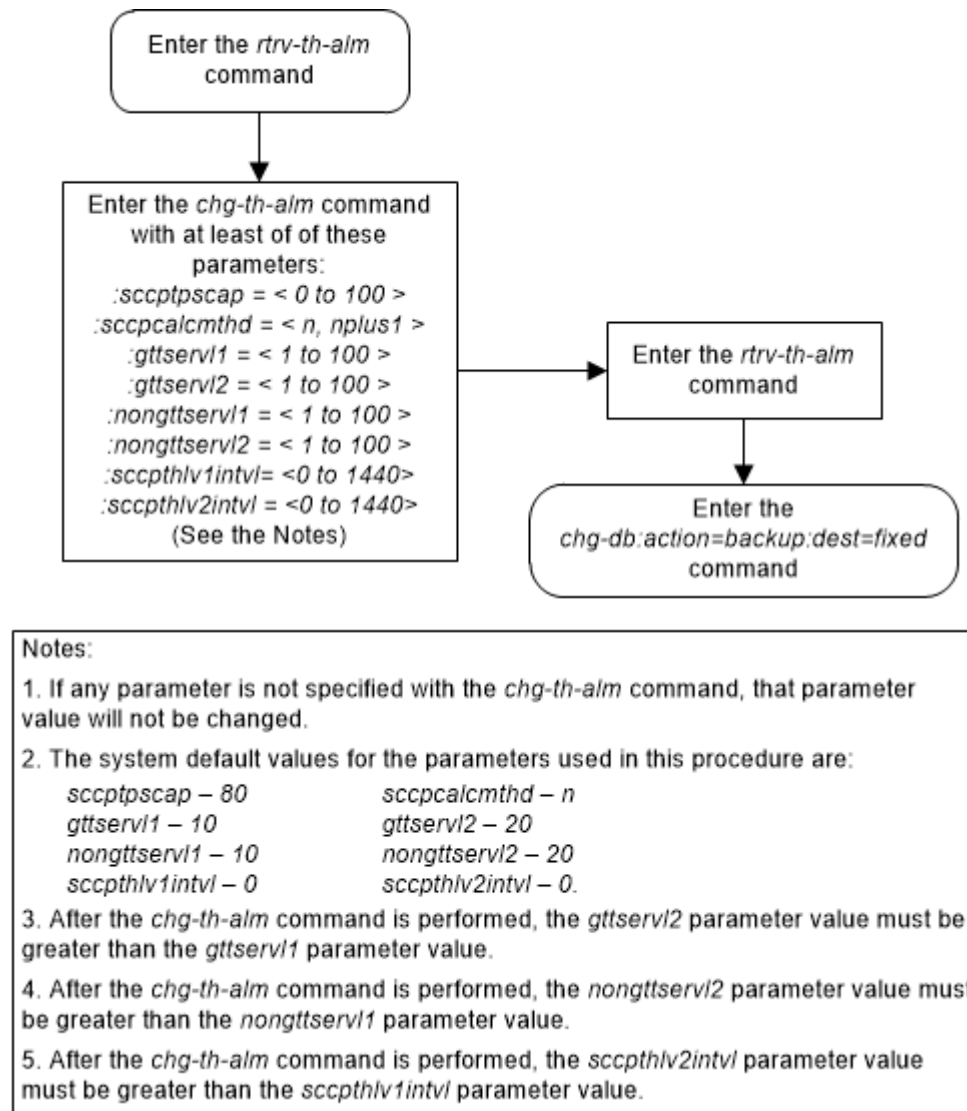

Changing the Transaction-Based GTT Load Sharing Options

This procedure is used to change the options for performing Transaction-Based GTT Load Sharing using the *chg-sccpopts* command and with these parameters:

:tgtt0 – enable or disable Transaction-Based GTT Load Sharing for SCCP Class 0 UDT, UDTS, XUDT, or XUDTS messages. The values for this parameter are:

- *udt* – Transaction-Based GTT Load Sharing is performed for Class 0 UDT or UDTS messages.
- *xudt* – Transaction-Based GTT Load Sharing is performed for Class 0 XUDT or XUDTS messages.
- *both* – Transaction-Based GTT Load Sharing is performed for Class 0 UDT, UDTS, XUDT and XUDTS messages.

- `none` – Transaction-Based GTT Load Sharing is not performed for SCCP Class 0 messages.

`:tggt1` – enable or disable Transaction-Based GTT Load Sharing for SCCP Class 1 UDT, UDTS, XUDT, or XUDTS messages. The values for this parameter are:

- `udt` – Transaction-Based GTT Load Sharing is performed for Class 1 UDT or UDTS messages.
- `xudt` – Transaction-Based GTT Load Sharing is performed for Class 1 XUDT or XUDTS messages.
- `both` – Transaction-Based GTT Load Sharing is performed for Class 1 UDT, UDTS, XUDT and XUDTS messages.
- `none` – Transaction-Based GTT Load Sharing is not performed for SCCP Class 1 messages.

`:tggtudtkey` – the Transaction Parameter for the incoming UDT or UDTS messages. The values for this parameter are:

- `mtp` – Transaction-Based GTT Load Sharing is performed on the MTP parameter for UDT and UDTS messages.
- `sccp` – Transaction-Based GTT Load Sharing is performed on the SCCP parameter for UDT and UDTS messages.
- `tcap` – Transaction-Based GTT Load Sharing is performed on the TCAP parameter for UDT and UDTS messages.
- `enhmtp` – Transaction-Based GTT Load Sharing is performed using the enhanced MTP algorithm for UDT and UDTS messages.

`:tggtxudtkey` – the Transaction Parameter for the incoming XUDT or XUDTS messages. The values for this parameter are:

- `mtp` – Transaction-Based GTT Load Sharing is performed on the MTP parameter for XUDT and XUDTS messages.
- `sccp` – Transaction-Based GTT Load Sharing is performed on the SCCP parameter for XUDT and XUDTS messages.
- `enhmtp` – Transaction-Based GTT Load Sharing is performed using the enhanced MTP algorithm for XUDT and XUDTS messages.

The Transaction-Based GTT Load Sharing feature must be enabled to change these parameter values with the `chg-sccpopts` command. The `tggt0`, `tggt1`, `tggtudtkey`, and `tggtxudtkey` fields in the output of the `rtrv-sccpopts` command are shown when the Transaction-Based GTT Load Sharing feature is enabled. If the `tggt0`, `tggt1`, `tggtudtkey`, and `tggtxudtkey` fields are not shown in the output of the `rtrv-sccpopts` command, perform the [Activating the Transaction-Based GTT Load Sharing Feature](#) procedure to enable the Transaction-Based GTT Load Sharing feature.

When the Transaction-Based GTT Load Sharing feature is enabled, these values for the `tggt0`, `tggt1`, `tggtudtkey`, and `tggtxudtkey` fields are shown in the `rtrv-sccpopts` output:

- `tggt0` – `none`
- `tggt1` – `none`
- `tggtudtkey` – `mtp`

- `tgtxudtkey – mtp`.

If any parameter is not specified with the `chg-sccpopts` command, that parameter value will not be changed.

If the value `both` is specified for the `tggt0` or `tggt1` parameters, the entry `UDT, XUDT` is shown in the `tggt0` or `tggt1` fields of the `rtrv-sccpopts` output.

For more information on the Transaction-Based GTT Load Sharing feature, refer to the [Transaction-Based GTT Load Sharing](#) section.

1. Display the existing values for the Transaction-Based GTT Load Sharing feature options by entering the `rtrv-sccpopts` command. This is an example of the possible output.

```
rlghncxa03w 08-09-17 16:02:05 GMT  EAGLE5 39.2.0
SCCP OPTIONS
-----
tggt0                NONE
tggt1                NONE
tggtudtkey           MTP
tgtxudtkey           MTP
```

Note:

The `rtrv-sccpopts` command output contains other fields that are not used by this procedure. If you wish to see all the fields displayed by the `rtrv-sccpopts` command, refer to the `rtrv-sccpopts` command description in *Commands User's Guide*.

If the `tggt0`, `tggt1`, `tggtudtkey` and `tgtxudtkey` fields are not shown in the output of the `rtrv-sccpopts` command, the Transaction-Based GTT Load Sharing feature is not enabled. For these fields to be shown in the `rtrv-sccpopts` output, and to change these values, the Transaction-Based GTT Load Sharing feature must be enabled. Perform the [Activating the Transaction-Based GTT Load Sharing Feature](#) procedure to enable the Transaction-Based GTT Load Sharing feature.

2. Change the Transaction-Based GTT Load Sharing feature options by entering the `chg-sccpopts` command with at least one of the Transaction-Based GTT Load Sharing parameters. For this example, enter this command.

```
chg-
sccpopts:tggt0=udt:tggt1=both:tggtudtkey=tcap:tgtxudtkey=enh
mtp
```

If any parameter is not specified with the `chg-sccpopts` command, that parameter value will not be changed.

When the `chg-sccpopts` command has successfully completed, this message should appear.

```
rlghncxa03w 08-09-07 00:22:57 GMT  EAGLE5 39.2.0
CHG-SCCPOPTS: MASP A - COMPLTD
```

3. Verify the changes using the `rtrv-sccpopts` command. This is an example of the possible output.

```
rlghncxa03w 08-09-17 16:02:05 GMT EAGLE5 39.2.0
```

```
SCCP OPTIONS
```

```
-----  

tgtt0                UDT  

tgtt1                UDT,XUDT  

tgttudtkey          TCAP  

tgtxudtkey          ENHMTF
```

 **Note:**

The `rtrv-sccpopts` command output contains other fields that are not used by this procedure. If you wish to see all the fields displayed by the `rtrv-sccpopts` command, refer to the `rtrv-sccpopts` command description in *Commands User's Guide*.

4. Back up the new changes using the `chg-db:action=backup:dest=fixed` command. These messages should appear, the active Maintenance and Administration Subsystem Processor (MASP) appears first.

```
BACKUP (FIXED) : MASP A - Backup starts on active MASP.  

BACKUP (FIXED) : MASP A - Backup on active MASP to fixed disk  

complete.  

BACKUP (FIXED) : MASP A - Backup starts on standby MASP.  

BACKUP (FIXED) : MASP A - Backup on standby MASP to fixed disk  

complete.
```

Figure 2-171 Change the Transaction-Based GTT Load Sharing Options

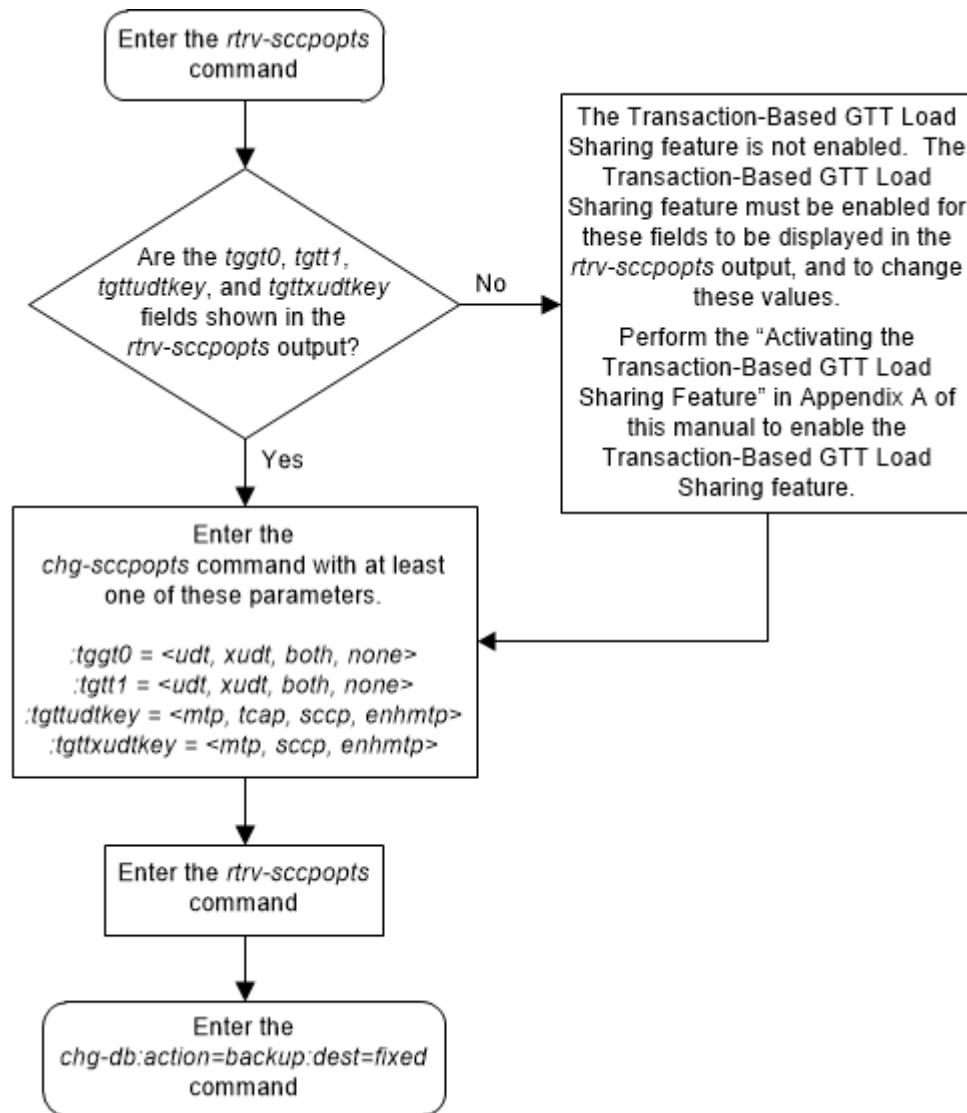

Adding a Loopset

This procedure is used to add a loopset to the database using the `ent-loopset` command.

The `ent-loopset` command uses these parameters.

`:name` - The name of the loopset. The loopset name can contain up to 8 characters, with the first character being a letter.

`:pc1/pc1a/pc1i/pc1n/pc1n24` - The point codes assigned to the specified loopset, either an ANSI point (`pc1/pc1a`), ITU-1 or ITU-1 spare point (`pc1i`), a 14-bit ITU-N or 14-bit ITU-N spare point code (`pc1n`), or a 24-bit ITU-N (`pc1n24`) point code.

 **Note:**

See Chapter 2, *Configuring Destination Tables* in *Database Administration - SS7 User's Guide* for a definition of the point code types that are used on the EAGLE and for the definition of the different formats that can be used for ITU national point codes.

`:mode` - Mode of operation. Can be notify or discard. This is an optional parameter that specifies whether the message is discarded when an SCCP loop is detected. The "Notify only" mode of operation generates UIMs but not actually discard the message, which allows a user to capture and verify messages. However, the "Discard" mode of operation generates the UIMs and also discard the MSUs.

To add a loopset to the database, the SCCP Loop Detection feature must be enabled. The `rtrv-ctrl-feat` command output shows whether or not the SCCP Loop Detection feature is enabled. If the SCCP Loop Detection feature is not enabled, perform the [Activating the SCCP Loop Detection Feature](#) procedure to enable this feature.

All the point codes specified with the `pc1/pc1a/pc1i/pc1n/pc1n24` parameter must be the same type of point code. The point code values are separated by commas with no spaces between the commas and the point code values as shown in the example `pc1=002-002-002,003-003-003,004-004-004`. This example specified three ANSI point codes for the loopset.

A maximum of twelve point codes can be assigned to a single loopset. However, this procedure can be used to assign a maximum of six point codes to a single loopset. If you wish to add more point codes to the loopset entries, perform the [Changing the Attributes of a Loopset](#) procedure.

A maximum of 1000 loopsets can be assigned to a loopset database. If adding the new loopset entries exceed the maximum capacity of the loopset table displayed in the `rtrv-loopset` command output, entries in the loopset table must be removed to ensure that the new loopset entries can be added. Perform the [Removing a Loopset](#) procedure to remove the required number of loopset entries

1. Display the loopsets in the database by entering this command.

```
rtrv-loopset:num=1000:force=yes
This is an example of the possible output.
```

```
rlghncxa03w 06-10-18 08:52:38 GMT EAGLE Rel 35.6.0
```

LoopSet	Mode	Point Codes
rtpl	notify	005-005-005 007-007-007 (ANSI) 003-004-003 003-007-003 005-007-005 007-004-007 003-003-009

```
LOOPSET table is (1 of 1000) 1% full
```

 **Note:**

If the `rtrv-loopset` command is entered with no other parameters specified, a maximum of 50 entries are displayed. To display more than 50 entries, the `force=yes` parameter must be specified with the `rtrv-loopset` command and the `num` parameter value must be greater than 50. Since there can be a maximum of 1000 loopsets in the database, to display all the loopsets in the database, the `force=yes` and `num=1000` parameters must be specified with the `rtrv-loopset` command.

2. If error message E4565 is displayed after the `rtrv-loopset` command is executed, the SCCP Loop Detection feature is not enabled.

If the SCCP Loop Detection feature is not enabled, perform the [Activating the SCCP Loop Detection Feature](#) procedure to enable the SCCP Loop Detection feature. If error message E2584 is displayed after the `rtrv-loopset` command is executed, the GTT feature is not on. Perform the [Activating the SCCP Loop Detection Feature](#) procedure to turn the GTT feature on and enable the SCCP Loop Detection feature.

3. The EAGLE can contain a maximum of 1000 loopset. If the `rtrv-loopset` output in step 1 show 1000 loopsets, enough loopsets must be removed from the database to allow the new loopsets to be added.

Perform the [Removing a Loopset](#) procedure and remove the required number of loopsets to allow the addition of the new loopsets. If no loopsets are removed, the new loopsets cannot be added and this procedure cannot be performed.

4. Add the loopset to the database using the `ent-loopset` command.

For this example, enter this command

```
ent-loopset:name=rtp2:pc1=2-2-2,3-3-3,4-4-4,5-5-5
```

When this command has successfully completed, this message should appear.

```
rlghncxa03w 06-10-18 08:31:28 GMT EAGLE Rel 35.6.0
```

```
LOOPSET table is (12 of 1000) 1% full
ENT-LOOPSET: MASP A - COMPLTD
```

5. Verify the changes using the `rtrv-loopset` command with the loopset name specified in step 4.

For this example, enter this command.

```
rtrv-loopset:name=rtp2
```

This is an example of the possible output.

```
rlghncxa03w 06-10-18 08:31:28 GMT EAGLE Rel 35.6.0
```

```
LoopSet      Mode      Point Codes
=====
rtp2         notify    002-002-002      003-003-003      (ANSI)
                                004-004-004      005-005-005
```

```
LOOPSET table is (2 of 1000) 1% full
```

6. Backup the new changes using the `chg-db:action=backup:dest=fixed` command.

These messages should appear, the active Maintenance and Administration Subsystem Processor (MASP) appears first.

```
BACKUP (FIXED) : MASP A-Backup starts on active MASP.  
BACKUP (FIXED) : MASP A-Backup on active MASP to fixed disk  
complete.  
BACKUP (FIXED) : MASP A-Backup starts on standby MASP.  
BACKUP (FIXED) : MASP A-Backup on standby MASP to fixed disk  
complete.
```

7. A loopset can contain a maximum of 12 point codes. If you wish to add more point codes to this loopset, perform the [Changing the Attributes of a Loopset](#) procedure and add the additional point codes with the `apcl/apcla/apcli/apcln/apcln24` parameter.

If you do not wish to add more point codes to the loopset, this procedure is finished.

Figure 2-172 Add a Loopset to the Database - Sheet 1 of 2

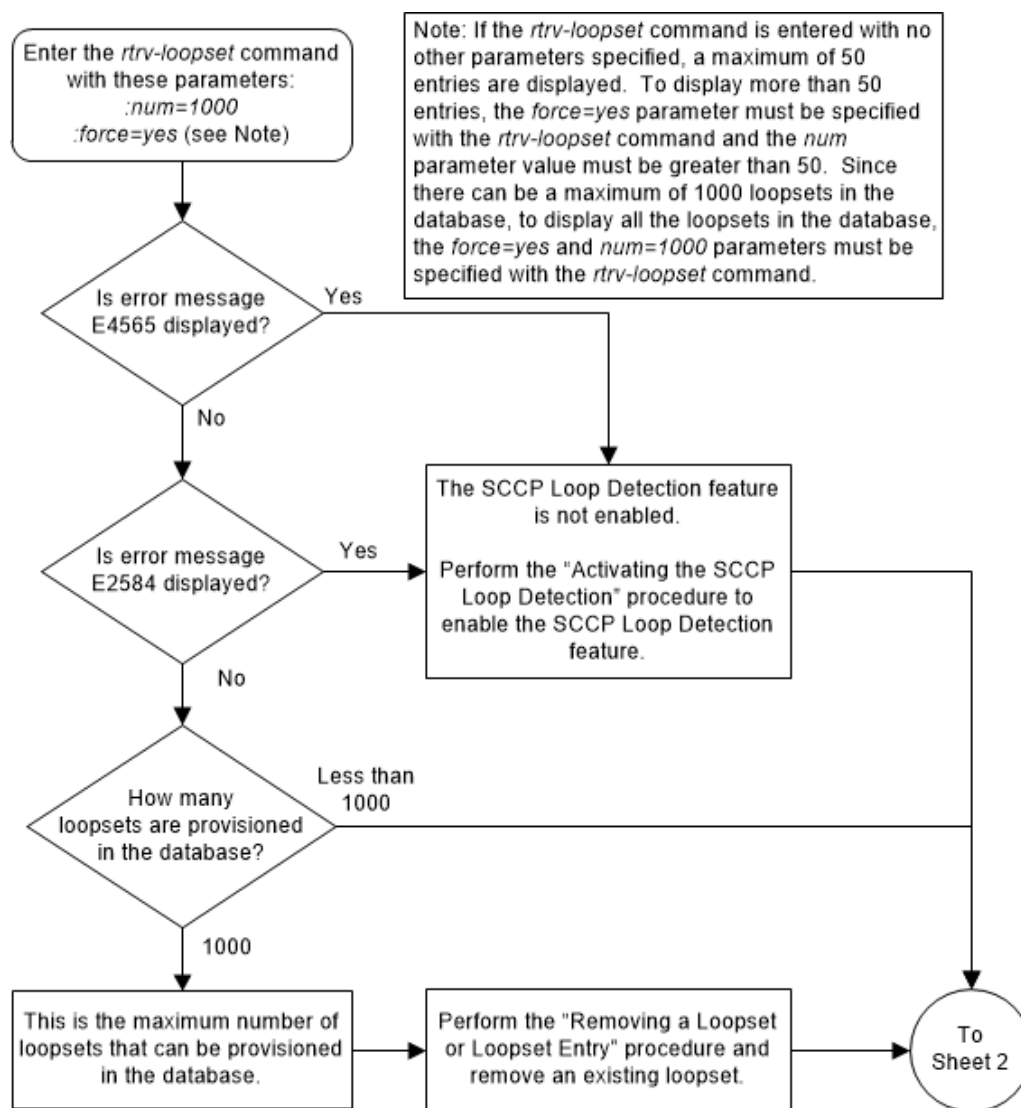
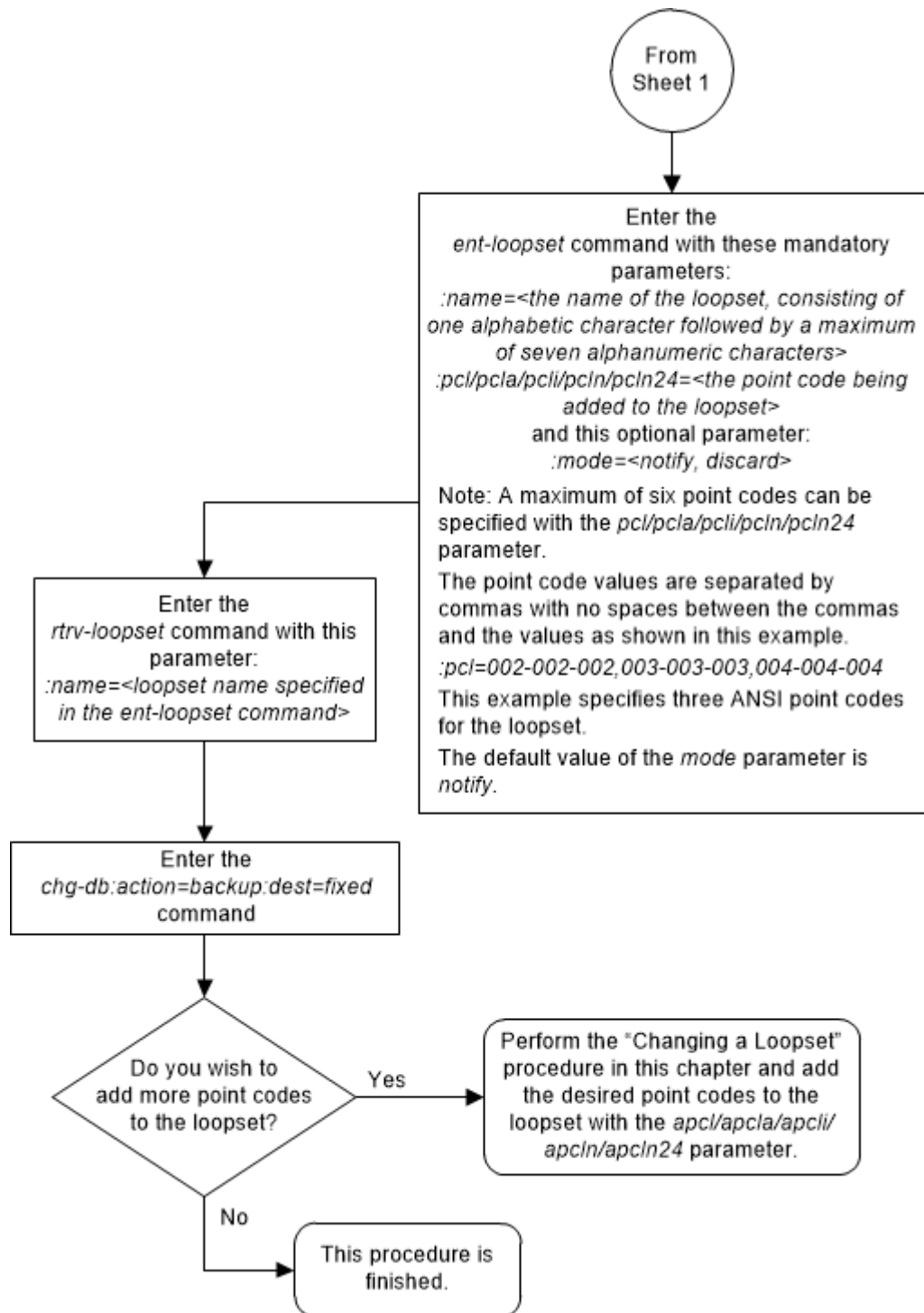

Figure 2-173 Add a Loopset to the Database - Sheet 2 of 2



Removing a Loopset

This procedure is used to remove an entire loopset from the database or a specific point code in a loopset using the `dlt-loopset` command.

The `dlt-loopset` command uses these parameter.

`:name` - The name of the loopset being removed, shown in the `rtrv-loopset` output.

`:force` - This parameter has two values, yes or no. The value yes allows the point code in the loopset to be removed if the loopset is assigned to entries in either the `rtrv-gtt` or `rtrv-gta` outputs. The value no requires that any references to the loopset must be removed from the GTT or GTA entries before the loopset or the point code in the loopset can be removed. Perform one of these procedures to remove the reference to the loopset, depending on whether or not the EGTT feature is on. The status of the EGTT feature is shown in the `rtrv-feat` command output.

- If the EGTT feature is not on – Enter the `rtrv-gtt` command to verify the loopset references. Perform the [Changing a Global Title Translation](#) procedure and change the loopset reference to `NONE` or to another loopset name, or remove the global title translation by performing the [Removing a Global Title Translation](#) procedure.
- If the EGTT feature is on – Enter the `rtrv-gta` command to verify the loopset references. Perform [Changing Global Title Address Information](#) and change the loopset reference to `NONE` or to another loopset name, or remove the entry by performing the [Removing Global Title Address Information](#) procedure.

`:pcl/pcla/pcli/pcln/pcln24` – The point code, either an ANSI point code (`pcl/pcla`), ITU-I or ITU-I spare point code (`pcli`), a 14-bit ITU-N or 14-bit ITU-N spare point code (`pcln`), or a 24-bit ITU-N (`pcln24`) point code, that is assigned to the loopset and shown in the `rtrv-loopset` output.

If the `dlt-loopset` command is specified with the `name` and `pcl/pcla/pcli/pcln/pcln24` parameter, the specified point code is removed from the loopset.

If the `dlt-loopset` command is specified with the `name` parameter and without the `pcl/pcla/pcli/pcln/pcln24` parameter, the entire loopset is removed from the database.

1. Display the loopsets in the database by entering this command. This is an example of the possible output

```
rtrv-loopset:num=1000:force=yes
```

 **Note:**

If the `rtrv-loopset` command is entered with no other parameters specified, a maximum of 50 entries are displayed. To display more than 50 entries, the `force=yes` parameter must be specified with the `rtrv-loopset` command and the `num` parameter value must be greater than 50. Since there can be a maximum of 1000 loopsets in the database, to display all the loopsets in the database, the `force=yes` and `num=1000` parameters must be specified with the `rtrv-loopset` command.

This is an example of the possible output.

```
rlghncxa03w 06-10-18 08:52:38 GMT EAGLE Rel 35.6.0
LoopSet   Mode      Point Codes
=====
```

```

=====
rtp1      notify  005-005-005      007-007-007      (ANSI)
           003-004-003      003-007-003
           005-007-005      007-004-007
           005-004-005

rtp2      notify  002-002-002      003-003-003      (ANSI)
           004-004-004      005-005-005

```

LOOPSET table is (2 of 1000) 1% full

If error message E4565 is displayed or if no loopsets are displayed, this procedure cannot be performed.

 **Note:**

If the `force=yes` parameter will be specified with the `dlt-loopset` command, only a specific point code can be removed from the loopset. Skip steps 2 through 6 and go to step 7.

2. Verify whether or not the EGTT feature is turned on by entering the `rtrv-feat` command. If the EGTT featured is turned on, the EGTT field should be set to on.

 **Note:**

The `rtrv-feat` command output contains other fields that are not used by this procedure. If you wish to know about all the fields displayed by the `rtrv-feat` command, refer to the `rtrv-feat` command description in *Commands User's Guide*.

 **Note:**

If the EGTT feature is not turned on, skip steps 3 and step 4, and go to step 5.

3. Display the GTT sets in the database using the `rtrv-gttset` command. This is an example of the possible output.

```

rlghncxa03w 09-07-07 00:27:31 GMT EAGLE5 41.1.0

GTTSN      NETDOM  SETTYPE  NDGT
setans015  ansi    CDGTA    6
set1       ansi    CDGTA    6

GTT-SET table is (2 of 2000) 1% full.

```

4. Display the global title address (GTA) information for a GTT set from step 3. Execute the `rtrv-gta` command with the `gttsn` parameter value shown in the output of step 3 and with the name of the loopset being removed, specified with the `loopset` parameter. For this example, enter this command.

```
rtrv-gta:gttsn=set1:loopset=rtp1
```

This is an example of the possible output.

```
rlghncxa03w 09-05-07 00:27:31 GMT EAGLE5 41.0.0
```

```
GTTSN      NETDOM  SETTYPE  NDGT
set1       ansi    CDGTA    6
```

```
GTT TABLE IS 1 % FULL (2 of 269999)
```

```
START GTA END GTA  XLAT  RI      PCA
919460   919460  DISC
919461   919461  DPC   SSN    002-002-002
          SSN=--- CCGT=no NTT=---
          LOOPSET = rtp1  FALLBACK=sysdflt TESTMODE=off
          OPTSN=----- CGSELID=----- CDSELID=----- OPCS=-----
```

Command Retrieved 2 Entries

If any of the displayed entries reference the loopset being removed, for those entries, perform [Changing Global Title Address Information](#) and change the loopset reference to `NONE` or to another loopset name, or remove the entry by performing the [Removing Global Title Address Information](#) procedure.

If the displayed entries do not reference the loopset being removed, repeat this step with the other GTT set names displayed in step 3.

When all the GTT set names have been displayed and all applicable global title translation entries have been changed or removed in this step, go to step 7.

5. Display the translation types in the database using the `rtrv-tt` command. This is an example of the possible output.

```
rlghncxa03w 07-03-25 09:42:31 GMT EAGLE5 35.6.0
```

```
TYPEA      TTN      NDGT
1          lidb     5
2          c800    10
3          d700    6
5          scp1    6
10         scp2    6
15         scp3    3
```

```
ALIAS      TYPEA
30         5
40         10
50         3
65         3
```

```
TYPEI      TTN      NDGT
105        itudb   8
```

```
ALIAS      TYPEI
7          105
```

```
TYPEN      TTN      NDGT
```

```

120          dbitu          7

ALIAS        TYPEN
8            120

```

6. Display the global title translations in the database using the `rtrv-gtt` command specifying a translation type from the `rtrv-tt` command output shown in step 5 and with the name of the loopset being removed, specified with the `loopset` parameter. For this example, enter this command.

```
rtrv-gtt:typea=10:loopset=rtpl
```

This is an example of the possible output.

```

rlghncxa03w 08-10-25 09:43:31 GMT  EAGLE5 39.2.0
TYPEA  TTN          NDGT
10     scp2         6

GTT TABLE IS 10 % FULL      (27000 of 269999)

START GTA          END GTA          XLAT  RI      PC
615370             615380          DPCSSN SSN
003-003-003
      MAPSET=6      SSN=254 NGT=---
      LOOPSET = rtpl

```

Command Retrieved 1 Entries

If any of the displayed entries reference the loopset being removed, for those entries, perform the [Changing a Global Title Translation](#) procedure and change the loopset reference to `NONE` or to another loopset name, or remove the global title translation by performing the [Removing a Global Title Translation](#) procedure.

If the displayed entries do not reference the loopset being removed, repeat this step with the other translation types displayed in step 5.

When all the translation types have been displayed and all applicable global title translation entries have been changed or removed in this step, go to step 7.

7. If an entire loopset is being removed from the database, specify the `dlt-loopset` command with the name of the loopset you wish to remove.

If a point code value is being removed from the loopset, specify the `dlt-loopset` command with the name of the loopset and the point code value you wish to remove.

For this example, enter this command to remove the entire loopset.

```
dlt-loopset:name=rtpl
```

This message should appear.

```

rlghncxa03w 06-10-18 08:48:25 GMT  EAGLE Rel 35.6.0
LOOPSET table is (11 of 1000) 1% full
DLT-LOOPSET: MASP A - COMPLTD

```

 **Note:**

If the loopset containing the point code being removed in this step is referenced by an entry shown in either the `rtrv-gtt` or `rtrv-gta` outputs, and those entries have not been removed or the loopset assignment for these entries has not been changed, the `force=yes` parameter must be specified with the `dlt-loopset` command.

If you wish to remove other point codes from the loopset, repeat this step. When you have finished removing the point codes from the loopset, go to step 8.

8. Verify the changes using the `rtrv-loopset` command with the name of the loopset specified in step 7. For this example, enter this command.

```
rtrv-loopset:name=rtpl
```

The following message should appear if you have deleted specific point codes in the loopset.

```
rlghncxa03w 06-10-18 08:52:38 GMT EAGLE Rel 35.6.0
LoopSet   Mode      Point Codes
=====
=====
rtpl      notify  005-005-005      003-004-003      (ANSI)
          003-007-003      005-007-005
          007-004-007
```

The following message should appear if you have deleted an entire loopset.

```
E4568 : Loopset Entry does not exist
```

9. Backup the new changes using the `chg-db:action=backup:dest=fixed` command. These messages should appear, the active Maintenance and Administration Subsystem Processor (MASP) appears first.

```
BACKUP (FIXED) : MASP A - Backup starts on active MASP.
BACKUP (FIXED) : MASP A - Backup on active MASP to fixed disk
complete.
BACKUP (FIXED) : MASP A - Backup starts on standby MASP.
BACKUP (FIXED) : MASP A - Backup on standby MASP to fixed disk
complete.
```

If a point code value was removed from a loopset in step 7 and the `force=yes` was not used in step 7, and you wish to assign this loopset to the GTT or GTA entries that were removed or changed in steps 4 or 6, go to step 10.

If any of the following actions were performed in step 7, this procedure is finished. Do not perform step 10.

- An entire loopset was removed in step 7.
- A point code value was removed from a loopset with the `force=yes` parameter in step 7.

- A point code value was removed from a loopset in step 7, the `force=yes` was not used in step 7, and you do not wish to assign this loopset to the GTT or GTA entries that were removed or changed in steps 4 or 6.
10. Assign the loopset specified in step 7 to the GTT or GTA entries that were removed or changed in steps 4 or 6.

If the EGTT feature is not on, perform one of these procedures:

- [Adding a Global Title Translation](#) procedure if the GTT entry was removed from the database in step 6.
- [Changing a Global Title Translation](#) procedure if the GTT entry was changed in step 6.

If the EGTT is on, perform one of these procedures:

- [Adding Global Title Address Information](#) procedure if the GTA entry was removed from the database in step 4.
- [Changing a GTT Selector](#) procedure if the GTA entry was changed in step 4.

Figure 2-174 Remove a Loopset - Sheet 1 of 3

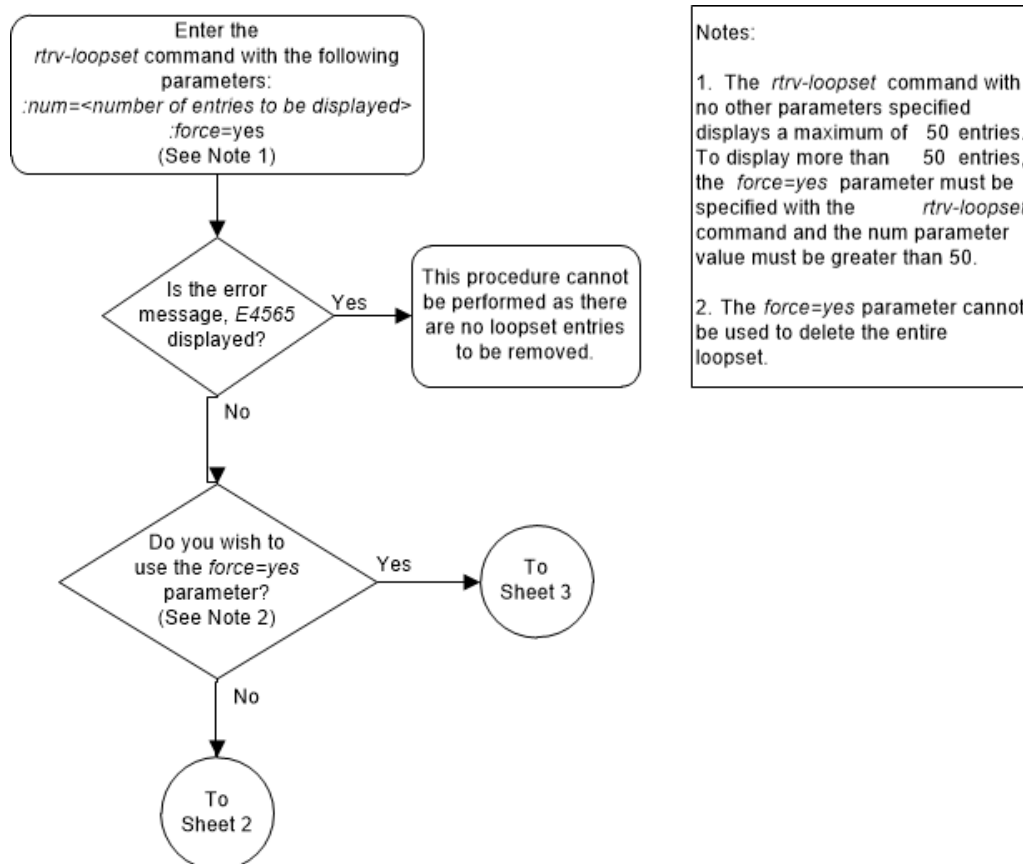

Figure 2-175 Remove a Loopset - Sheet 2 of 3

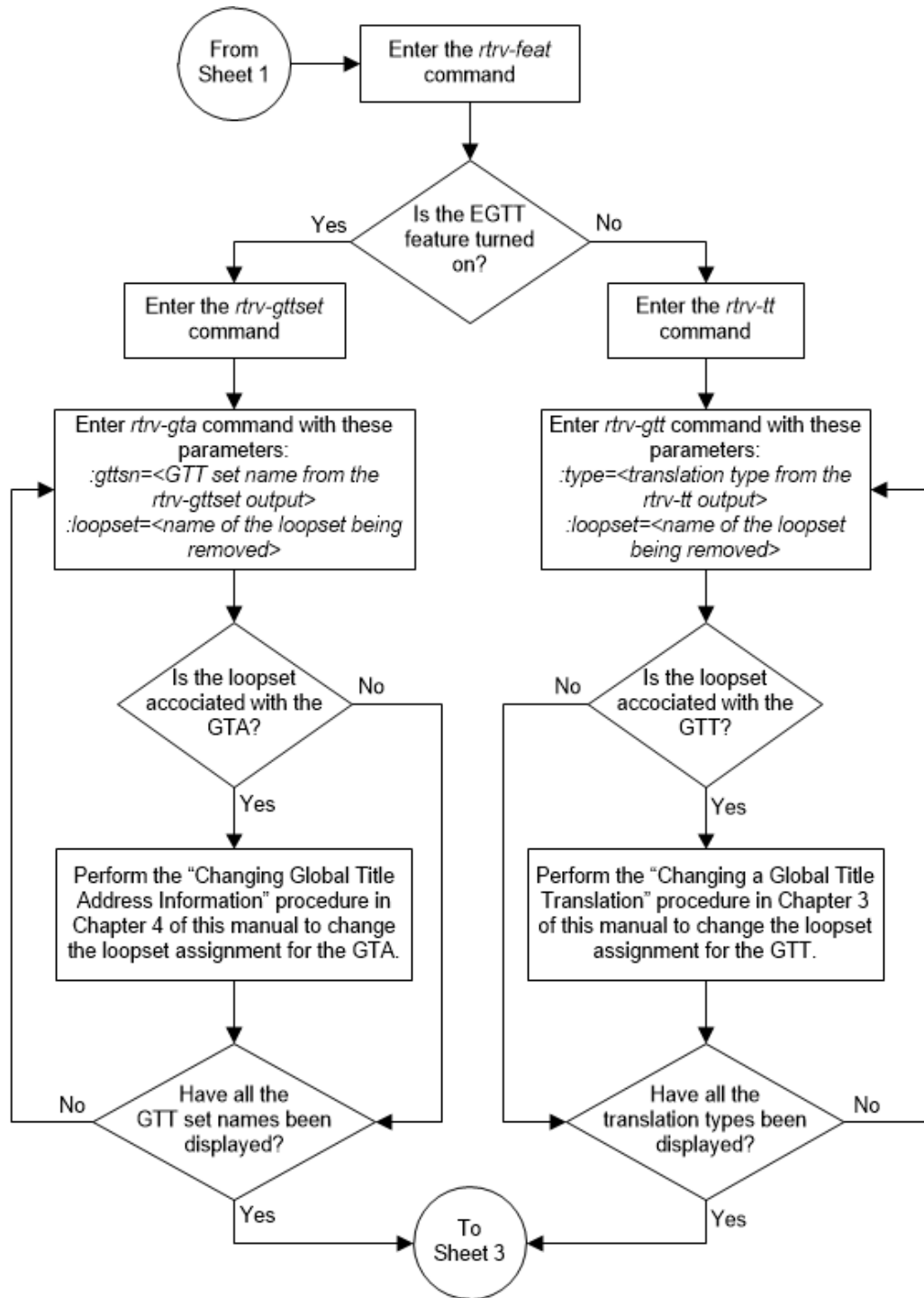
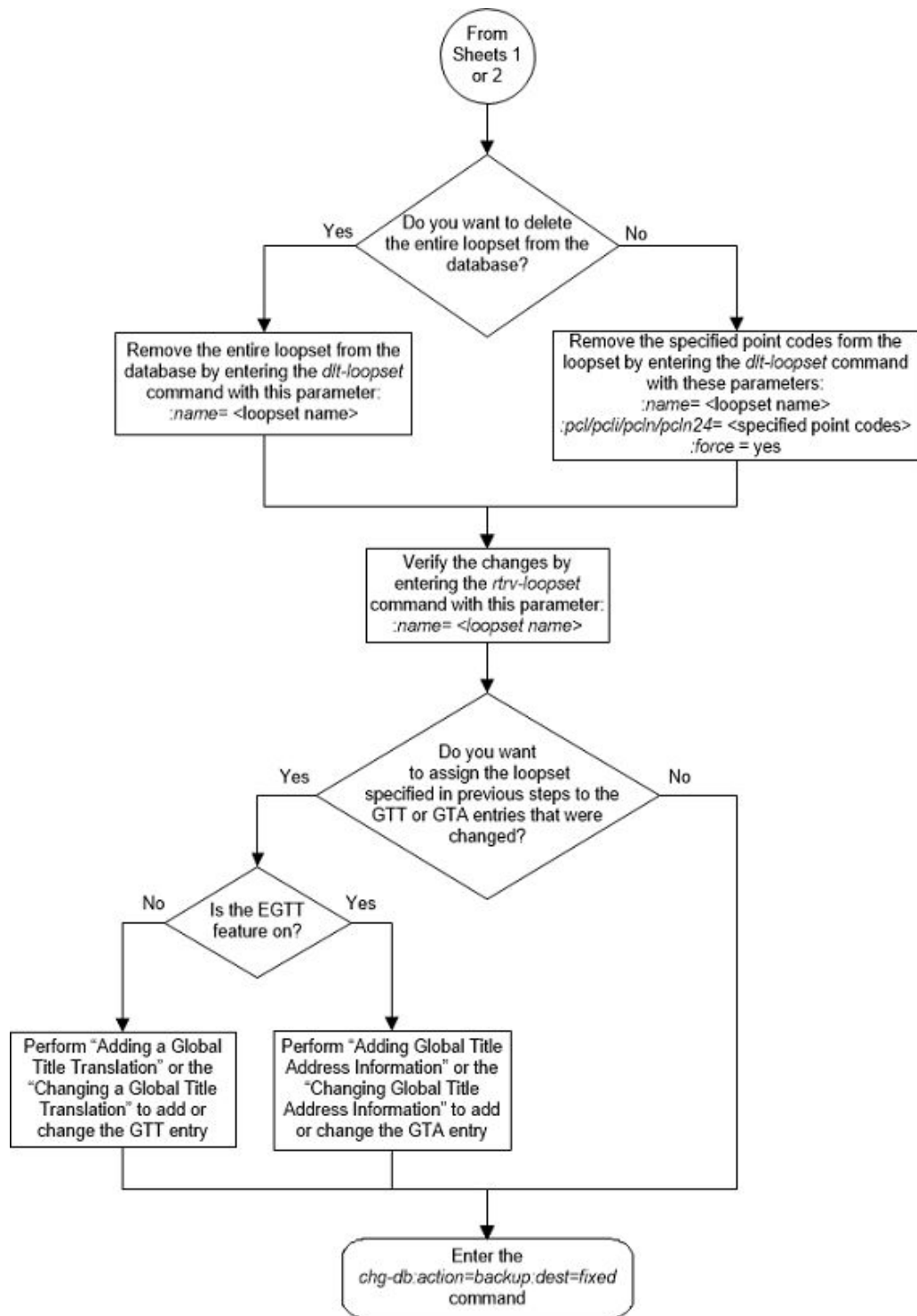

Figure 2-176 Remove a Loopset - Sheet 3 of 3



Changing the Attributes of a Loopset

This procedure is used to modify a loopset in the following ways using the `chg-loopset` command.

- Change the mode of operation
- Replace all the point codes
- Replace a specific point code
- Replace two specific point codes
- Append additional point codes

The `chg-loopset` command uses these parameters.

`:name` – The name of the loopset to be modified, shown in the `rtrv-loopset` output.

`:force` – This parameter has two values, yes or no. The value yes allows the attributes of a loopset to be changed if the loopset is assigned to entries in either the `rtrv-gtt` or `rtrv-gta` outputs. The value no requires that references to the loopset must be removed from the GTT or GTA entries before the attributes of the loopset are changed. Perform one of these procedures to remove a reference to the loopset, depending on whether or not the EGTT feature is on. The status of the EGTT feature is shown in the `rtrv-feat` command output.

- If the EGTT feature is not on – Enter the `rtrv-gtt` command to verify the loopset references. Perform the [Changing a Global Title Translation](#) procedure and change the loopset reference to `NONE` or to another loopset name, or remove the global title translation by performing the [Removing a Global Title Translation](#) procedure.
- If the EGTT feature is on – Enter the `rtrv-gta` command to verify the loopset references. Perform [Changing Global Title Address Information](#) and change the loopset reference to `NONE` or to another loopset name, or remove the entry by performing the [Removing Global Title Address Information](#) procedure.

`:pcl/pcla/pcli/pcln/pcln24` – The point code, either an ANSI point code (`pcl/pcla`), ITU-I or ITU-I spare point code (`pcli`), a 14-bit ITU-N or 14-bit ITU-N spare point code (`pc1n`), or a 24-bit ITU-N (`pc1n24`) point code, assigned to the loopset shown in the `rtrv-loopset` output that is to be replaced by a new point code. This point code is the first or the only point code that can be replaced when the `chg-loopset` command is used to replace two specific point codes or a single point code.

`:pc2/pc2a/pc2i/pc2n/pc2n24` – The point code, either an ANSI point code (`pc2/pc2a`), ITU-I or ITU-I spare point code (`pc2i`), a 14-bit ITU-N or 14-bit ITU-N spare point code (`pc2n`), or a 24-bit ITU-N (`pc2n24`) point code, assigned to the loopset shown in the `rtrv-loopset` output that is to be replaced by a new point code. This point code is the second point code that can be replaced when the `chg-loopset` command is used to replace two specific point codes.

`:rpcl/rpcla/rpcli/rpcln/rpcln24` – The point code, either an ANSI point code (`rpcl/rpcla`), ITU-I or ITU-I spare point code (`rpcli`), a 14-bit ITU-N or 14-bit ITU-N spare point code (`rpcln`), or a 24-bit ITU-N (`rpcln24`) point code, that is used to simultaneously replace all the point code(s) assigned to the loopset shown in the `rtrv-loopset` output.

`:npcl/npcla/npcli/npcln/npcln24` – The point code, either an ANSI point code (`npcl/npcla`), ITU-I or ITU-I spare point code (`npcli`), a 14-bit ITU-N or 14-bit ITU-N spare point code (`npcln`), or a 24-bit ITU-N (`npcln24`) point code that replaces the first or the only specified point code when the `chg-loopset` command is used to replace two specific point codes or a single point code.

:npc2/npc2a/npc2i/npc2n/npc2n24 – The point code, either an ANSI point code (npc2/npc2a), ITU-I or ITU-I spare point code (npc2i), a 14-bit ITU-N or 14-bit ITU-N spare point code (npc2n), or a 24-bit ITU-N (npc2n24) point code that replaces the second specified point code when the `chg-loopset` command is used to replace two specific point codes.

:apcl/apcla/apcli/apcln/apcln24 – The point code, either an ANSI point code (apcl/apcla), ITU-I or ITU-I spare point code (apcli), a 14-bit ITU-N or 14-bit ITU-N spare point code (apcln), or a 24-bit ITU-N (apcln24) point code that can be appended to the set of point codes assigned to the loopset shown in the `rtrv-loopset` output.

:mode – The mode of operation of the SCCP Loop Detection feature. This parameter can have either of the two values Notify and Discard.

1. Display the loopsets in the database by entering this command. This is an example of the possible output

```
rtrv-loopset:num=1000:force=yes
```

 **Note:**

>If the `rtrv-loopset` command is entered with no other parameters specified, a maximum of 50 entries are displayed. To display more than 50 entries, the `force=yes` parameter must be specified with the `rtrv-loopset` command and the `num` parameter value must be greater than 50. Since there can be a maximum of 1000 loopsets in the database, to display all the loopsets in the database, the `force=yes` and `num=1000` parameters must be specified with the `rtrv-loopset` command.

This is an example of the possible output.

```
rlghncxa03w 06-10-18 08:52:38 GMT EAGLE Rel 35.6.0
LoopSet  Mode      Point Codes
=====
=====
rtp1      notify  005-005-005      007-007-007      (ANSI)
           003-004-003      003-007-003
           005-007-005      007-004-007
           005-004-005

rtp2      notify  002-002-002      003-003-003      (ANSI)
           004-004-004      005-005-005

LOOPSET table is (2 of 1000) 1% full
```

If error message E4565 is displayed or if no loopsets are displayed, this procedure cannot be performed.

 **Note:**

If the `force=yes` parameter will be specified with the `chg-loopset` command, a loopset can be changed without changing or deleting the association, if any, of the loopset with a GTT or a GTA. Skip steps 2 through 6 and go to step 7.

2. Verify whether or not the EGTT feature is turned on by entering the `rtrv-feat` command. If the EGTT featured is turned on, the EGTT field should be set to on.

 **Note:**

The `rtrv-feat` command output contains other fields that are not used by this procedure. If you wish to know about all the fields displayed by the `rtrv-feat` command, refer to the `rtrv-feat` command description in *Commands User's Guide*.

 **Note:**

If the EGTT feature is not turned on, skip step 3 and step 4 and go to step 5.

3. Display the GTT sets in the database using the `rtrv-gttset` command. This is an example of the possible output.

```
rlghncxa03w 09-07-07 00:27:31 GMT EAGLE5 41.1.0
```

GTTSN	NETDOM	SETTYPE	NDGT
setans015	ansi	CDGTA	6
set1	ansi	CDGTA	6

```
GTT-SET table is (2 of 2000) 1% full.
```

4. Display the global title address (GTA) information for a GTT set from step 3. Execute the `rtrv-gta` command with the `gttsn` parameter value shown in the output of step 3 and with the name of the loopset being changed, specified with the `loopset` parameter. For this example, enter this command.

```
rtrv-gta:gttsn=set1:loopset=rtp1
```

This is an example of the possible output.

```
rlghncxa03w 09-05-07 00:27:31 GMT EAGLE5 41.0.0
```

GTTSN	NETDOM	SETTYPE	NDGT
set1	ansi	CDGTA	6

```
GTT TABLE IS 1 % FULL (2 of 269999)
```

START GTA	END GTA	XLAT	RI	PCA
919460	919460	DISC		

```

919461    919461    DPC    SSN    002-002-002
          SSN=--- CCGT=no NTT=---
          LOOPSET = rtpl    FALLBACK=sysdflt TESTMODE=off
          OPTSN=----- CGSELID=---- CDSELID=----- OPCS=-----

```

Command Retrieved 2 Entries

If any of the displayed entries reference the loopset being modified, for those entries, perform [Changing Global Title Address Information](#) and change the loopset reference to `NONE` or to another loopset name, or remove the entry by performing the [Removing Global Title Address Information](#) procedure.

If the displayed entries do not reference the loopset being removed, repeat this step with the other GTT set names displayed in step 3.

When all the GTT set names have been displayed and all applicable global title translation entries have been changed or removed in this step, go to step 7.

5. Display the translation types in the database using the `rtrv-tt` command.

This is an example of the possible output.

```

rlghncxa03w 07-03-25 09:42:31 GMT EAGLE5 35.6.0
TYPEA      TTN      NDGT
1          lidb     5
2          c800    10
3          d700    6
5          scp1   6
10         scp2   6
15         scp3   3

ALIAS      TYPEA
30         5
40         10
50         3
65         3

TYPEI      TTN      NDGT
105       itudb   8

ALIAS      TYPEI
7         105

TYPEN      TTN      NDGT
120       dbitu   7

ALIAS      TYPEN
8         120

```

6. Display the global title translations in the database using the `rtrv-gtt` command specifying a translation type from the `rtrv-tt` command output shown in step 5 and with the name of the loopset being removed, specified with the `loopset` parameter. For this example, enter this command.

```
rtrv-gtt:typea=10:loopset=rtpl
```

This is an example of the possible output.

```
rlghncxa03w 08-10-25 09:43:31 GMT EAGLE5 39.2.0
TYPEA TTN      NDGT
10     scp2    6

GTT TABLE IS 10 % FULL (27000 of 269999)

START GTA          END GTA          XLAT  RI      PC
615370            615380          DPCSSN SSN
003-003-003
      MAPSET=6      SSN=254 NGT=---
      LOOPSET = rtp1
```

Command Retrieved 1 Entries

If any of the displayed entries reference the loopset being modified, for those entries, perform the [Changing a Global Title Translation](#) procedure and change the loopset reference to `NONE` or to another loopset name, or remove the global title translation by performing the [Removing a Global Title Translation](#) procedure.

If the displayed entries do not reference the loopset being removed, repeat this step with the other translation types displayed in step 5.

When all the translation types have been displayed and all applicable global title translation entries have been changed or removed in this step, go to step 7.

7. If all the point codes of the loopset are being replaced simultaneously, specify the `chg-loopset` command with the name of the loopset with the `rpc1` parameter.

For this example, enter this command to replace all the point codes of the loopset simultaneously.

```
chg-
loopset:name=rtp1:rpc1a=003-003-003,001-001-001,002-002-002
```

This message should appear.

```
rlghncxa03w 07-02-19 10:37:19 GMT 35.6.0
LOOPSET table is (1 of 1000) 1% full
CHG-LOOPSET: MASP A - COMPLTD
```

If a single specified point code value is to be modified in the loopset, specify the `chg-loopset` command with the name of the loopset, the point code you wish to change and the new point code.

For this example, enter this command to modify a single point code in the loopset.

```
chg-loopset:name=rtp1:pc1=003-003-003:npc1=003-004-005
```

This message should appear.

```
rlghncxa03w 07-02-19 10:50:36 GMT 35.6.0
LOOPSET table is (1 of 1000) 1% full
CHG-LOOPSET: MASP A - COMPLTD
```

If two specified point code values are to be modified in the loopset, specify the `chg-loopset` command with the name of the loopset, the two point codes you wish to change and the new point codes.

For this example, enter this command to modify two specific point codes in the loopset.

```
chg-  
loopset:name=rtp1:pc1=003-004-005:npc1=003-004-007:pc2=001-001-001:npc2=001-003-004
```

This message should appear.

```
rlghncxa03w 07-02-19 10:59:08 GMT 35.6.0  
LOOPSET table is (1 of 1000) 1% full  
CHG-LOOPSET: MASP A - COMPLTD
```

If only the `mode` parameter is to be modified in the loopset, specify the `chg-loopset` command with the name of the loopset, the new value of the `mode` parameter.

For this example, enter this command to modify two specific point codes in the loopset.

```
chg-loopset:name=rtp1:mode=discard
```

This message should appear.

```
rlghncxa03w 07-02-19 11:04:52 GMT 35.6.0  
LOOPSET table is (1 of 1000) 1% full  
CHG-LOOPSET: MASP A - COMPLTD
```

If point codes are to be appended in the loopset, specify the `chg-loopset` command with the name of the loopset, the point codes to be appended.

For this example, enter this command to append the point codes to the loopset.

```
chg-loopset:name=rtp1:apcla=7-7-7,3-3-3,5-5-5
```

```
rlghncxa03w 07-02-19 11:19:26 GMT 35.6.0  
LOOPSET table is (1 of 1000) 1% full  
CHG-LOOPSET: MASP A - COMPLTD
```

Refer to the following table for the `chg-loopset` parameter combinations.

Table 2-60 Changing a Loopset Parameter Combinations

Changing Mode only	Replacing All Point Codes	Replacing One Specific Point Code	Replacing two Specific Point Codes	Appending Point Codes
Mandatory Parameters				
Name (See Note 1)	Name (See Note 1)	Name (See Note 1)	Name (See Note 1)	Name (See Note 1)

Table 2-60 (Cont.) Changing a Loopset Parameter Combinations

Changing Mode only	Replacing All Point Codes	Replacing One Specific Point Code	Replacing two Specific Point Codes	Appending Point Codes
Mode	RPCL/RPCLA/ RPCLI/RPCLN/ RPCLN24	PC1/PC1A/ PC1I/PC1N/ PC1N24 NPC1/NPC1A/ NPC1I/NPC1N/ NPC1N24	PC1/PC1A/ PC1I/PC1N/ PC1N24 NPC1/NPC1A/ NPC1I/NPC1N/ NPC1N24 PC1/PC1A/ PC1I/PC1N/ PC1N24 NPC2/NPC2A/ NPC2I/NPC2N/ NPC2N24	APCL/APCLA/ APCLI/APCLN/ APCLN24
Optional Parameters				
Force=yes	Mode Force=yes	Mode Force=yes	Mode Force=yes	Mode Force=yes

Parameter Values:

Name – Loopset name

Mode – Mode of operation

APCL/APCLA/APCLI/APCLN/APCLN24 – Appending point code list

RPCL/RPCLA/RPCLI/RPCLN/RPCLN24 – Replacing point code List

PC1/PC1A/PC1I/PC1N/PC1N24 – Point code to be replaced first

PC2/PC2A/PC2I/PC2N/PC2N24– Point code to be replaced after the replacement of the first point code when two specific point codes are replaced

NPC1/NPC1A/NPC1I/NPC1N/NPC1N24– Point code that replaces the first specified point code or the only point code when two specific point codes or a single specified point code is replaced

NPC2/NPC2a/NPC2I/NPC2N/NPC2N24– Point code that replaces the second specified point code when two specific point codes are replaced

FORCE – yes, no. Default = no

Notes:

- a. The `name` parameter can take up to 8 alphanumeric characters. The first character must be an alphabetic character.
- b. The `rpcl` parameter allows the replacement of a maximum of six point code in a loopset.
- c. The `apcl` parameter allows a maximum of six point codes to be appended to a loopset per execution of the `chg-loopset` command. A maximum of 12 point codes can be appended to any loopset using the `apcl` parameter.

 **Note:**

If the loopset being modified in this step is referenced by an entry shown in either the `rtrv-gtt` or `rtrv-gta` outputs, and those entries have not been removed or the loopset assignment for these entries has not been changed, the `force=yes` parameter must be specified with the `chg-loopset` command.

- Verify the changes using the `rtrv-loopset` command with the name of the loopset specified in step 7.

In this example enter this command.

```
rtrv-loopset:name=rtpl
```

The following message should appear if you have replaced all the point codes in step 7.

```
rlghncxa03w 07-02-19 19:42:34 GMT 35.6.0
LoopSet      Mode      Point Codes
=====
=====
rtpl         discard    003-003-003      002-002-002      (ANSI)
                                001-001-001
```

The following message should appear if you have modified a single specific point code in step 7.

```
rlghncxa03w 07-02-19 19:49:47 GMT 35.6.0
LoopSet      Mode      Point Codes
=====
=====
rtpl         discard    003-004-005      002-002-002      (ANSI)
                                001-001-001
```

The following message should appear if you have modified two specific point codes in step 7.

```
rlghncxa03w 07-02-19 19:56:57 GMT 35.6.0
LoopSet      Mode      Point Codes
=====
=====
rtpl         discard    003-004-007      002-002-002      (ANSI)
                                001-003-004
```

The following message should appear if you have appended point codes in step 7.

```
rlghncxa03w 07-02-19 20:03:21 GMT 35.6.0
LoopSet      Mode      Point Codes
=====
=====
rtpl         discard    003-004-007      002-002-002      (ANSI)
```

```
001-003-004      007-007-007
003-003-003      005-005-005
```

The following message should appear if you have only changed the mode in step 7.

```
rlghncxa03w 07-02-19 20:09:00 GMT 35.6.0
LoopSet      Mode      Point Codes
=====
=====
rtp1         notify      003-003-003      002-002-002      (ANSI)
                                001-001-001
```

9. Backup the new changes using the `chg-db:action=backup:dest=fixed` commend. These messages should appear, the active Maintenance and Administration Subsystem Processor (MASP) appears first.

```
BACKUP (FIXED) : MASP A - Backup starts on active MASP.
BACKUP (FIXED) : MASP A - Backup on active MASP to fixed disk
complete.
BACKUP (FIXED) : MASP A - Backup starts on standby MASP.
BACKUP (FIXED) : MASP A - Backup on standby MASP to fixed disk
complete.
```

If a loopset was changed in step 7 and the `force=yes` was not used in step 7, and you wish to assign this loopset to the GTT or GTA entries that were removed or changed in steps 4 or 6, go to step 10.

If any of the following actions were performed in step 7, this procedure is finished. Do not perform step 10.

- A loopset was modified with the `force=yes` parameter in step 7.
 - A loopset was modified in step 7, the `force=yes` was not used in step 7, and you do not wish to assign this loopset to the GTT or GTA entries that were removed or changed in steps 4 or 6.
10. Assign the loopset specified in step 7 to the GTT or GTA entries that were removed or changed in steps 4 or 6.

If the EGTT feature is not on, perform one of these procedures:

- [Adding a Global Title Translation](#) procedure if the GTT entry was removed from the database in step 6.
- [Changing a Global Title Translation](#) procedure if the GTT entry was changed in step 6.

If the EGTT is on, perform one of these procedures:

- [Adding Global Title Address Information](#) procedure if the GTA entry was removed from the database in step 4.
- [Changing Global Title Address Information](#) procedure if the GTA entry was changed in step 4.

Figure 2-177 Change the Attributes of a Loopset - Sheet 1 of 3

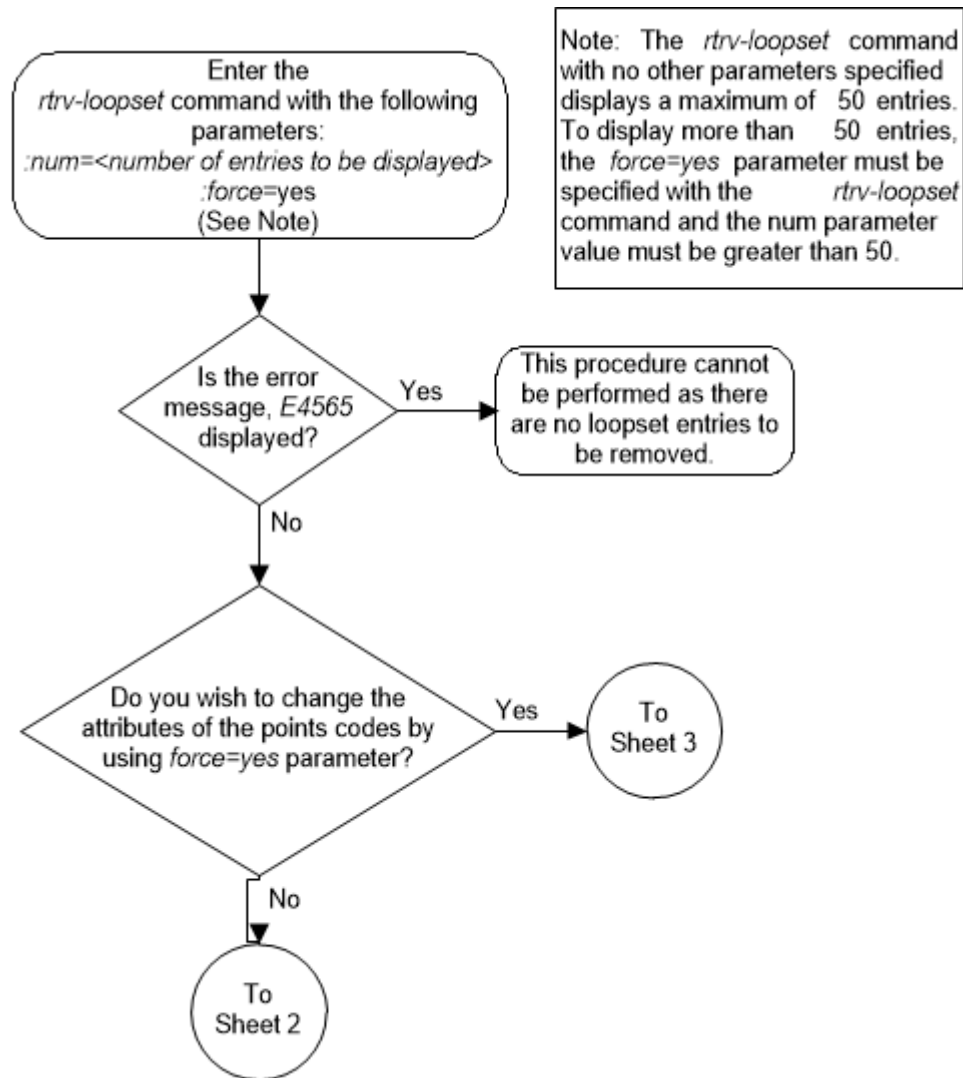

Figure 2-178 Change the Attributes of a Loopset - Sheet 2 of 3

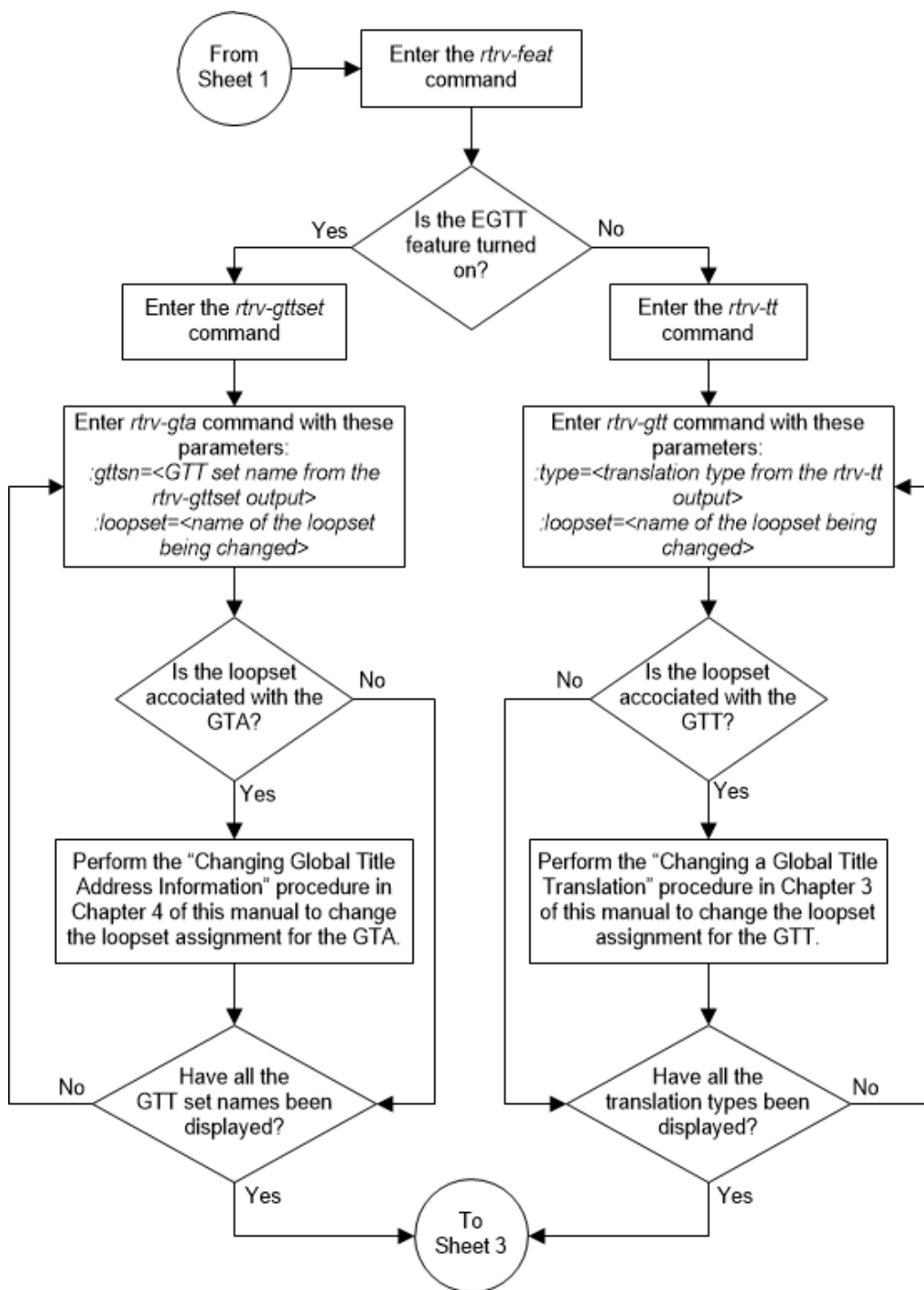
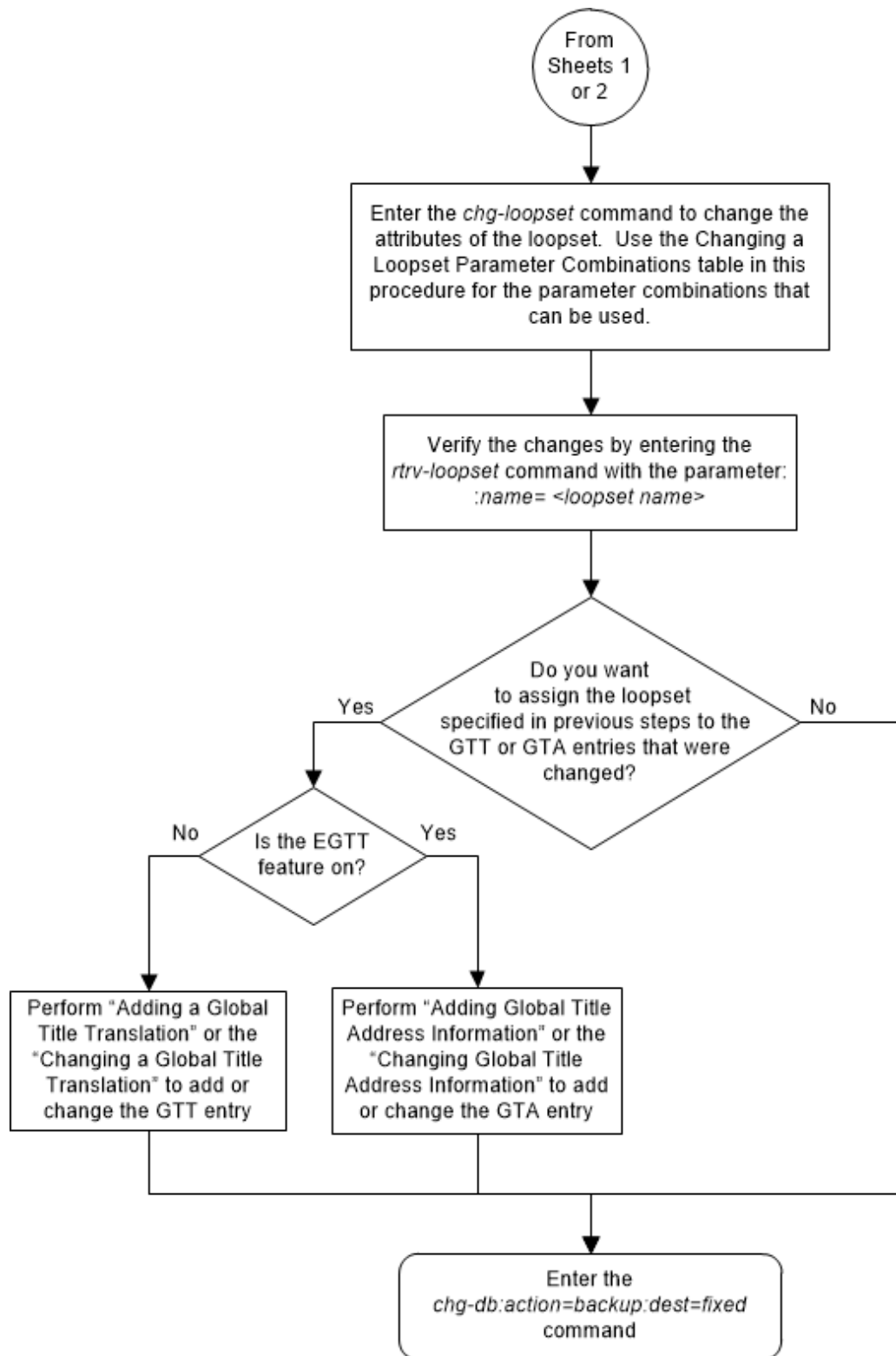

Figure 2-179 Change the Attributes of a Loopset - Sheet 3 of 3



Configuring the ANSI to ITU-N SCCP Conversion Option

This procedure is used to set the value of the called party/calling party address Reserved for National Use bit that is used during SCCP conversion when global title translation routes the message to the ITU national network. The called/calling party address Reserved for National Use bit is set using the `chg-sccpopts` command and with this parameter.

`:cnvainat` – the value of the called party/calling party address Reserved for National Use bit used during SCCP conversion when the MSU is routed to the ITU national network. The values for this parameter are:

- 0 – the Reserved for National Use bit is not reserved for national use.
- 1 – the Reserved for National Use bit is reserved for national use.

The system default value for this parameter is 1.

The ANSI/ITU SCCP Conversion feature must be enabled and turned on to change this parameter value with the `chg-sccpopts` command. The `CNVAINAT` field in the output of the `rtrv-sccpopts` command output is shown when the ANSI/ITU SCCP Conversion feature is enabled and turned on. If the `CNVAINAT` field is not shown in the output of the `rtrv-sccpopts` command output, perform the [Activating the ANSI/ITU SCCP Conversion Feature](#) procedure to enable the ANSI/ITU SCCP Conversion feature.

If any parameter is not specified with the `chg-sccpopts` command, that parameter value will not be changed.

For more information on the ANSI/ITU SCCP Conversion feature, refer to the [ANSI/ITU SCCP Conversion Feature](#) section.

1. Display the existing value for the `cnvainat` parameter value by entering `rtrv-sccpopts` command. This is an example of the possible output.

```
rlghncxa03w 08-05-17 16:02:05 GMT EAGLE5 38.0.0
SCCP OPTIONS
-----
CNVAINAT                               1
```

Note:

>The `rtrv-sccpopts` command output contains other fields that are not used by this procedure. If you wish to see all the fields displayed by the `rtrv-sccpopts` command, refer to the `rtrv-sccpopts` command description in *Commands User's Guide*.

If the `CNVAINAT` field is not shown in the output of the `rtrv-sccpopts` command, the ANSI/ITU SCCP Conversion feature is not enabled and turned on. For this field to be shown in the `rtrv-sccpopts` output, and to change these values, the ANSI/ITU SCCP Conversion feature must be enabled and turned on. Perform the [Activating the ANSI/ITU SCCP Conversion Feature](#) procedure to

enable and turn on the ANSI/ITU SCCP Conversion feature. After the ANSI/ITU SCCP Conversion has been enabled and turned on, continue the procedure with 2

If the CNVAINAT field is shown in the `rtrv-sccpopts` output, continue the procedure with 2.

2. Change the `cnvainat` parameter value by entering the `chg-sccpopts` command with the `cnvainat` parameters. For this example, enter this command.

```
chg-sccpopts:cnvainat=0
```

If any parameter is not specified with the `chg-sccpopts` command, that parameter value will not be changed.

When the `chg-sccpopts` command has successfully completed, this message should appear.

```
rlghncxa03w 08-05-07 00:22:57 GMT EAGLE5 38.0.0
CHG-SCCPOPTS: MASP A - COMPLTD
```

3. Verify the changes using the `rtrv-sccpopts` command. This is an example of the possible output.

```
rlghncxa03w 08-05-17 16:02:05 GMT EAGLE5 38.0.0

SCCP OPTIONS
-----
CNVAINAT                                0
```

 **Note:**

>The `rtrv-sccpopts` command output contains other fields that are not used by this procedure. If you wish to see all the fields displayed by the `rtrv-sccpopts` command, refer to the `rtrv-sccpopts` command description in *Commands User's Guide*.

4. Back up the new changes using the `chg-db:action=backup:dest=fixed` command. These messages should appear, the active Maintenance and Administration Subsystem Processor (MASP) appears first.

```
BACKUP (FIXED) : MASP A - Backup starts on active MASP.
BACKUP (FIXED) : MASP A - Backup on active MASP to fixed disk
complete.
BACKUP (FIXED) : MASP A - Backup starts on standby MASP.
BACKUP (FIXED) : MASP A - Backup on standby MASP to fixed disk
complete.
```

Figure 2-180 Configure the ANSI to ITU-N SCCP Conversion Option

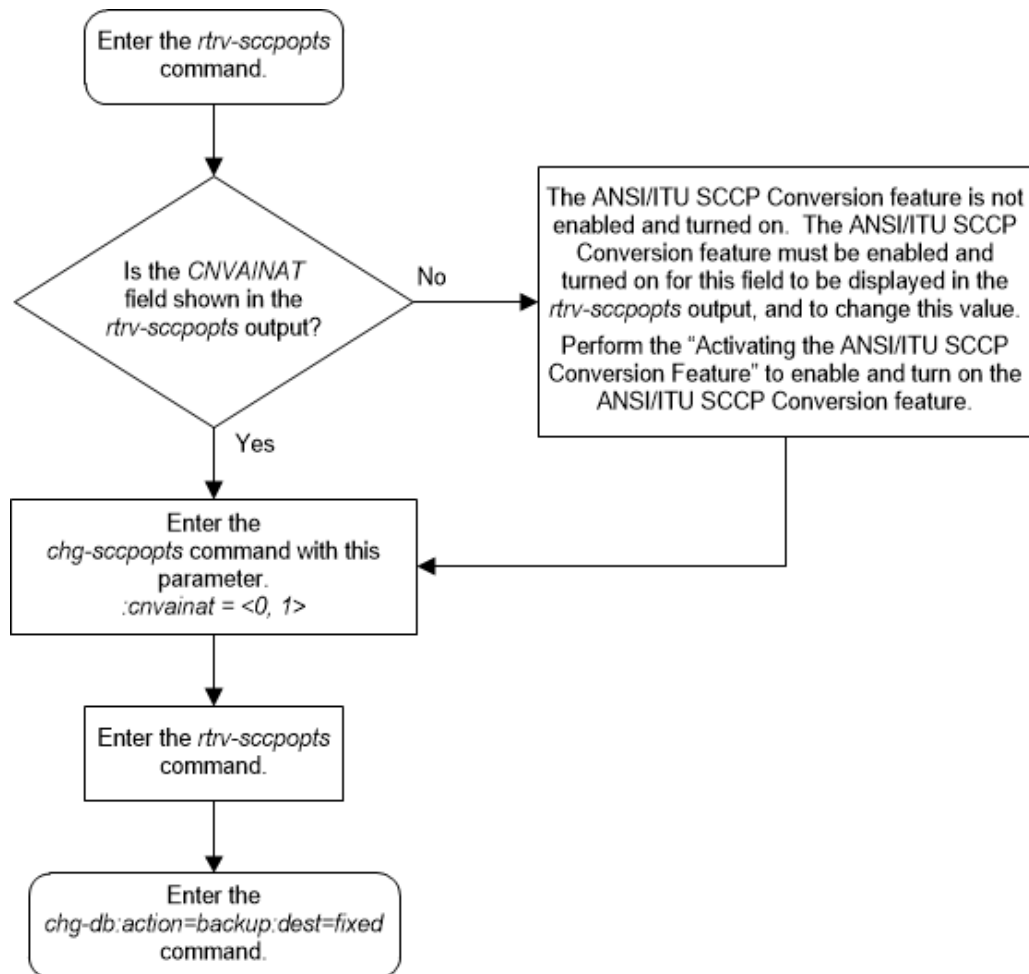

Configuring a SCCP Test Message

A SCCP test message is used to supply the data needed by the `tst-msg` command to debug the global title translation rules for these features.

- Origin-Based SCCP Routing
- Flexible Linkset Optional Based Routing
- TCAP Opcode Based Routing

The data for an SCCP test message is configured using the `chg-sccp-msg` command. [Table 2-61](#) shows the parameters and their combinations that are used with the `chg-sccp-msg` command.

To perform this procedure, the GTT feature must be turned on. This can be verified by entering the `rtrv-feat` command. If the `gtt` value is `on`, the GTT feature is on. If the GTT feature is not on, perform the [Adding a Service Module](#) procedure to turn the GTT feature on and make sure the correct hardware is installed and provisioned.

If any parameter is not specified with the `chg-sccp-msg` command, that parameter value will not be changed.

Table 2-61 SCCP Test Message Parameter Combinations

Flexible Linkset Optional Based Routing Enable and Turned On and TCAP Opcode Based Routing feature Enable and Turned On	
Mandatory Parameter	
:msgn - 1 to 10	
Optional Parameters (See Note 1)	
:active - specifies whether the SCCP message should be sent to the network card for processing - yes, no. Default value - yes	
:cdgta - the called party address for the SCCP message - 1 - 21 digits or 1 - 21 hexadecimal digits. Default value - 1234567890	
:cdgti - the called party global title indicator for the SCCP message - 2 or 4. Default value - 2 (See Note 2)	
:cdnai - the called party nature of address indicator for the SCCP message - See Note 3. Default value - sub	
:cdnaiv - the called party nature of address indicator value for the SCCP message - See Note 3. Default value - 1	
:cdnp - the called party numbering plan for the SCCP message - See Note 4. Default value - e164	
:cdnpv - the called party numbering plan value for the SCCP message - See Note 4. Default value - 1	
:cdpc/cdpci/cdpcn/cdpcn24 - the called party address point code. Default value - ANSI point code 010-010-010 (See Note 5)	
:cdssn - the called party subsystem number for the SCCP message - 0 - 255, none. Default value - 6	
:cdtt - the called party translation type for the SCCP message - 0 - 255. Default value - 0	
:cggta - the calling party address for the SCCP message - 1 - 21 digits or 1 - 21 hexadecimal digits. Default value - 1234567890	
:cggti - the calling party global title indicator for the SCCP message - 2 or 4. Default value - 2 (See Note 2)	
:cgnai - the calling party nature of address indicator for the SCCP message - See Note 6. Default value - sub	
:cgnaiv - the calling party nature of address indicator value for the SCCP message - See Note 6. Default value - 1	
:cgnp - the calling party numbering plan for the SCCP message - See Note 7. Default value - e164	
:cgnpv - the calling party numbering plan value for the SCCP message - See Note 7. Default value - 1	
:cgpc/cgpci/cgpcn/cgpcn24 - the calling party address point code. Default value - ANSI point code 020-020-020 (See Note 5)	
:cgssn - the calling party subsystem number for the SCCP message - 0 - 255, none. Default value - 8	
:cgtt - the calling party translation type for the SCCP message - 0 - 255. Default value - 0	
:eaglegen - specifies whether the message is an EAGLE generated message - no, yes. Default value - no	
:lsn - the name of the incoming linkset for the SCCP message. The linkset must be shown in the <code>rtrv-ls</code> output. Default value - No lsn value specified	
:opc/opci/opcn/opcn24 - the originating point code. Default value - ANSI point code 010-010-010 (See Note 5)	

Table 2-61 (Cont.) SCCP Test Message Parameter Combinations

Flexible Linkset Optional Based Routing Enable and Turned On and TCAP Opcode Based Routing feature Enable and Turned On

:tcapacn - a maximum of 7 subfields containing the numbers 0 to 255 separated by dash (for example, 1-202-33-104-54-26-007), none. The value none means there is no ITU TCAP ACN field in the incoming message. Default value - none

:tcapfamily - 0 - 255, none. The value none means there is no ANSI TCAP FAMILY field in the incoming message. Default value - none

:tcapopcode - 0 - 255, none. The value none means there is no TCAP OPCODE field in the incoming message. Default value - none

:tcappkg - See Notes 8 and 9. Default value - invalid

:tcappkgv - 0 - 255. Default value - 0 (See Note 8)

:dpc/dpca/dpci/dpcn/dpcn24 - the destination point code. Default value - ANSI point code 020-020-020 (See Note 5)

:selid - 0 - 65534 - Default value - no value specified

Table 2-61 (Cont.) SCCP Test Message Parameter Combinations**Flexible Linkset Optional Based Routing Enable and Turned On and TCAP Opcode Based Routing feature Enable and Turned On****Notes:**

1. At least one optional parameter must be specified.
2. The `cdgti` and `cggti` parameter value must be 2 for an ANSI SCCP test message.
3. The values for the `cdnai` and `cdnaiv` parameters and the mapping between these parameters are shown in the [Table 2-62](#). Either the `cdnai` and `cdnaiv` parameters can be specified, but both parameters cannot be specified at the same time.
4. The values for the `cdnp` and `cdnpv` parameters and the mapping between these parameters are shown in the [Table 2-63](#). Either the `cdnp` and `cdnpv` parameters can be specified, but both parameters cannot be specified at the same time.
5. The point code values for the `cdpc/cdpci/cdpcn/cdpcn24`, `cgpc/cgpci/cgpcn/cgpcn24`, `opc/opci/opcn/opcn24`, `dpc/dpca/dpci/dpcn/dpcn24` parameters are:
 - `cdpc`, `cgpc`, `opc`, `dpc/dpca` = ANSI point code
 - `cdpci`, `cgpci`, `opci`, `dpci` = ITU-I or ITU-I spare point code
 - `cdpcn`, `cgpcn`, `opcn`, `dpcn` = 14-bit ITU-N or 14-bit ITU-N spare point code
 - `cdpcn24`, `cgpcn24`, `opcn24`, `dpcn24` = 24-bit ITU-N point code.
6. The values for the `cgnai` and `cgnaiv` parameters and the mapping between these parameters are shown in the [Table 2-62](#). Either the `cgnai` and `cgnaiv` parameters can be specified, but both parameters cannot be specified at the same time.
7. The values for the `cgnp` and `cgnpv` parameters and the mapping between these parameters are shown in the [Table 2-63](#). Either the `cgnp` and `cgnpv` parameters can be specified, but both parameters cannot be specified at the same time.
8. Either the `tcappkg` and `tcappkgv` parameters can be specified, but both parameters cannot be specified at the same time.
9. The `tcappkg` values are:
 - The values for an ANSI TCAP Package type are:
 - `ansiabort` - ANSI abort
 - `ansiuni` - ANSI unidirectional
 - `any` - any ANSI TCAP package type
 - `cwp` - conversation with permission
 - `cwop` - conversation without permission
 - `qwp` - query with permission
 - `qwop` - query without permission
 - `resp` - response
 - `none` - no TCAP Package type
 - The values for an ITU TCAP Package type are:
 - `any` - any ITU TCAP package type
 - `bgn` - begin
 - `cnt` - continue
 - `end` - end
 - `ituabort` - ITU abort
 - `ituuni` - ITU unidirectional
 - `none` - no TCAP Package type

Table 2-62 NAIV/NAI Mapping

NAIV	NAI	Description
0	--	Unknown
1	Sub	Subscriber Number
2	Rsvd	Reserved for national use
3	Natl	National significant number
4	Intl	International number
5-127	--	Spare

Table 2-63 NPV/NP Mapping

NPV	NP	Description
0	--	Unknown
1	E164	ISDN/telephony numbering plan
2	Generic	Generic numbering plan
3	X121	Data numbering plan
4	F69	Telex numbering plan
5	E210	Maritime mobile numbering plan
6	E212	Land mobile numbering plan
7	E214	ISDN/mobile numbering plan
8	Private	Private network or network-specific numbering plan
9-15	--	Spare

1. Verify that the GTT feature is on, by entering the `rtrv-feat` command. If the GTT feature is on, the `GTT` field should be set to `on`. For this example, the GTT feature is off.

 **Note:**

The `rtrv-feat` command output contains other fields that are not used by this procedure. If you wish to see all the fields displayed by the `rtrv-feat` command, refer to the `rtrv-feat` command description in *Commands User's Guide*.

If the GTT feature is off, perform the [Adding a Service Module](#) procedure to turn the GTT feature on and make sure the correct hardware is installed and provisioned.

Continue the procedure by performing one of these steps.

- If the `lsn` parameter will not be specified with the `chg-sccp-msg` command, continue the procedure with [3](#).
- If the `lsn` parameter will be specified with the `chg-sccp-msg` command, continue the procedure with [2](#).

 **Note:**

It is recommended that the `lsn` parameter is specified with the `chg-sccp-msg` command. When the `tst-msg` command is performed, the linkset name is used to determine the GTT mode hierarchy.

2. Display the linksets in the database by entering the `rtrv-ls` command. This is an example of the possible output.

```
rlghncxa03w 09-05-11 13:24:48 GMT EAGLE5 41.0.0

LSN          APCA  (SS7)  L3T SLT          GWS GWS GWS
SLSCI NIS
lsn1         001-001-002  none 1  1  no  A  3  off off off
no off

LSN          APCI  (SS7)  L3T SLT          GWS GWS GWS
SLSCI NIS
lsni1        2-002-2     none 1  2  no  A  2  off off off
no off
lsni2        2-002-3     none 1  2  no  A  2  off off off
no off

LSN          APCN  (SS7)  L3T SLT          GWS GWS GWS
SLSCI NIS
lsnm1        00002      none 1  2  no  A  4  off off off
no off
lsnm2        00003      none 1  2  no  A  3  off off off
no off
```

Link set table is (5 of 1024) 1% full.

3. Display the SCCP test message that will be changed by entering the `rtrv-sccp-msg` command with the number of the SCCP test message that will be changed.

For this example, enter this command.

```
rtrv-sccp-msg:msgn=3
```

This is an example of the possible output.

```
rlghncxa03w 10-07-11 12:49:38 GMT EAGLE5 42.0.0
MSG = 3
ACTIVE = YES
OPC = 010-010-010

DPC = 020-020-020

SELID = none

CDPA_GTI = 2
```

```
CDPA_TT = 0
CDPA_SSN = 6
CDPC = 010-010-010
CDPA_NP = 1 ( e164 )
CDPN_NAI = 1 ( sub )
CDPA_GTA = 1234567890

CGPA_GTI = 2
CGPA_TT = 0
CGPA_SSN = 8
CGPC = 020-020-020
CGPA_NP = 1 ( e164 )
CGPN_NAI = 1 ( sub )
CGPA_GTA = 1234567890

LSN = LINK_SET_NOT_FOUND
EAGLEGEN = NO

TCAP_FAMILY = none

TCAP_OPCODE = none

TCAP_PACKAGE = 0 (invalid)

TCAP_ACN = none
```

4. Configure the SCCP test message by entering the `chg-sccp-msg` command. [Table 2-61](#) shows the parameter combinations and values that can be used with the `chg-sccp-msg` command. For this example, configure the SCCP test message 3 with these values.

- `:opc=003-003-003`
- `:dpc=006-006-006`
- `:selid=100`
- `:cdpc=004-004-004`
- `:cgpc=005-005-005`
- `:cdtt=5`
- `:lsn=lsn1`
- `:tcapopcode=50`
- `:tcapfamily=60`
- `:tcappkg=cwp`
- `:cdgta=919460`
- `:cggta=919461`

The command line on the terminal can contain up to 150 characters. If the parameters and values specified with the `chg-sccp-msg` command are too long to fit on the `chg-sccp-msg` command line, perform the `chg-sccp-msg` command as many times as necessary to complete adding the SCCP test message.

For this example, enter these commands.

```
chg-sccp-  
msg:msgn=3:opc=003-003-003:dpc=006-006-006:selid=100:cdpc=004  
-004-004 :pc=005-005-005:cdtt=5:lsn=lsn1
```

```
chg-sccp-  
msg:msgn=3:tcapopcode=50:tcapfamily=60:tcappkg=cwp :cdgta=919  
460:cggta=919461
```

If any parameter is not specified with the `chg-sccp-msgs` command, that parameter value will not be changed.

When the `chg-sccp-msg` command has successfully completed, this message should appear.

```
rlghncxa03w 09-05-11 13:12:07 GMT EAGLE5 41.0.0  
CHG-SCCP-MSG: MASP A - COMPLTD
```

5. Verify the changes using the `rtrv-sccp-msg` command with the message number specified with the `chg-sccp-msg` command.

For this example, enter this command.

```
rtrv-sccp-msg:msgn=3
```

This is an example of the possible output.

```
rlghncxa03w 10-07-11 13:16:10 GMT EAGLE5 42.0.0  
MSG = 3  
ACTIVE = YES  
OPC = 003-003-003  
  
DPC = 006-006-006  
  
SELID = 100  
  
CDPA_GTI = 2  
CDPA_TT = 5  
CDPA_SSN = 6  
CDPC = 004-004-004  
CDPA_NP = 1 ( e164 )  
CDPN_NAI = 1 ( sub )  
CDPA_GTA = 919460  
  
CGPA_GTI = 2  
CGPA_TT = 0  
CGPA_SSN = 8  
CGPC = 005-005-005  
CGPA_NP = 1 ( e164 )  
CGPN_NAI = 1 ( sub )  
CGPA_GTA = 919461  
  
LSN = lsn1  
EAGLEGEN = NO  
  
TCAP_FAMILY = 60  
  
TCAP_OPCODE = 50
```



```
TCAP_PACKAGE = cwp (0xE5)
```

```
TCAP_ACN = none
```

6. Back up the new changes using the `chg-db:action=backup:dest=fixed` command. These messages should appear, the active Maintenance and Administration Subsystem Processor (MASP) appears first.

```
BACKUP (FIXED) : MASP A - Backup starts on active MASP.
```

```
BACKUP (FIXED) : MASP A - Backup on active MASP to fixed disk  
complete.
```

```
BACKUP (FIXED) : MASP A - Backup starts on standby MASP.
```

```
BACKUP (FIXED) : MASP A - Backup on standby MASP to fixed disk  
complete.
```

Figure 2-181 Configure a SCCP Test Message

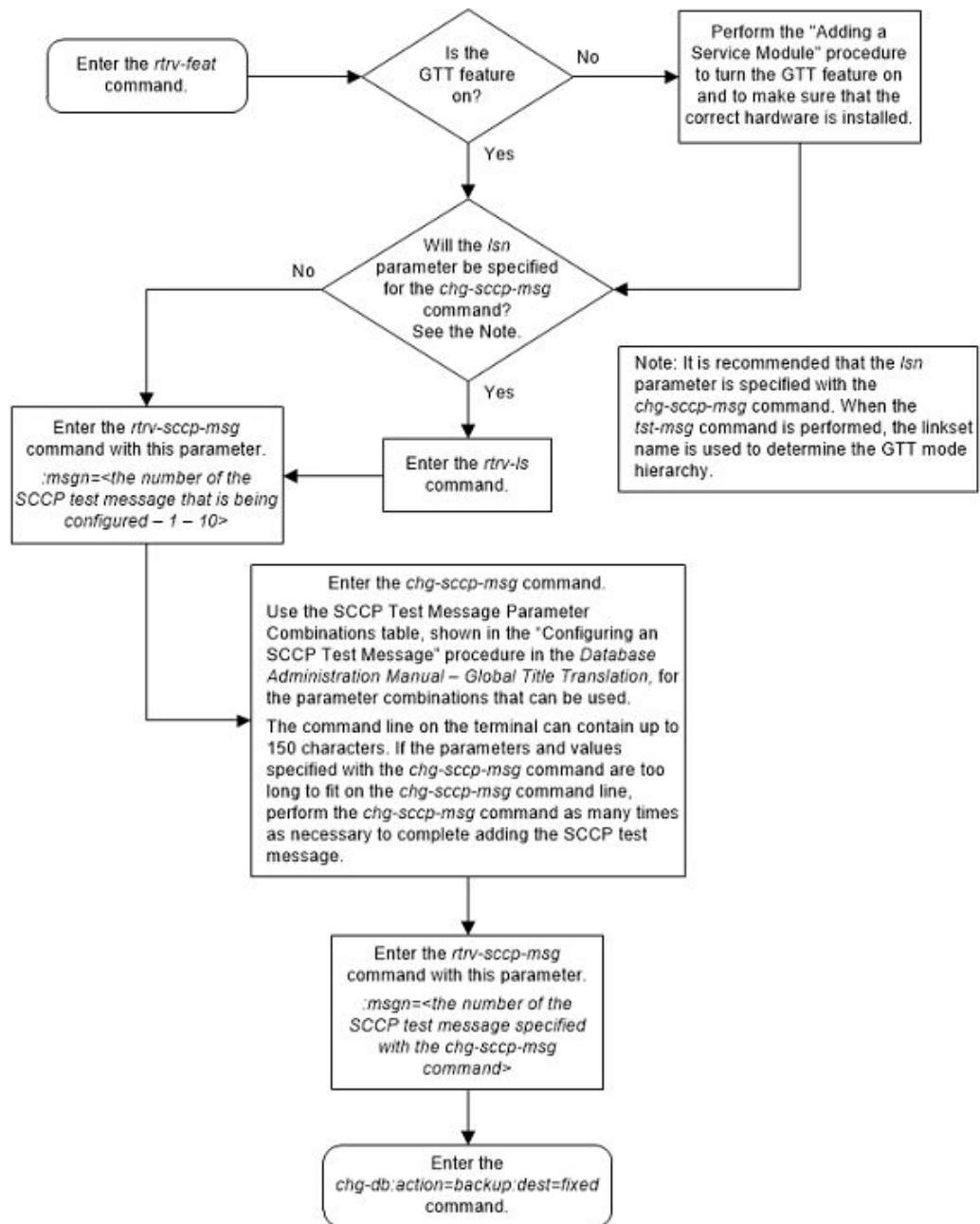

Adding Global Title Modification Information

This procedure is used to add global title (GT) modification information to the database. The GT modification information is used to modify information in an MSU during the global title translation process when the MSU requires further global title translation. The GT modification information is added to the database using the `ent-gtmod` command with these parameters.

`:gtmodid` – The name of the GT modification identifier

:cgpasnn – The subsystem number in the calling party address

:ntt – The new translation type

:nnp – The new numbering plan

:nnai – The new nature of address indicator

:npdd – The number of digits to be deleted from the beginning of the Global Title Address digits (the prefix digits)

:npds – The digits that are being substituted for the prefix digits

:nsdd – The number of digits to be deleted from the end of the Global Title Address digits (the suffix digits)

:nsds – The digits that are being substituted for the suffix digits

:ngti – The new GT indicator value

on=gt0fill - if the last value of the global title address is zero (0), it is treated or as a filler during the GT modification process.

off=gt0fill - if the last value of the global title address is zero (0), it is treated as a valid digit during the GT modification process.

precd - specifies whether the prefix (npds/npdd parameter values) or suffix (nsds/nsdd parameter values) takes precedence while modifying the received Global Title Address.

The values for these parameters and the rules for using these parameters are shown in [Table 2-64](#).

One of the Advanced GT Modification features must be enabled to add GT modification information to the database. The status of the Advanced GT Modification features is shown the `rtrv-ctrl-feat` command output. The part numbers of the Advanced GT Modification features are shown in [2](#).

1. Display the GT modification information in the database using the `rtrv-gtmod` command.

This is an example of the possible output.

```
rlghncxa03w 10-07-07 00:29:31 GMT EAGLE5 42.0.0

GTMODID   NTT   NGTI   GT0FILL   NNP   NNAI   NPDD   NSDD   PRECD   CGPASSN
modid2    --    2      ON        --    --     --     --     PFX     --
NPDS=
modid5    --    2      OFF       --    --     --     --     PFX     --
NPDS=
modid10   --    --     OFF       5     5      --     --     PFX     --
NPDS=
modid11   --    --     OFF       5     5      --     --     PFX     --
NPDS=

GTMOD table is (4 of 100000) 1% full.
```

The GT modification table can contain a maximum of 100,000 entries. If the `rtrv-gtmod` output shows 100,000 entries, a new entry cannot be added and the remainder of this procedure cannot be performed.

If the number of entries shown in the `rtrv-gtmod` output is less than 100,000 and the new GT modification entry will contain only the `gtmodid` and `ntt` parameter values, continue the procedure with 6.

If the new GT modification entry will contain other parameter values besides the `gtmodid` and `ntt` parameter values, and the number of entries shown in the `rtrv-gtmod` output is less than 100,000, continue the procedure by performing one of these steps.

 **Note:**

The GT modification entry does not have to contain an `ntt` parameter value, but must contain at least one optional parameter value. These parameter values are shown in [Table 2-64](#).

- If any of the entries shown in the `rtrv-gtmod` output contains values for parameters other than the `gtmodid` and `ntt` parameters, continue the procedure with 3.
 - If all of the entries shown in the `rtrv-gtmod` output contains only values for the `gtmodid` and `ntt` parameters, continue the procedure with 2.
2. One of the Advanced GT Modification features must be enabled to add GT modification information to the database. Enter the `rtrv-ctrl-feat` command to verify if any of the Advanced GT Modification features are enabled.

If any of the Advanced GT Modification features are enabled, one of these entries is shown in the `rtrv-ctrl-feat` output.

Feature	Part Number
AMGTT	893021801
AMGTT CdPA Only	893021802
AMGTT CgPA Upgrade	893021803

The following is an example of the possible output.

```
rlghncxa03w 10-07-28 21:15:37 GMT EAGLE5 42.0.0
The following features have been permanently enabled:
```

Feature Name	Partnum	Status	Quantity
XGTT Table Expansion	893006101	on	400000
Command Class Management	893005801	on	----
LNP Short Message Service	893006601	on	----
Intermed GTT Load Sharing	893006901	on	----
HC-MIM SLK Capacity	893012707	on	64

The following features have been temporarily enabled:

Feature Name	Partnum	Status	Quantity	Trial
Period Left				

Zero entries found.

The following features have expired temporary keys:

Feature Name	Partnum
Zero entries found.	

If none of the Advanced GT Modification features are enabled, perform the [Activating the Advanced GT Modification Feature](#) to procedure to enable any of the Advanced GT Modification features.

- Some parameters and values of the `ent-gtmod` command can be specified only when certain features are enabled, and turned on if necessary.

To specify hexadecimal digits for the `npds` and `nsds` parameters, the Hex Digit Support for GTT feature must be enabled. If hexadecimal digits are shown in the `rtrv-gtmod` output, the Hex Digit Support for GTT feature is enabled.

To specify the `ngti` or `on=gt0fill` parameters, the ANSI/ITU SCCP Conversion feature must be enabled. If values for the `ngti` parameter are shown in the `rtrv-gtmod` output, or the `GT0FILL` value `ON` is shown in the `rtrv-gtmod` output, the ANSI/ITU SCCP Conversion feature is enabled.

Continue the procedure with [6](#) if any of these conditions are present.

- The Hex Digit Support for GTT and ANSI/ITU SCCP Conversion features are enabled.
- If hexadecimal digits will not be specified for the `npds` or `nsds` parameters, and the `ngti` or the `on=gt0fill` parameters will not be specified with the `ent-gtmod` command.

If hexadecimal digits will be specified for the `npds` or `nsds` parameters and hexadecimal digits are not shown in the `rtrv-gtmod` output, continue the procedure with [4](#).

If the `ngti` or `on=gt0fill` parameters will be specified with the `ent-gtmod` command, and values for the `ngti` parameter are not shown in the `rtrv-gtmod` output and the `GT0FILL` value `ON` is not shown in the `rtrv-gtmod` output, continue the procedure with [5](#).

After these steps have been performed, as needed, continue the procedure with [6](#).

- Verify the status of the Hex Digit Support for GTT feature by entering this command.

```
rtrv-ctrl-feat:partnum=893018501
```

The following is an example of the possible output.

```
rlghncxa03w 10-07-28 21:15:37 GMT EAGLE5 42.0.0
```

The following features have been permanently enabled:

Feature Name	Partnum	Status	Quantity
Hex Digit Support for GTT	893018501	on	----

The following features have been temporarily enabled:

Feature Name	Partnum	Status	Quantity	Trial
--------------	---------	--------	----------	-------

Period Left
Zero entries found.

The following features have expired temporary keys:

Feature Name	Partnum
Zero entries found.	

If the Hex Digit Support for GTT feature has not been enabled, perform the [Activating the Hex Digit Support for GTT Feature](#) procedure to enable the Hex Digit Support for GTT feature.

5. Verify the status of the ANSI/ITU SCCP Conversion feature by entering this command.

```
rtrv-ctrl-feat:partnum=893012001
```

The following is an example of the possible output.

```
rlghncxa03w 10-07-28 21:15:37 GMT EAGLE5 42.0.0
The following features have been permanently enabled:
Feature Name      Partnum      Status      Quantity
SCCP Conversion  893012001    on          ----
```

The following features have been temporarily enabled:

Feature Name	Partnum	Status	Quantity	Trial Period
Left				
Zero entries found.				

The following features have expired temporary keys:

Feature Name	Partnum
Zero entries found.	

If the ANSI/ITU SCCP Conversion feature is not enabled, perform [Activating the ANSI/ITU SCCP Conversion Feature](#) to enable the ANSI/ITU SCCP Conversion feature.

6. Add the GT modification information using the `ent-gtmod` command with the parameters and values shown in [Table 2-64](#).

Table 2-64 Add GT Modification Parameter Values

Mandatory Parameter	
:gtmodid=<the GTMOD ID consisting of 1 alphabetic character with up to 8 alphanumeric characters>	
Optional Parameters	
:cgpassn=<2 – 255>	:nsdd=<1 – 21>
:ngti=<2, 4>	:nsds=<1 – 21 decimal digits or 1 – 21 hexadecimal digits>
:nnai=<0 – 127>	:ntt=<0 – 255>

Table 2-64 (Cont.) Add GT Modification Parameter Values

<code>:nnp=<0 – 15></code>	<code>:off=gt0fill</code> – this parameter cannot be specified if the <code>on=gt0fill</code> parameter is specified.
<code>:npdd=<1 – 21></code>	<code>:on=gt0fill</code> – this parameter cannot be specified if the <code>off=gt0fill</code> parameter is specified.
<code>:npds=<1 – 21 decimal digits or 1 – 21 hexadecimal digits></code>	<code>:precd=<pfx or sfx></code> <p><code>pfx</code> - the prefix digits (<code>npds/npdd</code> parameter values) of the received Global Title Address.</p> <p><code>sfx</code> - the suffix digits (<code>nsds/nsdd</code> parameter values) of the received Global Title Address.</p>

Notes:

- a. At least one optional parameter must be specified.
- b. The `on=gt0fill` parameter can be specified only if the `ngti` parameter is specified.
- c. If the `ngti=2` parameter is specified, the `nnai` and `nnp` parameters cannot be specified.
- d. If the `ngti=4` parameter is specified, the `nnai` and `nnp` parameters must be specified.
- e. If either the `npdd/npds` or `nsdd/nsds` parameter combinations are specified, the `precd` parameter cannot be specified.
- f. If the `npdd/npds` and `nsdd/nsds` parameter combinations are specified, the `precd` parameter must be specified.
- g. If the `precd` parameter is specified, the `npdd/npds` and `nsdd/nsds` parameter combinations must be specified.
- h. The combined length of `npds` and `nsds` parameter values cannot exceed 21 digits.

For this example, enter this command.

```
ent-
gtmod:gtmodid=modid6:ngti=4:on=gt0fill:nnp=4:nnai=5:npdd=3 :n
pds=123:nsdd=3:nsds=456:precd=sfx
```

When this command has successfully completed, this message appears.

```
rlghncxa03w 09-05-07 11:43:04 GMT EAGLE5 42.0.0
```

```
GTMOD table is (5 of 100000) 1% full.
```

```
ENT-GTMOD: MASP A - COMPLTD
```

7. Verify the changes by entering the `rtrv-gtmod` command with the `gtmodid` parameter value specified in 6

For this example, enter this command.

```
rtrv-gtmod:gtmodid=modid6
```

This is an example of the possible output.

```
rlghncxa03w 10-07-07 00:27:31 GMT EAGLE5 42.0.0
```

```
GTMODID   NTT   NGTI  GT0FILL  NNP  NNAI  NPDD  NSDD  PRECD  CGPASSN
modid6    --    4      ON     4    5     3     3     SFX    --
          NPDS=123                      NSDS=456
```

```
GTMOD table is (5 of 100000) 1% full.
```

8. Backup the new changes using the `chg-db:action=backup:dest=fixed` command. These messages should appear, the active Maintenance and Administration Subsystem Processor (MASP) appears first.

```
BACKUP (FIXED): MASP A - Backup starts on active MASP.
BACKUP (FIXED): MASP A - Backup on active MASP to fixed disk
complete.
BACKUP (FIXED): MASP A - Backup starts on standby MASP.
BACKUP (FIXED): MASP A - Backup on standby MASP to fixed disk
complete.
```

Figure 2-182 Add Global Title Modification Information - Sheet 1 of 2

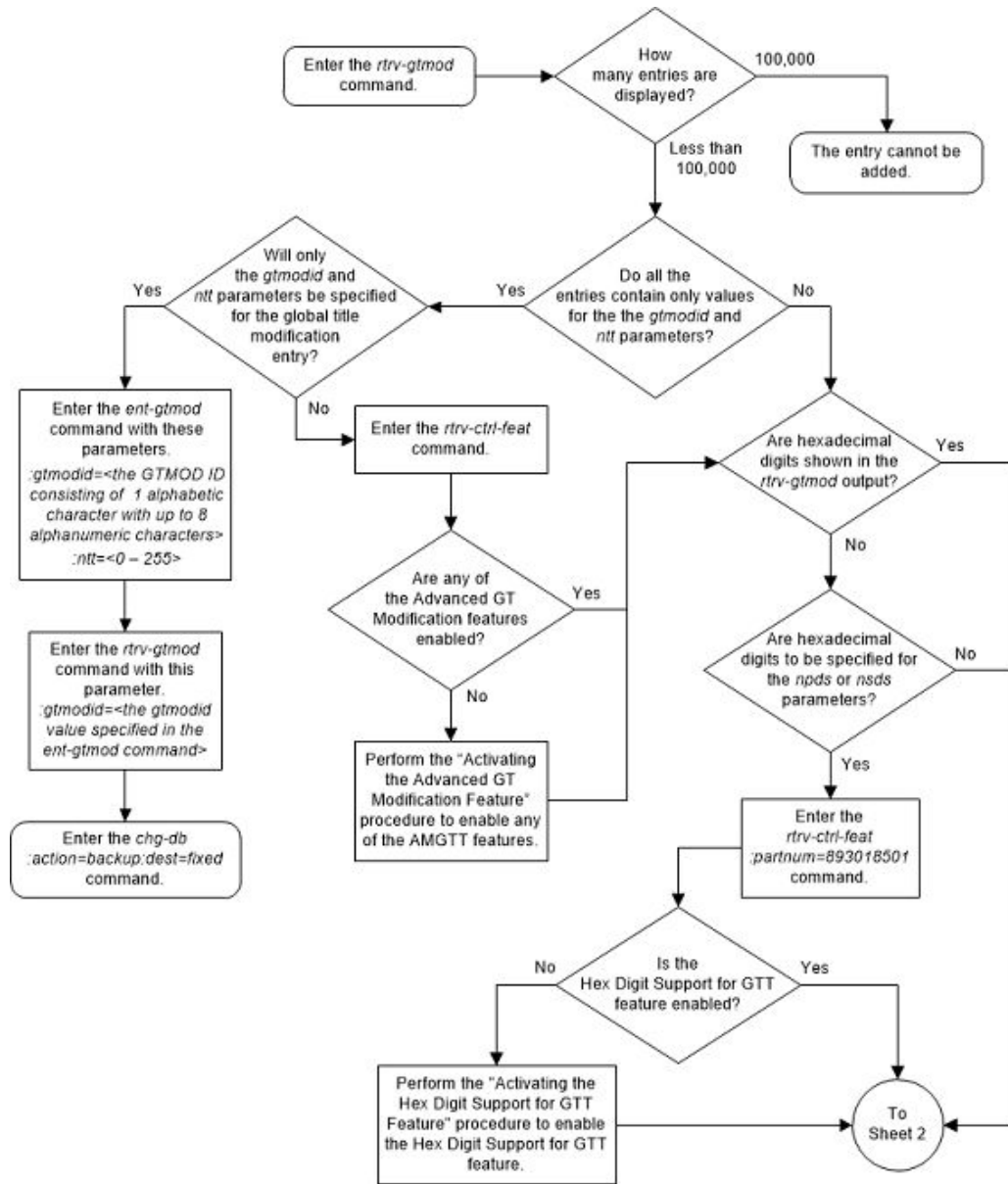
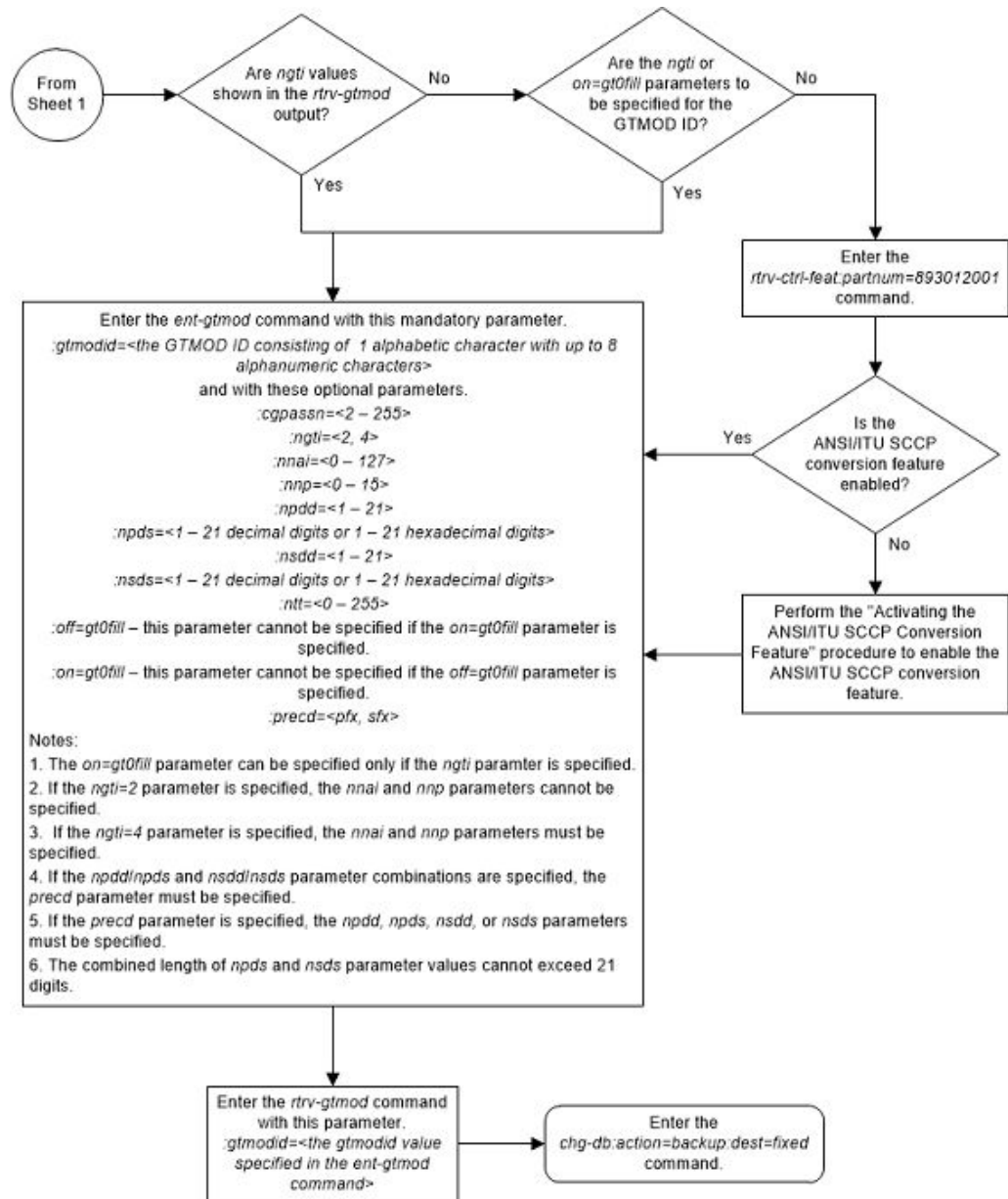

Figure 2-183 Add Global Title Modification Information - Sheet 2 of 2



Removing Global Title Modification Information

This procedure is used to remove existing global title (GT) modification information from the database using the `dlt-gtmod` command and with this parameter.

`:gtmodid - :gtmodid` – The name of the GT modification identifier that contains the GT modification that is being removed.

Other entities in the database reference the GT modification identifier. The number of entities that reference the GT modification identifier is shown in the `REFCNT` field of the `rtrv-gtmod` output. The `REFCNT` field is displayed only when the `on=refcnt` parameter is specified with the `rtrv-gtmod` command.

- GTT entities shown in the `rtrv-gtt` output.
 - GTA entities shown in the `rtrv-gta` output.
 - GTT action entities shown in the `rtrv-gttact` output.
1. Display the GT modification identifiers in the database by entering this command.

```
rtrv-gtmod:on=refcnt
```

This is an example of the possible output.

```
rlghncxa03w 10-07-07 00:27:31 GMT EAGLE5 42.0.0
```

GTMODID	NTT	NGTI	GT0FILL	NNP	NNAI	NPDD	NSDD	PRECD
CGPASSN	REFCNT							
modid2	--	2	ON	--	--	--	--	PFX
--	4							
	NPDS=				NSDS=			
modid5	--	2	OFF	--	--	--	--	PFX
--	0							
	NPDS=				NSDS=			
modid10	--	--	OFF	5	5	--	--	PFX
--	0							
	NPDS=				NSDS=			
modid11	--	--	OFF	5	5	--	--	PFX
--	0							
	NPDS=				NSDS=			
modid20	--	2	ON	--	--	--	--	PFX
--	0							
	NPDS=				NSDS=			
modid6	--	4	ON	4	5	3	3	SFX
--	0							
	NPDS=123				NSDS=456			

```
GTMOD table is (6 of 100000) 1% full.
```

If the reference count value shown in the `REFCNT` column for the GT modification identifier that is being removed from the database is zero (0), continue the procedure with [11](#).

If the reference count value shown in the `REFCNT` column for the GT modification identifier that is being removed from the database is greater than zero (0), continue the procedure with [2](#).

2. Display the GTT sets that are assigned to the GTA entries that reference the GT modification identifier that is being removed by entering the `rtrv-gttset` command with the GT modification identifier shown in [1](#).

```
rtrv-gttset:gtmodid=modid2
```

This is an example of the possible output.

```
rlghncxa03w 10-07-07 00:27:31 GMT EAGLE5 42.0.0
```

GTTSN	NETDOM	SETTYPE	NDGT
setans010	ansi	CDGTA	6

GTT-SET table is (6 of 2000) 1% full.

If no entries are displayed, or if this message is displayed, E3557 Cmd Rej: EGTT must be ON, continue the procedure with the 5.

If entries are displayed, continue the procedure with 3.

3. Display the global title address (GTA) information associated with the for the GTT sets displayed in 2 by entering the `rtrv-gta` command with these parameters.

- `:gttsn` - the GTTSN value shown in 2.
- `:gtmodid` - the `gtmodid` parameter value specified in 2.

```
rtrv-gta:gttsn=setans010:gtmodid=modid2
```

This is an example of the possible output.

```
rlghncxa03w 10-07-07 00:28:31 GMT EAGLE5 42.0.0
```

```
GTTSN      NETDOM  SETTYPE  NDGT
setans010  ansi     CDGTA    6
```

GTA table is (6 of 269999) 1% full.

```
START GTA END GTA  XLAT  RI    PC
919460   919460   DPC    SSN    002-002-002
          MAPSET=DFLT  SSN=--- CCGT=no CGGTMOD=NO
          GTMODID=modid2  TESTMODE=off
          OPTSN=----- CGSELID=----- OPCS=-----
          ACTSN=----- PPMEASREQD= NO
```

Command Retrieved 1 Entries

Perform one of these procedures.

- [Removing Global Title Address Information](#) - to remove the GTA entries that are displayed in this step from the database.
- [Changing Global Title Address Information](#) - to change the reference to the GT modification identifier in the GTA entries displayed in this step.

If all the GTA entires in all the GTT sets that are displayed in 2 have not been displayed, repeat this step for the other GTT sets displayed in 2.

If all the GTA entires in all the GTT sets that are displayed in 2 have been displayed, continue the procedure with 4.

4. Display the GT modification identifier that is being removed from the database by entering the `rtrv-gtmod` command with these parameters.

- `:on=refcnt`
- `:gtmodid` - the `gtmodid` parameter value specified in 3.

This is an example of the possible output.

```
rlghncxa03w 10-07-07 00:27:31 GMT EAGLE5 42.0.0

GTMODID  NTT  NGTI  GT0FILL  NNP  NNAI  NPDD  NSDD  PRECD
CGPASSN  REFCNT
modid2   --    2      ON    --    --    --    --    PFX
--       3
        NPDS=                NSDS=

GTMOD table is (6 of 100000) 1% full.
```

If the reference count value shown in the `REFCNT` column for the GT modification identifier that is being removed from the database is zero (0), continue the procedure with [11](#).

If the reference count value shown in the `REFCNT` column for the GT modification identifier that is being removed from the database is greater than zero (0), continue the procedure with [5](#).

5. Display the translation type in the database by entering the `rtrv-tt`.

This is an example of the possible output.

```
rlghncxa03w 10-07-07 00:27:31 GMT EAGLE5 42.0.0

TYPEA    TTN          NDGT
  10     setans010    6
  20     ansi20     6

ALIAS    TYPEA

TYPEI    TTN          NDGT
  2      setint002    6
  25     itu25     6
  75     setint075    6

ALIAS    TYPEI

TYPEN    TTN          NDGT

ALIAS    TYPEN

TYPEN24  TTN          NDGT

ALIAS    TYPEN24

TYPEIS   TTN          NDGT
  2      setins002    6

ALIAS    TYPEIS

TYPENS   TTN          NDGT

ALIAS    TYPENS
```

6. Display the global title translation (GTT) entry associated with one of the translation types shown in 5 by entering the `rtrv-gtt` command with these parameters.
- `:type/typea/typei/typeis/typen/typens/typen24` - the translation type value shown in 5.
 - `:gtmodid` - the GT modification identifier that is being removed.

For this example, enter this command

```
rtrv-gtt:typei=75:gtmodid=modid2
```

This is an example of the possible output.

```
rlghncxa03w 10-07-07 00:28:31 GMT EAGLE5 42.0.0
```

```
TYPEI      TTN          NDGT
 75        setint075    6
```

GTA table is (6 of 269999) 1% full.

```
START GTA          END GTA          XLAT  RI      PC
910460             910460          DPC   SSN    2-002-2
      MAPSET=DFLT  SSN=---  GTMODID=modid2    CGGTMOD = NO
```

Command Retrieved 1 Entries

If no entries are displayed and all the GTT entries for all the translation types have been displayed, continue the procedure with 7.

If no entries are displayed and all the GTT entries for all the translation types have not been displayed, repeat this step for one of the other translation type shown in 5.

If entries are displayed, perform one of these procedures.

- [Removing a Global Title Translation](#) - to remove the GTT entries that are displayed in this step from the database.
- [Changing a Global Title Translation](#) - to change the reference to the GT modification identifier in the GTT entries displayed in this step.

If all the GTT entries in all the translation types that are displayed in 5 have not been displayed, repeat this step for the other translation types displayed in 5.

If all the GTT entries in all the translation types that are displayed in 5 have been displayed, continue the procedure with 7.

7. Display the GT modification identifier that is being removed from the database by entering the `rtrv-gtmod` command with these parameters.
- `:on=refcnt`
 - `:gtmodid` - the `gtmodid` parameter value specified in 6.

This is an example of the possible output.

```
rlghncxa03w 10-07-07 00:27:31 GMT EAGLE5 42.0.0
```

```

GTMODID   NTT   NGTI   GT0FILL   NNP   NNAI   NPDD   NSDD   PRECD
CGPASSN   REFCNT
modid2    --    2      ON    --    --    --    --    PFX
--        2
          NPDS=                    NSDS=

```

GTMOD table is (6 of 100000) 1% full.

If the reference count value shown in the `REFCNT` column for the GT modification identifier that is being removed from the database is zero (0), continue the procedure with [11](#).

If the reference count value shown in the `REFCNT` column for the GT modification identifier that is being removed from the database is greater than zero (0), continue the procedure with [8](#).

8. Display the GTT actions that may reference the GT modification identifier that is being removed by entering the `rtrv-gttact` with the `cdgtmodid` parameter.

For this example, enter this command.

```
rtrv-gttact:cdgtmodid=modid2
```

This is an example of the possible output.

```
rlghncxa03w 10-07-07 00:27:31 GMT EAGLE5 42.0.0
```

```

ACTID      ACTION   ATCAPERR ITCAPERR UDTSEERR UIMREQD
-----
ACTID      ACTION   PCA           RI  SSN  MRNSET  MAPSET
-----
---
action1    dup      002-002-002  gt  ---  DFLT    -----
          CDGTMODID = modid2      CGGTMODID = -----
          USEICMSG = off      CGPCOGMSG = dflt      CGPCA = ---
ACTID      ACTION   PCI           RI  SSN  MRNSET  MAPSET
-----
---
ACTID      ACTION   PCN           RI  SSN  MRNSET  MAPSET
-----
---
ACTID      ACTION   PCN24        RI  SSN  MRNSET  MAPSET
-----
---

```

GTT-ACT table is (3 of 2000) 1% full.

If no entries are displayed, continue the procedure with 10.

If entries are displayed, perform one of these procedures.

- [Removing a GTT Action](#) - to remove the GTT action entries that are displayed in this step from the database.
- [Changing a GTT Action](#) - to change the reference to the GT modification identifier in the GTT action entries displayed in this step.

After the entries displayed in this step have either been removed or changed, continue the procedure with 9.

9. Display the GT modification identifier that is being removed from the database by entering the `rtrv-gtmod` command with these parameters.

- `:on=refcnt`
- `:gtmodid` - the `gtmodid` parameter value specified in 8.

This is an example of the possible output.

```
rlghncxa03w 10-07-07 00:27:31 GMT EAGLE5 42.0.0

GTMODID  NTT  NGTI  GT0FILL  NNP  NNAI  NPDD  NSDD  PRECD
CGPASSN  REFCNT
modid2   --    2      ON    --    --    --    --    PFX
--       1
        NPDS=                NSDS=

GTMOD table is (6 of 100000) 1% full.
```

If the reference count value shown in the `REFCNT` column for the GT modification identifier that is being removed from the database is zero (0), continue the procedure with 11.

If the reference count value shown in the `REFCNT` column for the GT modification identifier that is being removed from the database is greater than zero (0), continue the procedure with 10.

10. Display the GTT actions that may reference the GT modification identifier that is being removed by entering the `rtrv-gttact` with the `cggtmodid` parameter.

For this example, enter this command.

```
rtrv-gttact:cggtmodid=modid2
```

This is an example of the possible output.

```
rlghncxa03w 10-07-07 00:27:31 GMT EAGLE5 42.0.0

ACTID      ACTION  ATCAPERR  ITCAPERR  UDTSEERR  UIMREQD
-----

ACTID      ACTION  PCA          RI  SSN  MRNSET  MAPSET
-----
---
action3    dup      003-003-003  gt  ---  1      -----
          CDGTMODID = -----  CGGTMODID = modid2
```



```
USEICMSG = off      CGPCOGMSG = dflt      CGPCA = ---
```

```
ACTID      ACTION  PCI          RI  SSN  MRNSET  MAPSET
-----
---
```

```
ACTID      ACTION  PCN          RI  SSN  MRNSET  MAPSET
-----
---
```

```
ACTID      ACTION  PCN24       RI  SSN  MRNSET  MAPSET
-----
---
```

GTT-ACT table is (3 of 2000) 1% full.

Perform one of these procedures.

- [Removing a GTT Action](#) - to remove the GTT action entries that are displayed in this step from the database.
- [Changing a GTT Action](#) - to change the reference to the GT modification identifier in the GTT action entries displayed in this step.

After the entries displayed in this step have either been removed or changed, continue the procedure with [11](#).

- 11.** Remove the GT modification information using the `dlt-mod` command with the GT modification identifier.

For this example, enter this command.

```
dlt-gtmod:gtmodid=modid2
```

When this command has successfully completed, this message appears.

```
rlghncxa03w 10-07-07 00:29:31 GMT EAGLE5 42.0.0
```

GTMOD table is (5 of 100000) 1% full.

```
DLT-GTMOD: MASP A - COMPLTD
```

- 12.** Verify the changes by entering the `rtrv-gtmod` command with the `gtmodid` parameter value specified in [11](#).

```
rtrv-gtmod:gtmodid=modid2
```

This message should be displayed.

```
rlghncxa03w 10-07-07 00:28:31 GMT EAGLE5 42.0.0
E5285 Cmd Rej: GTMODID does not exist
```

- 13.** Backup the new changes using the `chg-db:action=backup:dest=fixed` command.

These messages should appear, the active Maintenance and Administration Subsystem Processor (MASP) appears first.

BACKUP (FIXED) : MASP A - Backup starts on active MASP.
 BACKUP (FIXED) : MASP A - Backup on active MASP to fixed disk complete.
 BACKUP (FIXED) : MASP A - Backup starts on standby MASP.
 BACKUP (FIXED) : MASP A - Backup on standby MASP to fixed disk complete.

Figure 2-184 Remove Global Title Modification Information - Sheet 1 of 3

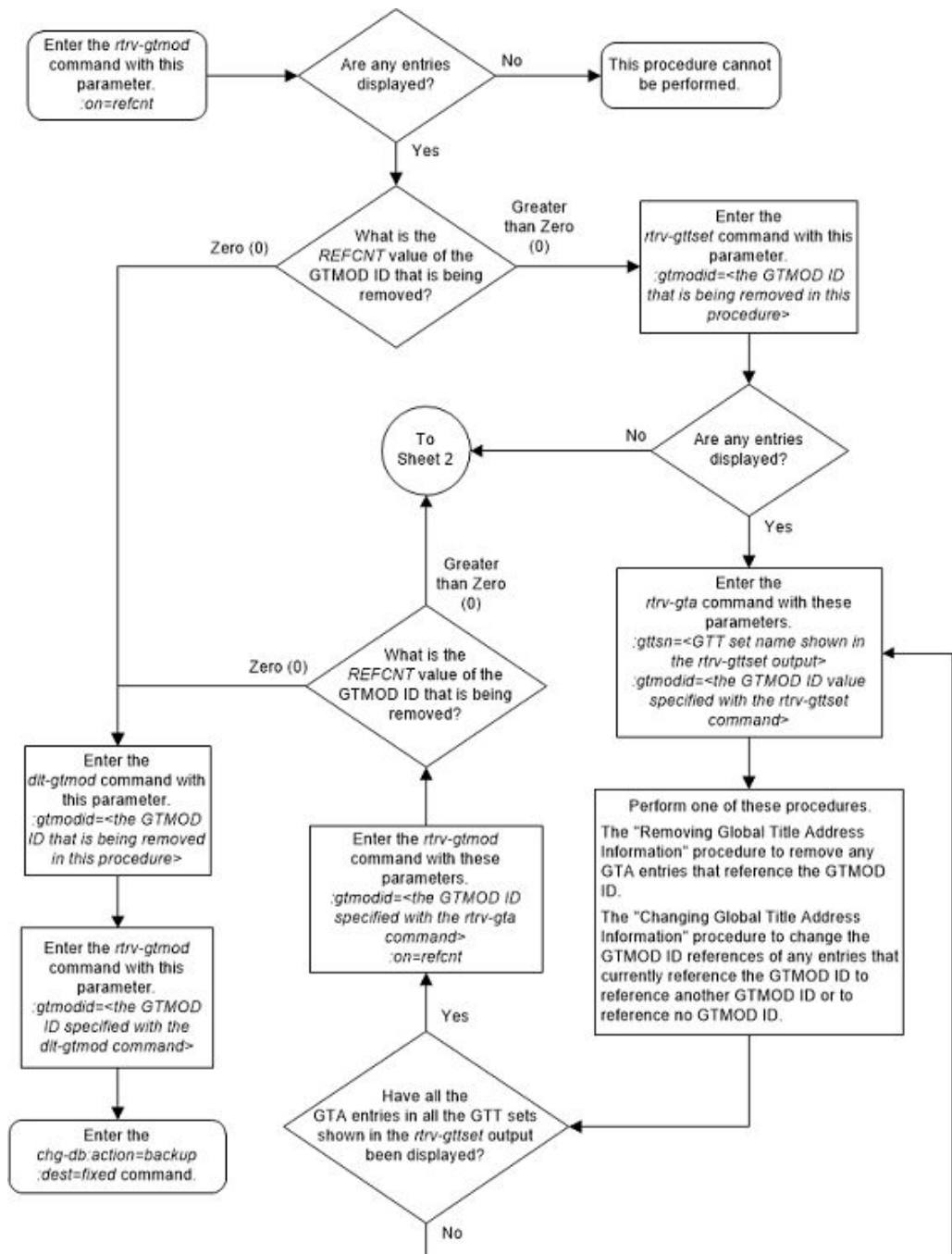

Figure 2-185 Remove Global Title Modification Information - Sheet 2 of 3

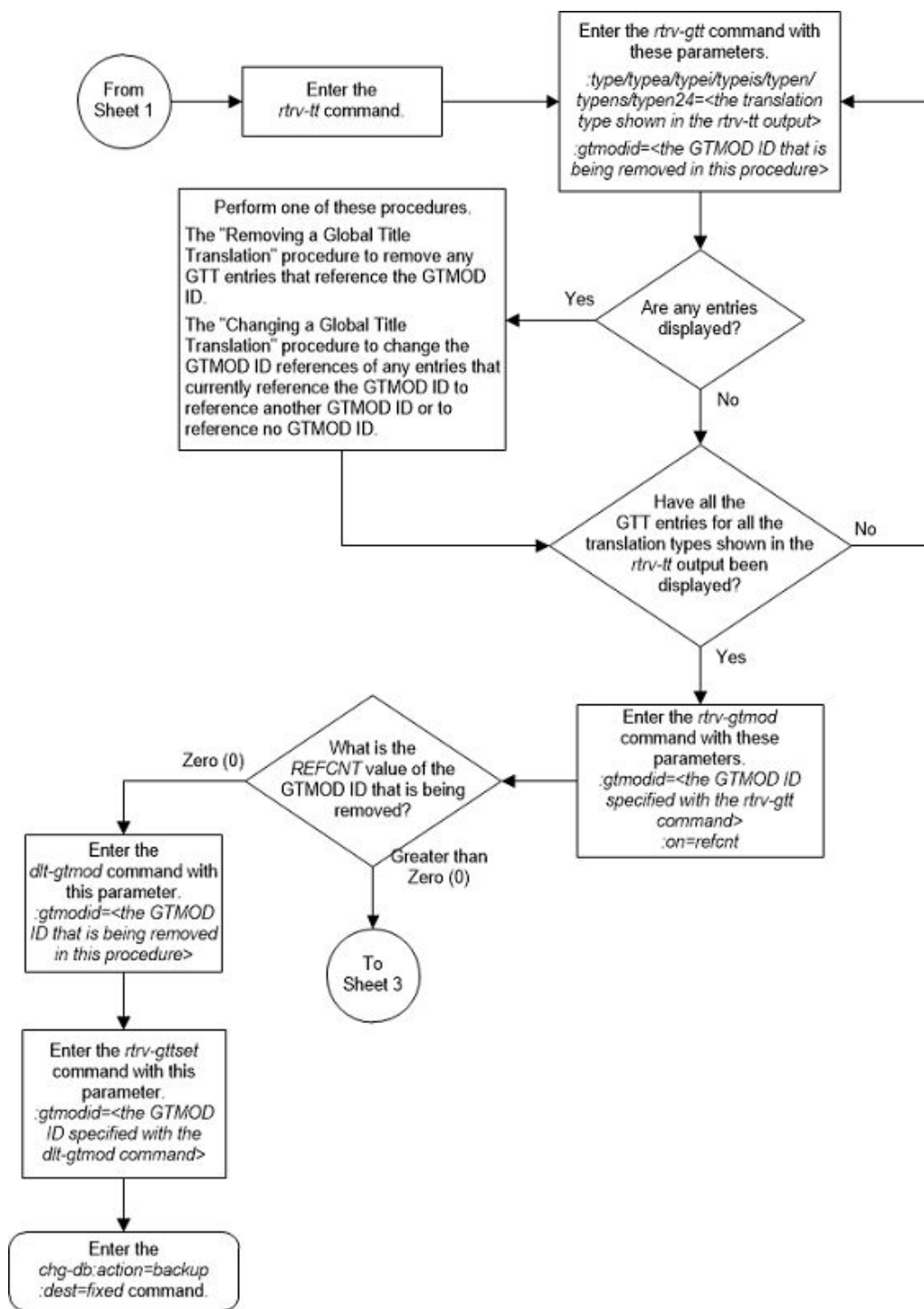
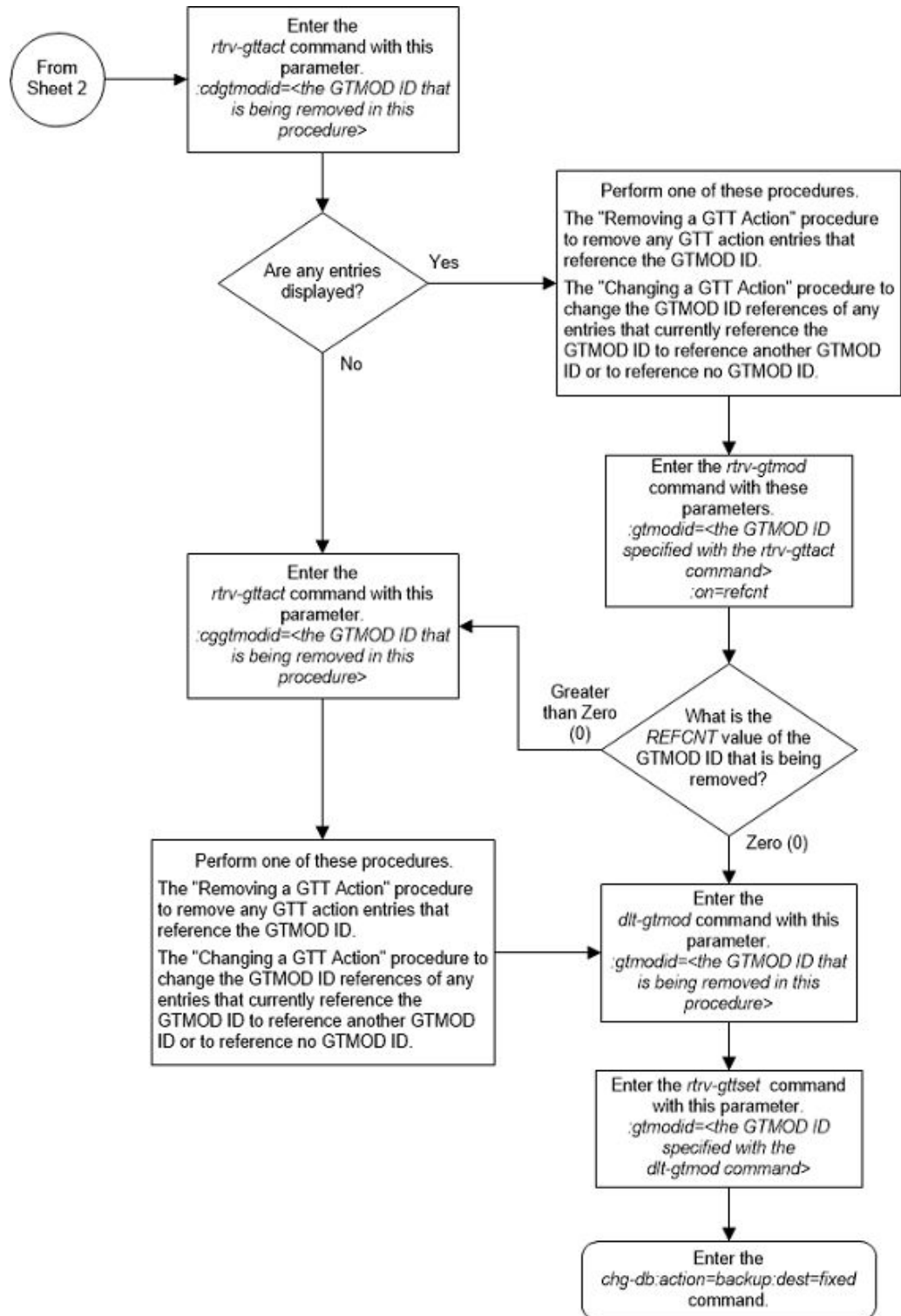

Figure 2-186 Remove Global Title Modification Information - Sheet 3 of 3



Changing Global Title Modification Information

This procedure is used to change the attributes of global title (GT) modification information in the database. The GT modification information is changed using the `chg-gtmod` command with these parameters.

`:gtmodid` – The current name of the GT modification identifier

`:ngtmodid` – The new name of the GT modification identifier

`:cgpassn` – The subsystem number in the calling party address

`:ntt` – The new translation type

`:nnp` – The new numbering plan

`:nnai` – The new nature of address indicator

`:npdd` – The number of digits to be deleted from the beginning of the Global Title Address digits (the prefix digits)

`:npds` – The digits that are being substituted for the prefix digits

`:nsdd` – The number of digits to be deleted from the end of the Global Title Address digits (the suffix digits)

`:nsds` – The digits that are being substituted for the suffix digits

`:ngti` – The new GT indicator value

`on=gt0fill` - if the last value of the global title address is zero (0), it is treated or as a filler during the GT modification process.

`off=gt0fill` - if the last value of the global title address is zero (0), it is treated as a valid digit during the GT modification process.

`precd` - specifies whether the prefix (`npds/npdd` parameter values) or suffix (`nsds/nsdd` parameter values) takes precedence while modifying the received Global Title Address.

The values for these parameters and the rules for using these parameters are shown in [Table 2-65](#).

The `nnp`, `nnai`, `npdd`, `npds`, `nsdd`, and `nsds` parameters are used by the Advanced GT Modification feature to modify the numbering plan, nature of address indicator, and the prefix digits, the suffix digits, or both the prefix and suffix digits in the called party address portion of outbound MSUs in addition to the translation type when the MSU requires further global title translation and the translation type is to be replaced. Refer to the [Advanced GT Modification Feature](#) section for more information about the Advanced GT Modification feature.

Being able to change the numbering plan, nature of address indicator, and either the prefix or suffix digits in the called party address portion of outbound MSUs makes the MSU more compatible with the network that the MSU is being sent to and to ensure that the MSU is routed correctly. These changes are made after the global title translation process, but before the MSU is routed to its destination.

To specify a value of 2 or 4 for the `ngti` parameter, the ANSI/ITU SCCP Conversion feature must be enabled. Verify the status of the ANSI/ITU SCCP Conversion feature

with the `rtrv-ctrl-feat` command. Refer to the [ANSI/ITU SCCP Conversion Feature](#) section for more information about the ANSI/ITU SCCP Conversion feature. If the ANSI/ITU SCCP Conversion feature is not enabled, perform the [Activating the ANSI/ITU SCCP Conversion Feature](#) procedure to enable the ANSI/ITU SCCP Conversion feature.

The values specified for the `npds` and `nsds` parameters can be decimal digits (0-9) or hexadecimal digits (0-9, a-f, A-F). Hexadecimal digits can be specified only if the Hex Digit Support for GTT feature is enabled. Verify the status of the Hex Digit Support for GTT feature with the `rtrv-ctrl-feat` command. Refer to the [Hex Digit Support for GTT](#) section for more information about the Hex Digit Support for GTT feature. If the Hex Digit Support for GTT feature is not enabled, perform the [Activating the Hex Digit Support for GTT Feature](#) procedure to enable the Hex Digit Support for GTT feature.

1. Display the GT modification information in the database using the `rtrv-gtmod` command.

This is an example of the possible output.

```
rlghncxa03w 10-07-07 00:29:31 GMT EAGLE5 42.0.0
```

GTMODID	NTT	NGTI	GT0FILL	NNP	NNAI	NPDD	NSDD	PRECD	CGPASSN
modid2	--	2	ON	--	--	--	--	PFX	--
modid5	--	2	OFF	--	--	--	--	PFX	--
modid6	--	4	ON	4	5	3	3	SFX	--
modid10	--	--	OFF	5	5	--	--	PFX	--
modid11	--	--	OFF	5	5	--	--	PFX	--

```
GTMOD table is (5 of 100000) 1% full.
```

If entries are not displayed, this procedure cannot be performed.

If entries are displayed, continue the procedure by performing one of these steps.

- If only the `gtmodid` or `ntt` parameter values will be changed, continue the procedure with [6](#).
 - If the values for other parameters besides the `gtmodid` and `ntt` parameter values will be changed, continue the procedure by performing one of these steps.
 - If any of the entries shown in the `rtrv-gtmod` output contains values for parameters other than the `gtmodid` and `ntt` parameters, continue the procedure with [3](#).
 - If all of the entries shown in the `rtrv-gtmod` output contains only values for the `gtmodid` and `ntt` parameters, continue the procedure with [2](#).
2. One of the Advanced GT Modification features must be enabled to change the values of the parameters other than the `gtmodid` and `ntt` parameters. Enter the `rtrv-ctrl-feat` command to verify if any of the Advanced GT Modification features are enabled.

If any of the Advanced GT Modification features are enabled, one of these entries is shown in the `rtrv-ctrl-feat` output.

Feature	Part Number
AMGTT	893021801
AMGTT CdPA Only	893021802
AMGTT CgPA Upgrade	893021803

The following is an example of the possible output.

```
rlghncxa03w 10-07-28 21:15:37 GMT EAGLE5 42.0.0
The following features have been permanently enabled:
```

Feature Name	Partnum	Status	Quantity
XGTT Table Expansion	893006101	on	400000
Command Class Management	893005801	on	----
LNP Short Message Service	893006601	on	----
Intermed GTT Load Sharing	893006901	on	----
HC-MIM SLK Capacity	893012707	on	64

The following features have been temporarily enabled:

Feature Name	Partnum	Status	Quantity	Trial
Period Left				
Zero entries found.				

The following features have expired temporary keys:

Feature Name	Partnum
Zero entries found.	

If none of the Advanced GT Modification features are enabled, perform the [Activating the Advanced GT Modification Feature](#) procedure to enable any of the Advanced GT Modification features.

- For some parameters and values of the `chg-gtmod` command to be specified, these conditions must be present.

To specify hexadecimal digits for the `npds` and `nsds` parameters, the Hex Digit Support for GTT feature must be enabled. If hexadecimal digits are shown in the `rtrv-gtmod` output, the Hex Digit Support for GTT feature is enabled.

To specify the `ngti` parameter value 2 or 4, or the `on=gt0fill` parameter, the ANSI/ITU SCCP Conversion feature must be enabled. If values 2 or 4 for the `ngti` parameter are shown in the `rtrv-gtmod` output, or the `GT0FILL` value `ON` is shown in the `rtrv-gtmod` output, the ANSI/ITU SCCP Conversion feature is enabled.

To specify the value `none` for the `ngti` parameter, the `GT0FILL` value must be `OFF`.

If the `gt0fill` value will be changed to `on`, the `ngti` value must be 2 or 4.

If the `ngti` value will be changed to 4, the `nnp` and `nnai` parameters must be specified and their values cannot be `none`. The network type of the point code in

the entity that references the GT modification identifier that is being changed must be ITU.

If the `ngti` value will be changed from 4 to 2, the `nnp` and `nnai` parameter values will be removed from the GT modification identifier.

If the `ngti` value is 2 when this procedure is finished, the `nnp` and `nnai` parameters cannot be specified.

If the `ngti` parameter will have no value when this procedure is finished (`ngti=none`), the `nnp` and `nnai` parameters can be specified.

Continue the procedure with 6 if any of these conditions are present.

- The Hex Digit Support for GTT and ANSI/ITU SCCP Conversion features are enabled.
- If hexadecimal digits will not be specified for the `npds` or `nsds` parameters, and the `ngti` or the `on=gt0fill` parameters will not be specified with the `chg-gtmod` command.

If hexadecimal digits will be specified for the `npds` or `nsds` parameters and hexadecimal digits are not shown in the `rtrv-gtmod` output, continue the procedure with 4.

If the `ngti` parameter values 2 or 4, or the `on=gt0fill` parameter will be specified with the `chg-gtmod` command, and values 2 or 4 for the `ngti` parameter are not shown in the `rtrv-gtmod` output or the `GT0FILL` value `ON` is not shown in the `rtrv-gtmod` output, continue the procedure with 5.

After these steps have been performed, as needed, continue the procedure with 6.

4. Verify the status of the Hex Digit Support for GTT feature by entering this command.

```
rtrv-ctrl-feat:partnum=893018501
```

The following is an example of the possible output.

```
rlghncxa03w 10-07-28 21:15:37 GMT EAGLE5 42.0.0
```

The following features have been permanently enabled:

Feature Name	Partnum	Status	Quantity
Hex Digit Support for GTT	893018501	on	----

The following features have been temporarily enabled:

Feature Name	Partnum	Status	Quantity	Trial
Period Left				
Zero entries found.				

The following features have expired temporary keys:

Feature Name	Partnum
Zero entries found.	

If the Hex Digit Support for GTT feature has not been enabled, perform the [Activating the Hex Digit Support for GTT Feature](#) procedure to enable the Hex Digit Support for GTT feature.

- Verify the status of the ANSI/ITU SCCP Conversion feature by entering this command.

```
rtrv-ctrl-feat:partnum=893012001
```

The following is an example of the possible output.

```
rlghncxa03w 10-07-28 21:15:37 GMT EAGLE5 42.0.0
The following features have been permanently enabled:
Feature Name      Partnum      Status      Quantity
SCCP Conversion   893012001    on          ----
```

The following features have been temporarily enabled:

```
Feature Name      Partnum      Status      Quantity      Trial Period
Left
Zero entries found.
```

The following features have expired temporary keys:

```
Feature Name      Partnum
Zero entries found.
```

If the ANSI/ITU SCCP Conversion feature is not enabled, perform [Activating the ANSI/ITU SCCP Conversion Feature](#) procedure to enable the ANSI/ITU SCCP Conversion feature.

- Change the GT modification identifier using the `chg-gtmod` command with the parameters and values shown in [Table 2-65](#).

Table 2-65 Change GT Modification Parameter Values

Mandatory Parameter	
:gtmodid=<the current GTMOD ID shown in the <code>rtrv-gtmod</code> output>	
Optional Parameters	
:cgpassn=<2 – 255, or none>	:nsdd=<1 – 21, or none>
:ngti=<2, 4, or none>	:nsds=<1 – 21 decimal digits, 1 – 21 hexadecimal digits, or none>
:nnai=<0 – 127, or none>	:ntt=<0 – 255, or none>
:nnp=<0 – 15, or none>	:off=gt0fill – this parameter cannot be specified if the on=gt0fill parameter is specified.
:npdd=<1 – 21, or none>	:on=gt0fill – this parameter cannot be specified if the off=gt0fill parameter is specified.
:npds=<1 – 21 decimal digits, 1 – 21 hexadecimal digits, or none>	:precd=<pfx or sfx>
	pfx - the prefix digits (<code>npds/npdd</code> parameter values) of the received Global Title Address.
	sfx - the suffix digits (<code>nsds/nsdd</code> parameter values) of the received Global Title Address.

Table 2-65 (Cont.) Change GT Modification Parameter Values

:ngtmodid=<the new GTMOD ID consisting of 1 alphabetic character with up to 8 alphanumeric characters>

Notes:

- a. At least one optional parameter must be specified.
- b. If either the npdd/npds or nsdd/nsds parameter combinations are specified, the precd parameter cannot be specified.
- c. If the npdd/npds and nsdd/nsds parameter combinations are specified, the precd parameter must be specified.
- d. If the precd parameter is specified, the npdd/npds and nsdd/nsds parameter combinations must be specified.
- e. The combined length of npds and nsds parameter values cannot exceed 21 digits.
- f. The ngtmodid parameter changes the references from the current gtmodid value to the new gtmodid value in the entities that reference the current gtmodid value.
- g. See 3 for other requirements for using these parameters.

For this example, enter this command.

```
chg-
gtmod:gtmodid=modid6:ngti=2:gt0fill=off:prec=pfx:npdd=4:npds
=2345 :nsdd=4:nsds=12ae:ngtmodid=modid7
```

When the command has successfully completed, this message appears.

```
rlghncxa03w 10-07-07 00:27:31 GMT EAGLE5 42.0.0
```

```
GTMOD table is (5 of 100000) 1% full.
```

```
CHG-GTMOD: MASP A - COMPLTD
```

7. Verify the changes by entering the rtrv-gtmod command with the gtmodid parameter. The gtmodid parameter value is the gtmodid parameter value, if the GT modification identifier was not changed, or the ngtmodid parameter value, if the GT modification identifier was changed, that was specified in 6. For this example, enter this command.

```
rtrv-gtmod:gtmodid=modid7
```

This is an example of the possible output.

```
rlghncxa03w 10-07-07 00:28:31 GMT EAGLE5 42.0.0
```

GTMODID	NTT	NGTI	GT0FILL	NNP	NNAI	NPDD	NSDD	PRECD	CGPASSN
modid7	--	2	OFF	--	--	4	4	PFX	--
						NPDS=2345			NSDS=12ae

```
GTMOD table is (5 of 100000) 1% full.
```

- Backup the new changes using the `chg-db:action=backup:dest=fixed` command. These messages should appear, the active Maintenance and Administration Subsystem Processor (MASP) appears first.

```

BACKUP (FIXED) : MASP A - Backup starts on active MASP.
BACKUP (FIXED) : MASP A - Backup on active MASP to fixed disk complete.
BACKUP (FIXED) : MASP A - Backup starts on standby MASP.
BACKUP (FIXED) : MASP A - Backup on standby MASP to fixed disk complete.
    
```

Figure 2-187 Change Global Title Modification Information - Sheet 1 of 5

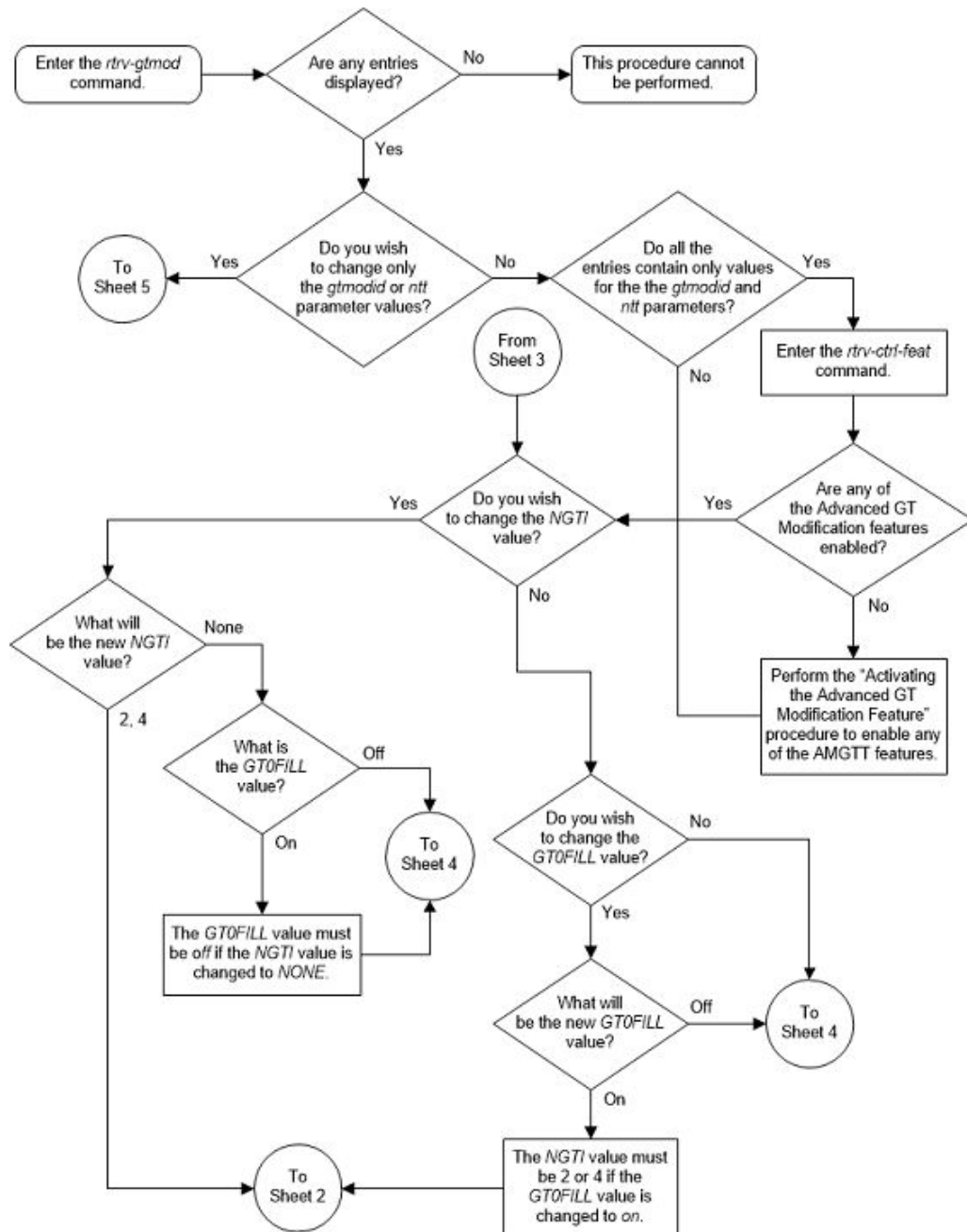

Figure 2-188 Change Global Title Modification Information - Sheet 2 of 5

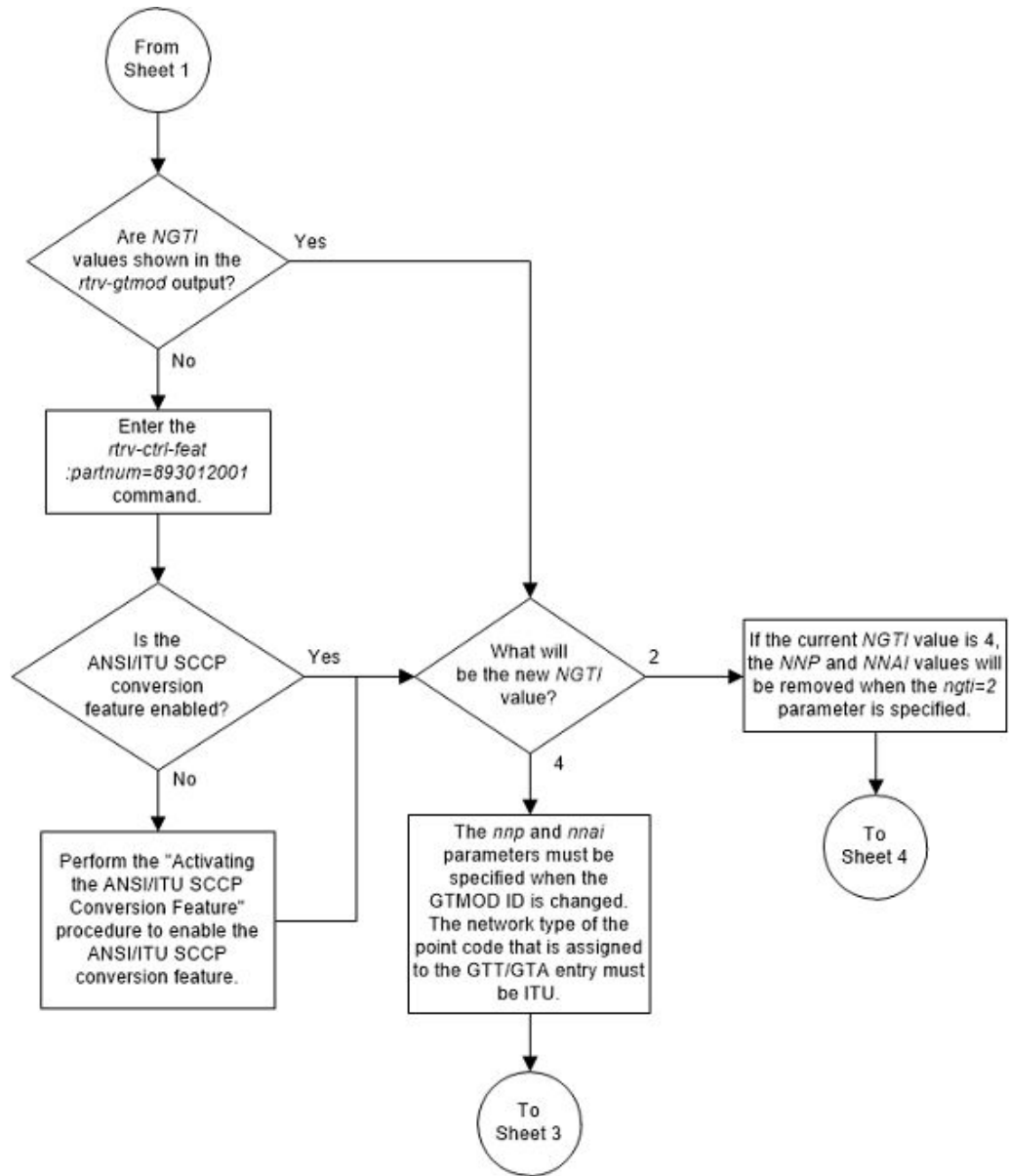

Figure 2-189 Change Global Title Modification Information - Sheet 3 of 5

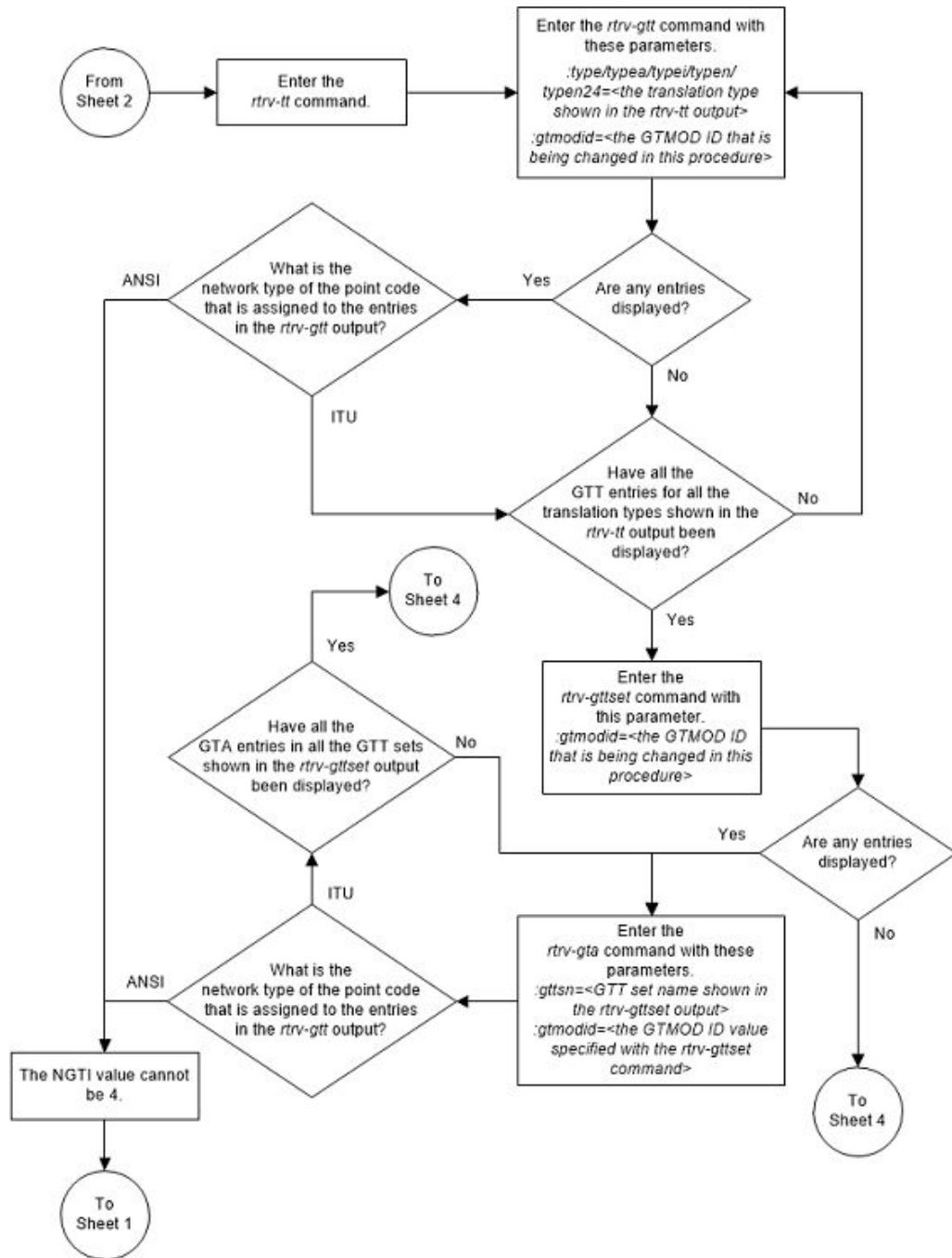

Figure 2-190 Change Global Title Modification Information - Sheet 4 of 5

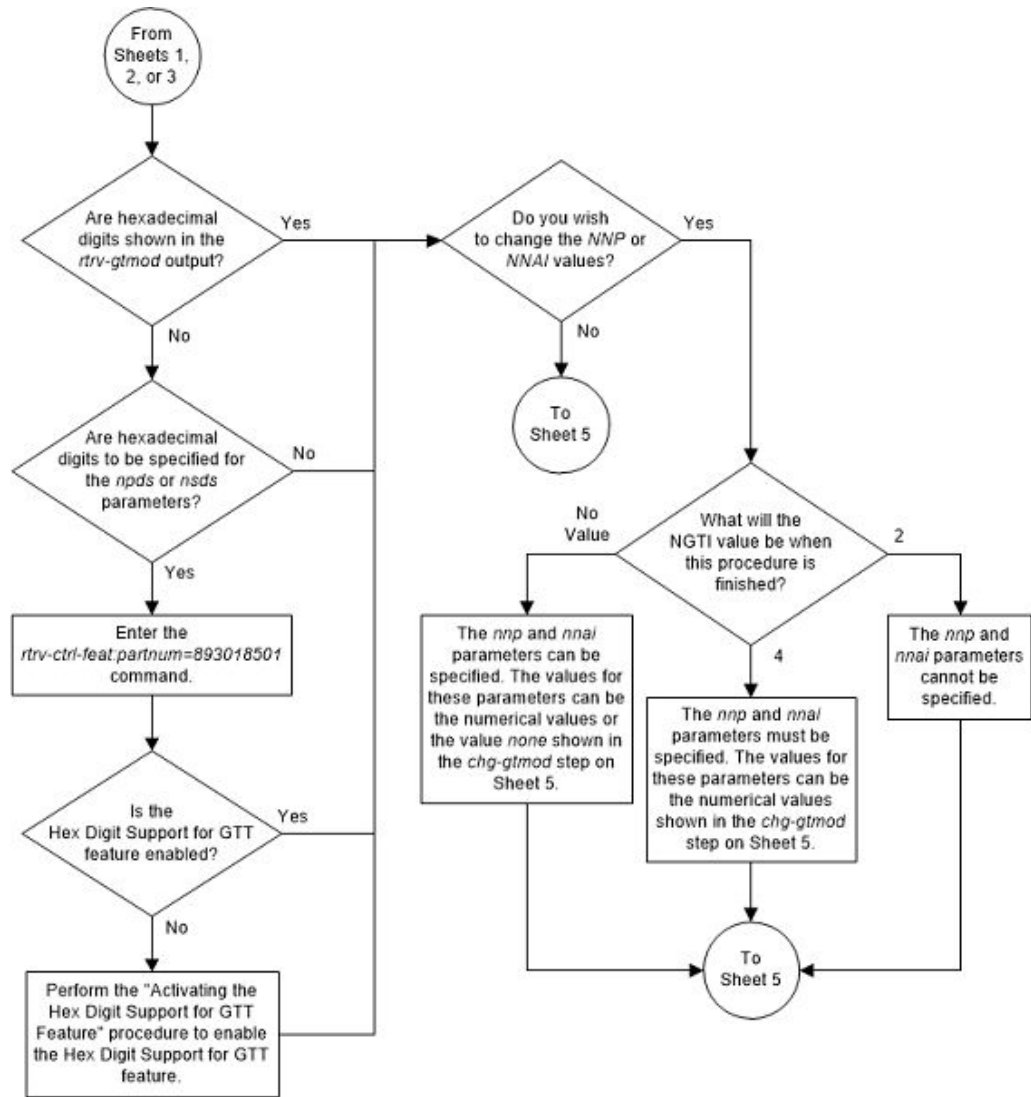
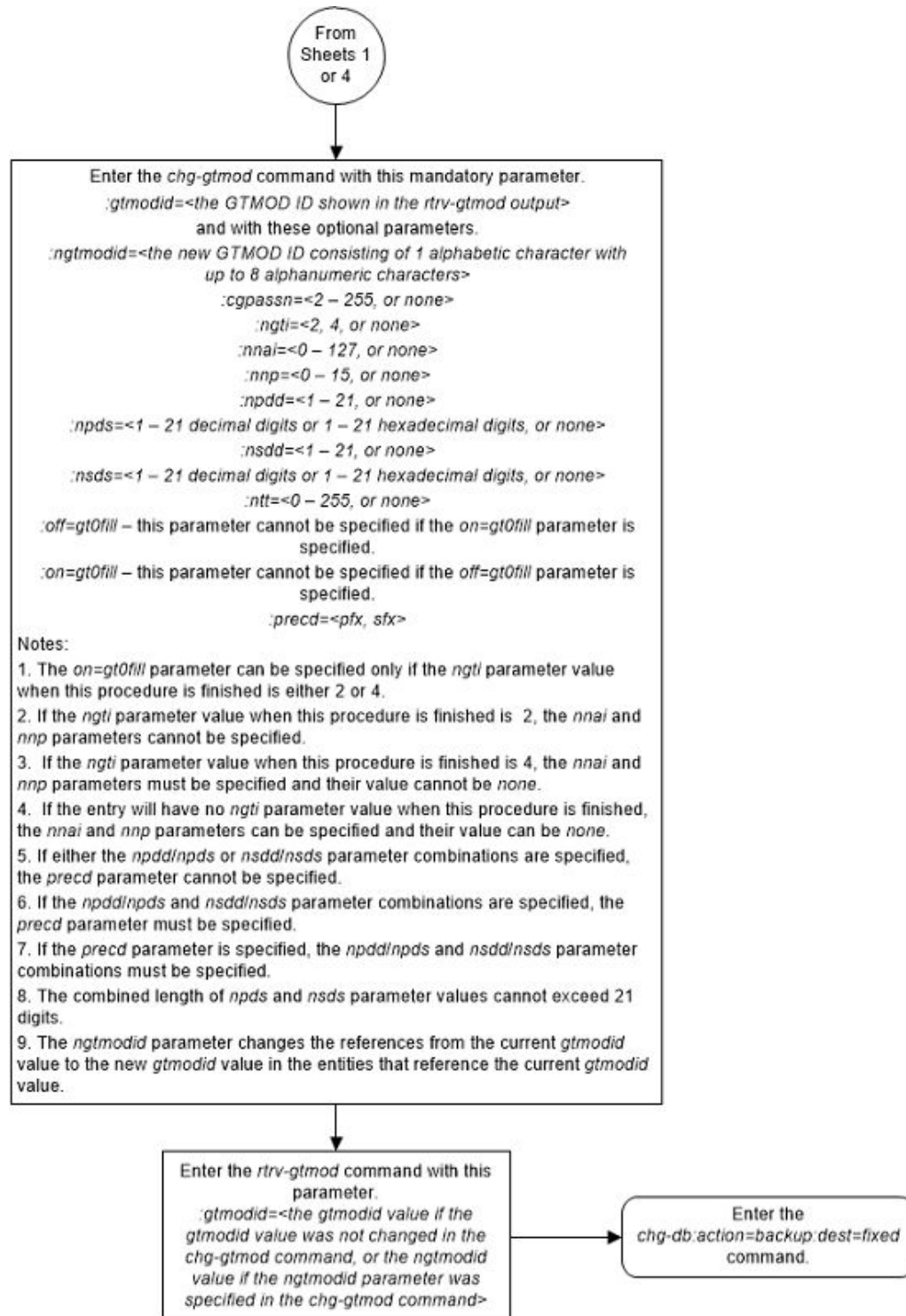

Figure 2-191 Change Global Title Modification Information - Sheet 5 of 5



Changing the MTP-Routed GTT Options

This procedure is used to change the MTP-routed GTT options using the `chg-sccpopts` command with these parameters.

`:mtprgtt` – This parameter specifies whether global title translation is performed on an MTP-routed message and how the message is routed after global title translation is performed on the message. This parameter has three values.

- `off` - global title translation is not performed on the MTP-routed message.
- `usemtpgc` - global title translation is performed on the MTP-routed message and is then routed to the original DPC.
- `fullgtt` - global title translation is performed on the MTP-routed message and is then routed to the translated DPC.

`:mtprgttfallbk` – this parameter specifies whether an MTP-routed message is MTP-routed after global title translation on the message has failed. This parameter has two values.

- `mtproute` - perform MTP-routing on the message if global title translation on the message fails.
- `gttfail` - discard the message if global title translation on the message fails. Send a UDTs if required.

This procedure can be performed only if the MTP Routed GWS Stop Action feature or the MTP Msgs for SCCP Apps feature is enabled. The status of these features is shown in the `rtrv-ctrl-feat` output.

1. Display the existing default GTT mode values by entering the `rtrv-sccpopts` command.

This is an example of the possible output.

```
rlghncxa03w 10-07-17 16:02:05 GMT EAGLE5 42.0.0

SCCP OPTIONS
-----
MTPRGTT                off
MTPRGTTFALLBK         mtproute
```

The `rtrv-sccpopts` output contains other fields that are not used in this procedure. If you wish to see these fields, refer to the `rtrv-sccpopts` command description in *Commands User's Guide*.

If the `MTPRGTT` value is either `usemtpgc` or `fullgtt`, or the `MTPRGTTFALLBK` value is `gttfail`, then either the MTP Routed GWS Stop Action feature or the MTP Msgs for SCCP Apps feature is enabled. The `MTPRGTT` or `MTPRGTTFALLBK` values can be changed. Continue the procedure with [3](#).

If the `MTPRGTT` value is `off` and the `MTPRGTTFALLBK` value is `mtproute`, continue the procedure with [2](#).

2. Display the status of the MTP Routed GWS Stop Action feature or the MTP Msgs for SCCP Apps features by entering the `rtrv-ctrl-feat` command.

This is an example of the possible output.

```
rlghncxa03w 10-07-07 00:29:31 GMT EAGLE5 42.0.0
```

The following features have been permanently enabled:

Feature Name	Partnum	Status	Quantity
Intermed GTT Load Sharing	893006901	on	----
SCCP Loop Detection	893016501	on	----
SCCP Conversion	893012001	off	----
HC-MIM SLK Capacity	893012707	on	64
Flexible GTT Load Sharing	893015401	on	----
Origin Based SCCP Routing	893014301	on	----
Hex digit support for GTT	893018501	on	----
AMGTT	893021801	on	----
MO SMS B-Party Routing	893024601	on	----
GTT Action - DISCARD	893027501	off	----
GTT Action - DUPLICATE	893027601	off	----
GTT Action - FORWARD	893037501	on	----
ANSI41 AIQ	893034901	off	----

The following features have been temporarily enabled:

Feature Name	Partnum	Status	Quantity	Trial Period
Left				

Zero entries found.

The following features have expired temporary keys:

Feature Name	Partnum
Zero entries found.	

If either the MTP Routed GWS Stop Action feature or the MTP Msgs for SCCP Apps features are enabled, continue the procedure with [3](#).

If neither the MTP Routed GWS Stop Action feature or the MTP Msgs for SCCP Apps features are enabled, enable the desired feature by performing one of these procedures.

- To enable the MTP Routed GWS Stop Action feature, perform the “Activating the MTP Routed GWS Stop Action Feature” procedure in *Database Administration GWS User's Guide*.
- To enable the MTP Msgs for SCCP Apps feature, perform the “MTP Msgs for SCCP Apps Activation Procedure” in one of these user's guides to enable the feature.
 - *A-Port User's Guide*
 - *IS41 GSM Migration User's Guide*
 - *MO SMS User's Guide*

After the desired feature has been enabled, continue the procedure with [3](#).

3. Change the MTP-routed GTT option values using the `chg-sccpopts` command and with either the `mtprggtt` or the `mtprggttfallbk` parameters, or both parameters.

For this example, enter this command.

```
chg-sccpopts:mtprggtt=fullgtt:mtprggttfallbk=gttfail
```

When the `chg-sccpopts` command has successfully completed, this message should appear.

```
rlghncxa03w 10-07-07 00:22:57 GMT EAGLE5 42.0.0  
CHG-STPOPTS: MASP A - COMPLTD
```

4. Verify the changes using the `rtrv-sccpopts` command. This is an example of the possible output.

```
rlghncxa03w 10-07-17 16:02:05 GMT EAGLE5 42.0.0
```

```
SCCP OPTIONS
```

```
-----  
MTPRGTT                fullgtt  
MTPRGTTFALLBK         gttfail
```

5. Back up the new changes using the `chg-db:action=backup:dest=fixed` command. These messages should appear, the active Maintenance and Administration Subsystem Processor (MASP) appears first.

```
BACKUP (FIXED) : MASP A - Backup starts on active MASP.  
BACKUP (FIXED) : MASP A - Backup on active MASP to fixed disk  
complete.  
BACKUP (FIXED) : MASP A - Backup starts on standby MASP.  
BACKUP (FIXED) : MASP A - Backup on standby MASP to fixed disk  
complete.
```

Figure 2-192 Change the MTP-Routed GTT Options

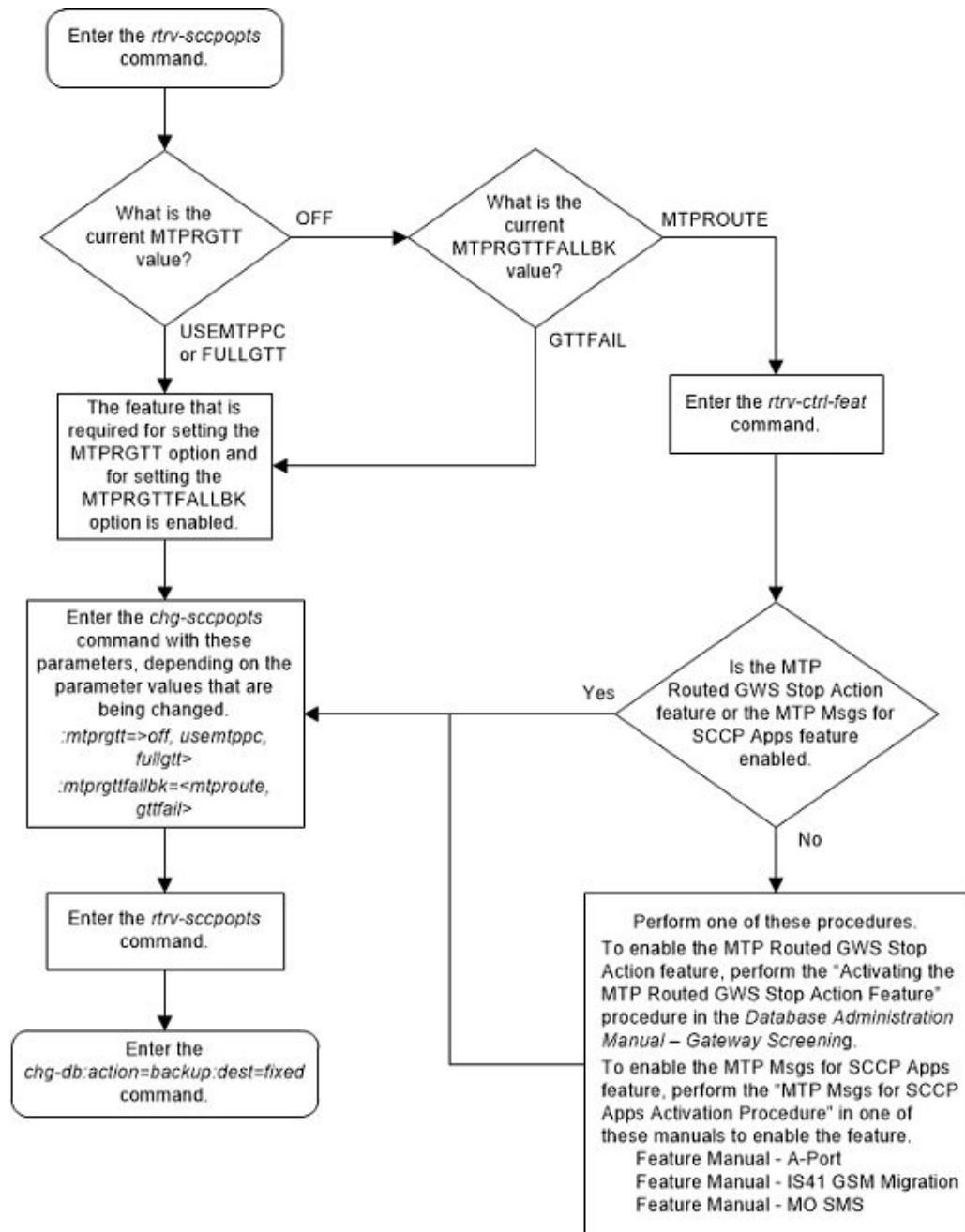

3

Global Title Translation (GTT) Configuration

Chapter 3, Global Title Translation (GTT) Configuration, contains the procedures specific to configure the global title translation feature.

Introduction

This chapter describes the procedures needed to add, remove, or change global title translation (GTT) data in the database

The items configured in this section are:

- Translation types
- Global title translations.

The following items must also be configured for the Global Title Translation feature. The procedures to configure these items are located in the [Global Title Translation \(GTT\) Overview](#) section.

- Service modules
- Translation type mapping
- Concerned signaling point codes
- Mate applications
- Mated relay node groups
- GT Conversion Table Entries for the ANSI/ITU SCCP Conversion feature.
- Loopsets for the SCCP Loop Detection feature.
- GT modification identifiers for the Advanced GT Modification feature.

The procedures shown in this chapter use a variety of commands. For more information on these commands, refer to *Commands User's Guide*.

 **Note:**

1. Before turning the Global Title Translation (GTT) feature on with the `chg-feat:gtt=on` command, make sure you have purchased this feature. If you are not sure whether you have purchased the GTT feature, contact your Oracle Sales Representative or Account Representative.
2. To perform the procedures in this chapter, the GTT feature must be on. The translation type (`ent-/dlt-/rtrv-tt`) and the GTT (`ent-/dlt-/chg-/rtrv-gtt`) commands can be executed when the EGTT feature is turned on, but will only produce CDGTA GTT sets and CDGTA GTT selectors. For more details on the EGTT feature, refer to the [Enhanced Global Title Translation \(EGTT\) Configuration](#) section.
3. To find out about the differences between the Global Title Translation (GTT) feature and the Enhanced Global Title Translation (EGTT) feature, refer to the [Upgrading from Global Title Translation \(GTT\) to Enhanced Global Title Translation \(EGTT\)](#) section.

Adding a Translation Type

This procedure is used to add a translation type to the database using the `ent-tt` command.

The `ent-tt` command uses these parameters.

`:type/typea/typei/typeis/typen/typens/typen24` – The translation type and network type of that translation type. The translation type indicates which global title translation table is to be used to determine the routing to a particular service database. The value of this parameter is from 0 to 255.

- `:type` or `::typea` – an ANSI network
- `:typei` – an ITU international network
- `:typeis` – an ITU international spare network
- `:typen` – a 14-bit ITU national network.
- `:typens` – a 14-bit ITU national spare network.
- `:typen24` – a 24-bit ITU national network.

`:ttn` – The name of the global title translation type, containing one alphabetic character and up to eight alphanumeric characters.

`:ndgt` – The number of digits, 1 to 21 digits, contained in the global title translation.

`:alias` – The alias of the global title translation type. The value of this parameter is from 0 to 255.

The translation type value, for example 10, can be specified as a value for each translation type parameter (`typea=10`, `typei=10`, `typeis=10`, `typen=10`, `typens=10`, `typen24=10`). The translation type value can appear in the `rtrv-tt` output only once for each network type of translation types.

An alias translation type value cannot be specified if the value is shown in the `TYPE` column of the `rtrv-tt` output for the network type defined by the specified translation

type parameter. For example, the alias translation type value 10 cannot be specified as an alias of an ITU-I translation type if a `TYPEI` value in the `rtrv-tt` output is 10. However, if the `TYPEIS` column does not contain the value 10, the value 10 can be specified as an alias translation type of an ITU-I spare translation type. The alias translation type value can appear in the `rtrv-tt` output only once for each network type of translation types.

When adding an alias translation type, the translation type must be specified with the `ent-tt` command. The translation type must be shown in the `rtrv-tt` output.

Either the `ndgt` parameter or the `alias` parameter can be specified with the `ent-tt` command, but not both at the same time.

The translation type name value specified with the `ent-tt` command cannot be shown in the `rtrv-tt` output.

This procedure can be performed if the EGTT feature is turned on. Only the CDGTA GTT sets and selectors (with the default values for the advanced parameters) are created. Adding a translation type when the EGTT feature is turned on creates a CDGTA GTT set. If the `type/typea` parameter is specified with the `ent-tt` command, the `NETDOM` value of the GTT set is ANSI. If the `typei`, `typeis`, `typen`, `typens`, or `typen24` parameter is specified with the `ent-tt` command, the `NETDOM` value of the GTT set is ITU. The `ttn` parameter value of the `ent-tt` command defines the name of the GTT set. If the `ttn` parameter is not specified with the `ent-tt` command, a default name for the GTT set is created. These are examples of the default GTT set names.

- If the ANSI translation type 10 is added, the GTT set name is `setans010`.
- If the ITU-I translation type 20 is added, the GTT set name is `setint020`.
- If the ITU-I spare translation type 5 is added, the GTT set name is `setins005`.
- If the ITU-N translation type 100 is added, the GTT set name is `setnat100`.
- If the ITU-N spare translation type 30 is added, the GTT set name is `setnas030`.
- If the ITU-N24 translation type 40 is added, the GTT set name is `set24n040`.

If the translation type is an ANSI translation type, one GTT selector associated with the CDGTA GTT set that contains the global title indicator value 2 and the translation type value is created. If the translation type is an ITU-I, ITU-I spare, ITU-N, ITU-N spare, or ITU-N24 translation type, two GTT selectors associated with the CDGTA GTT set are created. One GTT selector contains the global title indicator value 2 and the translation type value. The other GTT selector contains the global title indicator value 4 and the translation type value. The advanced GTT parameter values for these GTT selectors are set to these default values.

- `NP - dflt` - for ITU GTT selectors only. ANSI GTT selectors can only contain dashes in this column.
- `NAI - dflt` - for ITU GTT selectors only. ANSI GTT selectors can only contain dashes in this column.
- `CGSSN` - dashes
- `SELID` - none
- `LSN` - any

If a GTT set is in the database with the same name as the `ttn` parameter value or the default GTT set name, the translation type will not be added to the database.

The global title translation feature must be turned on. Verify this by entering the `rtrv-feat` command. If the global title translation feature is off, it can be turned on by entering the `chg-feat:gtt=on` command.

 **Note:**

Once the Global Title Translation (GTT) feature is turned on with the `chg-feat` command, it cannot be turned off.

The GTT feature must be purchased before turning it on. If you are not sure whether you have purchased the GTT feature, contact your Sales Representative or Account Representative.

If the Variable-length Global Title Translation Feature (VGTT) is on, shown by the entry `VGTT = on` in the `rtrv-feat` command output, or the Support for 16 GTT Lengths in VGTT feature is enabled and turned on, shown by the entry `VGTT with 16 Lengths` in the `rtrv-ctrl-feat` output, the `ndgt` parameter cannot be specified with the `ent-tt` command. The length of the global title address is determined when the global title address is entered with the `ent-gtt` command. If only the VGTT feature is on, the translation type can contain a maximum of ten different lengths of global title addresses. If the Support for 16 GTT Lengths in VGTT feature is enabled and turned on, the translation type can contain a maximum of 16 different lengths of global title addresses. For more information on the VGTT feature, the Support for 16 GTT Lengths in VGTT feature, and the length of global title addresses, refer to [Variable-length Global Title Translation Feature](#) and [Adding a Global Title Translation](#).

If the Variable-length Global Title Translation Feature (VGTT) is on, the `NDGT` field of the `rtrv-tt` command shows the different lengths of global title addresses assigned to a translation type, as shown in the following example.

```
rlghncxa03w 10-07-25 09:57:31 GMT EAGLE5 42.0.0
TYPEA      TTN      NDGT
1          lidb     6, 12, 15
2          c800    10
3          d700    6

ALIAS      TYPEA
50         3
65         3

TYPEI      TTN      NDGT
105       itudb    8

ALIAS      TYPEI
7         105

TYPEN      TTN      NDGT
120       dbitu    7

ALIAS      TYPEN
8         120

TYPEIS     TTN      NDGT
```

```

ALIAS      TYPEIS
TYPENS     TTN      NDGT
ALIAS      TYPENS

```

In this example of the `rtrv-tt` command output, the ANSI translation type 1 contains three different length global title addresses; global title addresses containing six digits, 12 digits, and 15 digits.

If the Variable-length Global Title Translation Feature (VGTT) feature is off and you wish to turn it on, enter the `chg-feat:vgtt=on` command. The GTT feature must be on before the `vgtt=on` parameter can be specified with the `chg-feat` command.

 **Note:**

Once the Variable-length Global Title Translation (VGTT) feature is turned on with the `chg-feat` command, it cannot be disabled. The VGTT feature must be purchased before turning it on. If you are not sure whether you have purchased the VGTT feature, contact your Sales Representative or Account Representative.

1. Verify that the GTT feature is on, by entering the `rtrv-feat` command. If the GTT feature is on, the `GTT` field should be set to `on`.

 **Note:**

The `rtrv-feat` command output contains other fields that are not used by this procedure. If you wish to see all the fields displayed by the `rtrv-feat` command, refer to the `rtrv-feat` command description in *Commands User's Guide*.

If the GTT feature is off, perform the [Adding a Service Module](#) procedure to turn the GTT feature on and to make sure that the correct hardware is installed. After the [Adding a Service Module](#) procedure has been performed, continue the procedure with [11](#).

If the GTT feature is on, continue the procedure by performing one of these steps.

- If the EGTT feature is on, continue the procedure with [3](#).
 - If the EGTT feature is off, continue the procedure with [2](#).
2. Display the translation types in the database using the `rtrv-tt` command. This is an example of the possible output.

```
rlghncxa03w 10-07-25 09:57:31 GMT EAGLE5 42.0.0
```

```

TYPEA      TTN      NDGT
1          lidb      5
2          c800     10

```



```

3          d700      6

ALIAS      TYPEA
50         3
65         3

TYPEI      TTN      NDGT
105       itudb     8

ALIAS      TYPEI
7         105

TYPEN      TTN      NDGT
120       dbitu     7

ALIAS      TYPEN
8         120

TYPEIS     TTN      NDGT

ALIAS      TYPEIS

TYPENS     TTN      NDGT

ALIAS      TYPENS

```

Continue the procedure with 6.

3. Display the GTT set by entering the `rtrv-gttset` command with the TTN value that will be assigned to the translation type for the `gttsn` parameter value.

For this example, enter these commands.

```
rtrv-gttset:gttsn=scp1
```

This is an example of the possible output.

```
rlghncxa03w 10-07-25 09:57:31 GMT EAGLE5 42.0.0
```

```

GTTSN      NETDOM  NDGT
scp1       ansi     6

```

GTT-SET table is (7 of 2000) 1% full.

```
rtrv-gttset:gttsn=scp2
```

This is an example of the possible output.

```
rlghncxa03w 10-07-25 09:57:31 GMT EAGLE5 42.0.0
```

```

GTTSN      NETDOM  NDGT
scp2       ansi     6

```

GTT-SET table is (7 of 2000) 1% full.

```
rtrv-gttset:gttsn=scp3
```

This is an example of the possible output.

```
rlghncxa03w 10-07-25 09:57:31 GMT EAGLE5 42.0.0
```

```
GTTSN      NETDOM  NDGT
scp3       ansi    6
```

```
GTT-SET table is (7 of 2000) 1% full.
```

This message is displayed if the specified GTT set is not in the database.

```
E3561 Cmd Rej: GTT Set specified by GTT Set Name/index does
not exist
```

If the TTN value is not the name of a GTT set, only a CDGTA GTT set whose NETDOM value is either ANSI or ITU can be provisioned in this procedure. The advanced GTT parameters for the GTT selector that is created in this procedure will be set to these default values.

- NP - dflt - for ITU GTT selectors only. ANSI GTT selectors can only contain dashes in this column.
- NAI - dflt - for ITU GTT selectors only. ANSI GTT selectors can only contain dashes in this column.
- CGSSN - dashes
- SELID - none
- LSN - any

If you wish to provision a GTT set that has a set type other than CDGTA or whose NETDOM value is CROSS, do not perform the remainder of this procedure. Perform the [Adding a GTT Set](#) procedure to add the GTT set.

If the GTT set will be a CDGTA GTT set whose NETDOM value is either ANSI or ITU, but the GTT selector that will be created will contain values for the advanced GTT parameters other than the default values, do not perform the remainder of this procedure. Perform the [Adding a GTT Selector](#) procedure to add the GTT selector.

If the GTT set will be a CDGTA GTT set whose NETDOM value is either ANSI or ITU, and the GTT selector that will be created will contain the default values for the advanced GTT parameters, continue the procedure with [6](#).

If the TTN value is the name of a GTT set, and the SETTYPE column is not shown in the rtrv-gttset output, the Origin-Based SCCP Routing or the Flexible Linkset Optional Based Routing features are not enabled. The GTT set shown in the rtrv-gttset output is a CDGTA GTT set. If the NETDOM value of the GTT set is either ANSI or ITU, continue the procedure with [4](#).

If the TTN value is the name of a GTT set, and the SETTYPE column is shown in the rtrv-gttset output, the Origin-Based SCCP Routing or the Flexible Linkset Optional Based Routing features are enabled. If the SETTYPE value of the GTT set is CDGTA and the NETDOM value of the GTT set is either ANSI or ITU, continue the procedure with [4](#).

If the SETTYPE value of the GTT set is a value other than CDGTA, or if the NETDOM value of the GTT set is CROSS, the TTN value cannot be used in this procedure. If you wish to use this procedure to add a GTT set, repeat this step with a different TTN value. If you wish to use the TTN value to add a GTT selector, perform the [Adding a GTT Selector](#) procedure.

4. Display the features that are enabled by entering the `rtrv-ctrl-feat` command.

The following is an example of the possible output.

```
rlghncxa03w 10-07-28 21:15:37 GMT EAGLE5 42.0.0
The following features have been permanently enabled:
```

Feature Name	Partnum	Status	Quantity
Command Class Management	893005801	on	----
LNP Short Message Service	893006601	on	----
Intermed GTT Load Sharing	893006901	on	----
HC-MIM SLK Capacity	893012707	on	64

The following features have been temporarily enabled:

Feature Name	Partnum	Status	Quantity	Trial
Period Left				
Zero entries found.				

The following features have expired temporary keys:

Feature Name	Partnum
Zero entries found.	

5. Display the GTT selectors in the database by entering the `rtrv-gttsel` command with the TTN value associated with the translation type that will be assigned to the global title translation. The TTN value is shown in the `rtrv-tt` output in [2](#).

To specify of the TTN value, the parameters shown in [Table 3-1](#) must be specified with the `rtrv-gttsel` command. The parameters that can be specified are dependent on the features that are enabled, shown in [4](#).

Table 3-1 RTRV-GTTSEL Parameters

Feature that is Enabled	Parameter that must be Specified for the TTN Value
Neither the Origin Based SCCP Routing nor the Flexible Linkset Optional Based Routing, shown as Flex Lset Optnl Based Rtg in the <code>rtrv-ctrl-feat</code> output, is enabled.	<code>gttsn</code>
Origin Based SCCP Routing	<code>cdgtasn, cggtsn</code>
Flexible Linkset Optional Based Routing	<code>cdgttsn, cggtsn</code>

For this example, enter these commands.

```
rtrv-gtttsel:gttsn=scp1
```

```
rlghncxa03w 10-07-28 21:15:37 GMT EAGLE5 42.0.0
```

```
GTIA   TT   NP   NAI  SELID GTTSN
  2     5   --   ---  none  scp1
GTII   TT   NP   NAI  SELID GTTSN

GTIN   TT   NP   NAI  SELID GTTSN

GTIN24 TT   NP   NAI  SELID GTTSN

GTIIS  TT   NP   NAI  SELID GTTSN

GTINS  TT   NP   NAI  SELID GTTSN
```

```
rtrv-gtttsel:gttsn=scp2
```

```
rlghncxa03w 10-07-28 21:15:37 GMT EAGLE5 42.0.0
```

```
GTIA   TT   NP   NAI  SELID GTTSN
  2    10  --   ---  none  scp2
GTII   TT   NP   NAI  SELID GTTSN

GTIN   TT   NP   NAI  SELID GTTSN

GTIN24 TT   NP   NAI  SELID GTTSN

GTIIS  TT   NP   NAI  SELID GTTSN

GTINS  TT   NP   NAI  SELID GTTSN
```

```
rtrv-gtttsel:gttsn=scp1
```

```
rlghncxa03w 10-07-28 21:15:37 GMT EAGLE5 42.0.0
```

```
GTIA   TT   NP   NAI  SELID GTTSN
  2    15  --   ---  none  scp3
GTII   TT   NP   NAI  SELID GTTSN

GTIN   TT   NP   NAI  SELID GTTSN

GTIN24 TT   NP   NAI  SELID GTTSN

GTIIS  TT   NP   NAI  SELID GTTSN

GTINS  TT   NP   NAI  SELID GTTSN
```

If no entries are displayed for the TTN value, continue the procedure with [6](#).

If any of the entries shown in the `rtrv-gtttsel` output do not have the default values for the advanced GTT parameters, or if a GTT selector entry with the TTN value was removed with the `dlt-gtttsel` command, the remainder of

this procedure cannot be performed. Choose another translation type and TTN combination and repeat this procedure from 5.

If all of the entries shown in the `rtrv-gttsel` output have the default values for the advanced GTT parameters; none of the GTT selector entries with the TTN value were removed with the `dlt-gttsel` command; and none of the entries contain the translation type value that will be specified in 11, continue the procedure with 6.

If any of the entries contain the translation type value that will be specified in 11, and you wish to specify an alias translation type to the translation type entry using this procedure, continue the procedure with 11. If you do not wish to specify an alias translation type to the translation type entry using this procedure, do not perform the remainder of this procedure. Perform the [Adding a GTT Selector](#) procedure to add the GTT selector.

6. Continue the procedure by performing one of these steps.
 - If multiple values are shown in the `NDGT` column for any translation type entry, the Variable-Length Global Title Translation feature is turned on. If a translation type entry contains 11 - 16 values in the `NDGT` column, the Support for 16 GTT Lengths in VGTT feature is enabled and turned on.
 - If no more than 10 values are shown in the `NDGT` column for any translation type, continue the procedure by performing one of these steps.
 - * If the new translation type that is being added will contain no more than 10 different length global title addresses, continue the procedure with 11.
 - * If the new translation type that is being added will contain more than 10 different length global title addresses, continue the procedure with 10.
 - If more than 10 values are shown in the `NDGT` column for any translation type, continue the procedure with 11.
 - If only single values are shown in the `NDGT` column for all the translation type entries, continue the procedure by performing one of these steps.
 - If the new translation type that is being added will contain global title addresses of only one length, continue the procedure with 11.
 - If the new translation type that is being added will contain multiple lengths of global title addresses, continue the procedure with 7.
7. Verify that the VGTT feature is on, by entering the `rtrv-feat` command. If the VGTT feature is on, the `VGTT` field should be set to `on`.

 **Note:**

The `rtrv-feat` command output contains other fields that are not used by this procedure. If you wish to see all the fields displayed by the `rtrv-feat` command, see the `rtrv-feat` command description in *Commands User's Guide*.

Continue the procedure by performing one of these steps.

- If the VGTT feature is on, continue the procedure by performing one of these steps.
 - If the new translation type that is being added will contain no more than 10 different length global title addresses, continue the procedure with 11.
 - If the new translation type that is being added will contain more than 10 different length global title addresses, continue the procedure with 10.
 - If the VGTT feature is off, continue the procedure with 8.
8. Display the cards in the EAGLE 5 using the `rtrv-card` command. This is an example of the possible output.

```
rlghncxa03w 13-05-25 09:58:31 GMT EAGLE5 45.0.0
CARD   TYPE      APPL      LSET NAME      LINK SLC LSET NAME
LINK SLC
1102   TSM           GLS
1113   E5MCAP        EOAMHC
1114   E5TDM-A
1115   E5MCAP        EOAMHC
1116   E5TDM-B
1117   E5MDAL
1118   RESERVED
1201   LIMDS0        SS7ANSI   sp2             A    0    sp1
B      0
1203   LIMDS0        SS7ANSI   sp3             A    0
1204   LIMDS0        SS7ANSI   sp3             A    1
1206   LIMDS0        SS7ANSI   nsp3            A    1    nsp4
B      1
1308   LIMDS0        SS7ANSI   sp6             A    1    sp7
B      0
1314   LIMDS0        SS7ANSI   sp7             A    1    sp5
B      1
```

The correct service modules must be in the EAGLE before the VGTT feature can be turned on, or the Support for 16 GTT Lengths in VGTT feature can be enabled and turned on. See [Adding a Service Module](#) to determine the service modules that are required. If any service modules must be replaced, contact the Customer Care Center before replacing any service modules. Refer to [My Oracle Support \(MOS\)](#) for the contact information.

9. Turn the Variable-length Global Title Translation (VGTT) feature on by entering this command.

```
chg-feat:vgtt=on
```

 **Note:**

Once the Variable-length Global Title Translation (VGTT) feature is enabled with the `chg-feat` command, it cannot be disabled. The VGTT feature must be purchased before turning it on. If you are not sure whether you have purchased the VGTT feature, contact your Sales Representative or Account Representative.

When the `chg-feat` has successfully completed, this message should appear.

```
rlghncxa03w 09-05-25 09:57:41 GMT EAGLE5 41.0.0  
CHG-FEAT: MASP A - COMPLTD
```

Continue the procedure by performing one of these steps.

- If the new translation type that is being added will contain no more than 10 different length global title addresses, continue the procedure with [11](#).
- If the new translation type that is being added will contain more than 10 different length global title addresses, perform [Activating the Support for 16 GTT Lengths in VGTT Feature](#) to enable and turn on the Support for 16 GTT Lengths in VGTT feature. After the Support for 16 GTT Lengths in VGTT feature has been enabled and turned on, continue the procedure with [11](#).

10. Display the status of the Support for 16 GTT Lengths in VGTT feature by entering this command.

```
rtrv-ctrl-feat:partnum=893024801
```

```
rlghncxa03w 09-05-25 09:57:41 GMT EAGLE5 41.0.0  
The following features have been permanently enabled:
```

Feature Name	Partnum	Status	Quantity
VGTT with 16 GTT lengths	893024801	on	----

The following features have been temporarily enabled:

Feature Name	Partnum	Status	Quantity	Trial Period
Left				

Zero entries found.

The following features have expired temporary keys:

Feature Name	Partnum
Zero entries found.	

If the Support for 16 GTT Lengths in VGTT feature is enabled and turned on, continue the procedure with [11](#).

If the Support for 16 GTT Lengths in VGTT feature is not enabled or turned on, perform [Activating the Support for 16 GTT Lengths in VGTT Feature](#) to enable and turn on the Support for 16 GTT Lengths in VGTT feature. After the Support for 16 GTT Lengths in VGTT feature has been enabled and turned on, continue the procedure with [11](#).

11. Add the translation type to the database using the `ent-tt` command. For this example, enter these commands.

 **Note:**

If the VGTT feature is on, or the Support for 16 GTT Lengths in VGTT feature is enabled and turned on, the `ndgt` parameter cannot be specified with the `ent-tt` command.

```
ent-tt:typepa=5:ttn=scp1
ent-tt:typepa=10:ttn=scp2
ent-tt:typepa=15:ttn=scp3
ent-tt:typepa=5:ttn=scp1:alias=30
ent-tt:typepa=10:ttn=scp2:alias=40
```

Notes:

- a. If the VGTT feature is on, the `ndgt` parameter cannot be specified with the `ent-tt` command.
- b. The translation type value, for example 10, can be specified as a value for each translation type parameter (`typepa=10`, `typepi=10`, `typepis=10`, `typen=10`, `typens=10`, `typen24=10`). The translation type value can appear in the `rtrv-tt` output only once for each network type of translation types.
- c. An alias translation type value cannot be specified if the value is shown in the `TYPE` column of the `rtrv-tt` output for the network type defined by the specified translation type parameter. For example, the alias translation type value 10 cannot be specified as an alias of an ITU-I translation type if a `TYPEPI` value in the `rtrv-tt` output is 10. However, if the `TYPEIS` column does not contain the value 10, the value 10 can be specified as an alias translation type of an ITU-I spare translation type. The alias translation type value can appear in the `rtrv-tt` output only once for each network type of translation types.
- d. When adding an alias translation type, the translation type must be specified with the `ent-tt` command. The translation type must be shown in the `rtrv-tt` output.
- e. If the `ttn` parameter is not specified, the `ttn` value will be added in the formats shown in this list.
 - If an ANSI translation type 10 is specified, the `ttn` value will be `setans010`.
 - If an ITU-I translation type 10 is specified, the `ttn` value will be `setint010`.
 - If an ITU-I spare translation type 10 is specified, the `ttn` value will be `setins010`.
 - If an ITU-N translation type 10 is specified, the `ttn` value will be `setnat010`.
 - If an ITU-N spare translation type 10 is specified, the `ttn` value will be `setnas010`.
 - If an ITU-N24 translation type 10 is specified, the `ttn` value will be `set24n010`.

When each of these commands have successfully completed, this message should appear.

```
rlghncxa03w 09-05-25 09:57:41 GMT EAGLE5 41.0.0  
ENT-TT: MASP A - COMPLTD
```

12. Verify the changes using the `rtrv-tt` command with the translation type value specified in 11. For this example, enter these commands.

```
rtrv-tt:typea=5
```

This is an example of the possible output.

```
rlghncxa03w 10-07-25 09:57:51 GMT EAGLE5 42.0.0
```

```
TYPEA      TTN      NDGT  
5          scp1     6
```

```
ALIAS      TYPEA  
30         5
```

```
rtrv-tt:typea=10
```

This is an example of the possible output.

```
rlghncxa03w 10-07-25 09:57:51 GMT EAGLE5 42.0.0
```

```
TYPEA      TTN      NDGT  
10         scp2     6
```

```
ALIAS      TYPEA  
40         10
```

```
rtrv-tt:typea=15:ttn=scp3
```

This is an example of the possible output.

```
rlghncxa03w 10-07-25 09:57:51 GMT EAGLE5 42.0.0
```

```
TYPEA      TTN      NDGT  
15         scp3     3
```

```
ALIAS      TYPEA
```

13. Backup the new changes using the `chg-db:action=backup:dest=fixed` command. These messages should appear, the active Maintenance and Administration Subsystem Processor (MASP) appears first.

```
BACKUP (FIXED) : MASP A - Backup starts on active MASP.  
BACKUP (FIXED) : MASP A - Backup on active MASP to fixed disk  
complete.  
BACKUP (FIXED) : MASP A - Backup starts on standby MASP.  
BACKUP (FIXED) : MASP A - Backup on standby MASP to fixed disk  
complete.
```

Figure 3-1 Add a Translation Type - Sheet 1 of 6

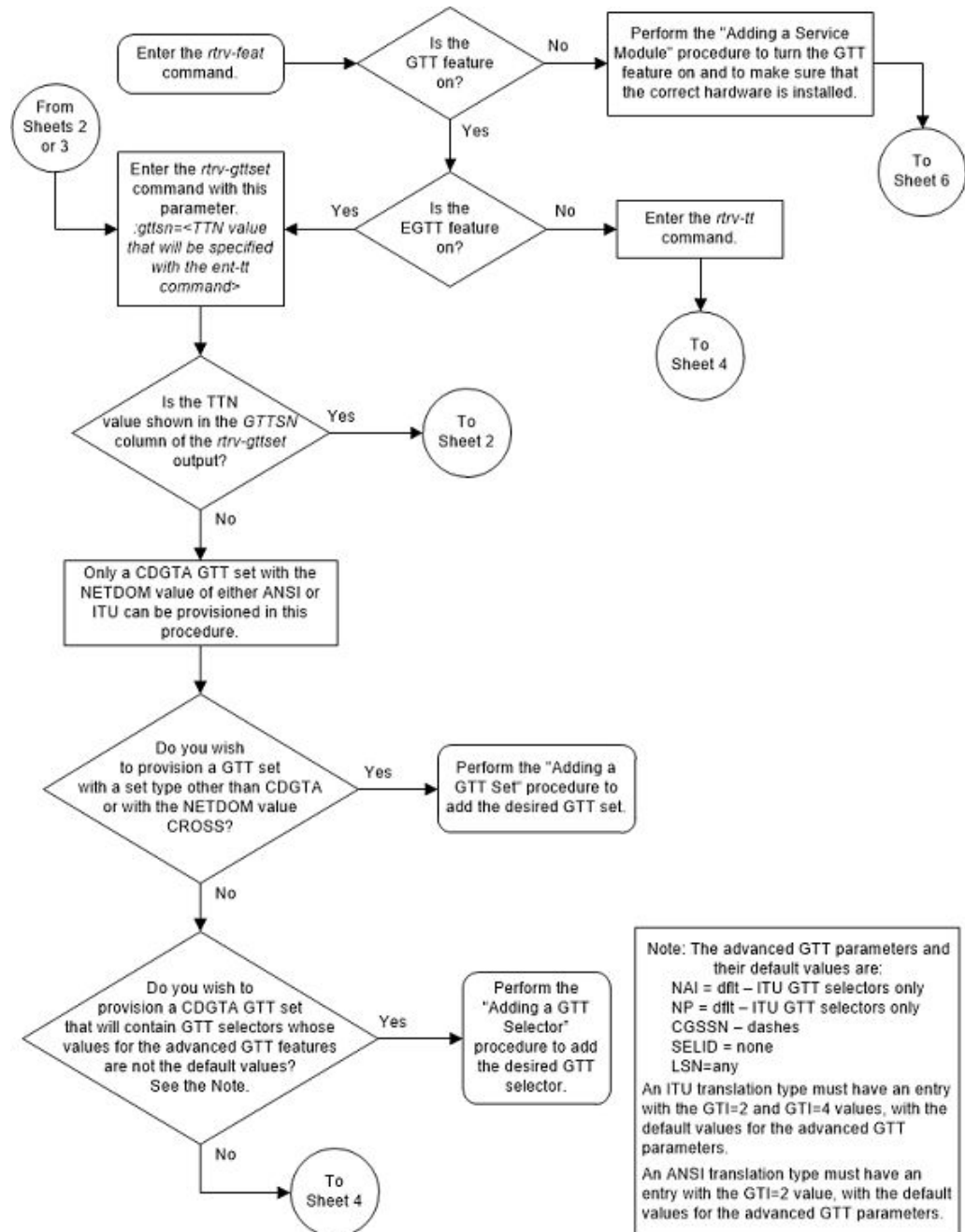

Figure 3-2 Add a Translation Type - Sheet 2 of 6

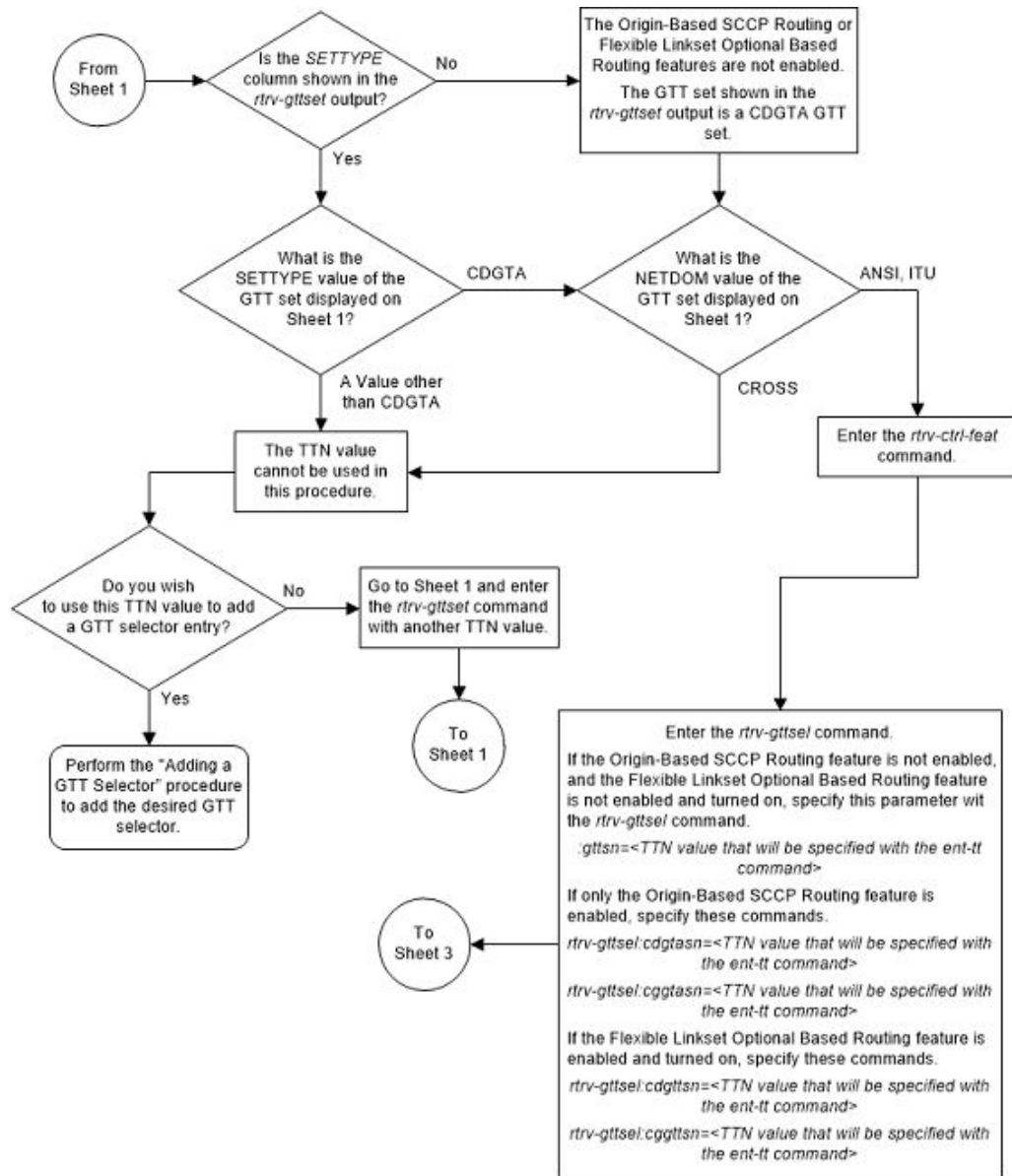

Figure 3-3 Add a Translation Type - Sheet 3 of 6

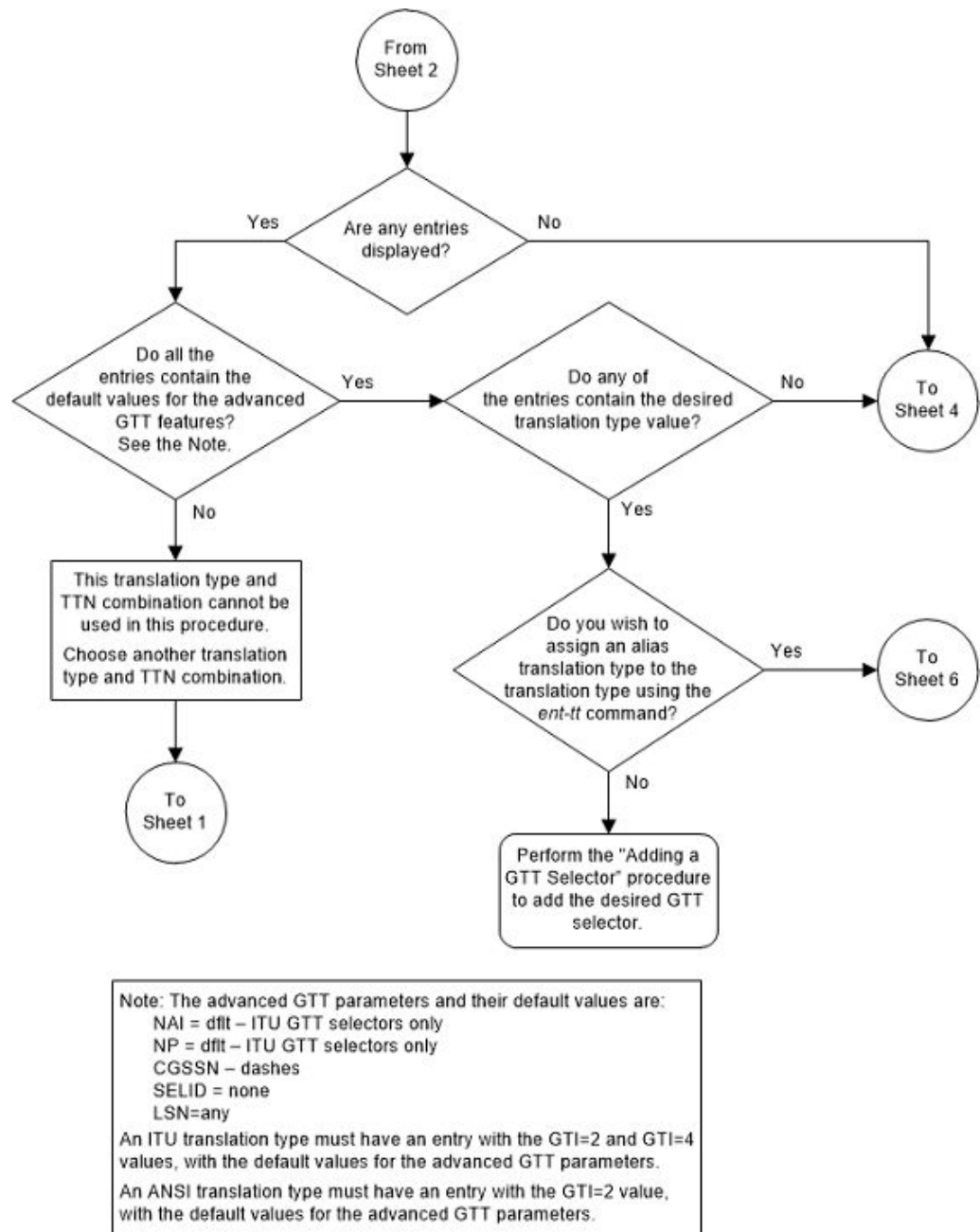

Figure 3-4 Add a Translation Type - Sheet 4 of 6

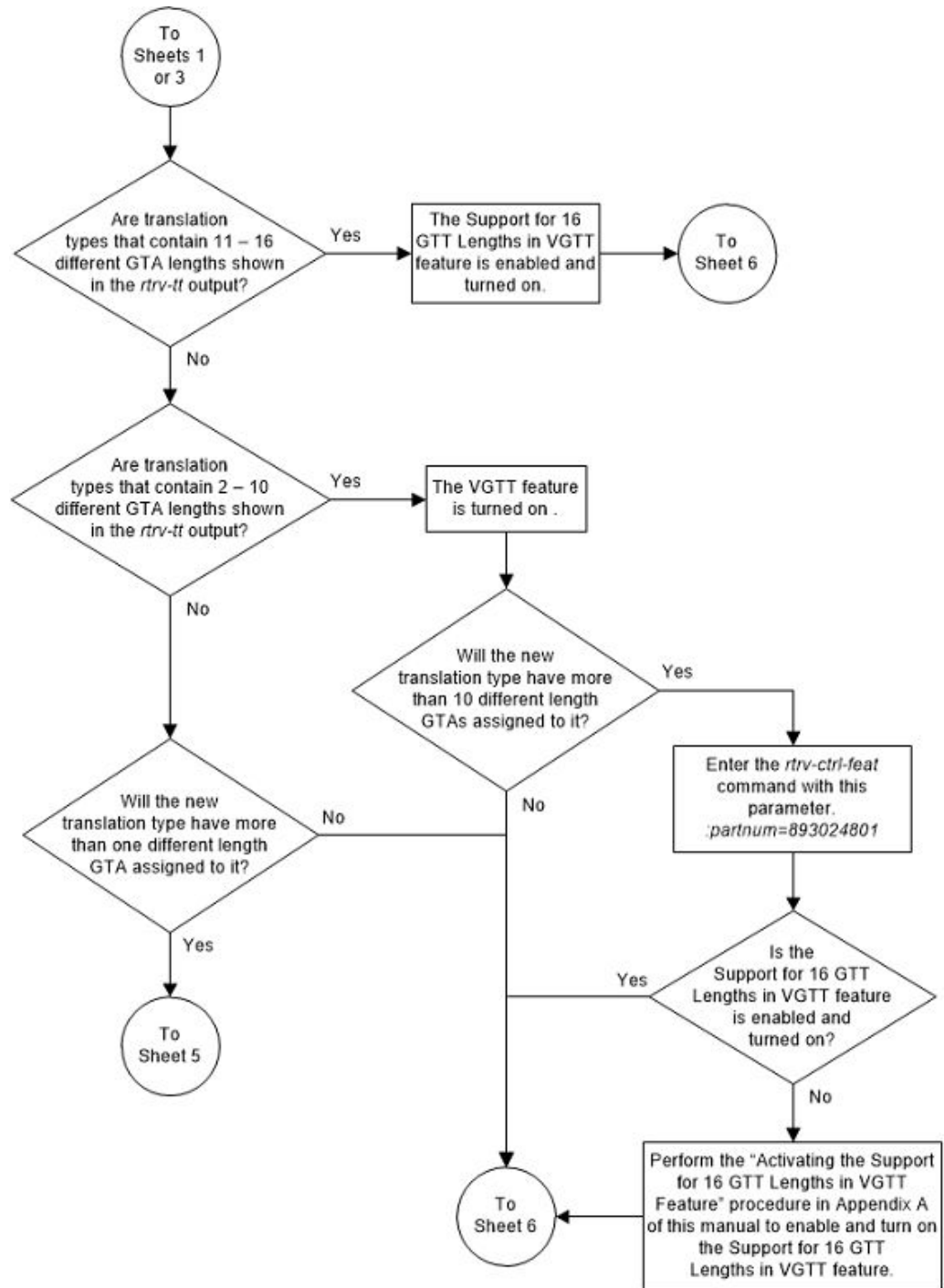

Figure 3-5 Add a Translation Type - Sheet 5 of 6

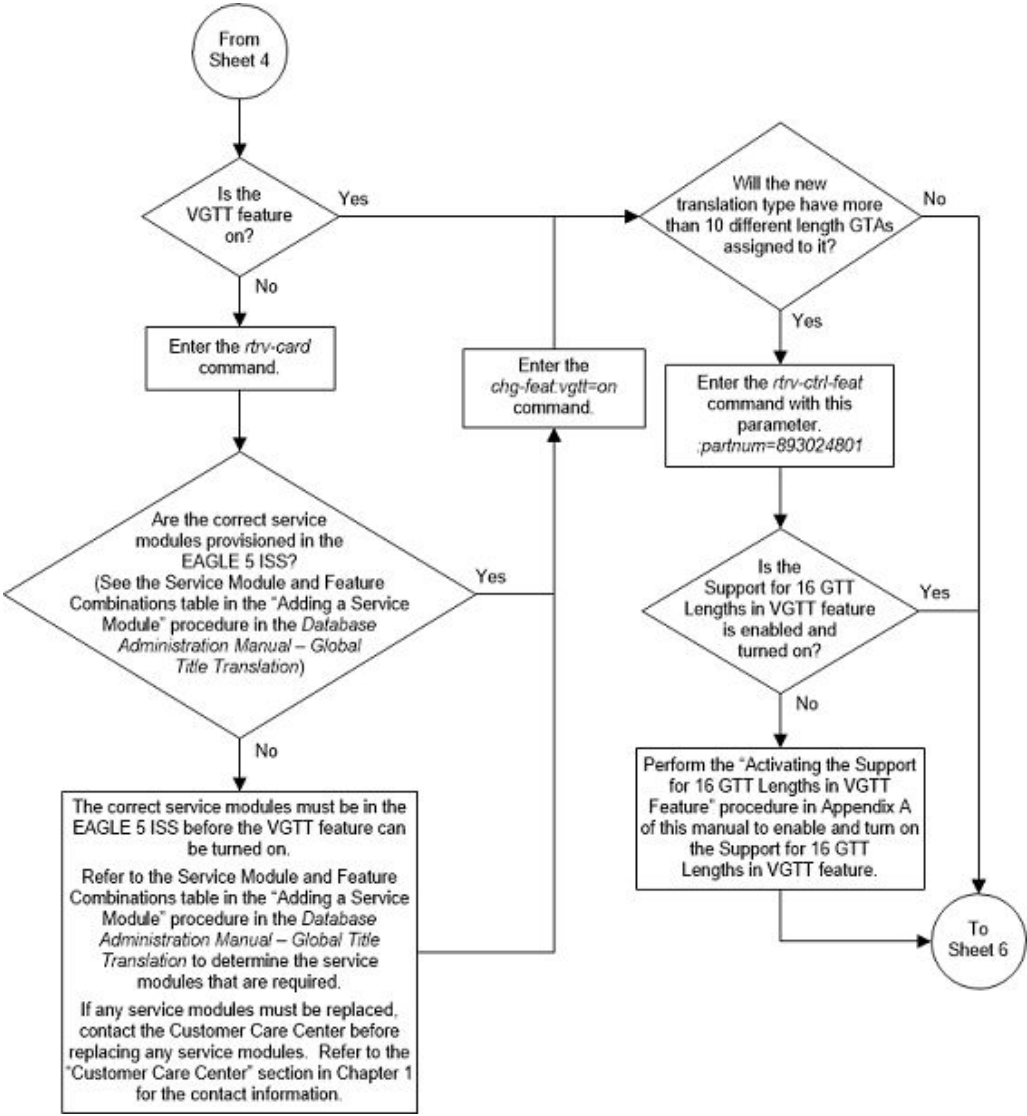
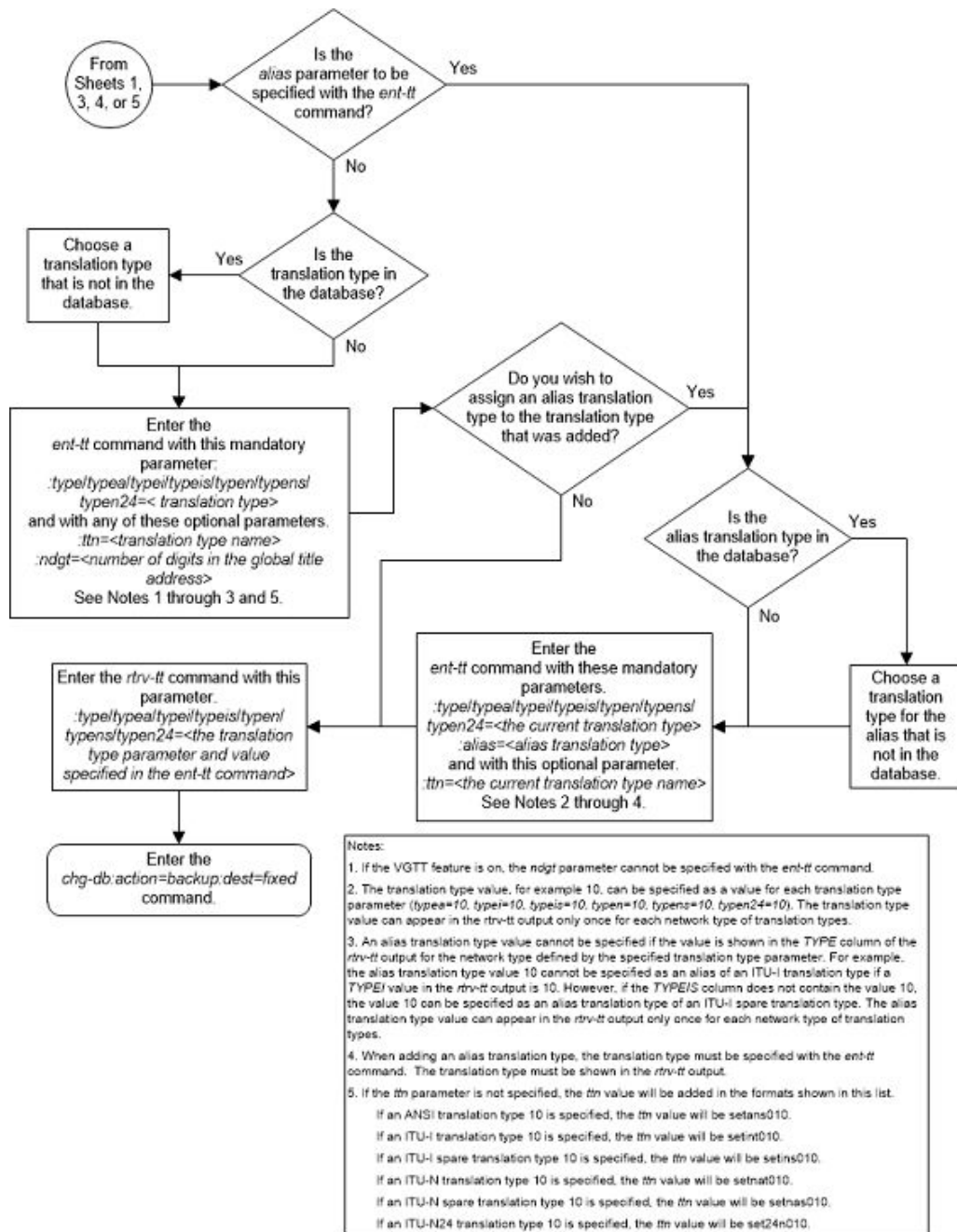

Figure 3-6 Add a Translation Type - Sheet 6 of 6



Removing a Translation Type

This procedure is used to remove a translation type from the database using the `dlt-tt` command.

The `dlt-tt` command uses these parameters.

`:type/typea/typei/typeis/typen/typens/typen24` – The translation type and network type of that translation type. The translation type indicates which global

title translation table is to be used to determine the routing to a particular service database.

- `:type` or `:typea` – an ANSI network
- `:typei` – an ITU international network
- `:typeis` – an ITU international spare network
- `:typen` – a 14-bit ITU national network.
- `:typens` – a 14-bit ITU national spare network.
- `:typen24` – a 24-bit ITU national network.

`:ttn` – The name of the global title translation type

`:alias` – The alias of the global title translation type

The examples in this procedure are used to remove the translation type 3 from the database.

The translation type, translation type name, or alias specified with the `dlt-tt` command must be shown in the `rtrv-tt` output, and must be assigned to the specified translation type

The translation type cannot be removed if the global title translation tables reference the translation type. Verify that the global title translation tables do not reference the translation type using the `rtrv-gtt` command.

If the `rtrv-gtt` command shows references to the translation type to be removed, go to the [Removing a Global Title Translation](#) procedure and remove the global title translation data associated with the translation type.

If the translation type is referenced by an alias, all aliases to the translation type must be removed first. To remove the alias, the alias and translation type must be specified in the `dlt-tt` command.

This procedure can be performed if the EGTT feature is turned on. If the EGTT feature is turned on, these rules apply.

1. The `dlt-tt` command removes the GTT selectors defined by the translation type that is specified with the `dlt-tt` command. If the `ttn` and `tt` parameters are specified with the `dlt-tt` command, the GTT selectors that are associated with the GTT set name that is defined by the `ttn` parameter value are removed. When the last GTT selector that is associated with a GTT set is removed with the `dlt-tt` command, the GTT set is removed. The GTT selectors are shown in the `rtrv-gttset` output and the GTT sets are shown in the `rtrv-gttset` output.
2. The GTT set that is associated with GTT selectors that are being removed can not be referenced by any GTA entry, shown in the `rtrv-gta` output, and cannot be referenced in any other GTT selector.
3. The GTT selectors that can be removed using the `dlt-tt` command can be associated only with CDGTA GTT sets.
4. To remove an ITU GTT selector is removed using the `dlt-tt` command, there must be entries in the database that contain the global title indicator values 2 and 4, along with the specified translation type value, and the translation type name value (this is the GTT set name) if the `ttn` parameter is specified. To remove a GTT selector using the `dlt-tt` command, these columns of the GTT selector entries must contain these values.

- NP - `df1t` - for ITU GTT selectors only. ANSI GTT selectors can only contain dashes in this column.
- NAI - `df1t` - for ITU GTT selectors only. ANSI GTT selectors can only contain dashes in this column.
- CGSSN - dashes
- SELID - none
- LSN - any

Canceling the `RTRV-GTT` Command

Because the `rtrv-gtt` command used in this procedure can output information for a long period of time, the `rtrv-gtt` command can be canceled and the output to the terminal stopped. There are three ways that the `rtrv-gtt` command can be canceled.

- Press the `F9` function key on the keyboard at the terminal where the `rtrv-gtt` command was entered.
- Enter the `canc-cmd` without the `trm` parameter at the terminal where the `rtrv-gtt` command was entered.
- Enter the `canc-cmd:trm=<xx>`, where `<xx>` is the terminal where the `rtrv-gtt` command was entered, from another terminal other than the terminal where the `rtrv-gtt` command was entered. To enter the `canc-cmd:trm=<xx>` command, the terminal must allow Security Administration commands to be entered from it and the user must be allowed to enter Security Administration commands. The terminal's permissions can be verified with the `rtrv-secu-trm` command. The user's permissions can be verified with the `rtrv-user` or `rtrv-secu-user` commands.

For more information about the `canc-cmd` command, go to *Commands User's Guide*.

1. Verify that the GTT feature is on, by entering the `rtrv-feat` command. If the GTT feature is on, the `GTT` field should be set to `on`.

Note:

The `rtrv-feat` command output contains other fields that are not used by this procedure. If you wish to see all the fields displayed by the `rtrv-feat` command, refer to the `rtrv-feat` command description in *Commands User's Guide*.

If the GTT feature is off, this procedure cannot be performed.

If the GTT feature is on, continue the procedure with [2](#).

2. Display the translation types in the database using the `rtrv-tt` command.

This is an example of the possible output.

```
rlghncxa03w 10-07-25 09:57:31 GMT EAGLE5 42.0.0
```

TYPEA	TTN	NDGT
1	lidb	5

```

2          c800      10
5          scp1      6
10         scp2      6
15         scp3      3

ALIAS      TYPEA
30         5
40         10

TYPEI      TTN      NDGT
3          d700     6
105       itudb    8

ALIAS      TYPEI
7          105
50         3
65         3

TYPEN      TTN      NDGT
120       dbitu    7

ALIAS      TYPEN
8          120

TYPEN24    TTN      NDGT

ALIAS      TYPEN24

TYPEIS     TTN      NDGT

ALIAS      TYPEIS

TYPENS     TTN      NDGT

ALIAS      TYPENS

```

If the translation type that is being removed contains an alias translation type and the alias translation type is being removed, continue the procedure with 8.

If the translation type does not contain an alias translation type or if an alias translation type is not being removed, continue the procedure by performing one of these steps.

- If the EGTT feature is not on, continue the procedure with 7.
 - If the EGTT feature is on, continue the procedure with 3.
3. Display the GTT set by entering the `rtrv-gttset` command with the TTN value that is assigned to the translation type for the `gttsn` parameter value.

For this example, enter this command.

```
rtrv-gttset:gttsn=d700
```

This is an example of the possible output.

```
rlghncxa03w 10-07-11 18:54:54 GMT EAGLE5 42.0.0
```

```
GTTSN      NETDOM  SETTYPE  NDGT
d700      itu      CDGTA    6
```

GTT-SET table is (8 of 2000) 1% full.

If the NETDOM value of the GTT set is CROSS, the translation type cannot be removed with this procedure. Perform the [Removing a GTT Selector](#) procedure to remove the translation type.

If the NETDOM value is ANSI or ITU, continue the procedure by performing one of these steps.

- If the SETTYPE column is not shown in the `rtrv-gttset` output, continue the procedure with [5](#).
 - If the SETTYPE column is shown in the `rtrv-gttset` output, continue the procedure with [4](#).
4. Display the features that are enabled by entering the `rtrv-ctrl-feat` command.

The following is an example of the possible output.

```
rlghncxa03w 10-07-28 21:15:37 GMT EAGLE5 42.0.0
The following features have been permanently enabled:
```

Feature Name	Partnum	Status	Quantity
Command Class Management	893005801	on	----
LNP Short Message Service	893006601	on	----
Intermed GTT Load Sharing	893006901	on	----
HC-MIM SLK Capacity	893012707	on	64

The following features have been temporarily enabled:

Feature Name	Partnum	Status	Quantity	Trial
Period Left				
Zero entries found.				

The following features have expired temporary keys:

Feature Name	Partnum
Zero entries found.	

5. Display the GTT selectors in the database by entering the `rtrv-gttset` command with the `tt` parameter and with one of these parameters.
- `gttsn`
 - `cdgtasn`
 - `cggtasn`
 - `cdgttsn`
 - `cggttsn`

The value that must be specified for the parameter in the previous list that will be specified with the `rtrv-gttset` command is the GTTSN value specified in [3](#). The parameter that must be specified for the TTN value is dependent on the feature

that is enabled as shown in [Table 3-2](#). The features that are enabled are shown in [4](#).

Table 3-2 RTRV-GTTSEL GTT Set Name Parameters

Feature that is Enabled	Parameter that must be Specified for the TTN Value
No feature is enabled, the SETTYPE column is not shown in the <code>rtrv-gttset</code> output	<code>gttsn</code>
Origin Based SCCP Routing	<code>cdgtasn, cggtnsn</code>
Flexible Linkset Optional Based Routing, shown as Flex Lset Optnl Based Rtg in the <code>rtrv-ctrl-feat</code> output	<code>cdgttsn, cggtsn</code>

If the Origin Based SCCP Routing or Flexible Linkset Optional Based Routing features are enabled, enter the `rtrv-gttset` command with each parameter shown in [Table 3-2](#).

For this example, enter this command.

```
rtrv-gttset:gttsn=d700:tt=3
```

This is an example of the possible output.

```
tekelecstp 10-07-11 20:08:02 EST 42.0.0

GTIA   TT     NP     NAI   SELID GTTSN
GTII   TT     NP     NAI   SELID GTTSN
  2     3     --     ---  none  d700
  4     3     dflt   dflt none  d700

GTIN   TT     NP     NAI   SELID GTTSN
GTIN24 TT     NP     NAI   SELID GTTSN
GTIIS  TT     NP     NAI   SELID GTTSN
GTINS  TT     NP     NAI   SELID GTTSN
```

If no entries are displayed, continue the procedure with [6](#).

If entries are displayed, continue the procedure by performing one of these steps.

- If any of the entries shown in the `rtrv-gttset` output do not have the default values for the advanced GTT parameters, or if a GTT selector entry with the TTN value was removed with the `dlt-gttset` command, the remainder of this procedure cannot be performed. Perform the [Removing a GTT Selector](#) procedure to remove the entry.
- If all of the entries shown in the `rtrv-gttset` output have the default values for the advanced GTT parameters, and none of the GTT selector entries with the TTN value were removed with the `dlt-gttset` command, continue the procedure with [6](#).

The default values for the advanced GTT parameters are shown in this list.

- NP - `df1t` - for ITU GTT selectors only. ANSI GTT selectors can only contain dashes in this column.
 - NAI - `df1t` - for ITU GTT selectors only. ANSI GTT selectors can only contain dashes in this column.
 - CGSSN - dashes
 - SELID - none
 - LSN - any
6. Display the GTA entries that reference the TTN value of the translation type by entering the `rtrv-gta` command with the TTN value for the `gttsn` parameter value.

For this example, enter this command.

```
rtrv-gta:gttsn=d700
```

This is an example of the possible output.

```
tekelecstp 10-07-12 07:48:31 EST 42.0.0

GTTSN      NETDOM  SETTYPE  NDGT
d700       itu     CDGTA    6

GTA table is (1 of 269999) 1% full.

START GTA  END GTA   XLAT   RI     ITU PC
919460    919460   DPC    SSN    2-002-2
          SSN=--- CCGT=no  CGGTMOD=NO
          GTMODID=----- TESTMODE=off
          OPTSN=----- CGSELID=----- OPCS=-----
          ACTSN=----- PPMEASREQD= NO
```

Command Retrieved 1 Entries

If entries are not displayed in this step, continue the procedure with 8.

If entries are displayed in this step, perform the [Removing Global Title Address Information](#) procedure to remove the displayed entries. When all the entries have been removed, continue the procedure with 8.

7. Display the global title translations assigned to the translation type being removed from the database using the `rtrv-gtt` command specifying the translation type being removed from the `rtrv-tt` command output shown in 2. For this example, enter this command.

```
rtrv-gtt:typei=3
```

This is an example of the possible output.

```
rlghncxa03w 10-07-25 09:46:31 GMT EAGLE5 42.0.0
TYPEI  TTN      NDGT
3      d700    6

GTT TABLE IS 10 % FULL (27000 of 269999)

START GTA          END GTA          XLAT  RI     ITU PC
```

```
910460          919460          NGT   GT   3-007-5
          SSN=----  GTMODID=-----
```

Command Retrieved 1 Entries

If global title translations are shown in the output of the `rtrv-gtt` command output, go to the [Removing a Global Title Translation](#) procedure and remove these global title translations.

8. Remove the translation type from the database using the `dlt-tt` command.

For this example, enter these commands.

```
dlt-tt:typepi=3:alias=50
```

```
dlt-tt:typepi=3:alias=65
```

```
dlt-tt:typepi=3
```

When each of these commands have successfully completed, this message should appear.

```
rlghncxa03w 07-05-25 09:57:41 GMT  EAGLE5 37.0.0
DLT-TT: MASP A - COMPLTD
```

9. Verify the changes using the `rtrv-tt` command and specify the translation type used in 8.

For this example, enter the `rtrv-tt:typea=3` command.

This message should appear.

```
E2466 Cmd Rej: Translation TYPE specified does not exist
```

10. Backup the new changes using the `chg-db:action=backup:dest=fixed` command.

These messages should appear, the active Maintenance and Administration Subsystem Processor (MASP) appears first.

```
BACKUP (FIXED) : MASP A - Backup starts on active MASP.
BACKUP (FIXED) : MASP A - Backup on active MASP to fixed disk
complete.
BACKUP (FIXED) : MASP A - Backup starts on standby MASP.
BACKUP (FIXED) : MASP A - Backup on standby MASP to fixed disk
complete.
```

Figure 3-7 Remove a Translation Type - Sheet 1 of 4

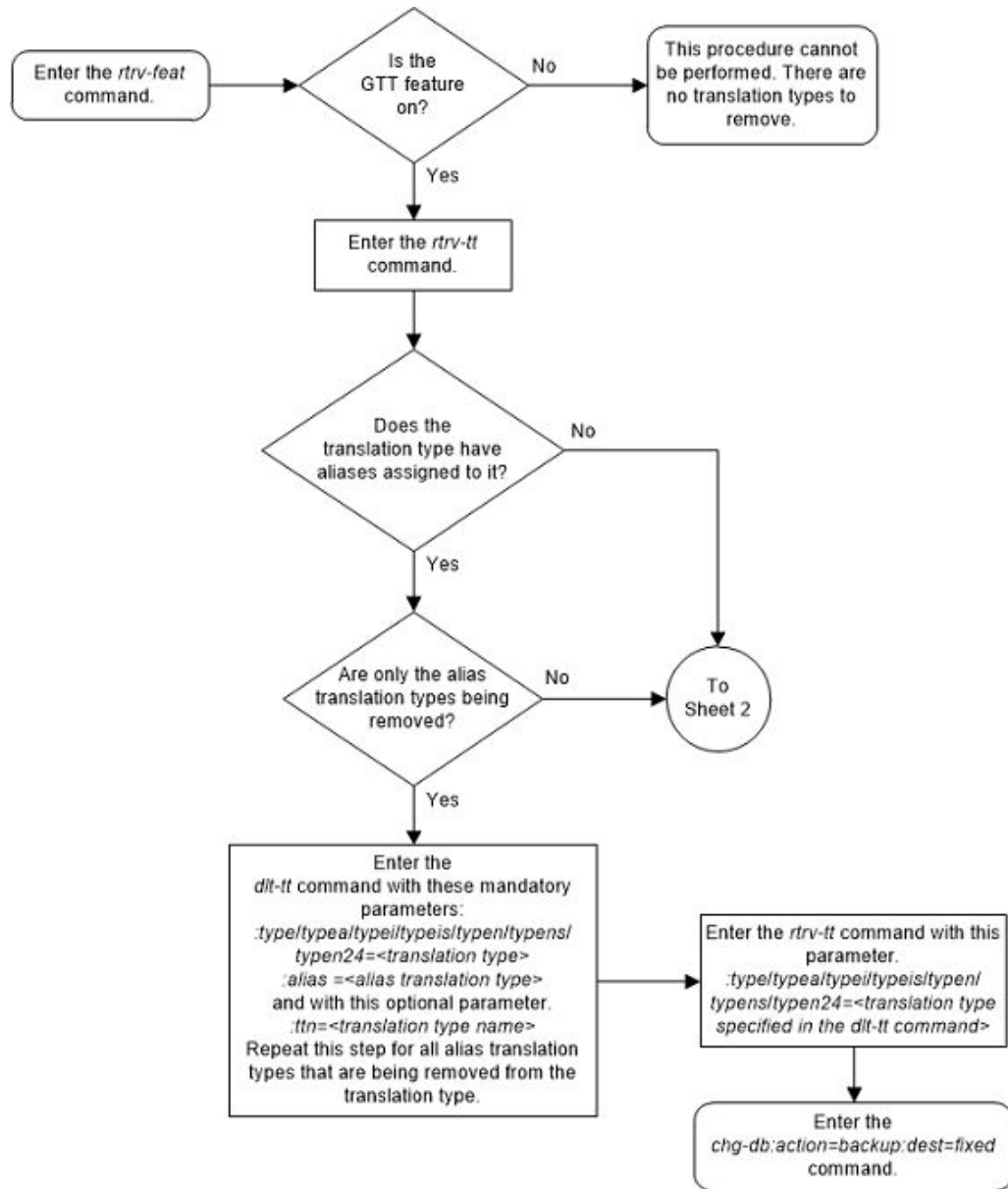

Figure 3-8 Remove a Translation Type - Sheet 2 of 4

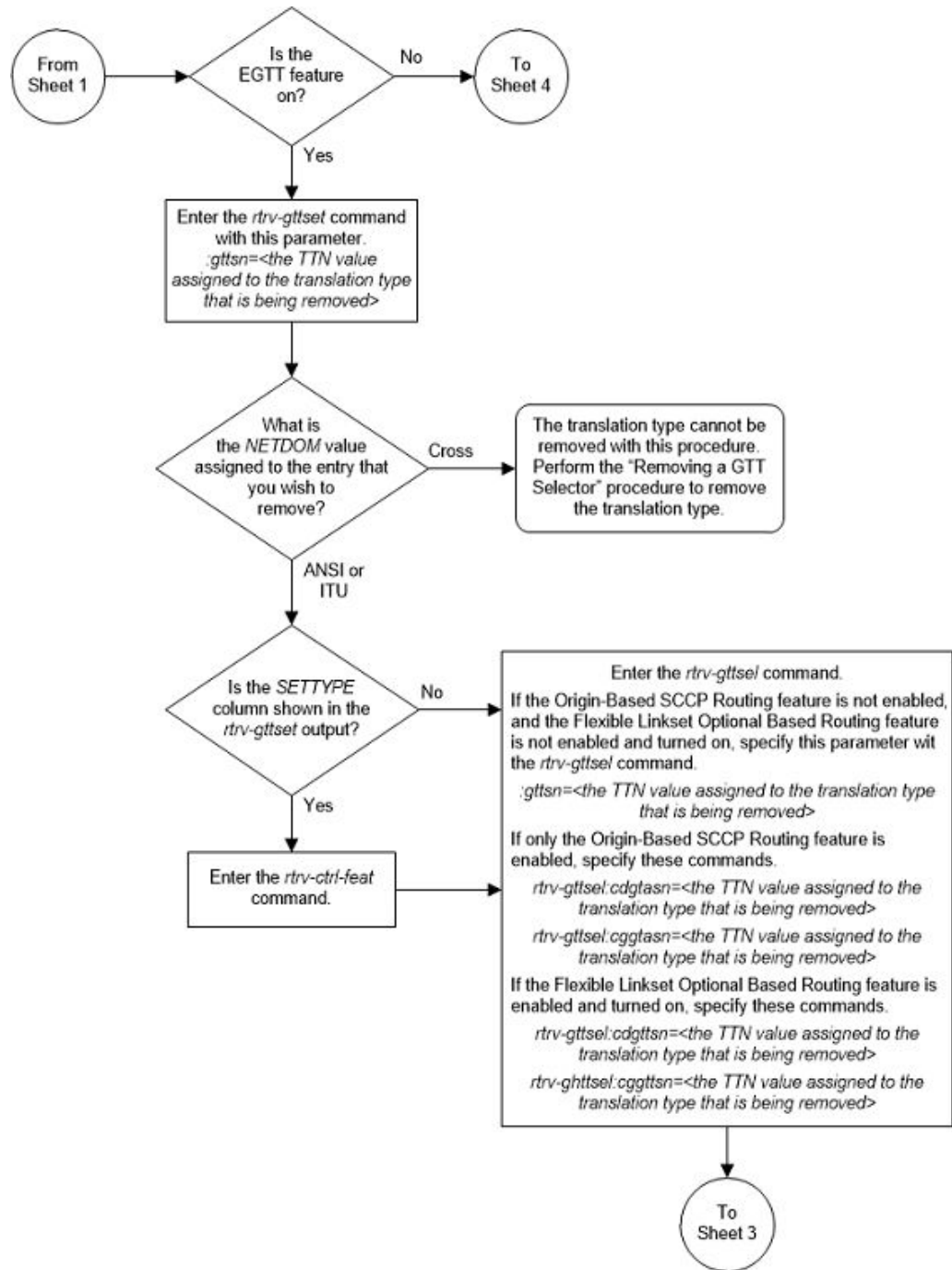

Figure 3-9 Remove a Translation Type - Sheet 3 of 4

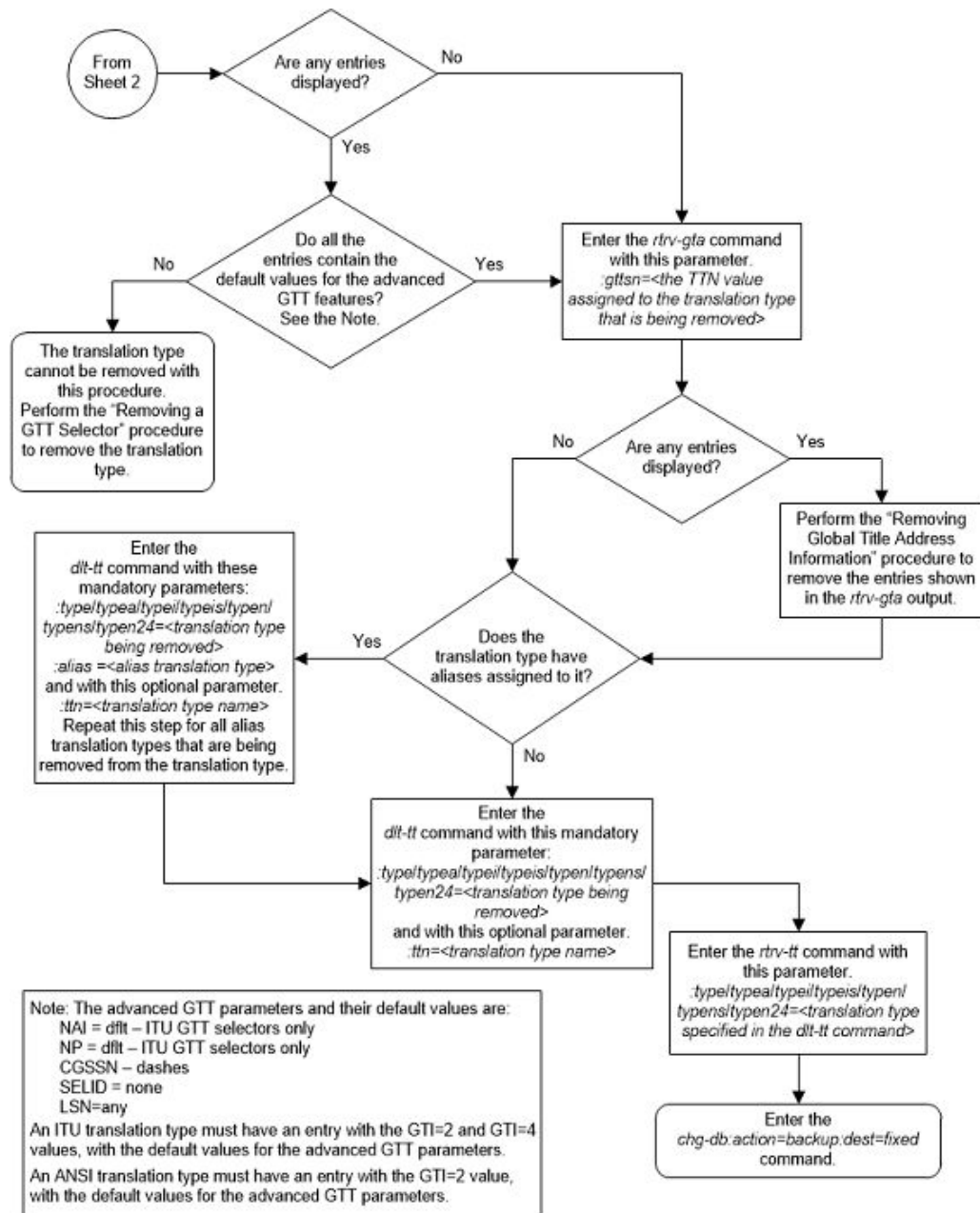
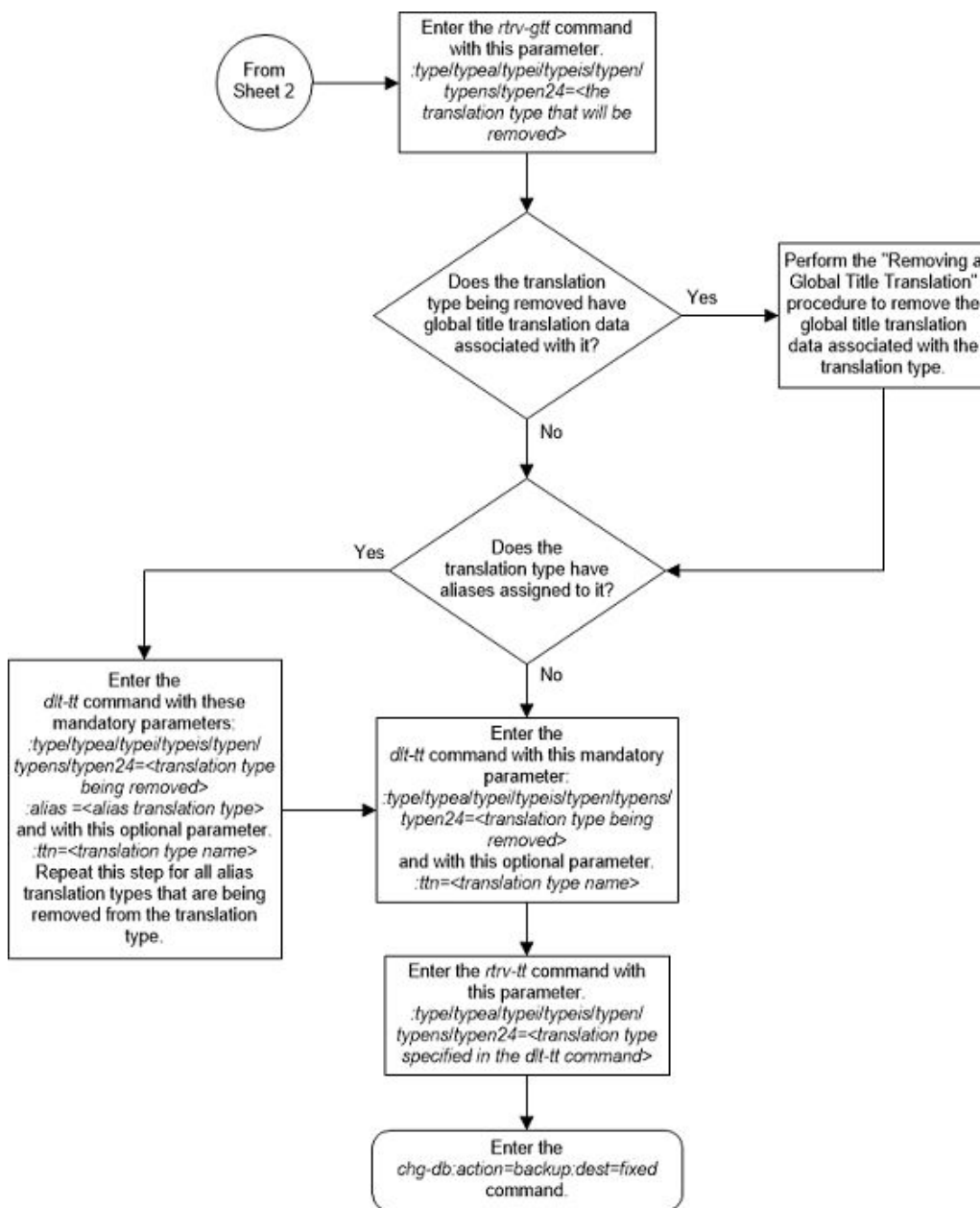

Figure 3-10 Remove a Translation Type - Sheet 4 of 4



Adding a Global Title Translation

This procedure is used to add a global title translation to the database using the `ent-gtt` command.

The `ent-gtt` command uses these parameters.

`:gta` – Global title start address – along with the `egta` parameter, identifies all valid global titles for the given translation type to translate to the given `pc` or `ssn` parameters. These are the non-SS7 addresses transmitted to the STP for translation.

`:type/typeea/typeei/typeeis/typen/typens/typen24` – The translation type and network type of the translation type that is being assigned to the global title translation. The value of this parameter is shown in the `rtrv-tt` output and provisioned in the [Adding a Translation Type](#) procedure.

`:ttn` - the translation type name associated with the `:type/typeea/typeei/typeeis/typen/typens/typen24` parameter value. The value of this parameter is shown in the `rtrv-tt` output and provisioned in the [Adding a Translation Type](#) procedure.

`:egta` – Global title end address – along with the `gta` parameter, identifies all valid global titles for the given translation type to translate to the given `pc` or `ssn` parameters. These are the non-SS7 addresses transmitted to the STP for translation.

`:force` – the mated application override. Is the global title translation to be entered without a mated application in the database?

`:xlat` – Translate indicator – defines the type of global title translation that is to be performed.

`:ri` – Route indicator – indicates whether a subsequent global title translation is required.

`:pc/pca/pci/pcn/pcn24` – The point code of the signaling point that is to receive the message.

 **Note:**

See Chapter 2, "Configuring Destination Tables," in *Database Administration - SS7 User's Guide* for a definition of the point code types that are used on the EAGLE and for a definition of the different formats that can be used for ITU national point codes.

`:ssn` – Subsystem number – identifies the subsystem address that is to receive the message.

`:gtmodid` - the name of the GT modification identifier shown in the `rtrv-gtmod` output and provisioned in the [Adding Global Title Modification Information](#) procedure. The GT modification identifier contains the information to modify the numbering plan, nature of address indicator, and the prefix or suffix digits in the called party address or calling party address portion of outbound MSUs.

`:mrnset` – The MRN set ID, shown in the `rtrv-mrn` command. This parameter can be specified only, and must be specified, if the Flexible GTT Load Sharing feature is enabled and if the `ri=gt` parameter is specified for the global title translation. If the Flexible GTT Load Sharing feature is enabled, the point code specified for the global title translation must be assigned to the MRN set specified by this parameter. The status of the Flexible GTT Load Sharing feature is shown in the `rtrv-ctrl-feat` output. To enable the Flexible GTT Load Sharing feature, perform the [Activating the Flexible GTT Load Sharing Feature](#) procedure.

`:mapset` – The MAP set ID, shown in the `rtrv-map` command. This parameter can be specified only, and must be specified, if the Flexible GTT Load Sharing feature is enabled and if the `ri=ssn` parameter is specified for the global title translation. If the Flexible GTT Load Sharing feature is enabled, the point code and SSN specified for the global title translation must be assigned to the MAP set specified by this

parameter. The status of the Flexible GTT Load Sharing feature is shown in the `rtrv-ctrl-feat` output. To enable the Flexible GTT Load Sharing feature, perform the [Activating the Flexible GTT Load Sharing Feature](#) procedure.

`:loopset` - The value of this parameter is the name of the loopset that is assigned to the GTT. This parameter can be specified only if the SCCP Loop Detection feature is enabled. Enter the `rtrv-loopset` command to verify that the SCCP Loop Detection feature is enabled. Perform the [Activating the SCCP Loop Detection Feature](#) procedure, if necessary. By default, the value of the `loopset` parameter is "none" because no loopset is assigned to the GTT.

`:cggtmod` - The calling party GT modification indicator. This parameter specifies whether or not calling party global title modification is required. The values for this parameter are `yes` (calling party global title modification is required) or `no` (calling party global title modification is not required). This parameter can be specified only if the AMGTT or AMGTT CgPA Upgrade feature is enabled. Enter the `rtrv-ctrl-feat` command to verify that either the AMGTT or AMGTT CgPA Upgrade feature is enabled. If the AMGTT or AMGTT CgPA Upgrade feature is not enabled, perform the [Activating the Advanced GT Modification Feature](#) procedure to enable the required feature.

 **Note:**

The command line on the terminal can contain up to 150 characters. If the parameters and values specified with the `ent-gtt` command are too long to fit on the `ent-gtt` command line, perform the [Changing a Global Title Translation](#) section to complete adding the GTT entry.

The `XLAT` parameter does not have a SEAS equivalent. When global title translations are configured at the SEAS interface, the values for the SEAS parameters `RI`, `DPC`, and `SSN`, all mandatory parameters for the SEAS `ADD-GTT` and `CHG-GTT` commands, are converted to the EAGLE parameters and values shown in the [Table 3-3](#) procedure.

Table 3-3 SEAS and Global Title Translation Parameter Conversion

SEAS GTT Parameters				GTT Parameters		
RI	DPC	SSN	XLAT	RI	PC/PCA	SSN
G	xxx-xxx-xxx	000	DPC	GT	xxx-xxx-xxx	Not Specified
D	xxx-xxx-xxx	002-255	DPCSSN	SSN	xxx-xxx-xxx	002-255
G	xxx-xxx-xxx	002-255	DPCSSN	GT	xxx-xxx-xxx	002-255
D	xxx-xxx-xxx	000	DPC	SSN	xxx-xxx-xxx	Not Specified

Table 3-3 (Cont.) SEAS and Global Title Translation Parameter Conversion

SEAS GTT Parameters	GTT Parameters
Notes:	
<ul style="list-style-type: none"> The SEAS RI=G parameter denotes global title routing, further global title translation is required. The SEAS RI=D parameter denotes DPC routing, no further global title translation is required. The RI=GT parameter denotes further global title translation is required and uses MTP routing. The RI=SSN parameter denotes final global title translation and uses MAP routing. The XLAT=DPC parameter indicates that the DPC & RI values in the MSU are to be replaced. The XLAT=DPCSSN parameter indicates that the DPC, RI, and SSN values in the MSU are to be replaced. The XLAT=DPCNGT parameter indicates that the DPC, RI, and TT values in the MSU are to be replaced. 	

The global title translation data cannot be added to the database if the translation type is defined as an alias and if the global title translation data is already assigned to that translation type.

If the translate indicator is equal to `dpc` (`xlat=dpc`) and the routing indicator is equal to `ssn` (`ri=ssn`), and the `force=yes` parameter is not specified, the point code specified in the `ent-gtt` command must be defined in the database as a mated application. Verify this by entering the `rtrv-map` command. If this point code is not defined as a mated application, perform one of these procedures to add the point code and subsystem number to the database as a mated application:

- [Provisioning a Solitary Mated Application](#)
- [Provisioning a Dominant Mated Application](#)
- [Provisioning a Load Shared Mated Application](#)
- [Provisioning a Combined Dominant/Load Shared Mated Application](#)

The point code and subsystem number do not have to be in the mated application table when the `ent-gtt` command is executed if these parameters are specified with the `ent-gtt` command.

- `ri=gt`
- `xlat=dpcssn` and `ri=ssn`

If the point code and subsystem, if applicable, are not in the mated application table when either of these parameters are specified with the `ent-gtt` command, the EAGLE creates a solitary mated application in the mated application table using the point code and subsystem values specified in the `ent-gtt` command.

If the `xlat=dpcssn` parameter is specified, the `ssn` parameter must be specified. Otherwise, the `ssn` parameter cannot be specified.

If a point code is the STP's True PC, then the value of the `XLAT` parameter must be set to `DPCSSN` and the value of the `RI` parameter must be set to `SSN`. If the `SSN` parameter is specified and a point code is the STP's True PC, then the subsystem number specified must exist in the `SS-APPL` table. This can be verified with the

`rtrv-ss-appl` command. To execute the `rtrv-ss-appl` command, one or more features shown in [Table 3-4](#) must be enabled, and turned on if necessary. The `rtrv-ctrl-feat` output shows the required status of the features.

Table 3-4 Feature Status

Feature	Feature's Status	Entry Displayed in the <code>rtrv-ctrl-feat</code> Output
LNP	Enabled	The entry LNP TNs with a quantity greater than zero (0)
EIR	Enabled and Turned On	EIR
INP	Enabled and Turned On	INP
ANSI-41 INP Query	Enabled and Turned On	ANSI-41 INP Query
V-Flex	Enabled and Turned On	VFLEX
ATINP	Enabled	ATINP
ANSI41 AIQ	Enabled	ANSI41 AIQ

The point code specified in the `ent-gtt` command must be defined in the routing table or be the EAGLE's point code. For ANSI point codes (`pc/pca`), the point code specified in the `ent-gtt` command, must be a full point code. That point code can be defined as a full point code in the destination point code table, or can be a member of a cluster point code defined in the destination point code table. Cluster point codes or a network routing point codes cannot be specified with this command. Enter the `rtrv-rte` command to verify that the point code is in the routing table. If the point code is not defined as a route, perform one of the Adding a Route procedures in *Database Administration – SS7 User's Guide* to define the point code as a route.

If the EAGLE's point code is specified with the `ent-gtt` command, then the `xlat=dpcssn` and `ri=ssn` parameters must be specified. The EAGLE's point code is shown in the `PCA`, `PCI`, `PCN`, or `PCN24` fields of the `rtrv-sid` command output.

If the `xlat=dpcngt` parameter is specified, the `ngt` parameter and the `ri=gt` parameters must be specified.

An ANSI point code or ITU international point code containing all zeros is not a valid point code and cannot be entered into the database. An ITU national point code containing all zeros is a valid point code and can be entered into the database.

Either the `type` parameter or the `ttn` parameter must be specified.

If the `type` parameter is specified, the translation type must be in the database. This can be verified with the `rtrv-tt` command.

If the `type` parameter is not specified, the translation type name must be assigned to a translation type in the database. This can be verified with the `rtrv-tt` command.

If the `type` and `ttn` parameters are specified, the specified translation type must be in the database and the specified translation type name must be assigned to the translation type.

If the translation type is ANSI (`type` or `typea`), the `pc` type must be ANSI (`pc` or `pca`). If the translation type is one of the ITU types (`typei`, `typen`, `typeis`, `typens`, or `typen24`) the `pc` type may be either of the ITU types (`pci`, `pcn`, or `pcn24`). If the ANSI/ITU SCCP Conversion feature is enabled, the domain (ANSI or ITU) of the translation type and point code do not have to be the same.

The end global title address (*egta*) must be greater than or equal to the start global title address (*gta*) and its length must be equal to the start global title address.

If the Variable-Length Global Title Translation (VGTT) feature is off, shown the entry `VGTT = off`, the global title address length must be equal to the number of digits specified by the given translation type. The length of the global title address can be verified with the `rtrv-tt` command.

If the Variable-Length Global Title Translation (VGTT) feature is on, shown the entry `VGTT = on`, up to 10 different length global title addresses can be assigned to a translation type. If the Activating the Support for 16 GTT Lengths in VGTT feature is enabled and on, shown the entry `VGTT` with `16 GTT lengths` in the `rtrv-ctrl-feat` output, up to 16 different length global title addresses can be assigned to a translation type. The length of the global title address is only limited by the range of values for the *gta* and *egta* parameters, one to 21 digits, and by the global title addresses already assigned to the translation type. The *ndgt* parameter of the `ent-tt` command has no effect on the length of the global title address. As global title addresses of different lengths are assigned to a specific translation type, these lengths are displayed in the *NDGT* field of the `rtrv-tt` command output.

If the translation type has maximum number of different length global title addresses assigned to it, and another global title address is specified for the translation type, the length of the global title address being added to the translation type must be the same as one of the lengths already assigned to the translation type. If the length of the global title address does not match one of the lengths already assigned to the translation type, the `ent-gtt` command is rejected with this message.

```
E4007 Cmd Rej: Exceeding max GTA Lengths supported per TT
```

If the translation type has less than the maximum number of different length global title addresses assigned to it, and another global title address is specified for the translation type, the length of the global title address can be from one to 21 digits and does not have to match the length of the other global title addresses assigned to the translation type.

Refer to [Variable-length Global Title Translation Feature](#) for more information about this feature.

The range, as specified by the start and end global title addresses, cannot already exist in the global title translation data for the specified translation type. If the ranges overlap, the range of global title addresses cannot be split and the `ent-gtt` command is rejected with this message.

```
E2401 Cmd Rej:GTA range overlaps a current range. GTA range overlaps a current range
```

Along with error message 2401, a list of the overlapped global title addresses is displayed as shown in the following example.

```
rlghncxa03w 07-02-24 08:29:15 GMT EAGLE5 35.6.0
The following GTA ranges overlap the input GTA range
```

START GTA	END GTA
8005550000	8005551999
8005552000	8005553999
8005554000	8005555999

ENT-GTT: MASP A - Command Aborted

Table 3-5 shows the valid combinations for the parameters. All other combinations are rejected.

Table 3-5 Valid Parameter Combinations for the ent-gtt Routing Parameters

XLAT Value	RI Value	Routing Action	SSN Value
DPC	GT	Translate DPC only and route on GT	Cannot specify
DPC	SSN	Translate DPC only and route on SSN	Cannot specify
DPCSSN	GT	Translate DPC and SSN and route on GT	Must specify
DPCSSN	SSN	Translate DPC and SSN and route on SSN	Must specify
DPCNGT	GT	Translate New GT and route on GT	Cannot specify

The EAGLE can contain 269,999, 400,000, or 1,000,000 global title translations. The system default is 269,999 global title translations. This quantity can be increased to 400,000 by enabling the feature access key for part number 893-0061-01, or to 1,000,000 by enabling the feature access key for part number 893-0061-10. For more information on enabling these feature access keys, perform the [Enabling the XGTT Table Expansion Feature](#) procedure.

Canceling the RTRV-GTT Command

Because the `rtrv-gtt` command used in this procedure can output information for a long period of time, the `rtrv-gtt` command can be canceled and the output to the terminal stopped. There are three ways that the `rtrv-gtt` command can be canceled.

- Press the F9 function key on the keyboard at the terminal where the `rtrv-gtt` command was entered.
- Enter the `canc-cmd` without the `trm` parameter at the terminal where the `rtrv-gtt` command was entered.
- Enter the `canc-cmd:trm=<xx>`, where `<xx>` is the terminal where the `rtrv-gtt` command was entered, from another terminal other than the terminal where the `rtrv-gtt` command was entered. To enter the `canc-cmd:trm=<xx>` command, the terminal must allow Security Administration commands to be entered from it and the user must be allowed to enter Security Administration commands. The terminal's permissions can be verified with the `rtrv-secu-trm` command. The user's permissions can be verified with the `rtrv-user` or `rtrv-secu-user` commands.

For more information about the `canc-cmd` command, go to *Commands User's Guide*.

1. Display the translation types in the database using the `rtrv-tt` command. This is an example of the possible output.

```
rlghncxa03w 10-07-25 09:42:31 GMT EAGLE5 42.0.0
TYPEA      TTN      NDGT
1          lidb     5
2          c800    10
3          d700    6
5          scp1    6
10         scp2    6
15         scp3    3

ALIAS      TYPEA
30         5
40         10
50         3
65         3

TYPEI      TTN      NDGT
105       itudb    8

ALIAS      TYPEI
7         105

TYPEN      TTN      NDGT
120       dbitu    7

ALIAS      TYPEN
8         120

TYPEIS     TTN      NDGT

ALIAS      TYPEIS

TYPENS     TTN      NDGT

ALIAS      TYPENS
```

If the required translation type is shown in the `rtrv-tt` output, continue the procedure with [2](#).

If the required translation type is not shown in the `rtrv-tt` output, perform the [Adding a Translation Type](#) procedure to add the translation type to the database. After the translation type has been added, continue the procedure with [10](#).

2. Verify that the EGTT feature is on, by entering the `rtrv-feat` command. If the GTT feature is on, the `EGTT` field should be set to `on`.

 **Note:**

The `rtrv-feat` command output contains other fields that are not used by this procedure. If you wish to see all the fields displayed by the `rtrv-feat` command, refer to the `rtrv-feat` command description in *Commands User's Guide*.

If the EGTT feature is off, continue the procedure with 5.

If the EGTT feature is on, continue the procedure with 3.

3. Display the features that are enabled by entering the `rtrv-ctrl-feat` command.

The following is an example of the possible output.

```
rlghncxa03w 10-07-28 21:15:37 GMT EAGLE5 42.0.0
The following features have been permanently enabled:
```

Feature Name	Partnum	Status	Quantity
Command Class Management	893005801	on	----
LNP Short Message Service	893006601	on	----
Intermed GTT Load Sharing	893006901	on	----
HC-MIM SLK Capacity	893012707	on	64

The following features have been temporarily enabled:

Feature Name	Partnum	Status	Quantity	Trial
Period Left				
Zero entries found.				

The following features have expired temporary keys:

Feature Name	Partnum
Zero entries found.	

4. Display the GTT selectors in the database by entering the `rtrv-gttsel` command with the TTN value associated with the translation type that will be assigned to the global title translation. The TTN value is shown in the `rtrv-tt` output in 1.

To specify of the TTN value, the parameters shown in [Table 3-6](#) must be specified with the `rtrv-gttsel` command. The parameters that can be specified are dependent on the features that are enabled, shown in 3.

Table 3-6 RTRV-GTTSEL Parameters

Feature that is Enabled	Parameter that must be Specified for the TTN Value
Neither the Origin Based SCCP Routing nor the Flexible Linkset Optional Based Routing, shown as Flex Lset Optnl Based Rtg in the <code>rtrv-ctrl-feat</code> output, is enabled.	<code>gttsn</code>

Table 3-6 (Cont.) RTRV-GTTSEL Parameters

Feature that is Enabled	Parameter that must be Specified for the TTN Value
Origin Based SCCP Routing	cdgtasn,cggtasn
Flexible Linkset Optional Based Routing	cdgttsn,cggttsn

For this example, enter these commands.

```
rtrv-gttsel:gttsn=scp1
```

```
rlghncxa03w 10-07-28 21:15:37 GMT EAGLE5 42.0.0
```

```
GTIA   TT   NP   NAI  SELID GTTSN
  2     5   --   ---  none  scp1
GTII   TT   NP   NAI  SELID GTTSN

GTIN   TT   NP   NAI  SELID GTTSN

GTIN24 TT   NP   NAI  SELID GTTSN

GTIIS  TT   NP   NAI  SELID GTTSN

GTINS  TT   NP   NAI  SELID GTTSN
```

```
rtrv-gttsel:gttsn=scp2
```

```
rlghncxa03w 10-07-28 21:15:37 GMT EAGLE5 42.0.0
```

```
GTIA   TT   NP   NAI  SELID GTTSN
  2    10  --   ---  none  scp2
GTII   TT   NP   NAI  SELID GTTSN

GTIN   TT   NP   NAI  SELID GTTSN

GTIN24 TT   NP   NAI  SELID GTTSN

GTIIS  TT   NP   NAI  SELID GTTSN

GTINS  TT   NP   NAI  SELID GTTSN
```

```
rtrv-gttsel:gttsn=scp3
```

```
rlghncxa03w 10-07-28 21:15:37 GMT EAGLE5 42.0.0
```

```
GTIA   TT   NP   NAI  SELID GTTSN
  2    15  --   ---  none  scp3
GTII   TT   NP   NAI  SELID GTTSN

GTIN   TT   NP   NAI  SELID GTTSN

GTIN24 TT   NP   NAI  SELID GTTSN
```

```
GTIIS  TT      NP      NAI  SELID GTTSN
GTINS  TT      NP      NAI  SELID GTTSN
```

If any of the entries shown in the `rtrv-gttset` output do not have the default values for the advanced GTT parameters, or if a GTT selector entry with the `TTN` value was removed with the `dlt-gttset` command, the remainder of this procedure cannot be performed. Choose another translation type to assign to the global title translation and repeat this procedure from [1](#).

If all of the entries shown in the `rtrv-gttset` output have the default values for the advanced GTT parameters, and none of the GTT selector entries with the `TTN` value were removed with the `dlt-gttset` command, continue the procedure with [5](#).

- Continue the procedure by performing one of these steps to verify if the VGTT or the Support for 16 GTT Lengths in VGTT features can be used to provision the global title translation.

If multiple values are shown in the `NDGT` column for any translation type entry, the Variable-Length Global Title Translation feature is turned on. If a translation type entry contains 11 - 16 values in the `NDGT` column, the Support for 16 GTT Lengths in VGTT feature is enabled and turned on.

- If no more than 10 values are shown in the `NDGT` column for any translation type, continue the procedure by performing one of these steps.
 - If the translation type will contain no more than 10 different length global title addresses, continue the procedure with [10](#).
 - If the translation type will contain more than 10 different length global title addresses, continue the procedure with [9](#).
- If more than 10 values are shown in the `NDGT` column for any translation type, continue the procedure with [10](#).

If only single values are shown in the `NDGT` column for all the translation type entries, continue the procedure by performing one of these steps.

- If the translation type will contain global title addresses of only one length, continue the procedure with [10](#).
 - If the translation type will contain multiple lengths of global title addresses, continue the procedure with [6](#).
- Verify that the VGTT feature is on, by entering the `rtrv-feat` command. If the VGTT feature is on, the VGTT field should be set to `on`. For this example, the VGTT feature is off.

Note:

The `rtrv-feat` command output contains other fields that are not used by this procedure. If you wish to see all the fields displayed by the `rtrv-feat` command, see the `rtrv-feat` command description in *Commands User's Guide*.

Continue the procedure by performing one of these steps.

- If the VGTT feature is on, continue the procedure by performing one of these steps.
 - If the translation type will contain no more than 10 different length global title addresses, continue the procedure with [10](#).
 - If the translation type will contain more than 10 different length global title addresses, continue the procedure with [9](#).
 - If the VGTT feature is off, continue the procedure with [7](#).
7. Display the cards in the EAGLE using the `rtrv-card` command. This is an example of the possible output.

```
rlghncxa03w 13-05-25 09:58:31 GMT EAGLE5 45.0.0
CARD   TYPE      APPL      LSET NAME      LINK SLC LSET NAME
LINK SLC
1102   TSM           GLS
1113   E5MCAP       EOAMHC
1114   E5TDM-A
1115   E5MCAP       EOAMHC
1116   E5TDM-B
1117   E5MDAL
1118   RESERVED
1201   LIMDS0       SS7ANSI   sp2             A    0    sp1
B      0
1203   LIMDS0       SS7ANSI   sp3             A    0
1204   LIMDS0       SS7ANSI   sp3             A    1
1206   LIMDS0       SS7ANSI   nsp3           A    1    nsp4
B      1
1308   LIMDS0       SS7ANSI   sp6             A    1    sp7
B      0
1314   LIMDS0       SS7ANSI   sp7             A    1    sp5
B      1
```

The correct service modules must be in the EAGLE before the VGTT feature can be turned on, or the Support for 16 GTT Lengths in VGTT feature can be enabled and turned on. See the [Adding a Service Module](#) procedure to determine the service modules that are required. If any service modules must be replaced, contact the Customer Care Center before replacing any service modules. Refer to [#unique_17](#) for the contact information.

8. Turn the Variable-length Global Title Translation (VGTT) feature on by entering this command.

```
chg-feat:vgtt=on
```

 **Note:**

Once the Variable-length Global Title Translation (VGTT) feature is enabled with the `chg-feat` command, it cannot be disabled. The VGTT feature must be purchased before turning it on. If you are not sure whether you have purchased the VGTT feature, contact your Sales Representative or Account Representative.

When the `chg-feat` has successfully completed, this message should appear.

```
rlghncxa03w 09-05-25 09:57:41 GMT EAGLE5 41.0.0
CHG-FEAT: MASP A - COMPLTD
```

Continue the procedure by performing one of these steps.

- If the translation type will contain no more than 10 different length global title addresses, continue the procedure with .
 - If the translation type will contain more than 10 different length global title addresses, perform the [Activating the Support for 16 GTT Lengths in VGTT Feature](#) procedure to enable and turn on the Support for 16 GTT Lengths in VGTT feature. After the Support for 16 GTT Lengths in VGTT feature has been enabled and turned on, continue the procedure with [10](#).
9. Display the status of the Support for 16 GTT Lengths in VGTT feature by entering this command.

```
rtrv-ctrl-feat:partnum=893024801
```

```
rlghncxa03w 09-05-25 09:57:41 GMT EAGLE5 41.0.0
The following features have been permanently enabled:
```

Feature Name	Partnum	Status	Quantity
VGTT with 16 GTT lengths	893024801	on	----

The following features have been temporarily enabled:

Feature Name	Partnum	Status	Quantity	Trial Period
Left				
Zero entries found.				

The following features have expired temporary keys:

Feature Name	Partnum
Zero entries found.	

If the Support for 16 GTT Lengths in VGTT feature is enabled and turned on, continue the procedure with [10](#).

If the Support for 16 GTT Lengths in VGTT feature is not enabled or turned on, perform the [Activating the Support for 16 GTT Lengths in VGTT Feature](#) procedure to enable and turn on the Support for 16 GTT Lengths in VGTT feature. After the Support for 16 GTT Lengths in VGTT feature has been enabled and turned on, continue the procedure with [10](#).

10. Display the global title translations in the database using the `rtrv-gtt` command specifying a translation type (`type`), translation type name (`ttn`), or both from the `rtrv-tt` command output shown in [1](#) along with the desired global title address (`gta`). If a range of global title addresses will be specified for the global title translation, the `egta` parameter can be specified with the `rtrv-gtt` command. For this example, enter these commands.

```
rtrv-gtt:typea=5:gta=910460
```

```
rtrv-gtt:typea=10:gta=615370:egta=615380
```

```
rtrv-gtt:typea=15:gta=800:egta=900
```

To add a global title translation, the desired global title addresses cannot be in the database. If the global title addresses are not in the database, the `rtrv-gtt` command is rejected with the following message.

```
E2405 Cmd Rej: GTA does not exist in any range
```

11. The global title translation cannot be added to the database if the database contains the maximum number of global title translations the EAGLE is allowed to have. The maximum number of global title translations is shown in the `rtrv-gtt` output in 10 or the `rtrv-ctrl-feat` output.

If error message E2405 was displayed in the output in 10, enter the `rtrv-ctrl-feat` command to verify the maximum number of global title translations that are allowed in the database.

If the 3 was performed, this step does not need to be performed.

The following is an example of the possible output.

```
rlghncxa03w 09-05-28 21:15:37 GMT EAGLE5 41.0.0
```

The following features have been permanently enabled:

Feature Name	Partnum	Status	Quantity
Command Class Management	893005801	on	----
LNP Short Message Service	893006601	on	----
Intermed GTT Load Sharing	893006901	on	----
HC-MIM SLK Capacity	893012707	on	64

The following features have been temporarily enabled:

Feature Name	Partnum	Status	Quantity	Trial
Period Left				
Zero entries found.				

The following features have expired temporary keys:

Feature Name	Partnum
Zero entries found.	

12. Continue the procedure by performing these steps based the XGTT Table Expansion entry that is shown in the `rtrv-ctrl-feat` output in either 3 or 11.

 **Note:**

If the entry XGTT Table Expansion is not shown in the `rtrv-ctrl-feat` output, the maximum number of global title addresses that the database can contain is 269,999.

If the maximum number of global title translations is 1,000,000, and adding the global title translation will exceed 1,000,000 global title translations, the new global

title translation cannot be added and the remainder of this procedure cannot be performed.

If the maximum number of global title translations is either 269,999 or 400,000 and adding the global title translation will exceed the maximum number of global title translations, perform the [Enabling the XGTT Table Expansion Feature](#) procedure to enable XGTT Table Expansion feature for either 400,000 or 1,000,000 global title translations as needed.

If adding the global title translation will not exceed the maximum number of global title translations, or if the [Enabling the XGTT Table Expansion Feature](#) procedure was performed in this step, continue the procedure by performing one of these steps.

- If the `gtmodid` parameter will be specified for the global title translation, continue the procedure with [13](#).
- If the `cggtmod=yes` parameter will be specified for the global title translation and the `gtmodid` parameter will not be specified for the global title translation, continue the procedure with [14](#).
- If the `gtmodid` and `cggtmod=yes` parameters will not be specified for the global title translation, continue the procedure with [15](#).

13. Display the GT modification information in the database using the `rtrv-gtmod` command.

This is an example of the possible output.

```
rlghncxa03w 10-07-07 00:29:31 GMT EAGLE5 42.0.0
```

GTMODID	NTT	NGTI	GT0FILL	NNP	NNAI	NPDD	NSDD	PRECD	CGPASSN
modid2	--	2	ON	--	--	--	--	PFX	--
modid5	--	2	OFF	--	--	--	--	PFX	--
modid6	--	4	ON	4	5	3	3	SFX	--
modid10	--	--	OFF	5	5	--	--	PFX	--
modid11	--	--	OFF	5	5	--	--	PFX	--

```
GTMOD table is (5 of 100000) 1% full.
```

If the desired GT modification entry is not displayed, perform the [Adding Global Title Modification Information](#) procedure to add the desired GT modification entry to the database.

If the desired GT modification entry is displayed or the [Adding Global Title Modification Information](#) procedure was performed, continue the procedure by performing one of these steps.

- If the `cggtmod=yes` parameter will be specified for the global title translation and the `gtmodid` parameter will not be specified for the global title translation, continue the procedure with [14](#).

- If the `cggtmod=yes` parameter will not be specified for the global title translation, continue the procedure with [15](#).
14. To specify the `cggtmod=yes` parameters in this procedure, one of these the Advanced GT Modification features must be enabled.
- AMGTT - 893021801
 - AMGTT CgPA Upgrade - 893021803

If the `rtrv-ctrl-feat` command was performed in [3](#) or [11](#), and the appropriate AMGTT entry is shown in the `rtrv-ctrl-feat` output, continue the procedure with [15](#).

If the `rtrv-ctrl-feat` command was not performed in [3](#) and [11](#), enter the `rtrv-ctrl-feat` command to verify the status of the Advanced GT Modification feature.

The following is an example of the possible output.

```
rlghncxa03w 10-07-28 21:15:37 GMT EAGLE5 42.0.0
The following features have been permanently enabled:
```

Feature Name	Partnum	Status	Quantity
IPGWx Signaling TPS	893012814	on	20000
ISUP Normalization	893000201	on	----
Command Class Management	893005801	on	----
LNP Short Message Service	893006601	on	----
Intermed GTT Load Sharing	893006901	on	----
HC-MIM SLK Capacity	893012707	on	64

The following features have been temporarily enabled:

Feature Name	Partnum	Status	Quantity	Trial Period Left
Zero entries found.				

The following features have expired temporary keys:

Feature Name	Partnum
Zero entries found.	

If the appropriate Advanced GT Modification feature is not shown in the `rtrv-ctrl-feat` output in this step, [3](#) or [11](#), perform the [Activating the Advanced GT Modification Feature](#) procedure to enable the appropriate Advanced GT Modification feature. After the Advanced GT Modification feature has been enabled, continue the procedure with [15](#).

15. A loopset can be assigned to the global title translation to determine if SCCP messages are being looped. The `loopset` parameter is used to assign a loopset to a global title translation. To assign a loopset to the global title translation, the SCCP Loop Detection feature must be enabled.

 **Note:**

If you do not wish to specify the `loopset` parameter with the `ent-gtt` command, continue the procedure with [17](#).

If the SCCP Loop Detection feature is enabled, the `LOOPSET` field is shown in the `rtrv-gtt` output, and the entry `SCCP Loop Detection` is shown in the `rtrv-ctrl-feat` output.

If the `LOOPSET` field is shown in the `rtrv-gtt` output in [10](#), continue the procedure with [16](#).

If error message `E2405` is displayed in the `rtrv-gtt` output in [10](#), enter the `rtrv-ctrl-feat` command with the SCCP Loop Detection feature part number to verify the status of the SCCP Loop Detection feature. Enter this command.

```
rtrv-ctrl-feat:partnum=893016501
```

The following is an example of the possible output.

```
rlghncxa03w 09-05-28 21:15:37 GMT EAGLE5 41.0.0
```

The following features have been permanently enabled:

Feature Name	Partnum	Status	Quantity
SCCP Loop Detection	8930165101	on	----

The following features have been temporarily enabled:

Feature Name	Partnum	Status	Quantity	Trial Period Left
Zero entries found.				

The following features have expired temporary keys:

Feature Name	Partnum
Zero entries found.	

If the SCCP Loop Detection feature is enabled, continue the procedure with [16](#).

If the `LOOPSET` field does not appear in the `rtrv-gtt` output in [10](#), or the `rtrv-ctrl-feat` output shows that the SCCP Loop Detection feature is not enabled, perform the [Activating the SCCP Loop Detection Feature](#) procedure to enable the SCCP Loop Detection feature. After the SCCP Loop Detection feature has been enabled, perform the [Adding a Loopset](#) procedure to add the required loopset. After the loopset has been added, continue the procedure with [17](#).

16. Display all the loopsets in the database by entering this command

```
rtrv-loopset:num=1000:force=yes
```

This is an example of the possible output.

LoopSet	Mode	Point Codes
=====		
cary2	notify	005-015-005 007-007-007 (ANSI) 033-004-003 033-007-003

		005-027-005	007-004-007
cary4	notify	005-012-005	007-026-007 (ANSI)
		003-049-003	033-002-003
		005-008-055	007-014-007
apex3	discard	005-017-008	007-017-009 (ANSI)
		033-005-043	005-014-005
		005-017-005	007-014-007
		033-002-043	005-038-005
		007-009-027	033-003-043
		005-012-005	007-002-027
apex4	discard	005-007-008	027-007-009 (ANSI)
		033-005-003	005-004-055
		027-001-007	033-008-003
		033-007-003	005-003-055
		027-008-007	
ral5	notify	005-005-005	007-007-007 (ANSI)
		003-004-003	003-001-003
		005-007-005	007-004-007
		003-002-003	005-008-005
		007-009-007	003-003-003
		005-002-005	007-002-007
ral6	notify	005-007-008	007-007-009 (ANSI)
		003-005-003	003-007-003
		005-007-005	
dunn1	discard	005-002-055	007-051-007 (ANSI)
		003-008-033	
rtp9	discard	005-002-005	007-001-007 (ANSI)
		003-008-003	003-007-003
		005-003-005	007-008-007
		005-004-005	
rtp5	discard	005-007-008	007-007-009 (ANSI)
		003-005-003	
rtp1	discard	005-005-005	007-007-007 (ANSI)
		003-004-003	003-007-003
		005-007-005	007-004-007
		005-004-005	
rtp2	notify	005-007-008	007-007-009 (ANSI)
		003-005-003	

```
rlghncxa03w 09-05-28 21:15:37 GMT EAGLE5 41.0.0
LOOPSET table is (11 of 1000) 1% full
RTRV-LOOPSET: MASP A - COMPLTD
```

 **Note:**

If the `trv-loopset` command is entered with no other parameters specified, a maximum of 50 entries are displayed. To display more than 50 entries, the `force=yes` parameter must be specified with the `trv-loopset` command and the `num` parameter value must be greater than 50. Since there can be a maximum of 1000 loopsets in the database, to display all the loopsets in the database, the `force=yes` and `num = 1000` parameters must be specified with the `trv-loopset` command.

If the required loopset is shown in the `rtrv-loopset` output, continue the procedure with [17](#).

If the required loopset is not shown in the `rtrv-loopset` output, perform the [Adding a Loopset](#) procedure to add the required loopset. After the loopset has been added, continue the procedure with [17](#).

17. Hexadecimal digits (0-9, a-f, A-F) can be specified as values for the `gta` or `egta` parameters only if the Hex Digit Support for GTT feature is enabled. Verify the status of the Hex Digit Support for GTT feature by entering the `rtrv-ctrl-feat` command with the Hex Digit Support for GTT feature part number.



Note:

If hexadecimal digits are shown in the `rtrv-gtt` output in [10](#), or if hexadecimal digits will not be specified for the `gta` or `egta` parameters in this procedure, continue the procedure with [18](#).

Enter this command.

```
rtrv-ctrl-feat:partnum=893018501
```

The following is an example of the possible output.

```
rlghncxa03w 09-05-28 21:15:37 GMT EAGLE5 41.0.0
```

The following features have been permanently enabled:

Feature Name	Partnum	Status	Quantity
Hex Digit Support for GTT	893018501	on	----

The following features have been temporarily enabled:

Feature Name	Partnum	Status	Quantity	Trial
Period Left				
Zero entries found.				

The following features have expired temporary keys:

Feature Name	Partnum
Zero entries found.	

If the Hex Digit Support for GTT feature has not been enabled, perform the [Activating the Hex Digit Support for GTT Feature](#) procedure to enable this feature. After the Hex Digit Support for GTT feature is enabled, continue the procedure with [18](#).

18. Verify that the ANSI/ITU SCCP Conversion feature is enabled by entering the `rtrv-ctrl-feat:partnum=893012001` command. The following is an example of the possible output.

```
rlghncxa03w 09-05-28 21:15:37 GMT EAGLE5 41.0.0
```

The following features have been permanently enabled:

Feature Name	Partnum	Status	Quantity
--------------	---------	--------	----------

```
SCCP Conversion      893012001      on      ----
```

The following features have been temporarily enabled:

```
Feature Name      Partnum      Status      Quantity      Trial Period
Left
Zero entries found.
```

The following features have expired temporary keys:

```
Feature Name      Partnum
Zero entries found.
```

If the ANSI/ITU SCCP Conversion feature is not enabled, perform the [Activating the ANSI/ITU SCCP Conversion Feature](#) procedure to enable the ANSI/ITU SCCP Conversion feature.

 **Note:**

If the domain (ANSI or ITU) of the point code and the translation type assigned to the global title translation will be different, and the `thengti` parameter will be specified with the global title translation, the ANSI/ITU SCCP Conversion feature (SCCP Conversion) must be enabled. If the ANSI/ITU SCCP Conversion feature is not being used, or if the `trrv-ctrl-feat` output in this step shows that the ANSI/ITU SCCP Conversion feature is enabled, continue the procedure with [19](#).

19. To use either the `mrnset` parameter (if the routing indicator value for the global title translation is GT) or `mapset` parameter (if the routing indicator value for the global title translation is SSN), the Flexible GTT Load Sharing feature must be enabled.

If the Flexible GTT Load Sharing feature is enabled, either the `mrnset` or `mapset` parameters, depending on the routing indicator value for the global title translation being added in this procedure, must be specified with the `ent-gtt` command.

Verify that the Flexible GTT Load Sharing feature is enabled by entering this command.

```
trrv-ctrl-feat:partnum=893015401
```

The following is an example of the possible output.

```
rlghncxa03w 09-05-28 21:15:37 GMT EAGLE5 41.0.0
```

The following features have been permanently enabled:

```
Feature Name      Partnum      Status      Quantity
Flexible GTT Load Sharing 893015401      on      ----
```

The following features have been temporarily enabled:

```
Feature Name      Partnum      Status      Quantity      Trial Period      Left
Zero entries found.
```

The following features have expired temporary keys:

```
Feature Name      Partnum
Zero entries found.
```

If the routing indicator for the global title translation being added is GT, there are three actions that can be taken.

- If the Flexible GTT Load Sharing feature is not enabled, and you do not wish to specify the `mrnset` parameter for the global title translation, continue the procedure with [20](#).
- If the Flexible GTT Load Sharing feature is not enabled, and you do wish to specify the `mrnset` parameter for the global title translation, perform the [Activating the Flexible GTT Load Sharing Feature](#) procedure to enable the Flexible GTT Load Sharing feature. After enabling the Flexible GTT Load Sharing feature, continue the procedure with [23](#).
- If the Flexible GTT Load Sharing feature is enabled, continue the procedure with [23](#).

If the routing indicator for the global title translation being added is SSN, there are three actions that can be taken:

- If the Flexible GTT Load Sharing feature is not enabled, and you do not wish to specify the `mapset` parameter for the global title translation, continue the procedure with one of these steps.
 - If the point code value is the EAGLE's point code, continue the procedure with [2424](#).
 - If the point code value is a value other than the EAGLE's point code, the `ri` parameter value will be `ssn`, and the `xlat` parameter value will be `dpc`, continue the procedure with [26](#).
 - If the point code value is a value other than the EAGLE's point code, the `ri` parameter value will be `ssn`, and the `xlat` parameter value will be `dpcssn` when this procedure is completed, continue the procedure with [26](#).
- If the Flexible GTT Load Sharing feature is not enabled, and you do wish to specify the `mapset` parameter for the global title translation, perform the [Activating the Flexible GTT Load Sharing Feature](#) procedure to enable the Flexible GTT Load Sharing feature. After enabling the Flexible GTT Load Sharing feature, continue the procedure with one of these steps.
 - If the point code value is the EAGLE's point code, continue the procedure with [24](#).
 - If the point code value is a value other than the EAGLE's point code, or the `xlat` parameter value will be `dpc`, continue the procedure with [26](#).
- If the Flexible GTT Load Sharing feature is enabled, perform one of these steps.
 - If the point code value is the EAGLE's point code continue the procedure with [24](#).
 - If the point code value is a value other than the EAGLE's point code, or the `xlat` parameter value will be `dpc`, continue the procedure with [26](#).

20. Display the destination point codes in the database by entering the `rtrv-dstn` command. This is an example of the possible output.

```
rlghncxa03w 10-12-10 11:43:04 GMT EAGLE5 43.0.0
Extended Processing Time may be Required
```

DPCA	CLLI	BEI	ELEI	ALIASI
ALIASN/N24	DMN			
001-207-000	-----	no	---	-----
-----	SS7			
001-001-001	-----	no	---	-----
-----	SS7			
001-001-002	-----	no	---	-----
-----	SS7			
001-005-000	-----	no	---	-----
-----	SS7			
001-007-000	-----	no	---	-----
-----	SS7			
008-012-003	-----	no	---	-----
-----	SS7			
003-002-004	-----	no	---	-----
-----	SS7			
009-002-003	-----	no	---	-----
-----	SS7			
010-020-005	-----	no	---	-----
-----	SS7			

DPCI	CLLI	BEI	ELEI	ALIASA
ALIASN/N24	DMN			
1-207-0	-----	no	---	-----
-----	SS7			
0-015-0	-----	no	---	-----
-----	SS7			
0-017-0	-----	no	---	-----
-----	SS7			
1-011-1	-----	no	---	-----
-----	SS7			
1-011-2	-----	no	---	-----
-----	SS7			

```
Destination table is (14 of 2000) 1% full
Alias table is (0 of 12000) 0% full
PPC table is (1 of 20) 5% full
```

If the required point code is not shown in the `rtrv-dstn` output, perform the "Adding a Destination Point Code" procedure in *Database Administration - SS7 User's Guide* to add the required point code. A proxy point code cannot be assigned to the point code.

After the new point code has been added, perform one of the Adding a Route procedures in *Database Administration - SS7 User's Guide* to add the required route to the database. After the route has been added, continue the procedure with [27](#).

21. Display the point code that will be assigned to the global title translation by using the `rtrv-dstn` command and specifying the point code. For this example, enter this command.

```
rtrv-dstn:dpca=010-020-005
```

This is an example of the possible output.

```
rlghncxa03w 10-12-10 11:43:04 GMT EAGLE5 43.0.0
```

DPCA	CLLI	BEI	ELEI	ALIASI
ALIASN/N24	DMN			
010-020-005	-----	no	---	-----
-----	SS7			

PPCA	NCAI	PRX	RCAUSE	NPRST	SPLITIAM	HMSMSC	HMSCP
SCCPMSGCNV							
009-002-003	----	no	50	on	20	no	no none

Destination table is (14 of 2000) 1% full

Alias table is (0 of 12000) 0% full

PPC table is (1 of 20) 5% full

If the point code is not shown in the `rtrv-dstn` command output, the following output is displayed.

```
rlghncxa03w 09-05-10 11:43:04 GMT EAGLE5 41.0.0
```

No destinations meeting the requested criteria were found

Destination table is (14 of 2000) 1% full

Alias table is (0 of 12000) 0% full

PPC table is (1 of 20) 5% full

A proxy point code (a point code value is shown in the PPC column) cannot be assigned to the point code. If a proxy point code is shown in this step, choose another point code from the `rtrv-dstn` output in 20 and repeat this step.

If the point code is not shown in the `rtrv-dstn` output, perform the “Adding a Destination Point Code” procedure in *Database Administration - SS7 User's Guide* and add the point code to the destination point code table.

22. The point code specified with the `ent-gtt` command must be the DPC of a route, unless the point code is the EAGLE's point code. Enter the `rtrv-rte` command with the `dpca` parameter specifying the point code to be used with the `ent-gtt` command to verify whether or not the point code is the DPC of a route.

For this example, enter these commands.

```
rtrv-rte:dpca=007-007-007
```

This is an example of the possible output.

```
rlghncxa03w 09-05-07 11:43:04 GMT EAGLE5 41.0.0
```

DPCA	ALIASI	ALIASN/N24	LSN	RC	APCA
007-007-007	-----	-----	1s03	10	007-007-007
			1s02	30	150-150-150

```
lsa2      50      200-200-200
RTX:No    CLLI=ls03c1li
```

```
rtrv-rte:dpca=003-003-003
```

This is an example of the possible output.

```
rlghncxa03w 09-05-07 11:43:04 GMT EAGLE5 41.0.0
  DPCA      ALIASI      ALIASN/N24    LSN      RC      APCA
003-003-003  -----      -----      ls02     10     002-002-002
                                     ls08     30     025-025-150
                                     lsa5     50     066-030-100
RTX:No      CLLI=ls07c1li
```

```
rtrv-rte:dpca=005-005-005
```

This is an example of the possible output.

```
rlghncxa03w 09-05-07 11:43:04 GMT EAGLE5 41.0.0
  DPCA      ALIASI      ALIASN/N24    LSN      RC      APCA
005-005-005  -----      -----      ls05     10     005-005-005
                                     ls15     30     089-047-123
                                     lsa8     50     077-056-000
RTX:No      CLLI=ls05c1li
```

If the point code is not shown in the `rtrv-rte` output, perform one of the Adding a Route procedures in *Database Administration - SS7 User's Guide* and add the required route to the database.

23. The point code and MRN set ID specified for the global title translation must be shown in the `rtrv-mrn` command output. The point code must be assigned to the MRN set that will be assigned to the global title translation.

Enter the `rtrv-mrn` command to verify that the required MRN set is configured in the database, and that the required point code is assigned to the MRN set. The following is an example of the possible output.

```
rlghncxa03w 09-05-28 21:15:37 GMT EAGLE5 41.0.0
```

```
MRNSET  PC      RC
DFLT    001-001-001  10
         001-001-002  20
         001-001-003  30
```

```
MRNSET  PC      RC
110     001-001-001  10
         001-001-005  20
         001-001-006  30
         001-001-003  40
         001-001-008  50
```

```
MRNSET  PC      RC
111     001-001-001  30
         001-001-005  30
         001-001-006  30
```

```

001-001-003    30
001-001-008    30

MRNSET  PC          RC
112     001-003-001  10
        001-003-002  10
        001-003-003  30
        001-003-004  30
        001-003-006  60
        001-003-007  60
        001-003-008  80
        001-003-009  80

MRNSET  PCN          RC
113     s-1-1-1-0123-aa  1
        s-1-1-1-0235-aa  2
        s-1-1-1-0235-aa  3

```

 **Note:**

If the Weighted GTT Load Sharing feature is enabled, the WT, %WT, and THR columns are shown in the `rtrv-mrn` output

If the required MRN set is not shown in the `rtrv-mrn` output, or if the required point code is not assigned to the required MRN set, provision the required MRN set by performing the [Provisioning MRN Entries](#) procedure. After provisioning the required MRN set, continue the procedure with [27](#).

If the required MRN set is shown in the `rtrv-mrn` output, or if the required point code is assigned to the required MRN set, continue the procedure with [27](#).

 **Note:**

If the EAGLE's point code is not going to be used for the `pc` parameter of the `ent-gtt` command, continue the procedure with [26](#).

24. If the `ri=ssn` and `xlat=dpcssn` parameters are specified with the `ent-gtt` command, and you wish to use the EAGLE's point code for the value of the `pc` parameter of the `ent-gtt` command, the point code value must be in the EAGLE's self ID table. Display the EAGLE self-identification, using the `rtrv-sid` command.

This is an example of the possible output.

```

rlghncxa03w 09-05-10 11:43:04 GMT EAGLE5 41.0.0

PCA          PCI          PCN          CLLI          PCTYPE
010-020-030  1-023-1          12-0-14-1    rlghncxa03w   OTHER
              s-1-023-1        s-12-0-14-1

CPCA
002-002-002  002-002-003      002-002-004  002-002-005

```

002-002-006	002-002-007	002-002-008	002-002-009
004-002-001	004-003-003	050-060-070	
CPCI			
1-001-1	1-001-2	1-001-3	1-001-4
1-002-1	1-002-2	1-002-3	1-002-4
2-001-1	7-222-7		
CPCN			
2-0-10-3	2-0-11-0	2-0-11-2	2-0-12-1
2-2-3-3	2-2-4-0	10-14-10-1	

25. Enter the `rtrv-ss-appl` command to verify that either the LNP, EIR, V-Flex, ATINPQ, INP, or AIQ subsystem number (depending on which feature is on) is in the subsystem application table.

This is an example of the possible output.

```
rlghncxa03w 09-05-28 14:42:38 GMT EAGLE5 41.0.0
APPL      SSN      STAT
LNP      254      ONLINE
```

SS-APPL table is 20% FULL (1 of 5)

If the subsystem number is shown in the `rtrv-ss-appl` output, go to 26. If no subsystem number is shown in the `rtrv-ss-appl` output, or if the `rtrv-ss-appl` command is rejected, go to one of these User's Guides, depending on the type of subsystem you wish to use, to enable and turn on the feature as necessary, and add the subsystem to the subsystem application table:

- EIR subsystem – go to *EIR User's Guide*.
- INP subsystem – go to *INP/AINPQ User's Guide*.
- LNP subsystem – go to *ELAP Administration and LNP Feature Activation Guide*.
- V-Flex subsystem – go to *V-Flex User's Guide*.
- ATINPQ subsystem – go to *ATINP User's Guide*.
- AIQ subsystem – go to *Analyzed Information Features User's Guide*.

 **Note:**

If the Flexible GTT Load Sharing feature is enabled, shown in 19, a MAP set ID must be specified for the final global title translation. The point code and SSN specified for the final global title translation being added in this procedure must be assigned to the MAP set ID that will be assigned to the final global title translation. Perform 26 to verify that the required MAP set is configured in the database.

 **Note:**

If the Flexible GTT Load Sharing feature is not enabled, and the `ri=ssn` and `xlat=dpc` parameters are not being specified with the `ent-gtt` command, or if the EAGLE's true point code and the EAGLE's subsystem number, along with the `ri=ssn` and `xlat=dpc` parameters, are not being specified with the `ent-gtt` command, continue the procedure with 27.

26. Enter the `rtrv-map` command with the `pc` parameter specifying the required point code to verify that the required data is in the mated application table.

For this example enter this command.

```
rtrv-map:pca=005-005-005
```

If the Flexible GTT Load Sharing feature is not enabled, this is an example of the possible output.

```
rlghncxa03w 09-07-25 09:42:31 GMT EAGLE5 41.1.0

PCA          Mate PCA          SSN RC MULT SRM MRC GRP NAME SSO
005-005-005          250 10 SOL *Y *Y GRP01     ON
```

MAP table is (37 of 1024) 4% full.

If the Flexible GTT Load Sharing feature is enabled, this is an example of the possible output.

```
rlghncxa03w 09-07-25 09:42:31 GMT EAGLE5 41.1.0

MAPSET ID=DFLT
PCA          Mate PCA          SSN RC MULT SRM MRC GRP NAME SSO
005-005-005          55  5  DOM YES YES ----- OFF
                   001-001-002  15 15  DOM YES YES ----- ON
                   001-001-003  25 20  DOM YES YES ----- ON
                   001-001-002  40 35  DOM YES YES ----- OFF

MAPSET ID=1
PCA          Mate PCA          SSN RC MULT SRM MRC GRP NAME SSO
005-005-005          50  5  DOM YES YES ----- OFF
                   001-001-002  10 15  DOM YES YES ----- ON
                   001-001-003  20 20  DOM YES YES ----- ON
                   001-001-002  40 35  DOM YES YES ----- OFF

MAPSET ID= 2
PCA          Mate PCA          SSN RC MULT SRM MRC GRP NAME SSO
005-005-005          5  10 SOL *Y *Y ----- OFF
```

MAP table is (12 of 36000) 1% full.

If the `ri=ssn` and `xlat=dpc` parameters are being specified with the `ent-gtt` command, the point code must be in the mated application table. If the point code

is not in the mated application table when the `ent-gtt` command is executed, the `force=yes` parameter must be specified with the `ent-gtt` command.

If the EAGLE's true point code and the EAGLE's subsystem number, along with the `ri=ssn` and `xlat=dpcssn` parameters are being specified with the `ent-gtt` command, the EAGLE's true point code and the EAGLE's subsystem number must be in the mated application table.

If the required point code, subsystem number, or MAP set ID is not shown in the `rtrv-map` output, perform one of these procedures to add the required information to the mated application table.

- [Provisioning a Solitary Mated Application](#)
- [Provisioning a Dominant Mated Application](#)
- [Provisioning a Load Shared Mated Application](#)
- [Provisioning a Combined Dominant/Load Shared Mated Application](#)

27. Add the global title translation to the database using the `ent-gtt` command using the parameter combinations shown in [Table 3-7](#).

For this example, enter these commands.

```
ent-
gtt:typea=5:gta=910460:egta=919460:xlat=dpcngt:ri=gt :pca=007
-007-007:ttn=scp1:mrnset=114:cggmod=yes:gtmodid=modid2

ent-
gtt:typea=10:gta=615370:egta=615380:xlat=dpcssn:ri=ssn :pca=0
03-003-003:ssn=254:ttn=scp2:mapset=3

ent-
gtt:typea=15:gta=800:egta=900:xlat=dpc:ri=ssn:pca=005-005-005
:ttn=scp3:mapset=1:loopset=rtp:cggmod=yes
```

When each of these commands have successfully completed, this message should appear.

```
rlghncxa03w 09-05-07 11:44:13 GMT EAGLE5 41.0.0
ENT-GTT: MASP A - COMPLTD
```

 **Note:**

The command line on the terminal can contain up to 150 characters. If the parameters and values specified with the `ent-gtt` command are too long to fit on the `ent-gtt` command line, perform the [Changing a Global Title Translation](#) procedure to complete adding the GTT entry.

Table 3-7 Add GTT Parameter Combinations

RI = GT XLAT= DPCNGT	RI = GT XLAT= DPCSSN	RI = GT XLAT= DPC	RI = SSN XLAT= DPCSSN	RI = SSN XLAT= DPC
Mandatory Parameters				

Table 3-7 (Cont.) Add GTT Parameter Combinations

RI = GT XLAT= DPCNGT	RI = GT XLAT= DPCSSN	RI = GT XLAT= DPC	RI = SSN XLAT= DPCSSN	RI = SSN XLAT= DPC
TYPE/TYPEA/ TYPEI/TYPEN/ TYPEIS/ TYPENS/ TYPEN24 (See Notes 2 and 3)	TYPE/TYPEA/ TYPEI/TYPEN/ TYPEIS/ TYPENS/ TYPEN24 (See Notes 2 and 3)	TYPE/TYPEA/ TYPEI/TYPEN/ TYPEIS/ TYPENS/ TYPEN24 (See Notes 2 and 3)	TYPE/TYPEA/ TYPEI/TYPEN/ TYPEIS/ TYPENS/ TYPEN24 (See Notes 2 and 3)	TYPE/TYPEA/ TYPEI/TYPEN/ TYPEIS/ TYPENS/ TYPEN24 (See Notes 2 and 3)
PC/PCA/PCI/ PCN/PCN24 (See Notes 1, 3, and 8)	PC/PCA/PCI/ PCN/PCN24 (See Notes 1, 3, and 8)	PC/PCA/PCI/ PCN/PCN24 (See Notes 1, 3, and 8)	PC/PCA/PCI/ PCN/PCN24 (See Notes 1, 3, and 8)	PC/PCA/PCI/ PCN/PCN24 (See Notes 1, 3, and 8)
GTA (See Notes 4, 5, 6, 12, 14, and 16)	GTA (See Notes 4, 5, 6, 12, 14, and 16) SSN	GTA (See Notes 4, 5, 6, 12, 14, and 16)	GTA (See Notes 4, 5, 6, 12, 14, and 16) SSN	GTA (See Notes 4, 5, 6, 12, 14, and 16)
Optional Parameters				
TTN (See Notes 14, 15, and 16)	TTN (See Notes 14, 15, and 16)	TTN (See Notes 14, 15, and 16)	TTN (See Notes 14, 15, and 16)	TTN (See Notes 14, 15, and 16)
EGTA(See Note 17)	EGTA (See Note 17)	EGTA (See Note 17)	EGTA (See Note 17)	EGTA (See Note 17)
GTMODID (See Note 18)	GTMODID (See Note 18)	GTMODID (See Note 18)	GTMODID (See Note 18)	GTMODID (See Note 18)
MRNSET (See Note 9)	MRNSET (See Note 9)	MRNSET (See Note 9)	MAPSET (See Note 11)	MAPSET (See Note 11)
LOOPSET (See Note 13)	LOOPSET (See Note 13)	LOOPSET (See Note 13)	LOOPSET (See Note 13)	LOOPSET (See Note 13)
CGGTMOD (See Note 7)	CGGTMOD (See Note 7)	CGGTMOD (See Note 7)	CGGTMOD (See Note 7)	CGGTMOD (See Note 7) FORCE (See Note 10)

NTT (See Note
19)

Parameter Values:

TYPE/TYPEA/TYPEI/TYPEN/TYPEIS/TYPENS/TYPEN24 – The translation type from the TYPE/TYPEA/TYPEI/TYPEN/TYPEIS/TYPENS/TYPEN24 column of the `rtrv-tt` output. See Note 2.

TTN – The translation type name from the TTN column of the `rtrv-tt` output.

GTA – 1 - 21 digits or 1 - 21 hexadecimal digits

PC/PCA/PCI/PCN/PCN24 – See Note 1

SSN – 0 - 255

EGTA – 1 - 21 digits or 1 - 21 hexadecimal digits. Default = same as the **GTA** value

FORCE – yes, no. Default = no

LOOPSET – Loopset name from the `rtrv-loopset` output

GTMODID – GT modification identifier from the `rtrv-gtmod` output

MRNSET – MRN set ID from the `rtrv-mrn` output

MAPSET – MAP set ID from the `rtrv-map` output

CGGTMOD – yes, no. Default = no

Table 3-7 (Cont.) Add GTT Parameter Combinations

RI = GT XLAT= DPCNGT	RI = GT XLAT= DPCSSN	RI = GT XLAT= DPC	RI = SSN XLAT= DPCSSN	RI = SSN XLAT= DPC
-------------------------------------	-------------------------------------	------------------------------	--------------------------------------	-------------------------------

Notes:

- a. The `pc/pca/pci/pcn/pcn24` parameters are used to assign either ANSI, ITU-I, ITU-I spare, 14-bit ITU-N, 14-bit ITU-N spare, or 24-bit ITU-N point codes to the global title translation (GTT).
 - `pc/pca` = ANSI point code
 - `pci` = ITU-I or ITU-I spare point code
 - `pcn` = 14-bit ITU-N or 14-bit ITU-N spare point code
 - `pcn24` = 24-bit ITU-N point code.
- b. The `type/typea/typei/typen/typeis/typens/typen24` parameters specify the translation type and the network type of the translation type.
 - `type/typea` = ANSI translation type
 - `typei` = ITU-I translation type
 - `typen` = ITU-N translation type
 - `typeis` = ITU-I spare translation type
 - `typens` = ITU-N spare translation type
 - `typen24` = ITU-N24 translation type
- c. The domain (ANSI or ITU) of the point code and translation type must be the same, unless the ANSI/ITU SCCP Conversion feature is enabled. If the ANSI/ITU SCCP Conversion feature is enabled, a GTT may contain an ANSI point code and an ITU translation type, or an ITU point code and an ANSI translation type. Whether the ANSI/ITU SCCP Conversion feature is enabled or not, the translation type parameters `typei`, `typen`, or `typen24` can be specified with either the `pci`, `pcn`, or `pcn24` parameters.
- d. If the VGTT feature is on, shown by the `VGTT = on` entry in the `rtrv-feat` output, the translation type can contain a maximum of 10 different length GTAs. If the Support for 16 GTT Lengths in VGTT feature is enabled and turned on, shown by the `VGTT with 16 GTT lengths` entry in the `rtrv-ctrl-feat` output, the translation type can contain maximum of 16 different length GTAs. If the maximum number of different GTA lengths is shown in the NDGT column of the `rtrv-tt` output, the length of the GTA must match any existing GTA assigned to the translation type.
- e. If the translation type contains less than the maximum number of different length GTAs, the length of the GTA can be from 1 to 21 digits.
- f. If the VGTT feature is off, the length of the GTA must contain the number of digits defined by the NDGT field of the `rtrv-tt` output.
- g. The `cggtmod` parameter can be specified only if the AMGTT or AMGTT CgPA Upgrade feature is enabled.
- h. If the point code is the EAGLE's point code, then the `xlat` parameter value must be `dpcssn` and the `ri` parameter value must be `ssn`.
- i. The `mrnset` parameter can be specified only, and must be specified, if the Flexible GTT Load Sharing feature is enabled.
- j. If the `pc/pca/pci/pcn/pcn24` parameter value is not shown in the `rtrv-map` output, the `force=yes` parameter must be specified with the `ent-gtt` command.
- k. The `mapset` parameter can be specified only, and must be specified, if the Flexible GTT Load Sharing feature is enabled.

Table 3-7 (Cont.) Add GTT Parameter Combinations

RI = GT XLAT= DPCNGT	RI = GT XLAT= DPCSSN	RI = GT XLAT= DPC	RI = SSN XLAT= DPCSSN	RI = SSN XLAT= DPC
<p>l. Hexadecimal digits (0-9, a-f, A-F) can be specified for the <code>gta</code> or <code>egta</code> parameters only if the Hex Digit support for GTT feature is enabled.</p> <p>m. The <code>loopset</code> parameter can be specified only if the SCCP Loop Detection feature is enabled.</p> <p>n. Either the <code>type</code> parameter or the <code>ttn</code> parameter must be specified.</p> <p>o. If the <code>type</code> parameter is not specified, the translation type name must be assigned to a translation type in the database. This can be verified with the <code>rtrv-tt</code> command.</p> <p>p. If the <code>type</code> and <code>ttn</code> parameters are specified, the specified translation type must be in the database and the specified translation type name must be assigned to the translation type.</p> <p>q. The end global title address (<code>egta</code>) must be greater than or equal to the start global title address (<code>gta</code>) and its length must be equal to the start global title address.</p> <p>r. A GT modification identifier entry can contain the <code>ngti=4</code> parameter value only if the point code value in the GTT entry is an ITU point code.</p> <p>s. Since NTT is no longer dependent on XLAT=DPCNGT, the functionality of XLAT=DPCNGT and XLAT=DPC shall be the same.</p>				

- 28.** Verify the changes using the `rtrv-gtt` command with the translation type parameter and value, and the `gta` parameter value specified in 27. If the `num` parameter is specified with the `rtrv-gtt` command, and the value of the `num` parameter is greater than 1000, the `force=yes` parameter must be specified with the `rtrv-gtt` command.

For this command, enter these commands.

```
rtrv-gtt:typea=5:gta=910460
```

This is an example of the possible output.

```
rlghncxa03w 10-07-25 09:46:31 GMT EAGLE5 42.0.0
TYPEA  TTN          NDGT
5      scp1        6

GTT TABLE IS (27000 of 269999) 10 % FULL

START GTA          END GTA          XLAT  RI      PC
910460            919460          DPCNGT GT
007-007-007
      MAPSET=114  SSN=---  GTMODID=modid2  CGGTMOD = YES
      LOOPSET = none
```

Command Retrieved 1 Entries

```
rtrv-gtt:typea=10:gta=615370
```

This is an example of the possible output.

```
rlghncxa03w 10-07-25 09:46:31 GMT EAGLE5 42.0.0
TYPEA TTN      NDGT
10     scp2    6

GTT TABLE IS (27000 of 269999) 10 % FULL

START GTA          END GTA          XLAT  RI    PC
615370            615380          DPCSSN SSN
003-003-003
      MAPSET=3      SSN=254  GTMODID=-----  CGGTMOD = NO
      LOOPSET = none

Command Retrieved 1 Entries
```

```
rtrv-gtt:typea=15:gta=800
```

This is an example of the possible output.

```
rlghncxa03w 10-07-25 09:48:31 GMT EAGLE5 42.0.0
TYPEA TTN      NDGT
15     scp3    3

GTT TABLE IS (27000 of 269999) 10 % FULL

START GTA          END GTA          XLAT  RI    PC
800              900              DPC   SSN
005-005-005
      MAPSET=1      SSN=----  GTMODID=-----  CGGTMOD = NO
      LOOPSET = rtpl

Command Retrieved 1 Entries
```

29. Backup the new changes using the `chg-db:action=backup:dest=fixed` command. These messages should appear, the active Maintenance and Administration Subsystem Processor (MASP) appears first.

```
BACKUP (FIXED) : MASP A-Backup starts on active MASP.
BACKUP (FIXED) : MASP A-Backup on active MASP to fixed disk
complete.
BACKUP (FIXED) : MASP A-Backup starts on standby MASP.
BACKUP (FIXED) : MASP A-Backup on standby MASP to fixed disk
complete.
```

Figure 3-11 Add a Global Title Translation - Sheet 1 of 10

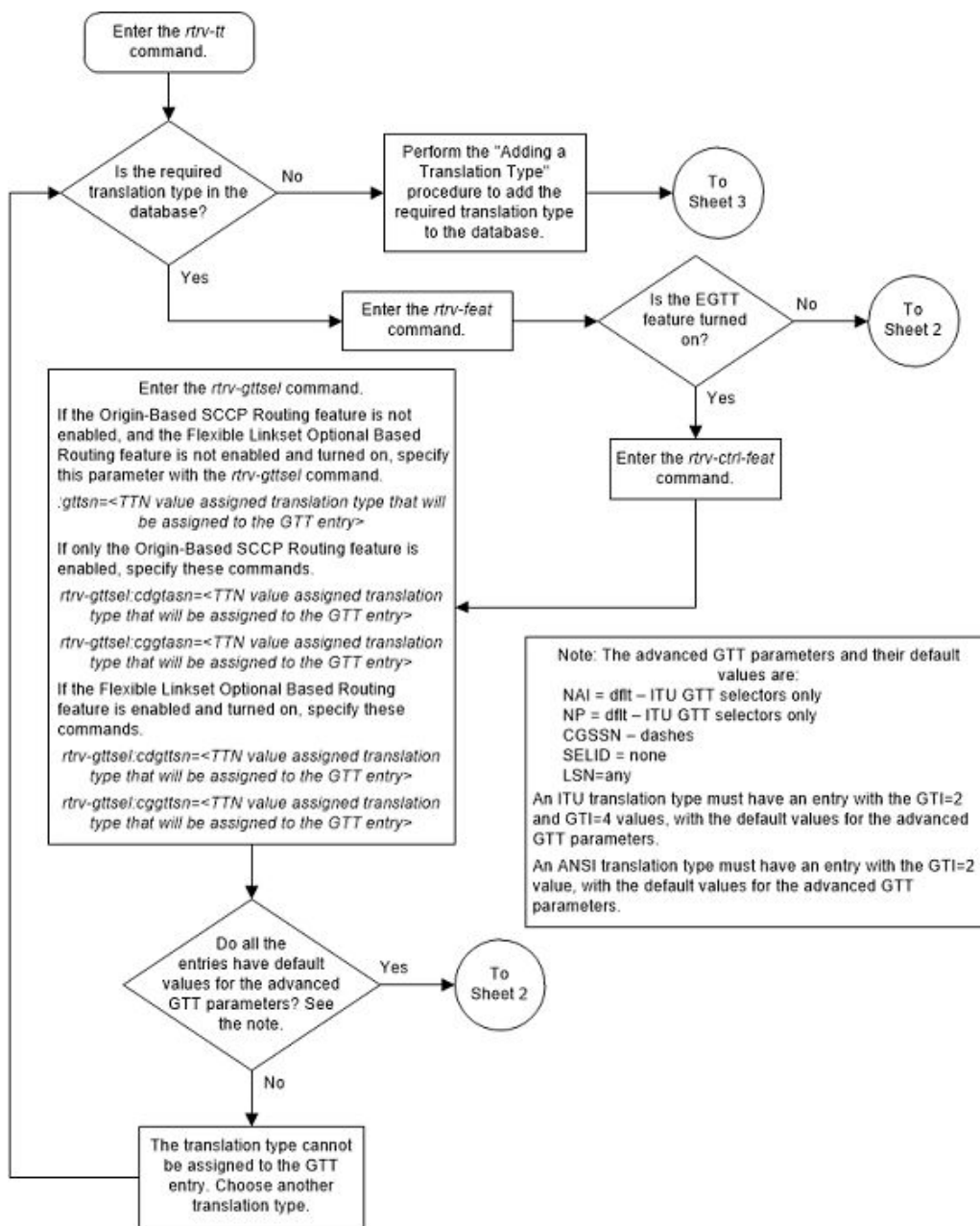

Figure 3-12 Add a Global Title Translation - Sheet 2 of 10

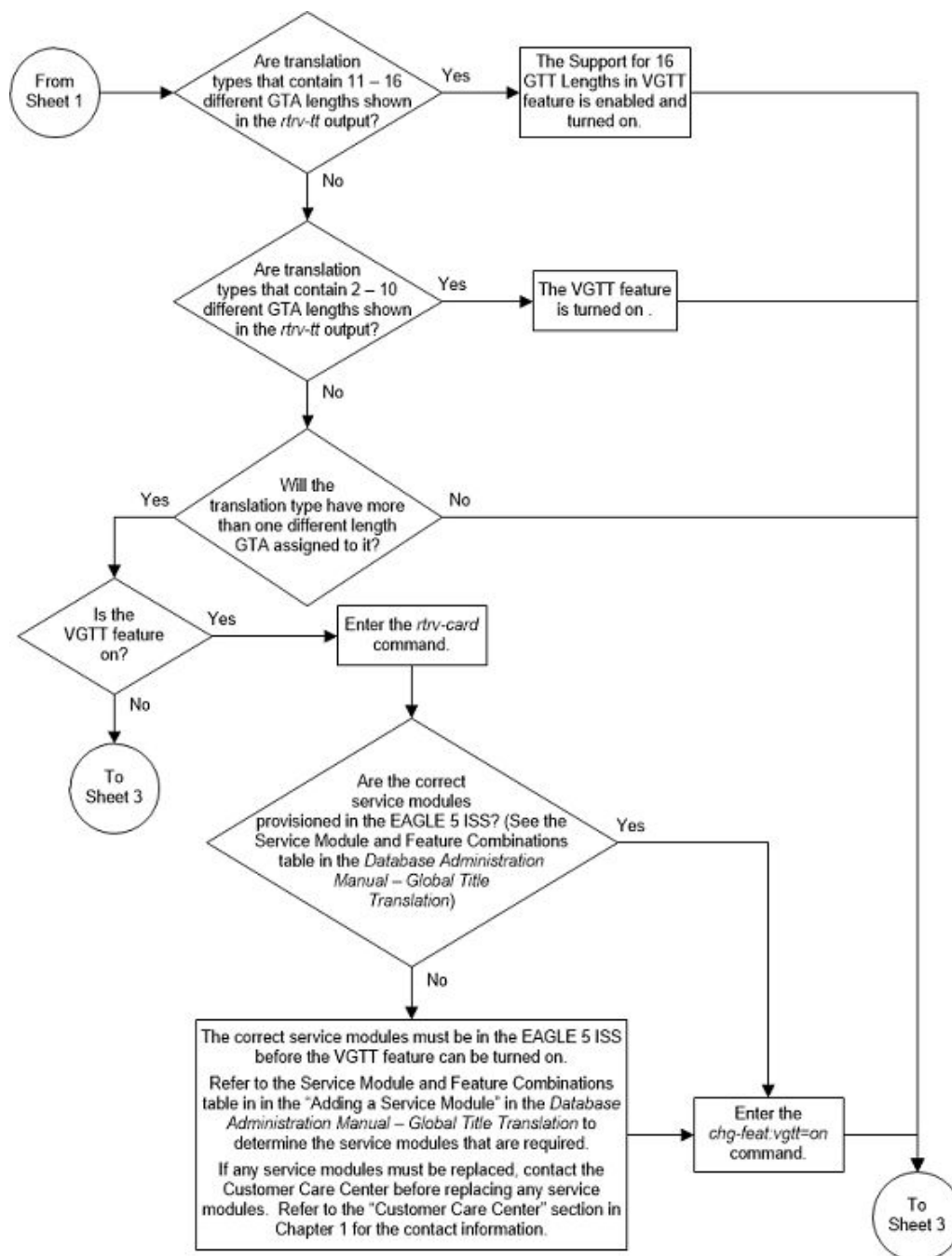

Figure 3-13 Add a Global Title Translation - Sheet 3 of 10

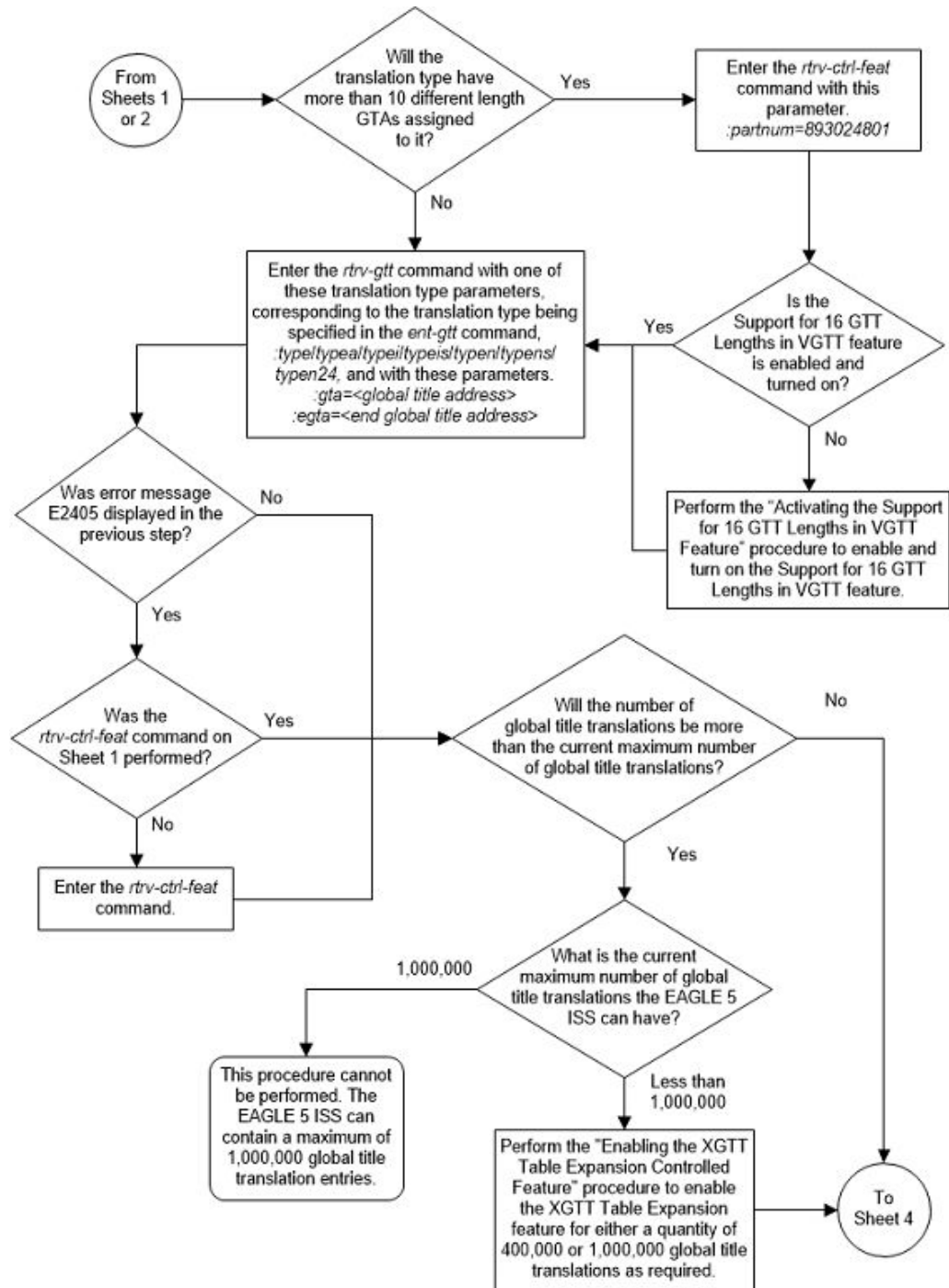

Figure 3-14 Add a Global Title Translation - Sheet 4 of 10

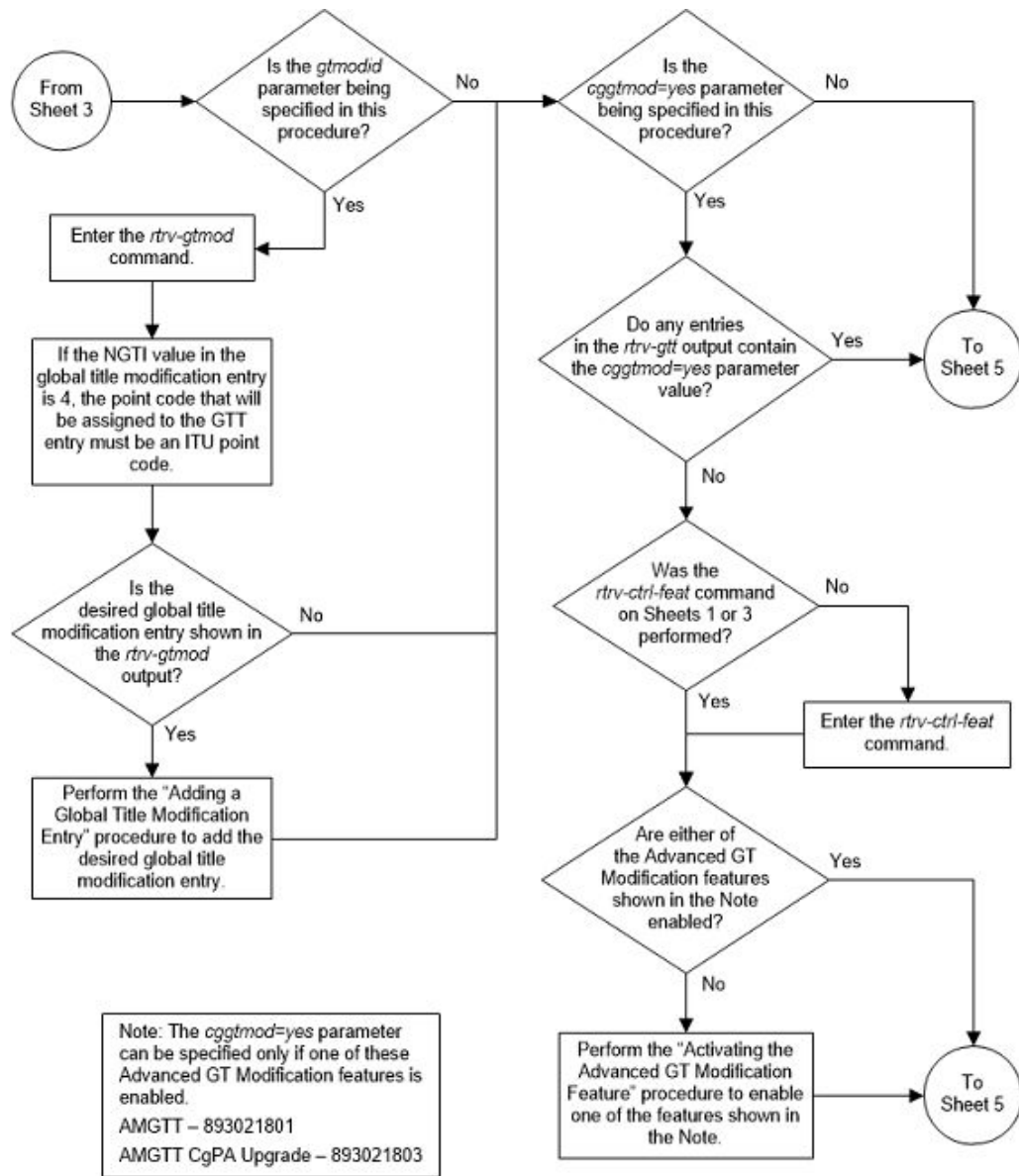

Figure 3-15 Add a Global Title Translation - Sheet 5 of 10

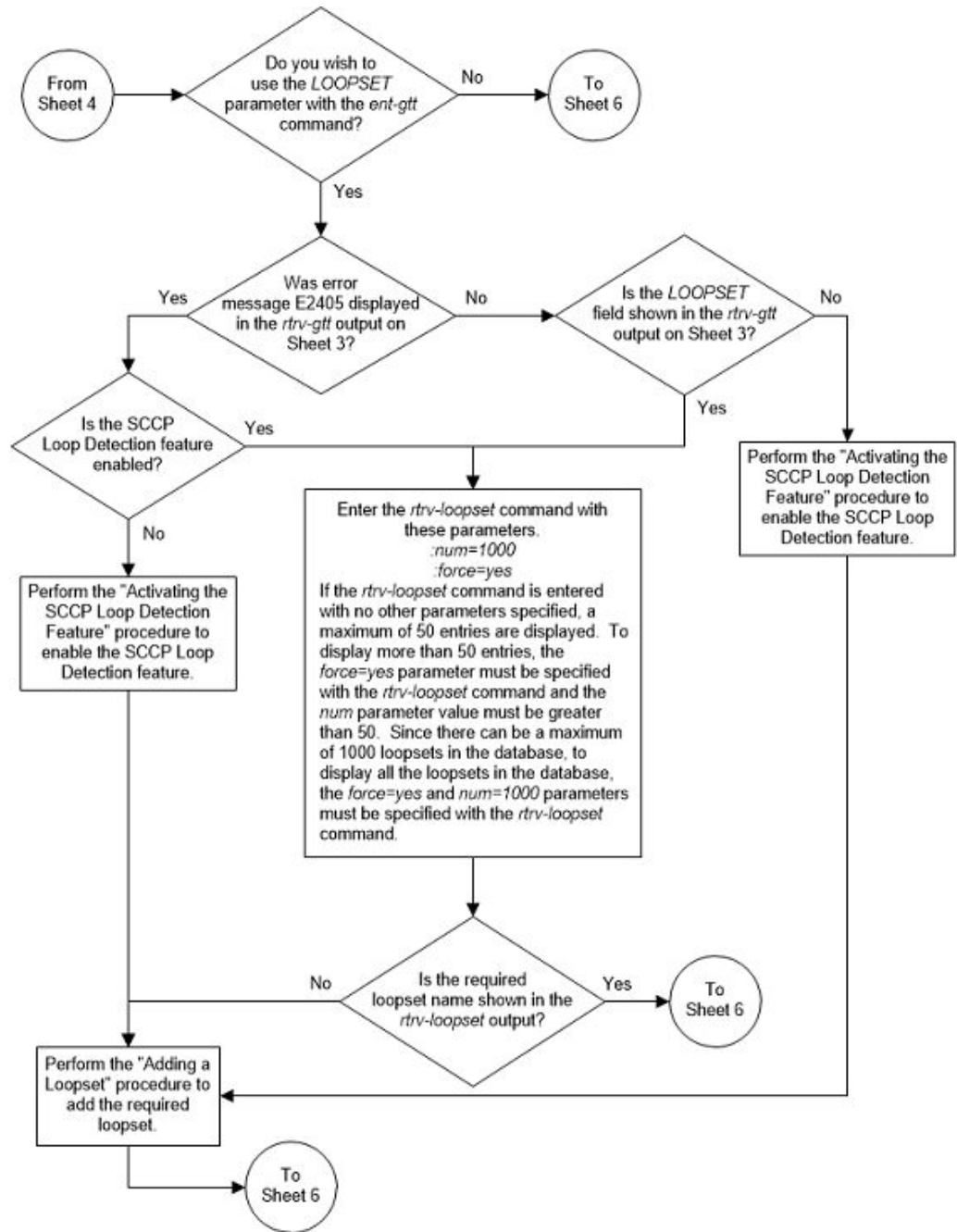

Figure 3-16 Add a Global Title Translation - Sheet 6 of 10

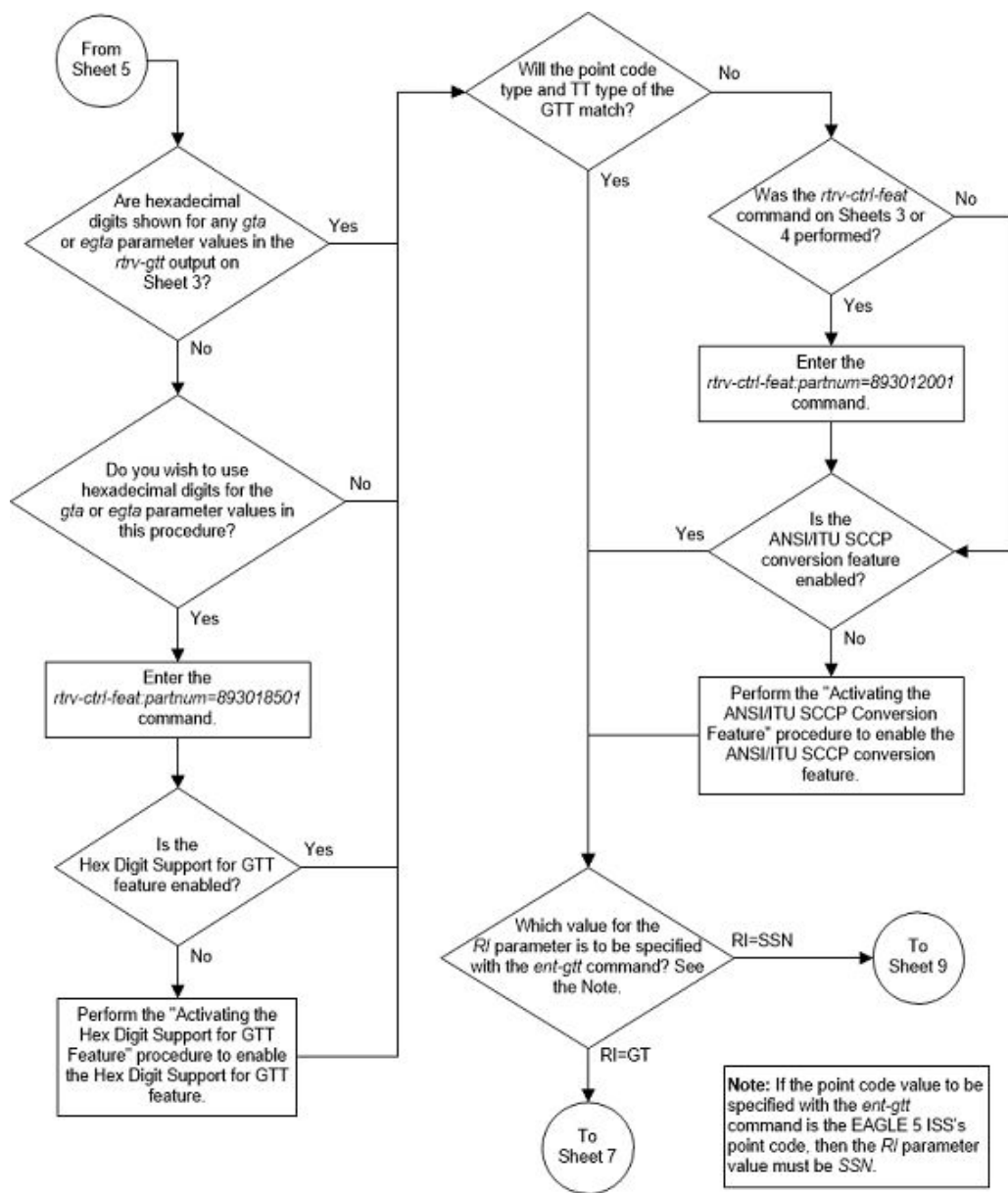

Figure 3-17 Add a Global Title Translation - Sheet 7 of 10

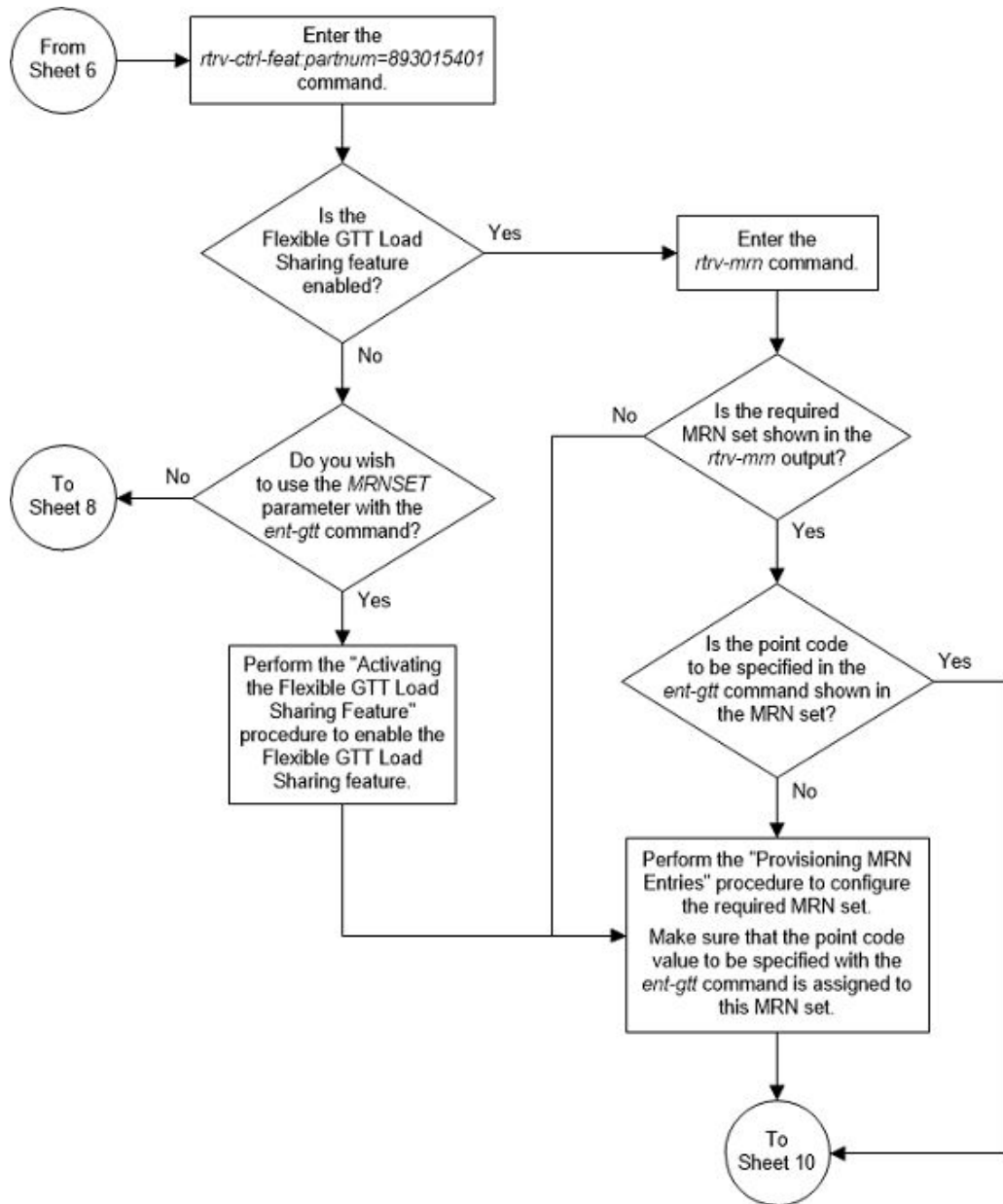

Figure 3-18 Add a Global Title Translation - Sheet 8 of 10

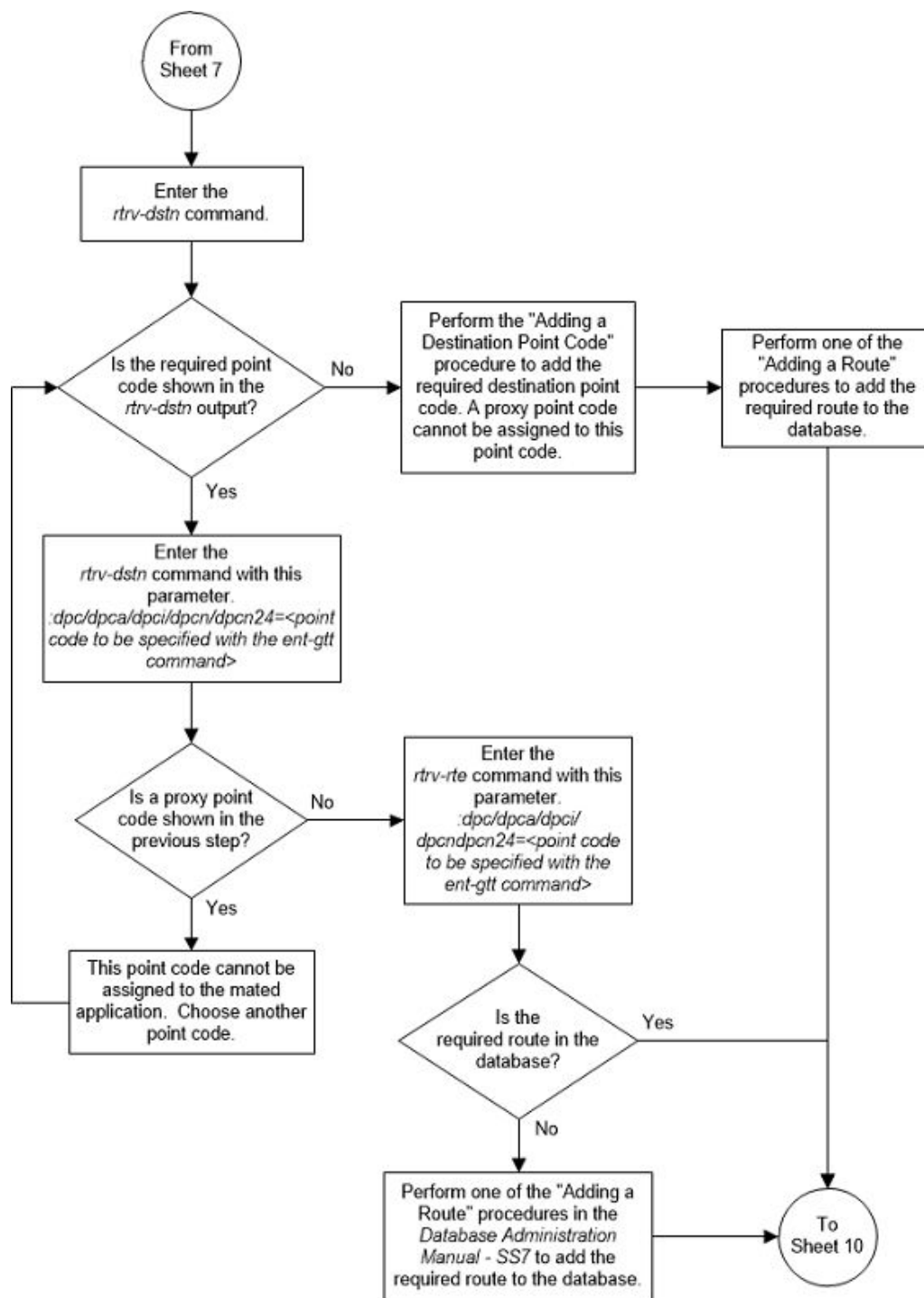

Figure 3-19 Add a Global Title Translation - Sheet 9 of 10

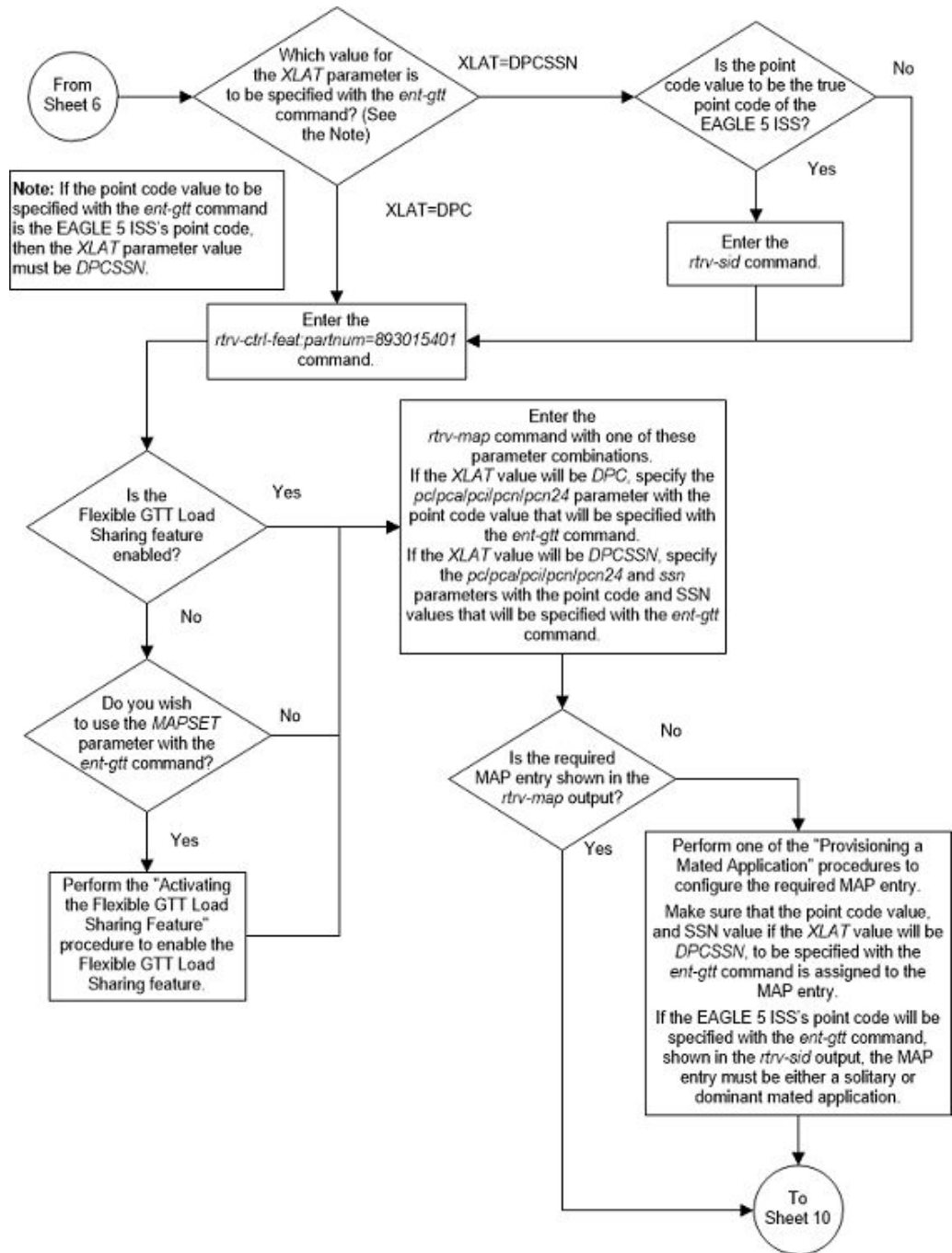
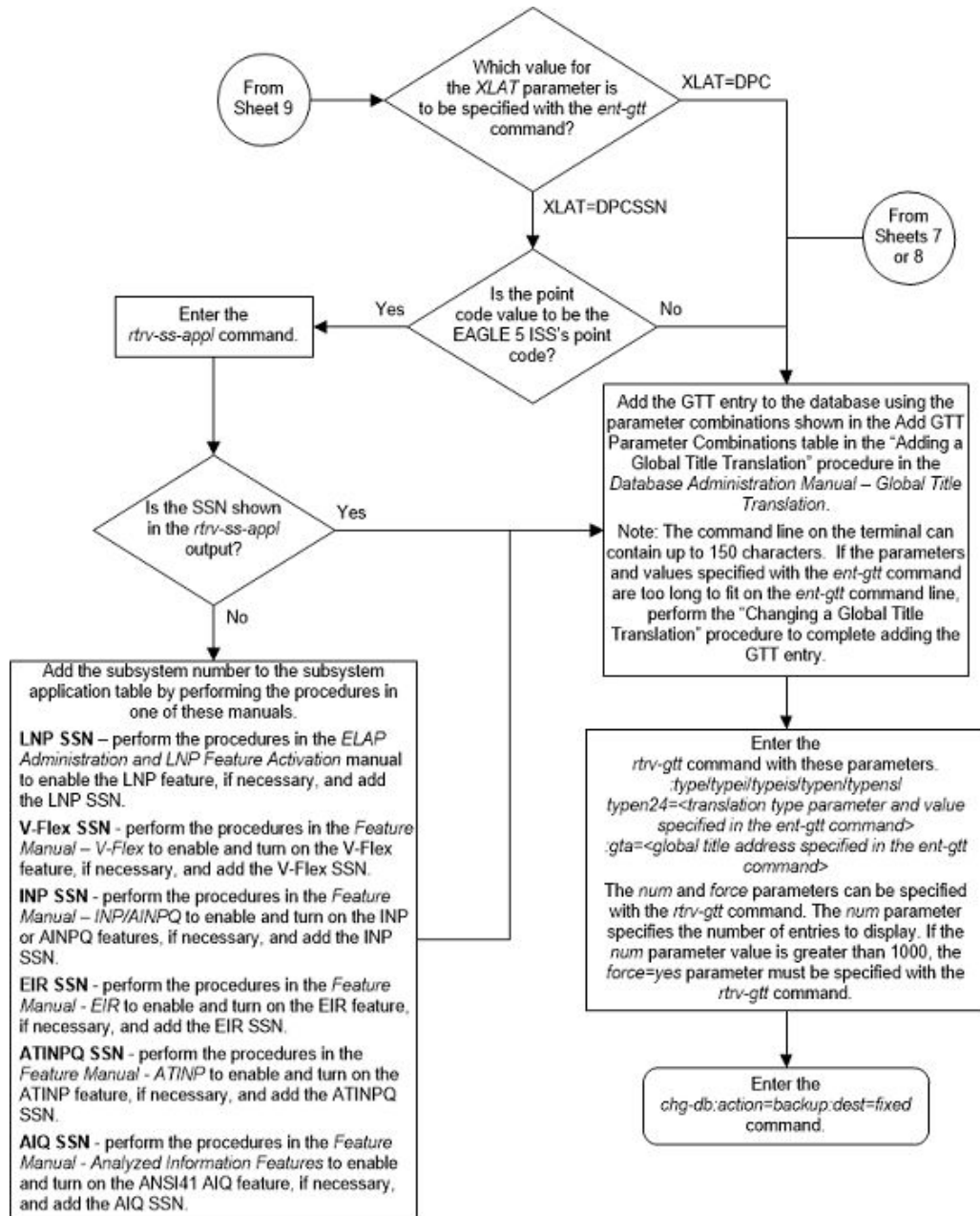

Figure 3-20 Add a Global Title Translation - Sheet 10 of 10



Removing a Global Title Translation

This procedure is used to remove a global title translation from the database using the `dlt-gtt` command.

The `dlt-gtt` command uses these parameters.

`:gta` – Global title start address – along with the `egta` parameter, identifies all valid global titles for the given translation type to translate to the given `pc` or `ssn` parameters. These are the non-SS7 addresses transmitted to the EAGLE for translation.

`:egta` – Global title end address – along with the `gta` parameter, identifies all valid global titles for the given translation type to translate to the given `pc` or `ssn` parameters. These are the non-SS7 addresses transmitted to the EAGLE for translation.

`:type/typea/typei/typeis/typen/typens/typen24` – The translation type and network type of that translation type.

- `:type` or `:typea` – an ANSI network
- `:typei` – an ITU international network
- `:typeis` – an ITU international spare network
- `:typen` – a 14-bit ITU national network.
- `:typens` – a 14-bit ITU national spare network.
- `:typen24` – a 24-bit ITU national network.

`:ttn` – The name of the global title translation type

If the translation type is defined as an alias, it cannot be used in the `dlt-gtt` command.

If the end of the global title address (`egta`) parameter is specified, the GTA and EGTA must have the same number of digits, but the EGTA must be larger than the GTA. The range, as specified by the start and end global title addresses, must be in the database for the specified translation type. Each range may be contained completely within a previously defined range, in which case splitting is performed. However, if the ranges overlap, splitting cannot occur, and the `dlt-gtt` command is rejected with this message.

The range of global title addresses, as specified by the start and end global title addresses, must be in the database for the specified translation type. The `gta` and `egta` parameter values must have the same number of digits, but the `egta` parameter value must be larger than the `gta` parameter value. Each range may be contained completely within a previously defined range, in which case splitting is performed. However, if the ranges overlap, splitting cannot occur, and the `dlt-gtt` command is rejected with this message.

```
E2401 Cmd Rej:GTA range overlaps a current range
```

Along with error message 2401, a list of the overlapped global title addresses is displayed as shown in the following example.

```
rlghncxa03w 07-05-24 08:29:15 GMT EAGLE5 37.0.0
The following GTA ranges overlap the input GTA range
```

START GTA	END GTA
8005550000	8005551999
8005552000	8005553999
8005554000	8005555999

```
DLT-GTT: MASP A - Command Aborted
```

For a range of global title addresses to be split, the new entry created by the split cannot increase the number of entries in the GTT table beyond the quantity shown in the `rtrv-gtt` output.

The length of the global title addresses specified by the `gta` or `egta` parameters must match the length of any existing global title addresses assigned to the specific translation type. The lengths are shown in the `START GTA` and `END GTA` fields of the `rtrv-gtt` command output, or in the `NDGT` field of the `rtrv-tt` command output. If the length of the global title address does not match one of the lengths already assigned to the translation type, the `dlt-gtt` command is rejected with this message.

```
E2960 Cmd Rej: The GTA length is not defined for the specified
TT
```

When the VGTT feature is on, up to 10 different length global title addresses can be assigned to a translation type. If the Support for 16 GTT Lengths in VGTT feature is enabled and turned on, up to 16 different length global title addresses can be assigned to a translation type. The length of the global title address is only limited by the range of values for the `gta` and `egta` parameters of the `ent-gtt` and `chg-gtt` commands, one to 21 digits, and by the global title addresses already assigned to the translation type. The `ndgt` parameter of the `ent-tt` command has no effect on the length of the global title address and cannot be used. If the `ndgt` parameter is specified with the `ent-tt` command and the VGTT feature is on, the `ent-tt` command is rejected with this message.

```
E4011 Cmd Rej: NDGT parameter is invalid for VGTT
```

If the Variable-length Global Title Translation Feature (VGTT) is on, or the Support for 16 GTT Lengths in VGTT feature is enabled and turned on, the `NDGT` field of the `rtrv-tt` command shows the different lengths of global title addresses assigned to a translation type, as shown in the following example.

```
rlghncxa03w 10-07-25 09:57:31 GMT EAGLE5 42.0.0
```

TYPEA	TTN	NDGT
1	lidb	6, 12, 15
2	c800	10
3	d700	6

ALIAS	TYPEA
50	3
65	3

TYPEI	TTN	NDGT
105	itudb	8

ALIAS	TYPEI
7	105

TYPEN	TTN	NDGT
120	dbitu	7

ALIAS	TYPEN
8	120

TYPEN24	TTN	NDGT
---------	-----	------

ALIAS	TYPEN24
-------	---------

TYPEIS	TTN	NDGT
--------	-----	------

```

ALIAS      TYPEIS
          TYPENS      TTN      NDGT
          ALIAS      TYPENS

```

In this example of the `rtrv-tt` command output, the ANSI translation type 1 contains three different length global title addresses; global title addresses containing six digits, 12 digits, and 15 digits.

When the VGTT feature is on, or the Support for 16 GTT Lengths in VGTT feature is enabled and turned on, and the last global title address of a particular length is deleted for the specified translation type, then that length is no longer supported. That length is not displayed in the `NDGT` field of the `rtrv-tt` command output. For example, if the last 6-digit global title address is deleted from ANSI translation type 1 (from the previous example), the `NDGT` field of the `rtrv-tt` command shows only the numbers 12 and 15 in the `NDGT` field indicating that ANSI translation type 1 contains only 12- and 15-digit global title addresses.

Canceling the `RTRV-GTT` Command

Because the `rtrv-gtt` command used in this procedure can output information for a long period of time, the `rtrv-gtt` command can be canceled and the output to the terminal stopped. There are three ways that the `rtrv-gtt` command can be canceled.

- Press the `F9` function key on the keyboard at the terminal where the `rtrv-gtt` command was entered.
- Enter the `canc-cmd` without the `trm` parameter at the terminal where the `rtrv-gtt` command was entered.
- Enter the `canc-cmd:trm=<xx>`, where `<xx>` is the terminal where the `rtrv-gtt` command was entered, from another terminal other than the terminal where the `rtrv-gtt` command was entered. To enter the `canc-cmd:trm=<xx>` command, the terminal must allow Security Administration commands to be entered from it and the user must be allowed to enter Security Administration commands. The terminal's permissions can be verified with the `rtrv-secu-trm` command. The user's permissions can be verified with the `rtrv-user` or `rtrv-secu-user` commands.

For more information about the `canc-cmd` command, go to *Commands User's Guide*.

1. Verify that the GTT feature is on, by entering the `rtrv-feat` command. If the GTT feature is on, the `GTT` field should be set to `on`.

Note:

The `rtrv-feat` command output contains other fields that are not used by this procedure. If you wish to see all the fields displayed by the `rtrv-feat` command, refer to the `rtrv-feat` command description in *Commands User's Guide*.

If the GTT feature is off, this procedure cannot be performed.

If the GTT feature is on, continue the procedure with [2](#).

2. Display the translation types in the database using the `rtrv-tt` command.

This is an example of the possible output.

```
rlghncxa03w 10-07-25 09:42:31 GMT EAGLE5 42.0.0
TYPEA      TTN      NDGT
1          lidb     5
2          c800    10
3          d700    6
5          scp1   6
10         scp2   6
15         scp3   3

ALIAS      TYPEA
30         5
40         10
50         3
65         3

TYPEI      TTN      NDGT
105        itudb   8

ALIAS      TYPEI
7          105

TYPEN      TTN      NDGT
120        dbitu   7

ALIAS      TYPEN
8          120

TYPEN24    TTN      NDGT

ALIAS      TYPEN24

TYPEIS     TTN      NDGT

ALIAS      TYPEIS

TYPENS     TTN      NDGT

ALIAS      TYPENS
```

If the EGTT feature is off, shown in [1](#), continue the procedure with [5](#).

If the EGTT feature is on, continue the procedure with [3](#).

3. Display the GTT set that contains the TTN value that is assigned to the GTT entry that is being removed. Enter the `rtrv-gttset` command with the `gttsn` parameter. The value of the `gttsn` parameter is the TTN value associated with the translation type, shown in [2](#), that is assigned to the GTT entry that is being removed.

For this example, enter this command.

```
rtrv-gttset:gttsn=scp2
```

This is an example of the possible output.

```
rlghncxa03w 10-07-11 18:54:54 GMT EAGLE5 42.0.0
```

```
GTTSN      NETDOM  SETTYPE  NDGT
scp2       ansi    CDGTA    6
```

GTT-SET table is (8 of 2000) 1% full.

If the NETDOM value of the GTT set is CROSS, the GTT entry cannot be removed with this procedure. Perform the [Removing Global Title Address Information](#) procedure to remove the GTT entry.

If the NETDOM value is ANSI or ITU, continue the procedure with 4.

4. Display the GTA entries that reference the TTN value that is assigned to the GTT entry that is being removed. Enter the `rtrv-gta` command with the `gttsn` parameter. The value of the `gttsn` parameter is the `gttsn` value that was specified in 3.

For this example, enter this command.

```
rtrv-gta:gttsn=scp2
```

This is an example of the possible output.

```
tekelecstp 10-07-12 07:48:31 EST 42.0.0
```

```
GTTSN      NETDOM  NDGT
d700       itu     6
```

GTA table is (27000 of 269999) 10% full.

```
START GTA END GTA  XLAT  RI      PCA
615370  615380  DPCSSN SSN    003-003-003
      SSN=254 CCGT=no
      GTMODID=----- TESTMODE=off
      ACTSN=----- PPMEASREQD= NO
423555  423600  DPCSSN SSN    004-003-003
      SSN=254 CCGT=no
      GTMODID=----- TESTMODE=off
      ACTSN=----- PPMEASREQD= NO
336200  336399  DPCSSN SSN    004-003-003
      SSN=254 CCGT=no
      GTMODID=----- TESTMODE=off
      ACTSN=----- PPMEASREQD= NO
```

Command Retrieved 3 Entries

If the XLAT value of the entry that you wish to remove is NONE, the GTT entry cannot be removed with this procedure. Perform the [Removing Global Title Address Information](#) procedure to remove the GTT entry.

If the XLAT value of the entry that you wish to remove is either DPC, DPCNGT, or DPCSSN, continue the procedure by performing one of these steps.

- If the range of global title addresses will not be split in this procedure, continue the procedure with 7.
 - If the range of global title addresses will be split in this procedure, continue the procedure with 6.
5. Display the global title translations in the database using the `rtrv-gtt` command specifying a translation type, translation type name, or both from the `rtrv-tt` command output shown in 2.

For this example, enter this command.

```
rtrv-gtt:typea=10
```

This is an example of the possible output.

```
rlghncxa03w 10-07-25 09:43:31 GMT EAGLE5 42.0.0
TYPEA TTN      NDGT
10     scp2     6

GTT TABLE IS 10 % FULL (27000 of 269999)

START GTA          END GTA          XLAT  RI      PC
615370            615380          DPCSSN SSN
003-003-003
      SSN=254  GTMODID=-----
423555            423600          DPCSSN SSN
004-003-003
      SSN=254  GTMODID=-----
336200            336399          DPCSSN SSN
004-005-003
      SSN=254  GTMODID=-----
```

Command Retrieved 3 Entries

Continue the procedure by performing one of these steps.

- If the range of global title addresses will not be split in this procedure, continue the procedure with 7.
 - If the range of global title addresses will be split in this procedure, continue the procedure with 6.
6. If the `rtrv-gtt` output in 5 shows that the maximum number of global title addresses is 1,000,000, do not perform this step. The range of global title addresses cannot be split. Continue the procedure with 7.

If the `rtrv-gtt` output in 5 shows that the maximum number of global title addresses is either 269,999 or 400,000, and the number of global title addresses will not increase the number beyond the quantity shown in the `rtrv-gtt` output in 5 when the range of global title addresses is split, do not perform this step. Continue the procedure with 7.

If the `rtrv-gtt` output in 5 shows that the maximum number of global title addresses is either 269,999 or 400,000, and the number of global title addresses will be more than the maximum number of global title addresses when the range of global title addresses is split, perform [Enabling the XGTT Table Expansion Feature](#) to enable the XGTT Table Expansion feature for either 400,000 or 1,000,000 global title addresses as required. Then continue the procedure with 7.

7. Display the GTT paths that reference the GTA and TTN values contained in the GTT entry that is being removed. Enter the `rtrv-gttapath` with these parameters.
 - `cdgttsn` - the TTN value shown in the `rtrv-gtt` output in 5, or GTTSN value shown in the `rtrv-gta` output in 4.
 - `cdgta` - the START GTA value shown in the `rtrv-gtt` output in 5 or in the `rtrv-gta` output in 4.

For this example, enter this command.

```
rtrv-gttapath:cdgttsn=scp2:cdgta=615370
```

This is an example of the possible output.

```
rlghncxa03w 10-07-25 09:43:31 GMT EAGLE5 42.0.0

GTTPN   OPGTTSN           CGGTTSN           CDGTTSN
-----
path1   -----           -----           scp2
        CDGTA = 615370                ECDGTA = 615380
```

GTT-PATH table is (10 of 10000) 1% full.

If entries are displayed, continue the procedure by performing one of these procedures.

- Perform the [Removing a GTT Action Path Entry](#) to remove all the entries shown in this step.
- Perform the [Changing a GTT Action Path Entry](#) to change the `CDGTTSN` value to `none` or to another GTT set for all the entries shown in this step.

If no entries are displayed in this step, or if the GTT action paths have been removed or changed, continue the procedure with 8.

8. Remove the global title translation from the database using the `dlt-gtt` command.

For this example, enter this command.

```
dlt-gtt:typea=10:ttn=scp2:gta=615370:egta=615380
```

This message should appear.

```
rlghncxa03w 10-07-25 09:44:31 GMT EAGLE5 42.0.0
DLT-GTT: MASP A - COMPLTD
```

9. Verify the changes using the `rtrv-gtt` command specifying the translation type, translation type name, or both used in 8.

For this example, enter this command.

```
rtrv-gtt:typea=10
```

This is an example of the possible output.

```
rlghncxa03w 10-07-25 09:43:31 GMT EAGLE5 42.0.0
TYPEA TTN NDGT
10 scp2 6

GTT TABLE IS 10 % FULL (26999 of 269999)

START GTA END GTA XLAT RI PC
423555 423600 DPCSSN SSN
004-003-003
SSN=254 GTMODID=-----
336200 336399 DPCSSN SSN
004-005-003
SSN=254 GTMODID=-----

Command Retrieved 2 Entries
```

If all the entries for the translation type have been removed in 8, then this message should appear.

```
E2466 Cmd Rej: Translation TYPE specified does not exist
```

10. Backup the new changes using the `chg-db:action=backup:dest=fixed` command.

These messages should appear, the active Maintenance and Administration Subsystem Processor (MASP) appears first.

```
BACKUP (FIXED) : MASP A - Backup starts on active MASP.
BACKUP (FIXED) : MASP A - Backup on active MASP to fixed disk
complete.
BACKUP (FIXED) : MASP A - Backup starts on standby MASP.
BACKUP (FIXED) : MASP A - Backup on standby MASP to fixed disk
complete.
```

Figure 3-21 Remove a Global Title Translation - Sheet 1 of 2

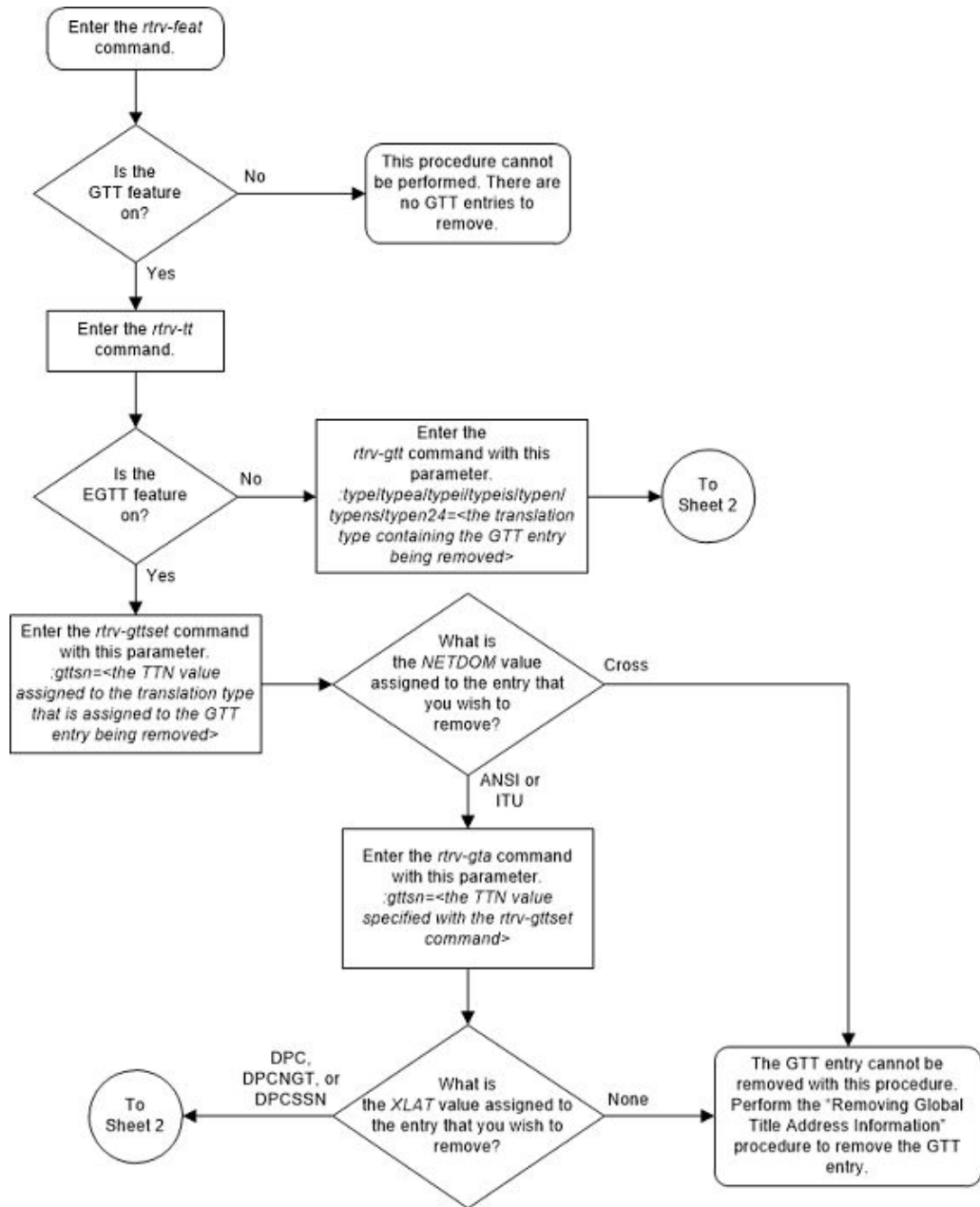
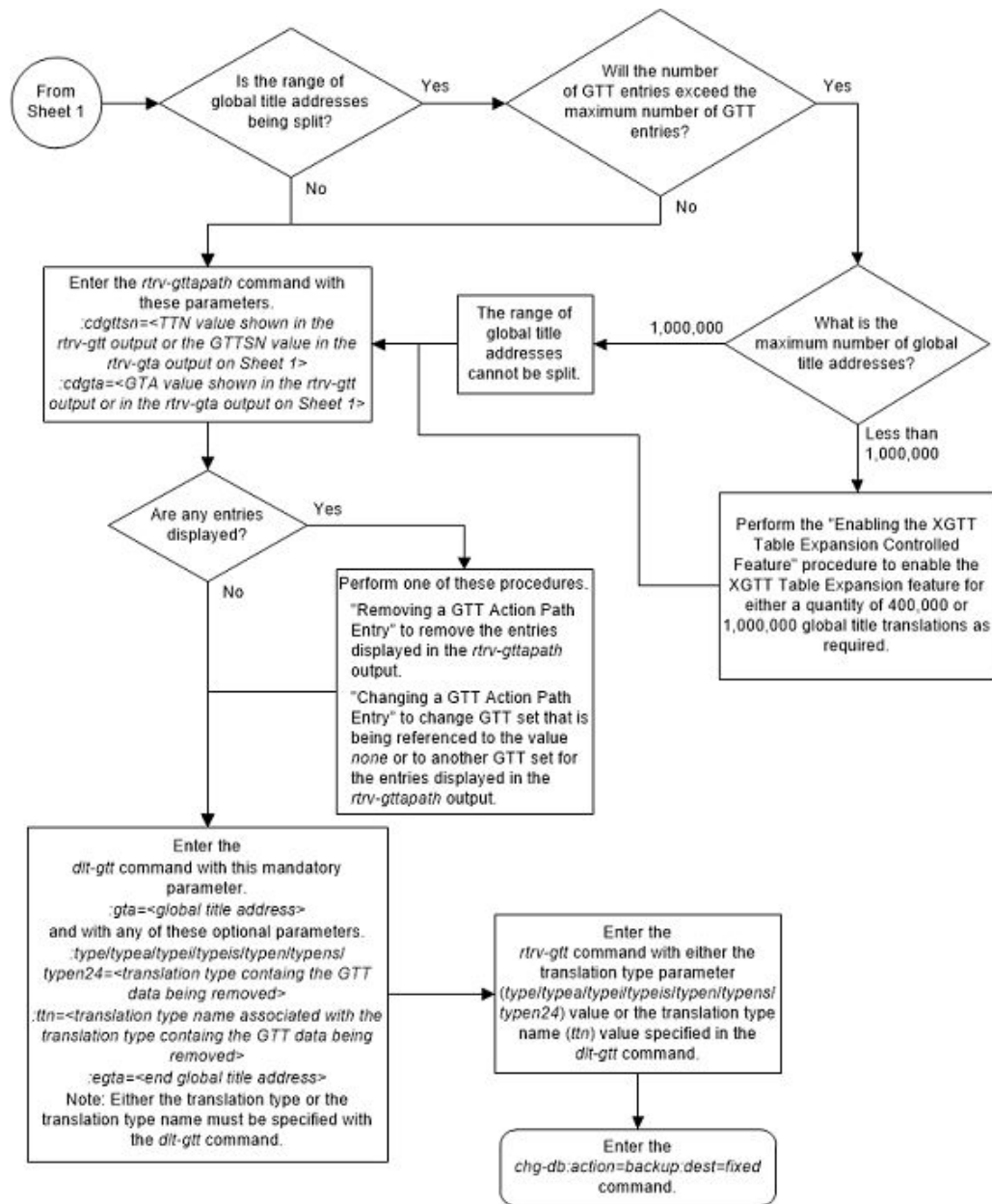

Figure 3-22 Remove a Global Title Translation - Sheet 2 of 2



Changing a Global Title Translation

This procedure is used to change the routing objects for messages requiring global title translation in the database using the `chg-gtt` command.

The `chg-gtt` command uses these parameters.

`:gta` – Global title start address – along with the `egta` parameter, identifies all valid global titles for the given translation type to translate to the given `pc` or `ssn` parameters. These are the non-SS7 addresses transmitted to the STP for translation.

`:type/typeea/typeei/typeeis/typen/typens/typen24` – The translation type and network type of the translation type that is being assigned to the global title translation. The value of this parameter is shown in the `rtrv-tt` output and provisioned in the [Adding a Translation Type](#) procedure.

`:ttn` – The name of the global title translation type

`:egta` – Global title end address. This parameter, along with the `gta` parameter, identifies all valid global titles for the given translation type to translate to the given `pc` or `ssn` parameters. These are the non-SS7 addresses transmitted to the STP for translation.

`:xlat` – Translate indicator – defines the type of global title translation that is to be performed.

`:ri` – Route indicator – indicates whether a subsequent global title translation is required.

`:pc/pca/pci/pcn/pcn24` – The point code of the signaling point that is to receive the message.

 **Note:**

See Chapter 2, Configuring Destination Tables, in *Database Administration - SS7 User's Guide* for a definition of the point code types that are used on the EAGLE and for a definition of the different formats that can be used for ITU national point codes.

`:ssn` – Subsystem number – identifies the subsystem address that is to receive the message.

`:gtmodid` - the name of the GT modification identifier shown in the `rtrv-gtmod` output and provisioned in the [Adding Global Title Modification Information](#) procedure. The GT modification identifier contains the information to modify the numbering plan, nature of address indicator, and the prefix or suffix digits in the called party address or calling party address portion of outbound MSUs.

`:mrnset` – The MRN set ID, shown in the `rtrv-mrn` command. The `mrnset` parameter can be specified only if the Flexible GTT Load Sharing feature is enabled. If the Flexible GTT Load Sharing feature is enabled and the `ri` parameter value will be `ri=gt` when this procedure is completed, and the original global title translation being changed in this procedure did not have an MRN set ID assigned to it, the `mrnset` parameter must be specified with the `chg-gtt` command. The MRN set ID assigned to the global title translation in this step must contain the point code value that will be assigned to the global title translation being changed in this step.

`:mapset` – The MAP set ID, shown in the `rtrv-mrn` command. The `mapset` parameter can be specified only if the Flexible GTT Load Sharing feature is enabled. If the Flexible GTT Load Sharing feature is enabled and the `ri` parameter value will be `ri=ssn` when this procedure is completed, and the original global title translation being changed in this procedure did not have an MAP set ID assigned to it, the `mapset` parameter must be specified with the `chg-gtt` command. The MAP set ID assigned to the global title translation in this step must contain the point code and SSN values that will be assigned to the global title translation being changed in this step.

The status of the Flexible GTT Load Sharing feature is shown in the `rtrv-ctrl-feat` output. To enable the Flexible GTT Load Sharing feature, perform the [Activating the Flexible GTT Load Sharing Feature](#) procedure.

`:loopset` - The value of this parameter is the name of the loopset that is assigned to the GTT. This parameter can be specified only if the SCCP Loop Detection feature is enabled. Enter the `rtrv-loopset` command to verify that the SCCP Loop Detection feature is enabled. Perform the [Activating the SCCP Loop Detection Feature](#) procedure, if necessary.

`:cggtmod` - The calling party GT modification indicator. This parameter specifies whether or not calling party global title modification is required. The values for this parameter are `yes` (calling party global title modification is required) or `no` (calling party global title modification is not required). This parameter can be specified only if the AMGTT or AMGTT CgPA Upgrade feature is enabled. Enter the `rtrv-ctrl-feat` command to verify that either the AMGTT or AMGTT CgPA Upgrade feature is enabled. If the AMGTT or AMGTT CgPA Upgrade feature is not enabled, perform the [Activating the Advanced GT Modification Feature](#) procedure to enable the required feature.

`:split` - Split or change the range of global title addresses. If the `split=yes` parameter is specified, the existing range of global title addresses is split based on the values of the `gta` and `egta` parameters. New entries are created in the global title translation table for each new range created by the `split` parameter. The attributes of each new entry, other than the range of global title addresses, are the same as the original global title translation entry, if these values are not changed when the `chg-gtt` command is executed. If other attributes are changed when the `chg-gtt` command is executed, the changed values are in each new entry created by the `split` parameter.

If the `split=no` parameter is specified, the range of global title addresses is replaced with the new range of global title addresses specified by the `gta` and `egta` parameters.

The default value for the `split` parameter is `yes`.

Caution:

Changes to the range of global title addresses occur only if the both the `gta` and `egta` parameters are specified and the values for either of these parameters, or both parameters are different from the original values in the global title translation. If the `gta` and `egta` parameters are specified for the global title translation being changed, and you do not wish to change either of these values, make sure the `gta` and `egta` values shown in the `rtrv-gtt` output for the global title translation being changed are specified in the `chg-gtt` command.

The following examples illustrate how the `split` parameter works and ranges of global title addresses can be changed.

A global title translation entry in the database contains this range of global title addresses, 5556000 - 5558000.

```
rlghncxa03w 10-07-25 09:45:31 GMT EAGLE5 42.0.0

TYPEA  TTN      NDGT
15     tst1     7

GTT TABLE IS      (27000 of 269999)      10 % FULL

START GTA          END GTA          XLAT  RI      PC
5556000           5558000         DPCSSN GT      003-003-003
      MRNSET=114  SSN=254  GTMODID=-----  CGGTMOD = NO
```

Command Retrieved 1 Entries

The global title translation is changed with a new range of global title addresses, 5556800 - 5559000, and with the `split=no` parameter.

```
chg-gtt:ttn=tst1:gta=5556800:egta=5559000:split=no
```

The range of global title addresses is changed to 5556800 - 5559000.

```
rlghncxa03w 10-07-25 09:45:31 GMT EAGLE5 42.0.0

TYPEA  TTN      NDGT
15     tst1     7

GTT TABLE IS      (27000 of 269999)      10 % FULL

START GTA          END GTA          XLAT  RI      PC
5556800           5559000         DPCSSN GT      003-003-003
      MRNSET=114  SSN=254  GTMODID=-----  CGGTMOD = NO
```

Command Retrieved 1 Entries

In this example, the range of global title addresses is made smaller by specifying the range of global title addresses 5556500 - 5557500, and with the `split=no` parameter.

```
chg-gtt:ttn=tst1:gta=5556500:egta=5557500:split=no
```

```
rlghncxa03w 10-07-25 09:45:31 GMT EAGLE5 42.0.0

TYPEA  TTN      NDGT
15     tst1     7

GTT TABLE IS      (27000 of 269999)      10 % FULL

START GTA          END GTA          XLAT  RI      PC
5556500           5557500         DPCSSN GT      003-003-003
      MRNSET=114  SSN=254  GTMODID=-----  CGGTMOD = NO
```

Command Retrieved 1 Entries

In this next example, the range of global title addresses is split with the `gta=5556900` and `egta=5557000` defining where the splits occur.

```
chg-gtt:ttn=tst1:gta=5556900:egta=5557000
```

Since the default value for the `split` parameter is `yes`, the `split=yes` parameter does not have to be specified to split the range of global title addresses. When the `chg-gtt` command is entered, three new global title translation entries with the new global title address ranges are created, and the original global title translation entry is removed from the database. Since the `gta` and `egta` parameter values specified in this example are within the original range of global title addresses, the original range of global title addresses is split into three new ranges. The `START GTA` value of the first new range is the original `START GTA` value and the `END GTA` value is the `gta` parameter value minus one. The `START GTA` value of the second new range is the `gta` parameter value and the `END GTA` value is the `egta` parameter value. The `START GTA` value of the third new range is the `egta` parameter value plus 1 and the `END GTA` value is the original `END GTA` value.

```
rlghncxa03w 10-07-25 09:45:31 GMT EAGLE5 42.0.0
TYPEA TTN      NDGT
15     tst1     7

GTT TABLE IS      (27000 of 269999)      10 % FULL
START GTA          END GTA          XLAT RI      PC
5556000           5556899           DPCSSN GT    003-003-003
      MRNSET=114  SSN=254  GTMODID=-----  CGGTMOD = NO
```

Command Retrieved 1 Entries

```
rlghncxa03w 10-07-25 09:45:31 GMT EAGLE5 42.0.0
TYPEA TTN      NDGT
15     tst1     7

GTT TABLE IS      (27000 of 269999)      10 % FULL
START GTA          END GTA          XLAT RI      PC
5556900           5557000           DPCSSN GT    003-003-003
      MRNSET=114  SSN=254  GTMODID=-----  CGGTMOD = NO
```

Command Retrieved 1 Entries

```
rlghncxa03w 10-07-25 09:45:31 GMT EAGLE5 42.0.0
TYPEA TTN      NDGT
15     tst1     7

GTT TABLE IS      (27000 of 269999)      10 % FULL
START GTA          END GTA          XLAT RI      PC
5557001           5558000           DPCSSN GT    003-003-003
      MRNSET=114  SSN=254  GTMODID=-----  CGGTMOD = NO
```

Command Retrieved 1 Entries

In this next example, the global title translation containing the range of global title addresses 5557001 - 5558000 is split into two new ranges with the `gta=5557501` and `egta=5558000` defining where the split occurs.

```
chg-gtt:ttn=tst1:gta=5557501:egta=5558000:split=yes
```

When the `chg-gtt` command is entered, two new global title translation entries with the new global title address ranges are created, and the original global title translation entry is removed from the database. The `START GTA` value of the first new range is the original `START GTA` value and the `END GTA` value is the `gta` parameter value minus one. The `START GTA` value of the second new range is the `gta` parameter value and the `END GTA` value is the `egta` parameter value. In this example, the `egta` parameter is also the original `END GTA` value.

```
rlghncxa03w 10-08-25 09:45:31 GMT EAGLE5 42.0.0
TYPEA TTN      NDGT
15     tst1     7

GTT TABLE IS      (27000 of 269999)      10 % FULL

START GTA          END GTA          XLAT  RI      PC
5557001           5557500           DPCSSN GT    003-003-003
      MRNSET=114   SSN=254  GTMODID=-----  CGGTMOD = NO
```

Command Retrieved 1 Entries

```
rlghncxa03w 10-07-25 09:45:31 GMT EAGLE5 42.0.0
TYPEA TTN      NDGT
15     tst1     7

GTT TABLE IS      (27000 of 269999)      10 % FULL

START GTA          END GTA          XLAT  RI      PC
5557501           5558000           DPCSSN GT    003-003-003
      MRNSET=114   SSN=254  GTMODID=-----  CGGTMOD = NO
```

Command Retrieved 1 Entries

The range of global title addresses can be changed so long as the new range of global title addresses does not overlap an existing range of global title addresses.

For example, using the range of global title addresses from the previous examples, 5556000 - 5558000, you wish to extend the range of global title addresses to 5556000 - 5559000. The range of global title addresses can be extended to 5559000 by specifying the `egta=5559000` and `split=no` parameters with the `chg-gtt` command. However, if another range of global title addresses begins with the value 5558500, the `egta=5559000` parameter cannot be specified with the `chg-gtt` command as the new range created with the `egta=5559000` parameter would overlap the range of global title addresses beginning with the value 5558500. In this situation, the maximum value for the `egta` parameter would be 5558499.



Note:

The command line on the terminal can contain up to 150 characters. If the parameters and values specified with the `chg-gtt` command are too long to fit on the `chg-gtt` command line, perform the `chg-gtt` command as many times as necessary to complete the GTT entry.

The `XLAT` parameter does not have a SEAS equivalent. When global title translations are configured at the SEAS interface, the values for the SEAS parameters `RI`, `DPC`, and `SSN`, all mandatory parameters for the SEAS `ADD-GTT` and `CHG-GTT` commands, are converted to the EAGLE parameters and values shown in [Table 3-8](#).

Table 3-8 SEAS and Global Title Translation Parameter Conversion

SEAS GTT Parameters				GTT Parameters		
RI	DPC	SSN	XLAT	RI	PC/PCA	SSN
G	xxx-xxx-xxx	000	DPC	GT	xxx-xxx-xxx	Not Specified
D	xxx-xxx-xxx	002-255	DPCSSN	SSN	xxx-xxx-xxx	002-255
G	xxx-xxx-xxx	002-255	DPCSSN	GT	xxx-xxx-xxx	002-255
D	xxx-xxx-xxx	000	DPC	SSN	xxx-xxx-xxx	Not Specified

Notes:

- The SEAS `RI=G` parameter denotes global title routing, further global title translation is required.
- The SEAS `RI=D` parameter denotes DPC routing, no further global title translation is required.
- The `RI=GT` parameter denotes further global title translation is required and uses MTP routing.
- The `RI=SSN` parameter denotes final global title translation and uses MAP routing.
- The `XLAT=DPC` parameter indicates that the DPC & RI values in the MSU are to be replaced.
- The `XLAT=DPCSSN` parameter indicates that the DPC, RI, & SSN values in the MSU are to be replaced.
- The `XLAT=DPCNGT` parameter indicates that the DPC, RI, & TT values in the MSU are to be replaced.

The examples in this procedure are used to change the global title translation data for translation type 15 in the database.

If the translation type is defined as an alias, it cannot be used in the `chg-gtt` command.

If the translate indicator is equal to `dpc` (`xlat=dpc`) and the routing indicator is equal to `ssn` (`ri=ssn`), the point code and subsystem number specified in the `chg-gtt` command must be defined in the database as a mated application. Verify this by entering the `rtrv-map` command. If this point code and subsystem number is not defined as a mated application, perform one of these procedures to add the point code and subsystem number to the database as a mated application:

- [Provisioning a Solitary Mated Application](#)
- [Provisioning a Dominant Mated Application](#)

- [Provisioning a Load Shared Mated Application](#)
- [Provisioning a Combined Dominant/Load Shared Mated Application](#)

The point code and subsystem number do not have to be in the mated application table when the `chg-gtt` command is executed when these parameters are specified with the `chg-gtt` command.

- `ri=gt`
- `xlat=dpcssn` and `ri=ssn`

If the point code and subsystem are not in the mated application table when either of these parameters are specified with the `chg-gtt` command, the EAGLE creates a solitary mated application in the mated application table using the point code and subsystem values specified in the `chg-gtt` command.

If the `xlat=dpcssn` parameter is specified, the `ssn` parameter must be specified. Otherwise, the `ssn` parameter cannot be specified.

If a point code is the STP's True PC, then the value of the `XLAT` parameter must be set to `DPCSSN` and the value of the `RI` parameter must be set to `SSN`. If the `SSN` parameter is specified and a point code is the STP's True PC, then the subsystem number specified must exist in the `SS-APPL` table. This can be verified with the `rtrv-ss-appl` command. To execute the `rtrv-ss-appl` command, one or more features shown in [Table 3-9](#) must be enabled, and turned on if necessary. The `rtrv-ctrl-feat` output shows the required status of the features.

Table 3-9 Feature Status

Feature	Feature's Status	Entry Displayed in the <code>rtrv-ctrl-feat</code> Output
LNP	Enabled	The entry LNP TNs with a quantity greater than zero (0)
EIR	Enabled and Turned On	EIR
INP	Enabled and Turned On	INP
ANSI-41 INP Query	Enabled and Turned On	ANSI-41 INP Query
V-Flex	Enabled and Turned On	VFLEX
ATINP	Enabled	ATINP
ANSI41 AIQ	Enabled	ANSI41 AIQ

The point code specified in the `chg-gtt` command (`pc/pca`, `pci`, `pcn` or `pcn24`) must be defined in the routing table. For ANSI point codes (`pc/pca`), the point code specified in the `chg-gtt` command, must be a full point code. That point code can be defined as a full point code in the destination point code table, or can be a member of a cluster point code defined in the destination point code table. Cluster point codes or a network routing point codes cannot be specified with this command. The `rtrv-rte` command can be used to verify the point codes in the routing table. The point codes are shown in the `DPCA`, `DPCI`, `DPCN`, or `DPCN24` fields of the `rtrv-rte` command output. If the point code is not defined as a route, perform one of the Adding a Route procedures in *Database Administration – SS7 User's Guide* to define the point code as a route.

If the EAGLE's point code is specified with the `chg-gtt` command, then the `xlat=dpcssn` and `ri=ssn` parameters must be specified. The EAGLE's point code is shown in the `PCA`, `PCI`, `PCN`, or `PCN24` fields of the `rtrv-sid` command output.

If the `xlat=dpncht` parameter is specified, the `ri=gt` parameters must be specified.

A point code containing all zeros is not a valid point code.

An ANSI point code or ITU international point code containing all zeros is not a valid point code and cannot be entered into the database. An ITU national point code containing all zeros is a valid point code and can be entered into the database.

Either the `type` parameter or the `ttn` parameter must be specified.

If the `type` parameter is specified, the translation type must be in the database. This can be verified with the `rtrv-tt` command.

If the `type` parameter is not specified, the translation type name must be assigned to a translation type in the database. This can be verified with the `rtrv-tt` command.

The end global title address (`egta`) must be greater than or equal to the start global title address (`gta`) and its length must be equal to the start global title address.

If the range as specified by the `gta` and `egta` parameters does not exactly match the existing range, the existing range is split. All addresses in the existing range that are outside the range specified by `gta` and `egta`, retain the original `xlat`, `ri`, `pc`, and `ssn` parameters. A new range is created and bounded by the `gta` and `egta` containing new values of `xlat`, `ri`, `pc`, and `ssn` as present in the command, and retaining parameter values from the previous range that do not have corresponding new values in the command.

However, if the ranges overlap, splitting cannot occur and the command is rejected. However, if the ranges overlap, splitting cannot occur, and the `chg-gtt` command is rejected with this message.

```
E2401 Cmd Rej:GTA range overlaps a current range
```

Along with error message 2401, a list of the overlapped global title addresses is displayed as shown in the following example.

```
rlghncxa03w 07-02-24 08:29:15 GMT EAGLE5 37.0.0
```

The following GTA ranges overlap the input GTA range

START GTA	END GTA
8005550000	8005551999
8005552000	8005553999
8005554000	8005555999

```
CHG-GTT: MASP A - Command Aborted
```

If the translation type is ANSI (`type` or `typea`), the `pc` type must be ANSI (`pc` or `pca`). If the translation type is one of the ITU types (`typei`, `typen`, or `typen24`) the `pc` type may be either of the ITU types (`pci`, `pcn`, or `pcn24`). If the ANSI/ITU SCCP Conversion feature is enabled, the domain (ANSI or ITU) of the translation type and point code do not have to be the same.

The values specified for the `gta` and `egta` parameters can be decimal digits (0-9) or hexadecimal digits (0-9, a-f, A-F). Hexadecimal digits can be specified only if the Hex Digit Support for GTT feature is enabled. Verify the status of the Hex Digit Support for GTT feature with the `rtrv-ctrl-feat` command. Refer to the [Hex Digit Support](#)

for [GTT](#) section for more information on this feature. If the Hex Digit Support for GTT feature is not enabled, perform the [Activating the Hex Digit Support for GTT Feature](#) procedure to enable the Hex Digit Support for GTT feature.

[Table 3-10](#) shows the valid combinations for the `xlat`, `ri`, and `ssn` parameters. All other combinations are rejected.

Table 3-10 Valid Parameter Combinations for the `chg-gtt` Routing Parameters

New or Existing XLAT Value	New or Existing RI Value	Routing Action	SSN Value
DPC	GT	Translate DPC only and route on GT	Cannot be specified. The current database entry is removed.
DPC	SSN	Translate DPC only and route on SSN	Cannot be specified. The current database entry is removed.
DPCSSN	GT	Translate DPC and SSN and route on GT	Must be specified.
DPCSSN	SSN	Translate DPC and SSN and route on SSN	Must be specified.
DPCNGT	GT	Translate DPC, new translation type (TT), and route on GT	Cannot be specified. The current database entry is removed.

Canceling the `RTRV-GTT` Command

Because the `rtrv-gtt` command used in this procedure can output information for a long period of time, the `rtrv-gtt` command can be canceled and the output to the terminal stopped. There are three ways that the `rtrv-gtt` command can be canceled.

- Press the `F9` function key on the keyboard at the terminal where the `rtrv-gtt` command was entered.
- Enter the `canc-cmd` without the `trm` parameter at the terminal where the `rtrv-gtt` command was entered.
- Enter the `canc-cmd:trm=<xx>`, where `<xx>` is the terminal where the `rtrv-gtt` command was entered, from another terminal other than the terminal where the `rtrv-gtt` command was entered. To enter the `canc-cmd:trm=<xx>` command, the terminal must allow Security Administration commands to be entered from it and the user must be allowed to enter Security Administration commands. The terminal's permissions can be verified with the `rtrv-secu-trm` command. The user's permissions can be verified with the `rtrv-user` or `rtrv-secu-user` commands.

For more information about the `canc-cmd` command, go to *Commands User's Guide*.

1. Display the translation types in the database using the `rtrv-tt` command. This is an example of the possible output.

```
rlghncxa03w 10-07-25 09:42:31 GMT EAGLE5 42.0.0
TYPEA      TTN      NDGT
1          lidb      5
2          c800     10
```

```

3          d700          6
5          scp1          6
10         scp2          6
15         scp3          3

ALIAS     TYPEA
30        5
40        10
50        3
65        3

TYPEI     TTN          NDGT
105      itudb         8

ALIAS     TYPEI
7         105

TYPEN     TTN          NDGT
120      dbitu         7

ALIAS     TYPEN
8         120

TYPEIS    TTN          NDGT

ALIAS     TYPEIS

TYPENS    TTN          NDGT

ALIAS     TYPENS

```

2. Verify that the EGTT feature is on, by entering the `rtrv-feat` command. If the GTT feature is on, the `EGTT` field should be set to `on`.

 **Note:**

The `rtrv-feat` command output contains other fields that are not used by this procedure. If you wish to see all the fields displayed by the `rtrv-feat` command, refer to the `rtrv-feat` command description in *Commands User's Guide*.

If the EGTT feature is off, continue the procedure with [5](#).

If the EGTT feature is on, continue the procedure with [3](#).

3. Display the features that are enabled by entering the `rtrv-ctrl-feat` command.

The following is an example of the possible output.

```
rlghncxa03w 10-07-28 21:15:37 GMT EAGLE5 42.0.0
```

The following features have been permanently enabled:

```
Feature Name          Partnum    Status    Quantity
```

```
Command Class Management 893005801 on ----
LNP Short Message Service 893006601 on ----
Intermed GTT Load Sharing 893006901 on ----
HC-MIM SLK Capacity      893012707 on 64
```

The following features have been temporarily enabled:

```
Feature Name          Partnum  Status  Quantity  Trial
Period Left
Zero entries found.
```

The following features have expired temporary keys:

```
Feature Name          Partnum
Zero entries found.
```

4. Display the GTT selectors in the database by entering the `rtrv-gtttsel` command with the TTN value associated with the translation type that will be assigned to the global title translation. The TTN value is shown in the `rtrv-tt` output in 1.

To specify of the TTN value, the parameters shown in Table 3-11 must be specified with the `rtrv-gtttsel` command. The parameters that can be specified are dependent on the features that are enabled, shown in 3.

Table 3-11 RTRV-GTTSEL Parameters

Feature that is Enabled	Parameter that must be Specified for the TTN Value
Neither the Origin Based SCCP Routing nor the Flexible Linkset Optional Based Routing, shown as Flex Lset Optnl Based Rtg in the <code>rtrv-ctrl-feat</code> output, is enabled.	<code>gttsn</code>
Origin Based SCCP Routing	<code>cdgtasn,cggtasn</code>
Flexible Linkset Optional Based Routing	<code>cdgttsn,cggttsn</code>

For this example, enter this command.

```
rtrv-gtttsel:gttsn=scp3
```

```
rlghncxa03w 10-07-28 21:15:37 GMT EAGLE5 42.0.0
```

```
GTIA  TT  NP  NAI  SELID  GTTSN
  2   15  --  ---  none   scp3
GTII  TT  NP  NAI  SELID  GTTSN

GTIN  TT  NP  NAI  SELID  GTTSN

GTIN24 TT  NP  NAI  SELID  GTTSN

GTIIS  TT  NP  NAI  SELID  GTTSN

GTINS  TT  NP  NAI  SELID  GTTSN
```

If any of the entries shown in the `rtrv-gttset` output do not have the default values for the advanced GTT parameters, or if a GTT selector entry with the TTN value was removed with the `dlt-gttset` command, the remainder of this procedure cannot be performed. Choose another GTT entry to change and repeat this step. The GTT entry should contain another translation type and TTN value.

If all of the entries shown in the `rtrv-gttset` output have the default values for the advanced GTT parameters, and none of the GTT selector entries with the TTN value were removed with the `dlt-gttset` command, continue the procedure with 5.

5. Display the global title translations in the database using the `rtrv-gtt` command specifying a translation type, translation type name, or both from the `rtrv-tt` command output shown in 1.

For this example, enter this command.

```
rtrv-gtt:typea=15
```

This is an example of the possible output.

```
rlghncxa03w 10-07-25 09:43:31 GMT EAGLE5 42.0.0
TYPEA TTN NDGT
15 scp3 3

GTT TABLE IS (27000 of 269999) 10 % FULL

START GTA END GTA XLAT RI PC
800 900 DPC SSN
001-001-001
SSN=--- GTMODID=-----
919 919 DPCSSN SSN
002-002-002
SSN=50 GTMODID=-----
```

Command Retrieved 2 Entries

Continue the procedure with 7 if either of these conditions are present.

- The GTT entry does not contain a range of global title addresses.
- The GTT entry does contain a range of global title addresses and the range of global title addresses is not being split.

The GTT entry does contain a range of global title addresses and the range of global title addresses is being split, continue the procedure with 6 if these conditions are present.

- The number of global title addresses when the range of global title translations is split will not exceed the maximum number of global title translations.
- The number of global title addresses when the range of global title translations is split will exceed the maximum number of global title translations and the maximum number of global title translations is less than 1,000,000. Perform the [Enabling the XGTT Table Expansion Feature](#) procedure to increase the maximum number of global title translations. After the [Enabling the XGTT Table Expansion Feature](#) procedure has been performed, continue the procedure with 6.

The number of global title addresses when the range of global title translations is split will exceed the maximum number of global title translations and the maximum number of global title translations is 1,000,000; the range of global title addresses cannot be split. Continue the procedure with 7.

6. Display the GTT path entries by entering the `rtrv-gttapath` command with these parameters.

`cdgttsn` - the TTN value shown in the `rtrv-gtt` output in 5.

`cdgta` - the START GTA value shown in the `rtrv-gtt` output in 5.

For this example, enter this command.

```
rtrv-gttapath:cdgttsn=scp3:cdgta=800
```

This is an example of the possible output.

```
rlghncxa03w 10-07-25 09:43:31 GMT EAGLE5 42.0.0
```

GTPN	OPGTTSN	CGGTTSN	CDGTTSN

path1	-----	-----	scp3
CDGTA = 800			ECDGTA = 900

GTT-PATH table is (5 of 10000) 1% full.

The range of global title addresses cannot be split if entries containing the TTN and the GTA values shown in the `rtrv-gttapath` output. If entries are displayed in the `rtrv-gttapath` output, perform the [Removing a GTT Action Path Entry](#) procedure to remove the entries shown in the `rtrv-gttapath` output.

Continue the procedure with 7 if no entries are shown in this step; if the entries in the `rtrv-gttapath` output will not be removed; or the [Removing a GTT Action Path Entry](#) procedure has been performed.

7. Continue the procedure by performing one of these steps.

Continue the procedure with 10 if any of these actions will occur.

- The `gtmodid` and `cggtmod=yes` parameters will not be specified in this procedure.
- The `gtmodid=none` parameter will be specified in this procedure and the `cggtmod=yes` parameter will not be specified in this procedure.
- If only the `cggtmod=yes` parameter will be specified in this procedure and entries are shown in the `rtrv-gtt` output (in 5) that contain the `cggtmod=yes` parameter value.

If only the `cggtmod=yes` parameter will be specified in this procedure and no entries are shown in the `rtrv-gtt` output (in 5) that contain the `cggtmod=yes` parameter value, continue the procedure with 9.

If the `gtmodid` parameter with a value other than `none` will be specified in this procedure, continue the procedure with 8.

8. Display the GT modification entries by entering the `rtrv-gtmod` command. This is an example of the possible output.

```
rlghncxa03w 10-07-25 09:43:31 GMT EAGLE5 42.0.0

GTMODID  NTT  NGTI  GT0FILL  NNP  NNAI  NPDD  NSDD  PRECD  CGPASSN
modid2   --   2     ON    --   --   --   --   PFX    --
      NPDS=
modid5   --   2     OFF   --   --   --   --   PFX    --
      NPDS=
modid10  --   --   OFF   5     5   --   --   PFX    --
      NPDS=
modid11  --   --   OFF   5     5   --   --   PFX    --
      NPDS=
modid20  --   2     ON    --   --   --   --   PFX    --
      NPDS=
modid7   --   2     OFF   --   --   4     4   PFX    --
      NPDS=2345                      NSDS=12ae
```

GTMOD table is (6 of 100000) 1% full.

If the NGTI value of the GT modification entry that will be assigned to the GTT entry is 4, the GTT entry must contain an ITU point code.

If the GT modification entry that you wish to assign to the GTT entry is not shown in the `rtrv-gtmod` output, perform the [Adding Global Title Modification Information](#) procedure to add the desired GT modification entry.

 **Note:**

Either the AMGTT or AMGTT CgPA Upgrade features must be enabled to specify the `cggmod=yes` parameter for the GTT entry.

If the GT modification entry that you wish to assign to the GTT entry is shown in the `rtrv-gtmod` output or the [Adding Global Title Modification Information](#) procedure was performed, continue the procedure by performing one of these steps.

- Continue the procedure with [10](#) if any of these actions will occur.
 - The `cggmod=yes` parameter will not be specified in this procedure.
 - The `cggmod=yes` parameter will be specified in this procedure and entries are shown in the `rtrv-gtt` output (in [5](#)) that contain the `cggmod=yes` parameter value.
 - The `cggmod=yes` parameter will be specified in this procedure and no entries are shown in the `rtrv-gtt` output (in [5](#)) that contain the `cggmod=yes` parameter value. Continue the procedure with [9](#).
9. To specify only `cggmod=yes` parameter in this procedure, one of these the Advanced GT Modification features must be enabled.
- AMGTT - 893021801

- AMGTT CgPA Upgrade - 893021803

Enter the `rtrv-ctrl-feat` command to verify the status of the AMGTT or AMGTT CgPA Upgrade feature.

The following is an example of the possible output.

```
rlghncxa03w 10-07-28 21:15:37 GMT EAGLE5 42.0.0
The following features have been permanently enabled:
```

Feature Name	Partnum	Status	Quantity
IPGWx Signaling TPS	893012814	on	20000
ISUP Normalization	893000201	on	----
Command Class Management	893005801	on	----
LNP Short Message Service	893006601	on	----
Intermed GTT Load Sharing	893006901	on	----
HC-MIM SLK Capacity	893012707	on	64

The following features have been temporarily enabled:

Feature Name	Partnum	Status	Quantity	Trial Period Left
Zero entries found.				

The following features have expired temporary keys:

Feature Name	Partnum
Zero entries found.	

If none of the required Advanced GT Modification features are shown in the `rtrv-ctrl-feat` output in this step (AMGTT, AMGTT CgPA Upgrade), perform the [Activating the Advanced GT Modification Feature](#) procedure to enable the AMGTT feature. After the AMGTT feature has been enabled, continue the procedure with [10](#).

If either the AMGTT or AMGTT CgPA Upgrade features are shown in the `rtrv-ctrl-feat` output in this step, continue the procedure with [10](#).

10. If the domain (ANSI or ITU) of the point code and the translation type assigned to the global title translation type will be different, and the `ngti` parameter will be specified with the global title translation, the ANSI/ITU SCCP Conversion feature (SCCP Conversion) must be enabled. If the ANSI/ITU SCCP Conversion feature is not being used, continue the procedure with [11](#).

Verify that the ANSI/ITU SCCP Conversion feature is enabled by entering the `rtrv-ctrl-feat:partnum=893012001` command.

The following is an example of the possible output.

```
rlghncxa03w 07-02-28 21:15:37 GMT EAGLE5 37.0.0
The following features have been permanently enabled:
```

Feature Name	Partnum	Status	Quantity
SCCP Conversion	893012001	on	----

The following features have been temporarily enabled:

```
Feature Name          Partnum   Status   Quantity   Trial Period
Left
Zero entries found.
```

The following features have expired temporary keys:

```
Feature Name          Partnum
Zero entries found.
```

If the ANSI/ITU SCCP Conversion feature is not enabled, perform the [Activating the ANSI/ITU SCCP Conversion Feature](#) procedure to enable the ANSI/ITU SCCP Conversion feature.

11. Hexadecimal digits (0-9, a-f, A-F) can be specified as values for the `gta` or `egta` parameters only if the Hex Digit Support for GTT feature is enabled. Verify the status of the Hex Digit Support for GTT feature by entering the `rtrv-ctrl-feat` command with the Hex Digit Support for GTT feature part number.

Enter this command.

```
rtrv-ctrl-feat:partnum=893018501
The following is an example of the possible output.
```

```
rlghncxa03w 07-05-28 21:15:37 GMT EAGLE5 37.0.0
```

The following features have been permanently enabled:

```
Feature Name          Partnum   Status   Quantity
Hex Digit Support for GTT 893018501  on      ----
```

The following features have been temporarily enabled:

```
Feature Name          Partnum   Status   Quantity   Trial Period Left
Zero entries found.
```

The following features have expired temporary keys:

```
Feature Name Partnum
Zero entries found.
```

If the Hex Digit Support for GTT feature has not been enabled, perform the [Activating the Hex Digit Support for GTT Feature](#) procedure to enable this feature. After the Hex Digit Support for GTT feature is enabled, continue the procedure by performing one of these steps.

If the `LOOPSET` value will be changed, continue the procedure with [12](#).

If the `LOOPSET` value will not be changed, continue the procedure with [14](#).

12. If the `LOOPSET` field appears in the output shown in [5](#), the SCCP Loop Detection feature is enabled, continue the procedure with [13](#).

If the `LOOPSET` field appears in the output shown in [5](#), the SCCP Loop Detection feature is not enabled. Perform the [Activating the SCCP Loop Detection Feature](#) procedure to enable the SCCP Loop Detection feature. After the SCCP Loop Detection Feature has been enabled, perform the [Adding a Loopset](#) procedure to add the required loopset. After the loopset has been added, continue the procedure with [14](#).

13. Display all the loopsets in the database by entering this command.

rtrv-loopset:num=1000:force=yes
This is an example of the possible output.

LoopSet	Mode	Point Codes	
=====			
==			
cary2	notify	005-015-005 033-004-003 005-027-005	007-007-007 033-007-003 007-004-007 (ANSI)
cary4	notify	005-012-005 003-049-003 005-008-055	007-026-007 033-002-003 007-014-007 (ANSI)
apex3	discard	005-017-008 033-005-043 005-017-005 033-002-043 007-009-027 005-012-005	007-017-009 005-014-005 007-014-007 005-038-005 033-003-043 007-002-027 (ANSI)
apex4	discard	005-007-008 033-005-003 027-001-007 033-007-003 027-008-007	027-007-009 005-004-055 033-008-003 005-003-055 (ANSI)
ral5	notify	005-005-005 003-004-003 005-007-005 003-002-003 007-009-007 005-002-005	007-007-007 003-001-003 007-004-007 005-008-005 003-003-003 007-002-007 (ANSI)
ral6	notify	005-007-008 003-005-003 005-007-005	007-007-009 003-007-003 (ANSI)
dunn1	discard	005-002-055 003-008-033	007-051-007 (ANSI)
rtp9	discard	005-002-005 003-008-003 005-003-005 005-004-005	007-001-007 003-007-003 007-008-007 (ANSI)
rtp5	discard	005-007-008 003-005-003	007-007-009 (ANSI)
rtp1	discard	005-005-005 003-004-003 005-007-005 005-004-005	007-007-007 003-007-003 007-004-007 (ANSI)
rtp2	notify	005-007-008	007-007-009 (ANSI)

003-005-003

```
rlghncxa03w 07-03-07 08:50:15 GMT Rel 37.0.0
LOOPSET table is (11 of 1000) 1% full
RTRV-LOOPSET: MASP A - COMPLTD
```

 **Note:**

If the `rtrv-loopset` command is entered with no other parameters specified, a maximum of 50 entries are displayed. To display more than 50 entries, the `force=yes` parameter must be specified with the `rtrv-loopset` command and the `num` parameter value must be greater than 50. Since there can be a maximum of 1000 loopsets in the database, to display all the loopsets in the database, the `force=yes` and `num=1000` parameters must be specified with the `rtrv-loopset` command.

If the required loopset is shown in the `rtrv-loopset` output, continue the procedure with [14](#).

If the required loopset is not shown in the `rtrv-loopset` output, perform the [Adding a Loopset](#) procedure to add the required loopset. After the loopset has been added, continue the procedure with [14](#).

14. Continue the procedure by performing one of these steps.

- If the routing indicator value will be `SSN` when this procedure is finished, continue the procedure by performing one of these steps.
 - If the `xlat` parameter value will be `dpc` when this procedure is completed, continue the procedure by performing one of these steps.
 - * If the point code value will not be changed and the Flexible GTT Load Sharing feature is not enabled (the `MAPSET` field is not shown in `rtrv-gtt`), continue the procedure with [22](#).
 - * If the point code value will not be changed; the Flexible GTT Load Sharing feature is enabled and the `MAPSET` value will not be changed, continue the procedure with [22](#).
 - * If the point code value will not be changed; the Flexible GTT Load Sharing feature is enabled and the `MAPSET` value will be changed, continue the procedure with [20](#).
 - * If the point code value will be changed, continue the procedure with [20](#).
 - If the `xlat` parameter value will be `dpcssn` when this procedure is completed, continue the procedure by performing one of these steps.
 - * If the point code, `SSN`, and `MAPSET` value (if the Flexible GTT Load Sharing feature is enabled, the `MAPSET` field is shown in `rtrv-gtt`) will not be changed, continue the procedure with [22](#).
 - * If the point code will be changed, continue the procedure by performing one of these steps.

- * If the new point code value will not be the EAGLE's point code, continue the procedure with [20](#).
 - * If the new point code value will be the EAGLE's point code, continue the procedure with [19](#).
 - * If only the SSN value will be changed, continue the procedure with [19](#).
 - * If the Flexible GTT Load Sharing feature is enabled and only the MAPSET value will be changed, continue the procedure with [19](#).
- If the routing indicator value will be GT when this procedure is finished, continue the procedure by performing one of these steps.
- * If the Flexible GTT Load Sharing feature is not enabled; the MRNSET value will not be specified and the point code value will not be changed, continue the procedure with [22](#).
 - * If the Flexible GTT Load Sharing feature is not enabled but the point code value will be changed, continue the procedure with [16](#).
 - * If the Flexible GTT Load Sharing feature is enabled and the point code will be changed, whether or not the MRNSET value will be changed, continue the procedure with [15](#).
 - * If the Flexible GTT Load Sharing feature is not enabled; the point code will not be changed, but the mrnset parameter will be specified, perform the [Activating the Flexible GTT Load Sharing Feature](#) procedure followed by the [Provisioning MRN Entries](#) procedure. When this is completed, continue the procedure with [22](#).
- 15.** The point code and MRN set ID specified for the global title translation must be shown in the `rtrv-mrn` command output. The point code must be assigned to the MRN set that will be assigned to the global title translation.

Enter the `rtrv-mrn` command to verify that the required MRN set is configured in the database, and that the required point code is assigned to the MRN set. The following is an example of the possible output.

```
r1ghncxa03w 07-02-28 21:15:37 GMT EAGLE5 37.0.0
```

```
MRNSET  PC          RC
DFLT    001-001-001    10
         001-001-002    20
         001-001-003    30
```

```
MRNSET  PC          RC
110     001-001-001    10
         001-001-005    20
         001-001-006    30
         001-001-003    40
         001-001-008    50
```

```
MRNSET  PC          RC
111     001-001-001    30
         001-001-005    30
         001-001-006    30
         001-001-003    30
```



```

001-001-008 30

MRNSET PC RC
112 001-003-001 10
001-003-002 10
001-003-003 30
001-003-004 30
001-003-006 60
001-003-007 60
001-003-008 80
001-003-009 80

MRNSET PCN RC
113 s-1-1-1-0123-aa 1
s-1-1-1-0235-aa 2
s-1-1-1-0235-aa 3

```

 **Note:**

If the Weighted GTT Load Sharing feature is enabled, the WT, %WT, and THR columns are shown in the `rtrv-mrn` output

If the required MRN set is not shown in the `rtrv-mrn` output, or if the required point code is not assigned to the required MRN set, provision the required MRN set by performing the [Provisioning MRN Entries](#) procedure. After provisioning the required MRN set, continue the procedure with [22](#). If the required MRN set is shown in the `rtrv-mrn` output, or if the required point code is assigned to the required MRN set, continue the procedure with [22](#).

16. Display the destination point codes in the database by entering the `rtrv-dstn` command. This is an example of the possible output.

```

rlghncxa03w 10-12-10 11:43:04 GMT EAGLE5 43.0.0
Extended Processing Time may be Required

```

```

DPCA          CLLI          BEI ELEI  ALIASI
ALIASN/N24    DMN
001-207-000  ----- no  --- -----
-----      SS7
001-001-001  ----- no  --- -----
-----      SS7
001-001-002  ----- no  --- -----
-----      SS7
001-005-000  ----- no  --- -----
-----      SS7
001-007-000  ----- no  --- -----
-----      SS7
008-012-003  ----- no  --- -----
-----      SS7
003-002-004  ----- no  --- -----
-----      SS7
009-002-003  ----- no  --- -----
-----      SS7

```

```

010-020-005 ----- no --- -----
----- SS7

DPCI          CLLI          BEI ELEI  ALIASA
ALIASN/N24    DMN
1-207-0      ----- no --- -----
----- SS7
0-015-0      ----- no --- -----
----- SS7
0-017-0      ----- no --- -----
----- SS7
1-011-1      ----- no --- -----
----- SS7
1-011-2      ----- no --- -----
----- SS7

```

Destination table is (14 of 2000) 1% full
Alias table is (0 of 12000) 0% full
PPC table is (1 of 20) 5% full

If the required point code is not shown in the `rtrv-dstn` output, perform the "Adding a Destination Point Code" procedure in *Database Administration - SS7 User's Guide* to add the required point code. A proxy point code cannot be assigned to the point code.

After the new point code has been added, and perform one of the Adding a Route procedures in *Database Administration - SS7 User's Guide* and add the required route to the database. After the route has been added, continue the procedure with [22](#).

If the required point code is shown in the `rtrv-dstn` output, continue the procedure with [17](#)

17. Display the point code that will be assigned to the global title translation by using the `rtrv-dstn` command and specifying the point code. For this example, enter this command.

```
rtrv-dstn:dPCA=010-020-005
```

This is an example of the possible output.

```
rlghncxa03w 10-12-10 11:43:04 GMT EAGLE5 43.0.0
```

```

DPCA          CLLI          BEI ELEI  ALIASI
ALIASN/N24    DMN
010-020-005  ----- no --- -----
----- SS7

PPCA          NCAI PRX      RCAUSE NPRST SPLITIAM HMSMSC HMSCP
SCCPMSGCNV
009-002-003  ---- no      50      on      20      no      no      none

```

Destination table is (14 of 2000) 1% full
Alias table is (0 of 12000) 0% full
PPC table is (1 of 20) 5% full

A proxy point code (a point code value is shown in the PPC column) cannot be assigned to the point code. If a proxy point code is shown in this step, choose another point code from the `rtrv-dstn` output in the previous step and repeat this step.

If a proxy point code is not shown in this step, continue the procedure with 18.

18. The point code specified with the `chg-gtt` command must be the DPC of a route, unless the point code is the EAGLE's point code.

Enter the `rtrv-rte` command with the `dpc` parameter specifying the point code to be used with the `chg-gtt` command to verify whether or not the point code is the DPC of a route. For this example, enter these commands.

```
rtrv-rte:dPCA=003-003-003
```

This is an example of the possible output.

```
rlghncxa03w 07-02-07 11:43:04 GMT EAGLE5 37.0.0
DPCA          ALIASI          ALIASN/N24      LSN            RC            APCA
002-002-003   -----          -----          ls05           10            002-002-003
                                     ls15           30            089-047-123
                                     lsa8           50            077-056-000
                                           RTX:No        CLLI=ls05clli
```

```
rtrv-rte:dPCA=002-002-003
```

This is an example of the possible output.

```
rlghncxa03w 07-05-07 11:43:04 GMT EAGLE5 37.0.0
DPCA          ALIASI          ALIASN/N24      LSN            RC            APCA
003-003-003   -----          -----          ls07           10            003-003-003
                                     ls08           30            025-025-150
                                     lsa5           50            066-030-100
                                           RTX:No        CLLI=ls07clli
```

If the point code is not shown in the `rtrv-rte` output, perform one of the procedures in *Database Administration - SS7 User's Guide* and add the required route to the database.

If the point code is shown in the `rtrv-rte` output or if the required route was added, continue the procedure with 22.

19. If the `ri=ssn` and `xlat=dpcssn` parameters are specified with the `chg-gtt` command, and you wish to use the EAGLE's point code for the value of the `pc` parameter of the `chg-gtt` command, the point code value must be in the EAGLE's self ID table.

Display the EAGLE self-identification, using the `rtrv-sid` command. This is an example of the possible output.

```
rlghncxa03w 07-02-10 11:43:04 GMT EAGLE5 37.0.0
  PCA          PCI          PCN          CLLI
PCTYPE
  010-020-030  1-023-1      12-0-14-1    rlghncxa03w
OTHER
                s-1-023-1    s-12-0-14-1
CPCA
```

002-002-002	002-002-003	002-002-004	002-002-005
002-002-006	002-002-007	002-002-008	002-002-009
004-002-001	004-003-003	050-060-070	
CPCI			
1-001-1	1-001-2	1-001-3	1-001-4
1-002-1	1-002-2	1-002-3	1-002-4
2-001-1	7-222-7		
CPCN			
2-0-10-3	2-0-11-0	2-0-11-2	2-0-12-1
2-2-3-3	2-2-4-0	10-14-10-1	

Continue the procedure with [22](#) if either of these actions will be performed.

- The current point code of the GTT entry is shown in this step and the point code and SSN values of the GTT entry are not being changed, and the GTT entry contains a MAPSET value, the point code and SSN values of the GTT entry must be in the default MAP set. The MAPSET value in the GTT entry cannot be changed.
- The current point code of the GTT entry is not shown in this step; the point code of the GTT entry is not being changed, but the SSN value of the GTT entry is being change and the GTT entry does not contain a MAPSET value.
- The current point code of the GTT entry is not shown in this step and the GTT entry contains a MAPSET value and the MAPSET value of the GTT entry will not be changed.

Continue the procedure with [20](#) if either of these actions will be performed.

- The new point code value of the GTT entry is shown in this step.
- The current point code value of the GTT entry is shown in this step and is not being changed, but the SSN value of the GTT entry is being changed.
- The point code value of the GTT entry is not shown in this step; the SSN value of the GTT entry will be changed, and the GTT entry contains a MAPSET value.
- The point code value of the GTT entry is not shown in this step; the point code and SSN values of the GTT entry are not being changed; the GTT entry contains a MAPSET value and the MAPSET value will be changed.

- 20.** Enter the `rtrv-map` command with the `pc` parameter specifying the required point code to verify that the required data is in the mated application table.

The `ssn` parameter with the new SSN value must be specified with the `rtrv-map` command if these conditions are present.

- The point code value of the GTT entry is not shown in [19](#); the point code and SSN values of the GTT entry are not being changed; the GTT entry contains a MAPSET value and the MAPSET value will be changed.
- The current point code value of the GTT entry is shown in [19](#) and is not being changed, but the SSN value of the GTT entry is being changed whether of not the GTT entry contains a MAPSET value.

For this example enter this command.

```
rtrv-map:pc=002-002-003
```

If the Flexible GTT Load Sharing feature is not enabled, this is an example of the possible output.

```
rlghncxa03w 09-07-25 09:42:31 GMT EAGLE5 41.1.0

PCA          Mate PCA          SSN RC MULT SRM MRC GRP NAME SSO
002-002-003          250 10 SOL *Y *Y GRP01     ON
```

MAP table is (37 of 1024) 4% full.

If the Flexible GTT Load Sharing feature is enabled, this is an example of the possible output.

```
rlghncxa03w 09-07-25 09:42:31 GMT EAGLE5 41.1.0

MAPSET ID=DFLT
PCA          Mate PCA          SSN RC MULT SRM MRC GRP NAME SSO
002-002-003          55  5  DOM YES YES ----- OFF
                   001-001-002  15 15  DOM YES YES ----- ON
                   001-001-003  25 20  DOM YES YES ----- ON
                   001-001-002  40 35  DOM YES YES ----- OFF

MAPSET ID=1
PCA          Mate PCA          SSN RC MULT SRM MRC GRP NAME SSO
002-002-003          254  5  DOM YES YES ----- OFF
                   001-001-002  10 15  DOM YES YES ----- ON
                   001-001-003  20 20  DOM YES YES ----- ON
                   001-001-002  40 35  DOM YES YES ----- OFF

MAPSET ID= 2
PCA          Mate PCA          SSN RC MULT SRM MRC GRP NAME SSO
002-002-003          5 10  SOL *Y *Y ----- OFF
```

MAP table is (12 of 36000) 1% full.

 **Note:**

If the Weighted GTT Load Sharing feature is enabled, the WT, %WT, and THR columns are shown in the `rtrv-map` output.

If the parameter values for the `ri` and `xlat` parameters will be `ri=ssn` and `xlat=dpc` when this procedure is completed, the point code value must be in the mated application table. If the point code value is not in the mated application table when the `chg-gtt` command is executed, the `force=yes` parameter must be specified with the `chg-gtt` command. However, the point code value of the GTT entry must be the DPC of a route. If the GTT entry has a MAPSET value and the MAPSET value is being changed, but the point code value of the GTT entry is not being changed, the new MAP set must contain the current point code value of the GTT entry.

- Continue the procedure with [16](#) if either of these actions will be performed.

- The point code value of the GTT entry is being changed and the new point code value is not shown in the `rtrv-map` output.
- The `rtrv-map` output does not contain another MAP set with the current point code value.
- Continue the procedure with [22](#) if either of these actions will be performed.
 - The point code value of the GTT entry is being changed and the new point code value is shown in the `rtrv-map` output.
 - The `rtrv-map` output does contain another MAP set with the current point code value.

If the parameter values for the `ri` and `xlat` parameters will be `ri=ssn` and `xlat=dpcssn`, the point code, subsystem number, and MAPSET values (if the Flexible GTT Load Sharing feature is enabled) that will be in the GTT entry when this procedure is finished must be shown in the `rtrv-map` output in this step.

If the required point code, subsystem number, or MAPSET values are not shown in the `rtrv-map` output, perform one of these procedures to add the required information to the mated application table.

- [Provisioning a Solitary Mated Application](#)
- [Provisioning a Dominant Mated Application](#)
- [Provisioning a Load Shared Mated Application](#)
- [Provisioning a Combined Dominant/Load Shared Mated Application](#)

If the point code value of the GTT entry when this procedure is finished will not be the EAGLE's point code, continue the procedure with [22](#).

If the point code value of the GTT entry when this procedure is finished will be the EAGLE's point code, continue the procedure with [21](#).

21. Enter the `rtrv-ss-appl` command to verify that either the LNP, EIR, INP, V-Flex, ATINPQ, or AIQ subsystem number (depending on which feature is on) is the subsystem application table.

This is an example of the possible output.

```
rlghncxa03w 08-09-28 14:42:38 GMT EAGLE5 39.2.0
APPL      SSN      STAT
LNP       254      ONLINE
```

```
SS-APPL table is 20% FULL (1 of 5)
```

If the subsystem number is shown in the `rtrv-ss-appl` output, continue the procedure with [22](#).

If no subsystem number is shown in the `rtrv-ss-appl` output, or if the `rtrv-ss-appl` command is rejected, go to one of these user's guides, depending on the type of subsystem you wish to use, and enable the feature if necessary, and add the subsystem to the subsystem application table.

- EIR subsystem – go to *EIR User's Guide*.
- INP subsystem – go to *INP/AINPQ User's Guide*.
- LNP subsystem – go to *ELAP Administration and LNP Feature Activation Guide*.

- V-Flex subsystem – go to *V-Flex User's Guide*.
- ATINPQ subsystem – go to *ATINP User's Guide*.
- AIQ subsystem – go to *Analyzed Information Features User's Guide*.

 **Note:**

If the Flexible GTT Load Sharing feature is enabled, a MAP set ID must be specified for the final global title translation. The point code and SSN specified for the final global title translation being changed in this procedure must be assigned to the MAP set ID that will be assigned to the final global title translation. Perform 20 to verify that the required MAP set is configured in the database.

 **Note:**

If the Flexible GTT Load Sharing feature is not enabled, and the `ri` parameter value will be `ssn`, the `xlat` parameter value will be `dpcssn`, the point code value will not be the EAGLE's point code, and the SSN parameter value will not be the EAGLE's subsystem number when this procedure is completed, continue the procedure with 22.

22. Change the global title translation using the `chg-gtt` command using the parameter combinations shown in Table 3-12.

For this example, enter this command.

```
chg-
gtt:type=15:gta=800:egta=850:xlat=dpcssn:ri=gt:pc=003-003-003
:ssn=254 :mrnset=114
```

```
chg-
gtt:type=15:gta=919:xlat=dpcssn:ri=ssn:pc=002-002-003:ssn=254
:mapset=1 :loopset=rtp2
```

This message should appear.

```
rlghncxa03w 07-02-25 09:44:31 GMT EAGLE5 37.0.0
CHG-GTT: MASP A - COMPLTD
```

Table 3-12 Change GTT Parameter Combinations

RI = GT XLAT= DPCNGT	RI = GT XLAT= DPCSSN	RI = GT XLAT= DPC	RI = SSN XLAT= DPCSSN	RI = SSN XLAT= DPC
Mandatory Parameters				

Table 3-12 (Cont.) Change GTT Parameter Combinations

RI = GT XLAT= DPCNGT	RI = GT XLAT= DPCSSN	RI = GT XLAT= DPC	RI = SSN XLAT= DPCSSN	RI = SSN XLAT= DPC
TYPE/TYPERA/ TYPEI/TYPEN	TYPE/TYPERA/ TYPEI/TYPEN	TYPE/TYPERA/ TYPEI/TYPEN	TYPE/TYPERA/ TYPEI/TYPEN	TYPE/TYPERA/ TYPEI/TYPEN
TYPEIS/ TYPENS	TYPEIS/ TYPENS	TYPEIS/ TYPENS	TYPEIS/ TYPENS	TYPEIS/ TYPENS
TYPEN24 (See Notes 2 and 3)	TYPEN24 (See Notes 2 and 3)	TYPEN24 (See Notes 2 and 3)	TYPEN24 (See Notes 2 and 3)	TYPEN24 (See Notes 2 and 3)
GTA (See Notes 10, 12, and 14)	GTA (See Notes 10, 12, and 14)	GTA (See Notes 10, 12, and 14)	GTA (See Notes 10, 12, and 14)	GTA (See Notes 10, 12, and 14)
Optional Parameters (See Notes 19 and 20)				
PC/PCA/PCI/ PCN/PCN24 (See Notes 1, 3, and 6)	PC/PCA/PCI/ PCN/PCN24 (See Notes 1, 3, and 6)	PC/PCA/PCI/ PCN/PCN24 (See Notes 1, 3, and 6)	PC/PCA/PCI/ PCN/PCN24 (See Notes 1, 3, and 6)	PC/PCA/PCI/ PCN/PCN24 (See Notes 1, 3, and 6)
TTN (See Notes 12, 13, and 14)	TTN (See Notes 12, 13, and 14)	TTN (See Notes 12, 13, and 14)	TTN (See Notes 12, 13, and 14)	TTN (See Notes 12, 13, and 14)
EGTA(See Notes 10, 15, and 18)	EGTA (See Notes 10, 15, and 18)	EGTA (See Notes 10, 15, and 18)	EGTA (See Notes 10, 15, and 18)	EGTA (See Notes 10, 15, and 18)
GTMODID (See Note 5)	GTMODID (See Note 5)	GTMODID (See Note 5)	GTMODID (See Note 5)	GTMODID (See Note 5)
>MRNSET (See Notes 7 and 16)	>MRNSET (See Notes 7 and 16)	>MRNSET (See Notes 7 and 16)	>MAPSET (See Notes 7 and 16)	MAPSET (See Notes 7 and 16)
SPLIT (See Note 18)	SPLIT (See Note 18)	SPLIT (See Note 18)	SPLIT (See Note 18)	SPLIT (See Note 18)
>LOOPSET (See Note 11)	>LOOPSET (See Note 11)	>LOOPSET (See Note 11)	>LOOPSET (See Note 11)	LOOPSET (See Note 11)
>CGGTMOD (See Note 4)	>CGGTMOD (See Note 4)	>CGGTMOD (See Note 4)	>CGGTMOD (See Note 4)	CGGTMOD (See Note 4)
	SSN		SSN	FORCE (See Note 8)

Parameter Values:

TYPE/TYPERA/TYPERI/TYPERIS/TYPEN/TYPENS/TYPEN24 – The translation type from the TYPE/TYPERA/TYPERI/TYPERIS/TYPEN/TYPENS/TYPEN24 column of the `rtrv-tt` output – See Note 2

TTN – The translation type name from the **TTN** column of the `rtrv-tt` output.

GTA – 1 - 21 digits or 1 - 21 hexadecimal digits

PC/PCA/PCI/PCN/PCN24 – See Note 1

SSN – 0 - 255

EGTA – 1 - 21 digits or 1 - 21 hexadecimal digits. Default = same as the **GTA** value

FORCE – yes, no. Default = no

LOOPSET – Loopset name from the `rtrv-loopset` output

SPLIT - yes, no. Default = yes

MRNSET – MRN set ID from the `rtrv-mrn` output

MAPSET – MAP set ID from the `rtrv-map` output

CGGTMOD – yes, no. Default = no

GTMODID – GT modification identifier from the `rtrv-gtmod` output

Table 3-12 (Cont.) Change GTT Parameter Combinations

RI = GT XLAT= DPCNGT	RI = GT XLAT= DPCSSN	RI = GT XLAT= DPC	RI = SSN XLAT= DPCSSN	RI = SSN XLAT= DPC
-------------------------------------	-------------------------------------	------------------------------	--------------------------------------	-------------------------------

Notes:

- a. The `pc/pca/pci/pcn/pcn24` parameters are used to assign either ANSI, ITU-I, ITU-I spare, 14-bit ITU-N, 14-bit ITU-N spare, or 24-bit ITU-N point codes to the global title translation (GTT).
 - `pc/pca` = ANSI point code
 - `pci` = ITU-I or ITU-I spare point code
 - `pcn` = 14-bit ITU-N or 14-bit ITU-N spare point code
 - `pcn24` = 24-bit ITU-N point code.
- b. The `type/typea/typei/typen/typeis/typens/typen24` parameters specify the translation type and the network type of the translation type.
 - `type/typea` = ANSI translation type
 - `typei` = ITU-I translation type
 - `typen` = ITU-N translation type
 - `typeis` = ITU-I spare translation type
 - `typens` = ITU-N spare translation type
 - `typen24` = ITU-N24 translation type
- c. The domain (ANSI or ITU) of the point code and translation type must be the same, unless the ANSI/ITU SCCP Conversion feature is enabled. If the ANSI/ITU SCCP Conversion feature is enabled, a GTT may contain an ANSI point code and an ITU translation type, or an ITU point code and an ANSI translation type. Whether the ANSI/ITU SCCP Conversion feature is enabled or not, the translation type parameters `typei`, `typeis`, `typen`, `typens`, or `typen24` can be specified with either the `pci`, `pcn`, or `pcn24` parameters.
- d. The `cggmod=yes` parameter can be specified only if the AMGTT or AMGTT CgPA Upgrade feature is enabled.
- e. A GT modification identifier entry can contain the `ngti=4` parameter value only if the point code value in the GTT entry is an ITU point code.
- f. If the point code is the EAGLE's point code, then the `xlat` parameter value must be `dpcssn` and the `ri` parameter value must be `ssn`.
- g. The `mrnset` parameter can be specified only, and must be specified, if the Flexible GTT Load Sharing feature is enabled.
- h. If the `pc/pca/pci/pcn/pcn24` parameter value is not shown in the `rtrv-map` output, the `force=yes` parameter must be specified with the `ent-gtt` command.
- i. The `mapset` parameter can be specified only, and must be specified, if the Flexible GTT Load Sharing feature is enabled.
- j. Hexadecimal digits (0-9, a-f, A-F) can be specified for the `gta` or `egta` parameters only if the Hex Digit support for GTT feature is enabled.
- k. The `loopset` parameter can be specified only if the SCCP Loop Detection feature is enabled.
- l. Either the `type` parameter or the `ttn` parameter must be specified.
- m. If the `type` parameter is not specified, the translation type name must be assigned to a translation type in the database. This can be verified with the `rtrv-tt` command.

Table 3-12 (Cont.) Change GTT Parameter Combinations

RI = GT XLAT= DPCNGT	RI = GT XLAT= DPCSSN	RI = GT XLAT= DPC	RI = SSN XLAT= DPCSSN	RI = SSN XLAT= DPC
n.	If the <code>type</code> and <code>ttn</code> parameters are specified, the specified translation type must be in the database and the specified translation type name must be assigned to the translation type.			
o.	The end global title address (<code>egta</code>) must be greater than or equal to the start global title address (<code>gta</code>) and its length must be equal to the start global title address.			
p.	Specifying the <code>mrnset=none</code> parameter removes the MRN set ID assignment from the global title translation.			
q.	Specifying the <code>mapset=none</code> parameter removes the MAP set ID assignment from the global title translation.			
r.	The range of global title addresses assigned to a global title translation can be extended, reduced, or split to create a new range of global title addresses. Refer to the split parameter description section in this procedure for information on changing the range of global title addresses.			
s.	Unless a default value is shown in this table, the value of any optional parameter that is not specified in this procedure is not changed.			
t.	At least one optional parameter must be specified.			

- 23.** Verify the changes using the `rtrv-gtt` command specifying the translation type, translation type name, or both used in [22](#). If the `num` parameter is specified with the `rtrv-gtt` command, and the value of the `num` parameter is greater than 1000, the `force=yes` parameter must be specified with the `rtrv-gtt` command.

For this example, enter this command.

```
rtrv-gtt:typea=15:gta=800
```

This is an example of the possible output.

```
rlghncxa03w 10-07-25 09:45:31 GMT EAGLE5 42.0.0
TYPEA TTN NDGT
15 scp3 3

GTT TABLE IS (27000 of 269999) 10 % FULL

START GTA END GTA XLAT RI PC
800 850 DPCSSN GT
003-003-003
MRNSET=114 SSN=254 GTMODID=----- CGGTMOD = NO
LOOPSET = none
```

Command Retrieved 1 Entries

```
rtrv-gtt:typea=15:gta=919
```

This is an example of the possible output.

```
rlghncxa03w 10-07-25 09:43:31 GMT EAGLE5 42.0.0
TYPEA TTN NDGT
```

```
15      scp3      3

GTT TABLE IS      (27000 of 269999)      10 % FULL

START GTA          END GTA          XLAT  RI      PC
919                919                DPCSSN SSN
002-002-003
      MAPSET=1      SSN=254  GTMODID=-----  CGGTMOD = NO
      LOOPSET = rtp2
```

Command Retrieved 1 Entries

- 24.** Backup the new changes using the `chg-db:action=backup:dest=fixed` command. These messages should appear, the active Maintenance and Administration Subsystem Processor (MASP) appears first.

```
BACKUP (FIXED) : MASP A - Backup starts on active MASP.
BACKUP (FIXED) : MASP A - Backup on active MASP to fixed disk
complete.
BACKUP (FIXED) : MASP A - Backup starts on standby MASP.
BACKUP (FIXED) : MASP A - Backup on standby MASP to fixed disk
complete.
```

Figure 3-23 Change a Global Title Translation - Sheet 1 of 14

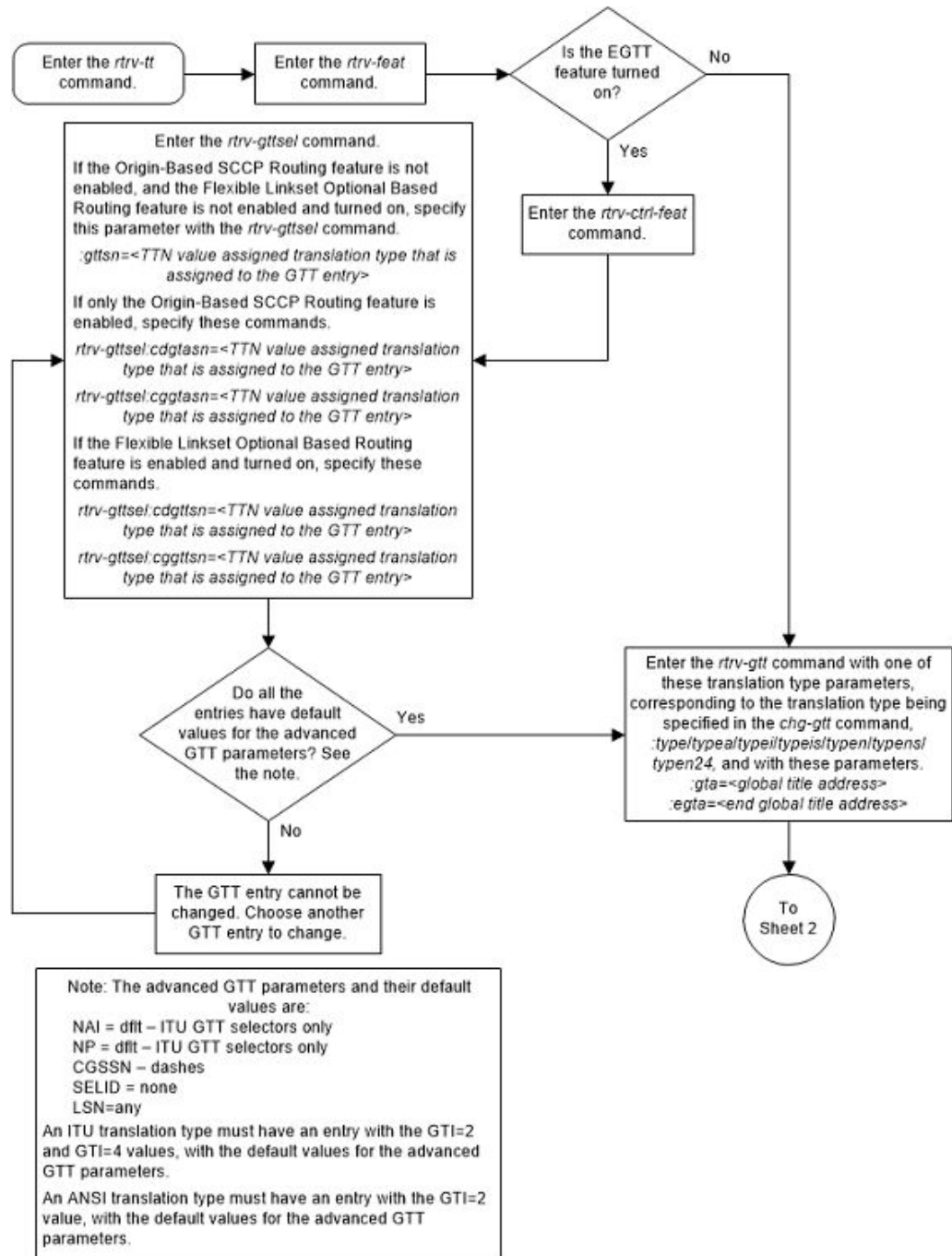

Figure 3-24 Change a Global Title Translation - Sheet 2 of 14

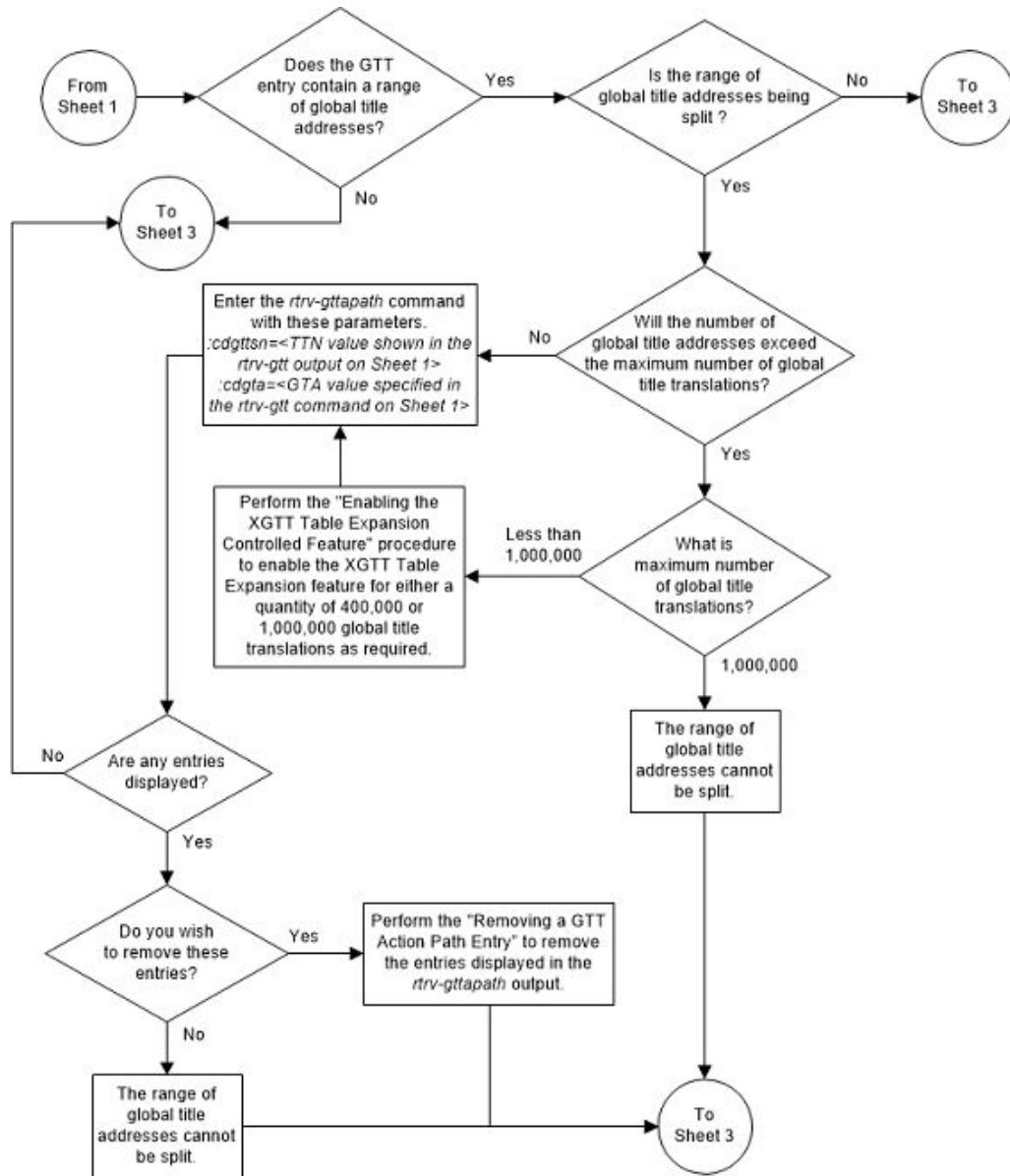

Figure 3-25 Change a Global Title Translation - Sheet 3 of 14

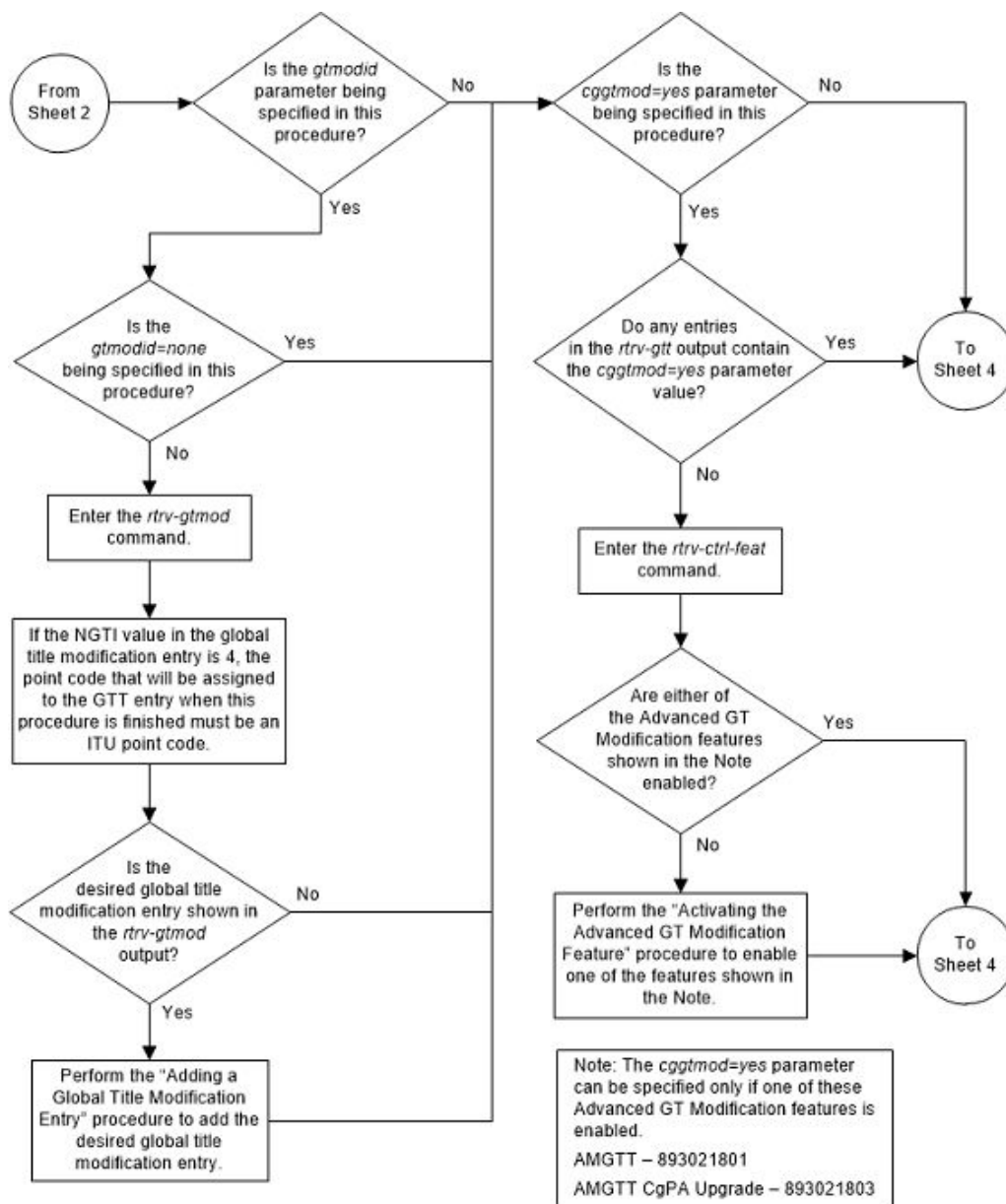

Figure 3-26 Change a Global Title Translation - Sheet 4 of 14

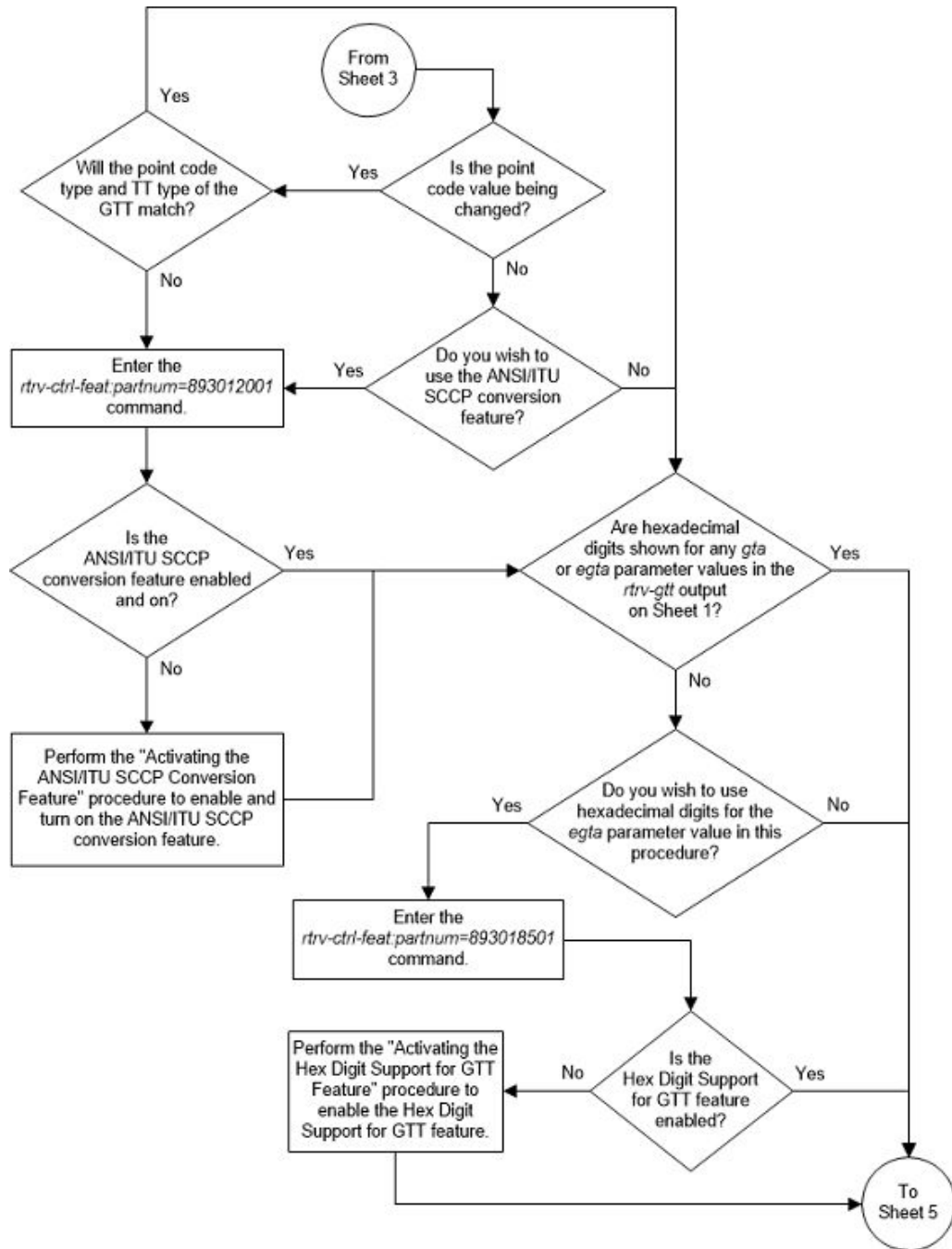

Figure 3-27 Change a Global Title Translation - Sheet 5 of 14

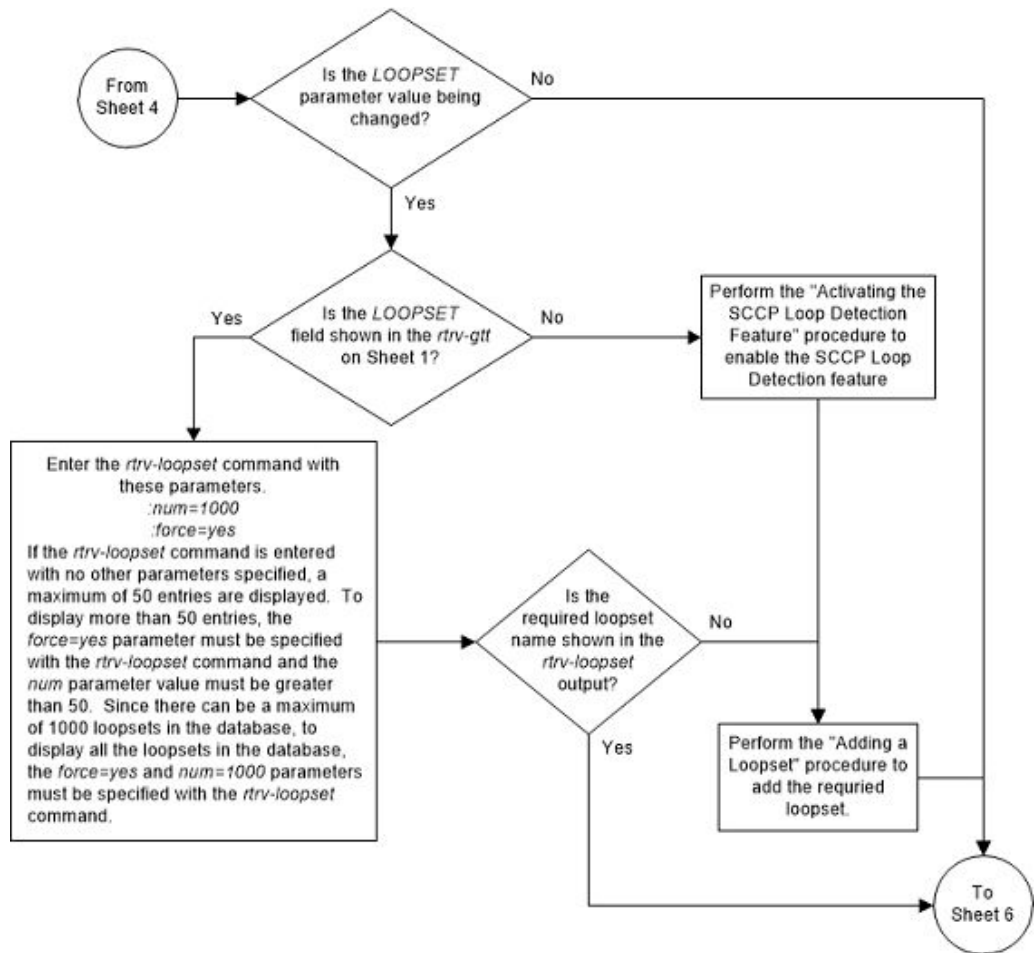

Figure 3-28 Change a Global Title Translation - Sheet 6 of 14

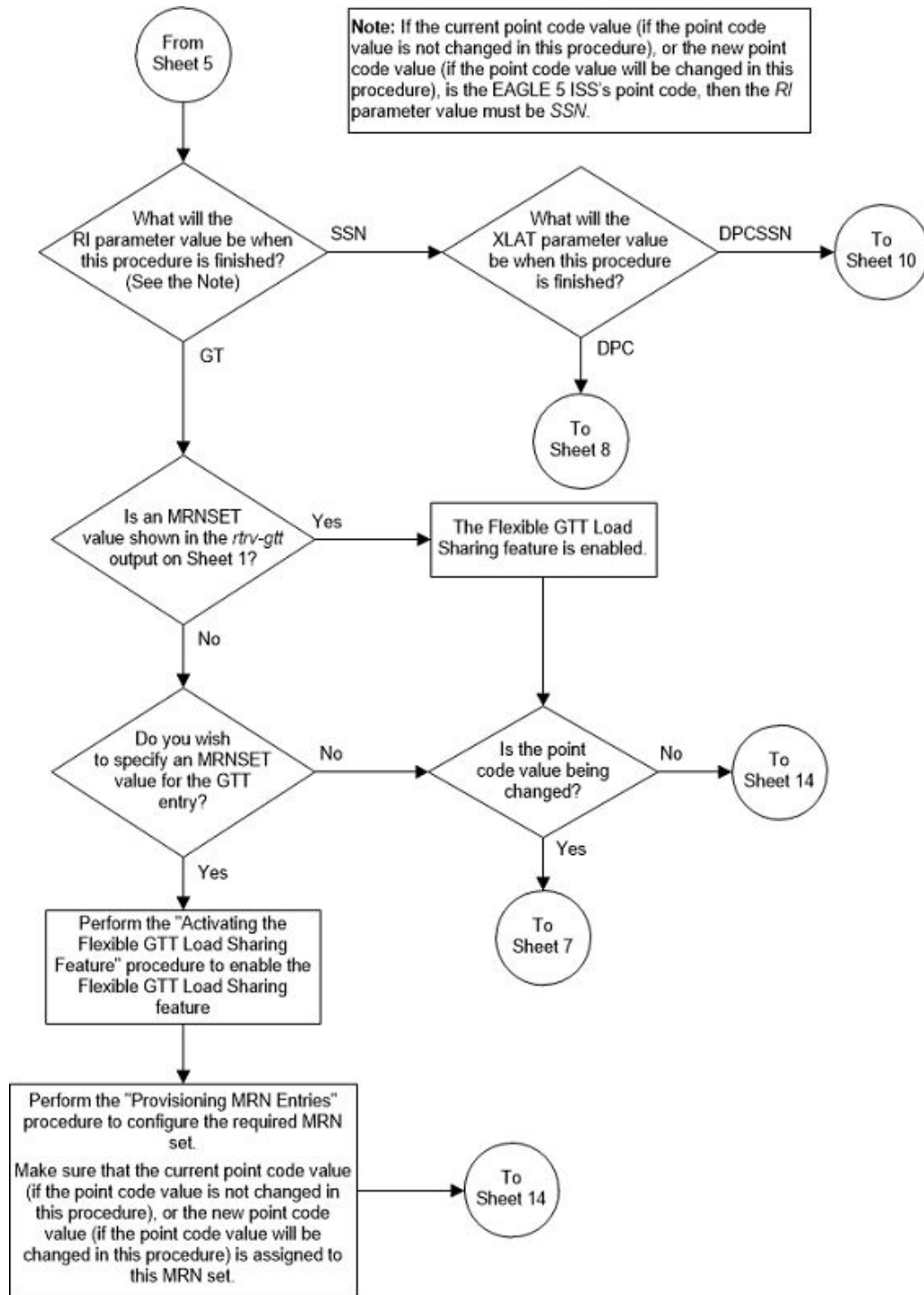

Figure 3-29 Change a Global Title Translation - Sheet 7 of 14

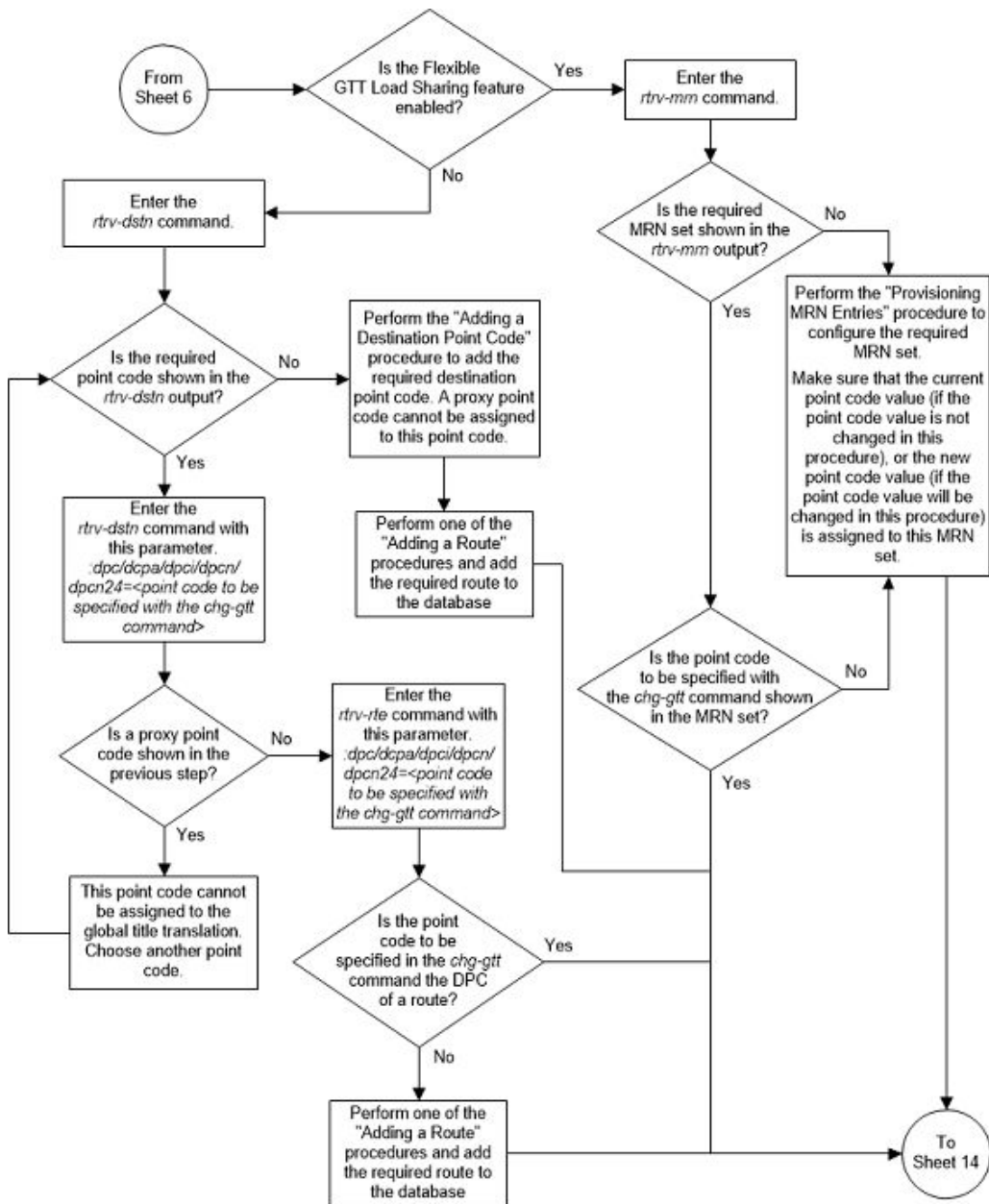

Figure 3-30 Change a Global Title Translation - Sheet 8 of 14

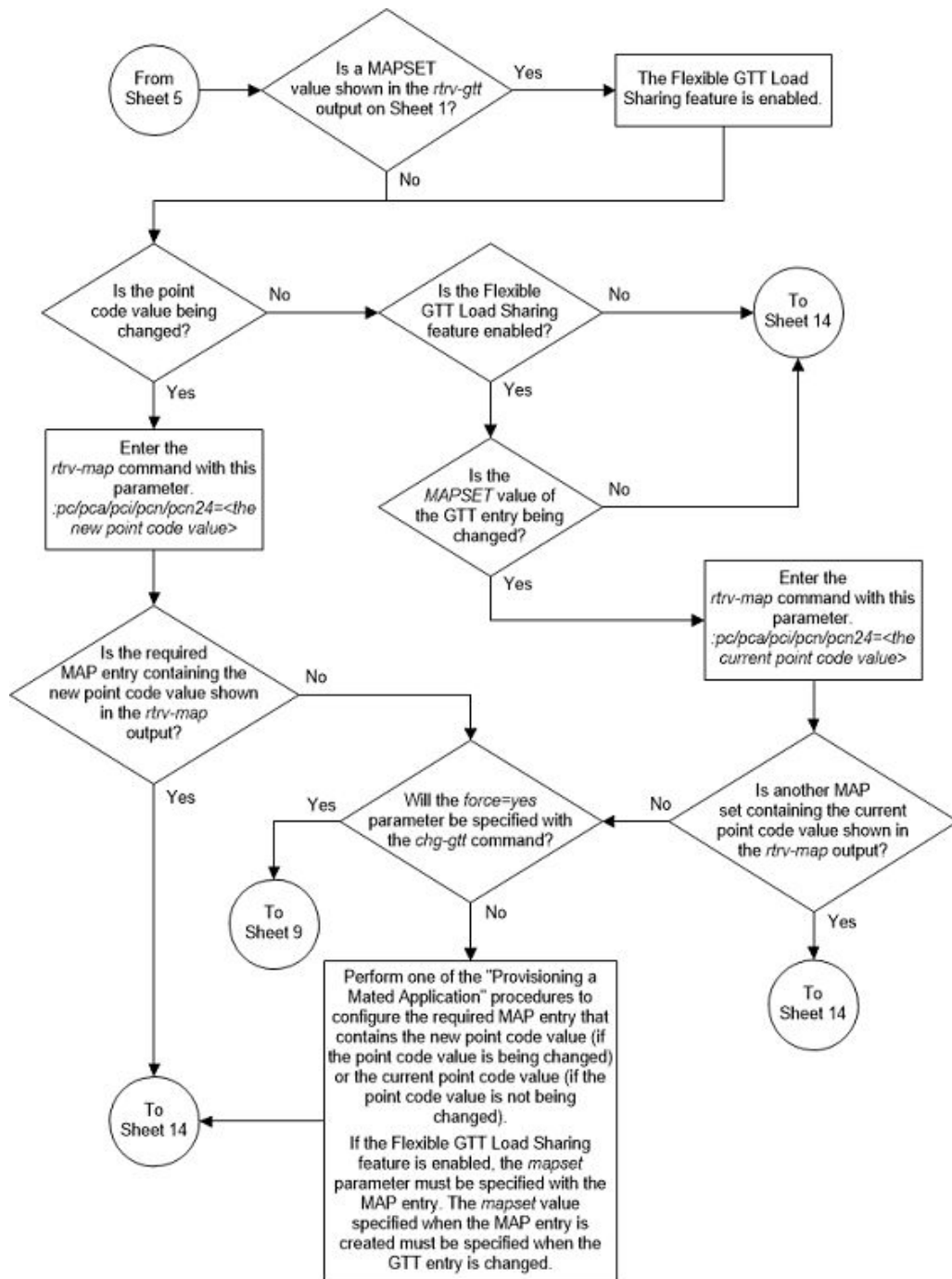

Figure 3-31 Change a Global Title Translation - Sheet 9 of 14

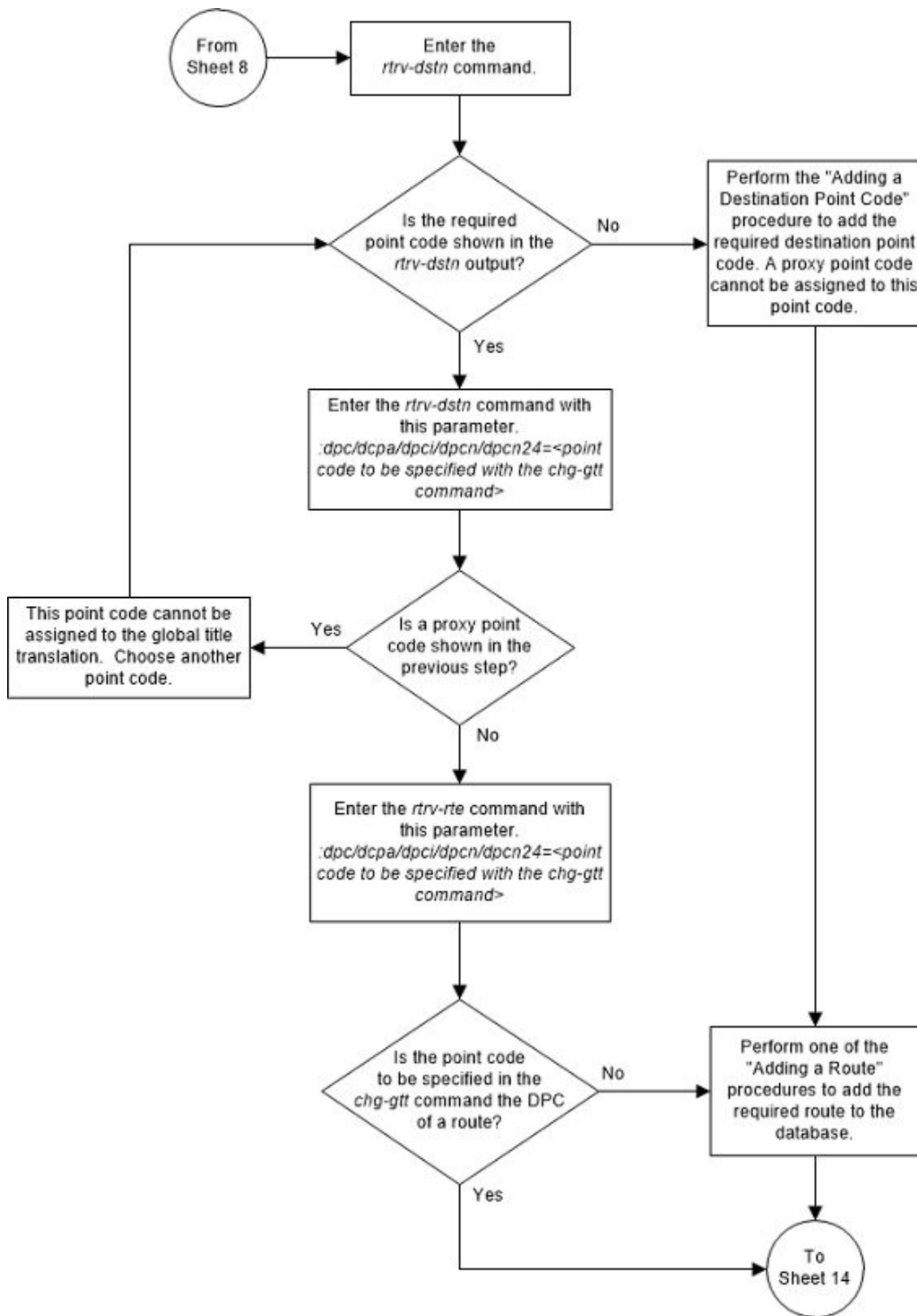

Figure 3-32 Change a Global Title Translation - Sheet 10 of 14

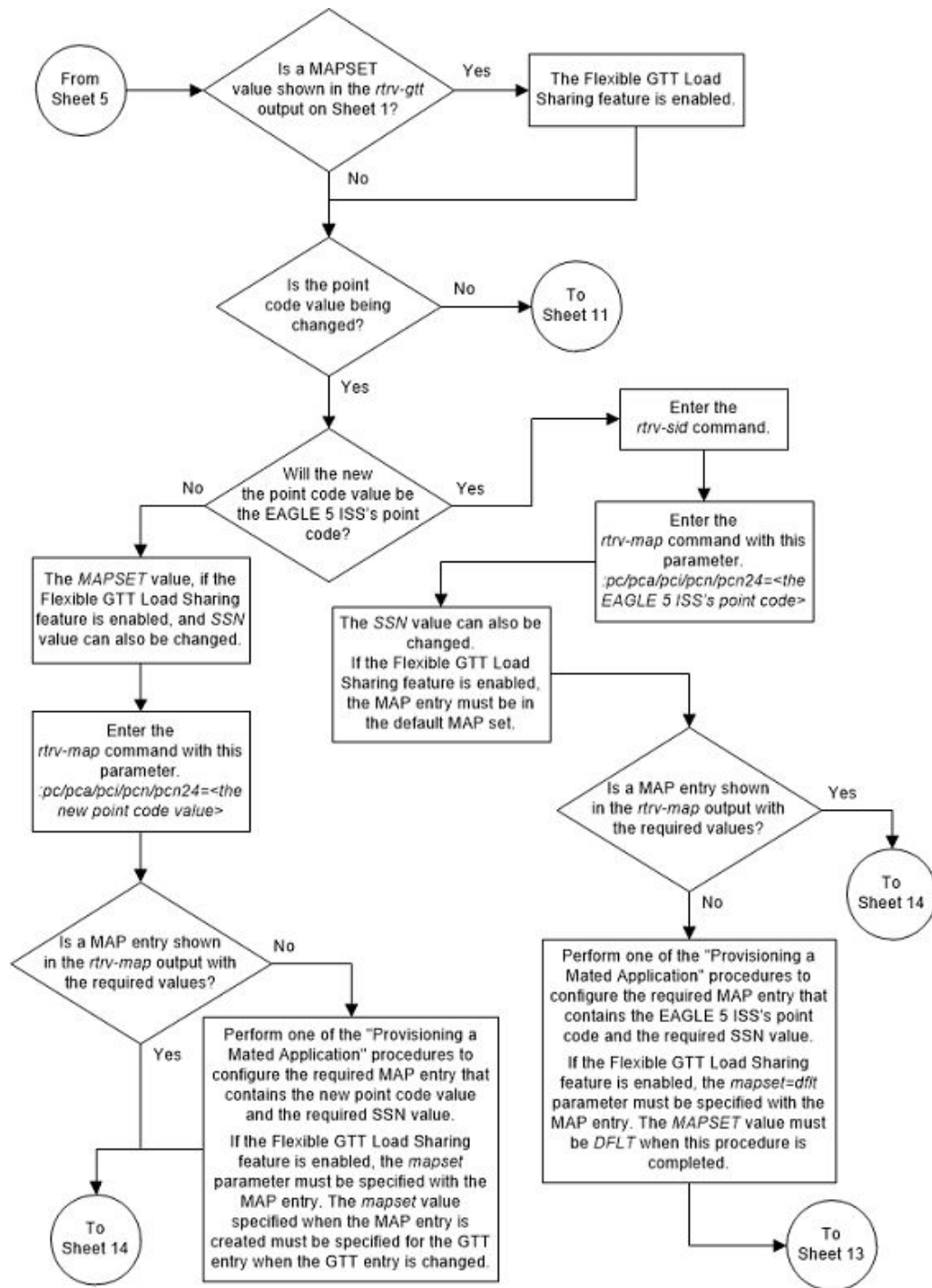

Figure 3-33 Change a Global Title Translation - Sheet 11 of 14

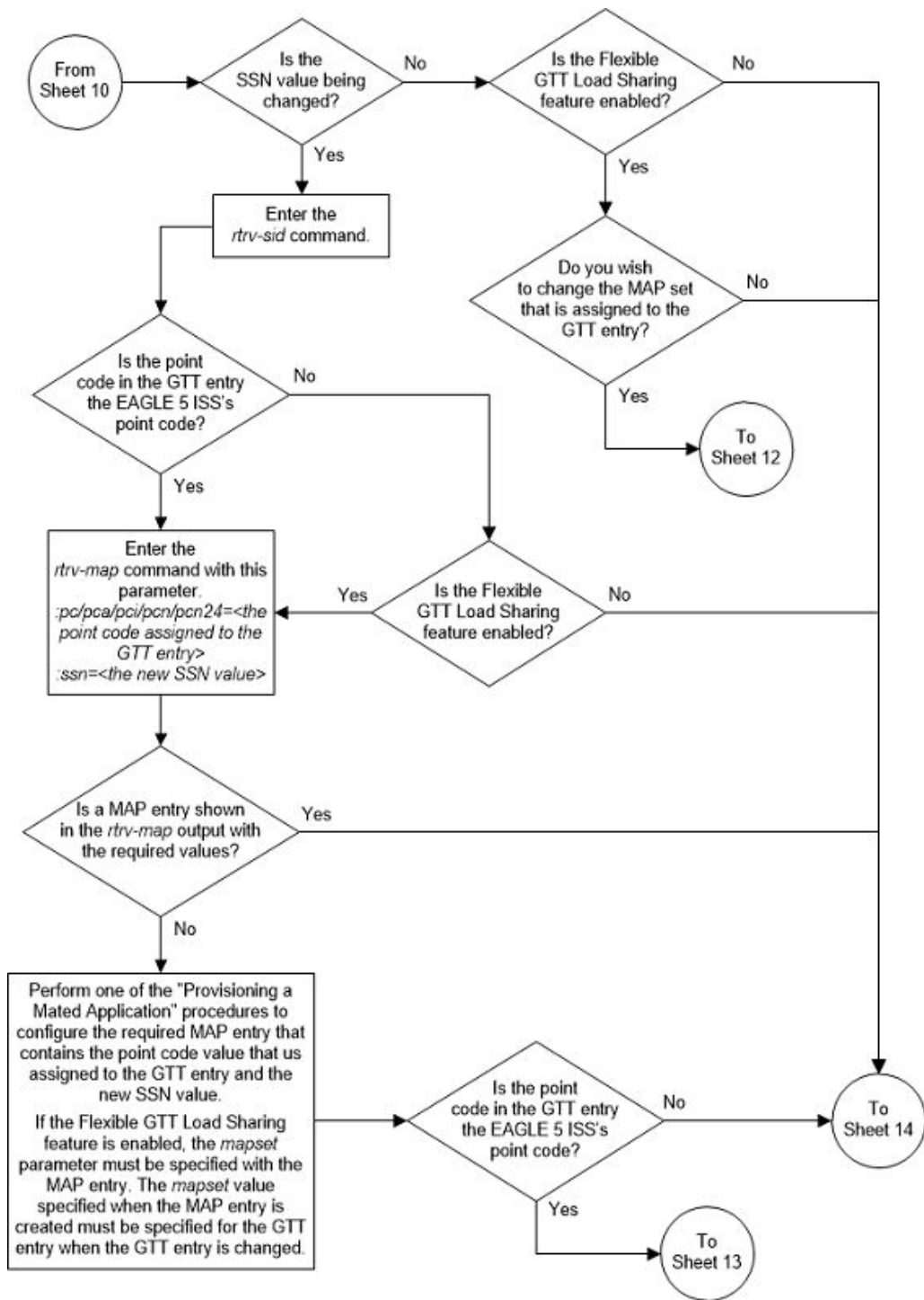

Figure 3-34 Change a Global Title Translation - Sheet 12 of 14

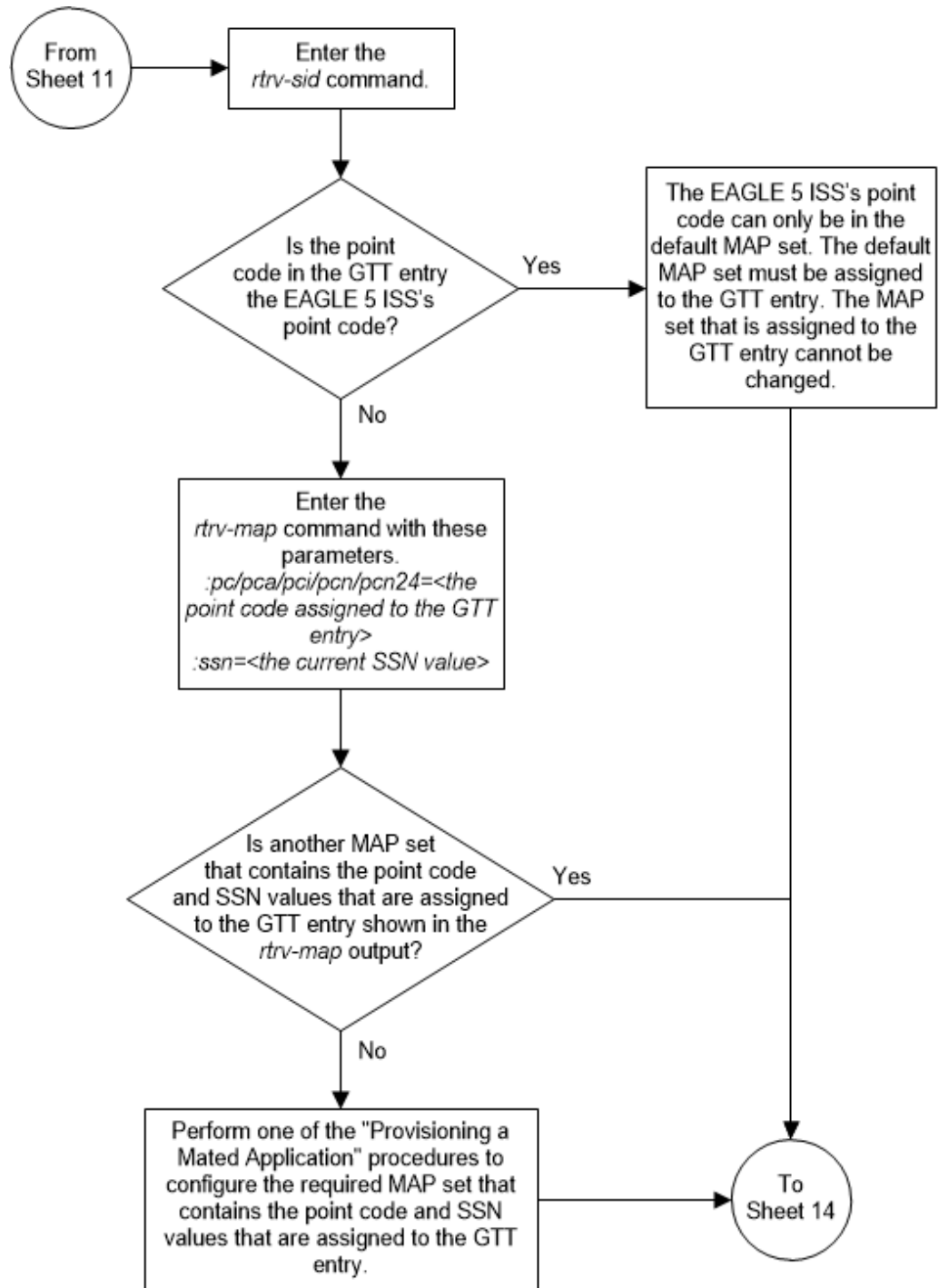

Figure 3-35 Change a Global Title Translation - Sheet 13 of 14

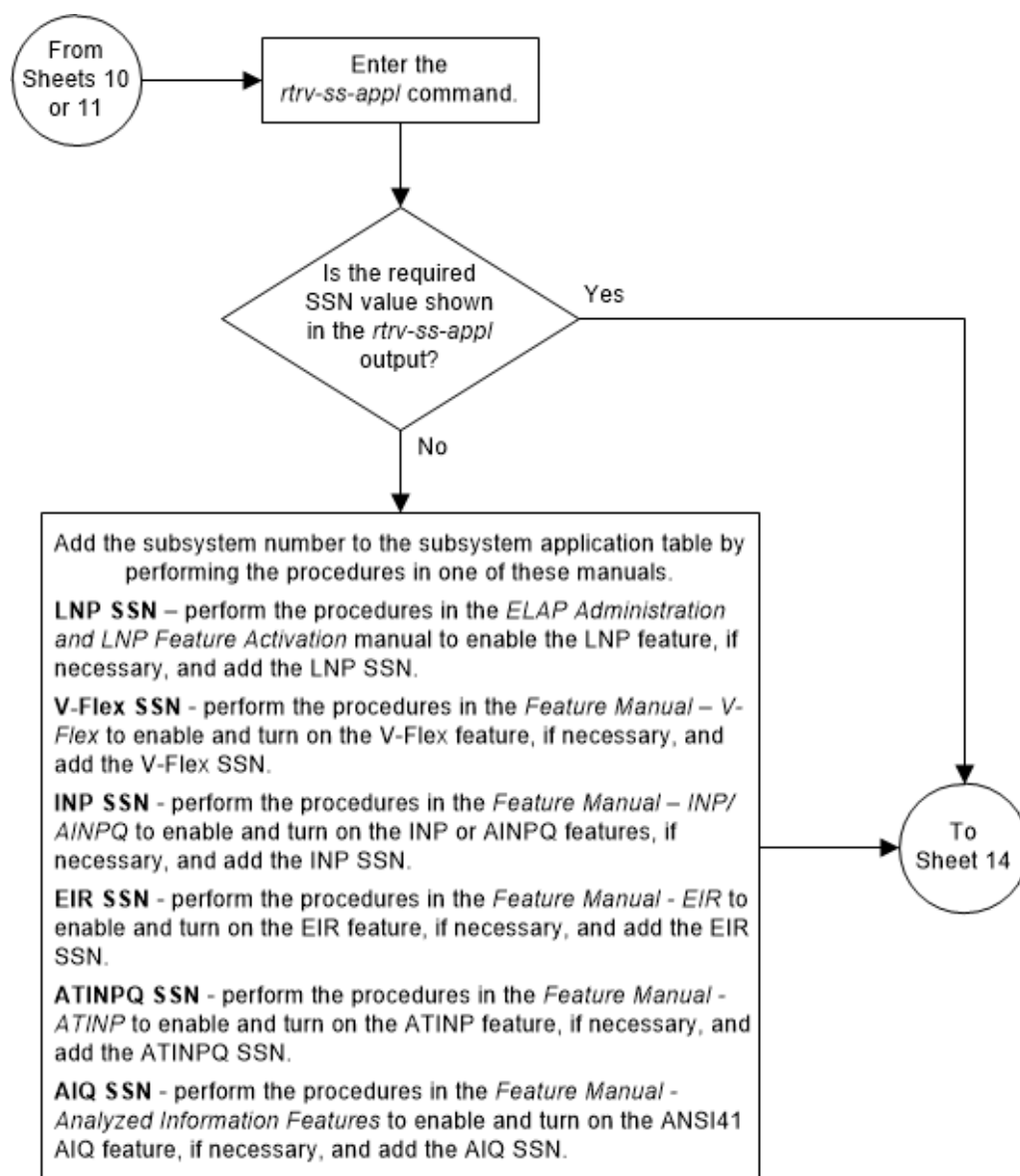
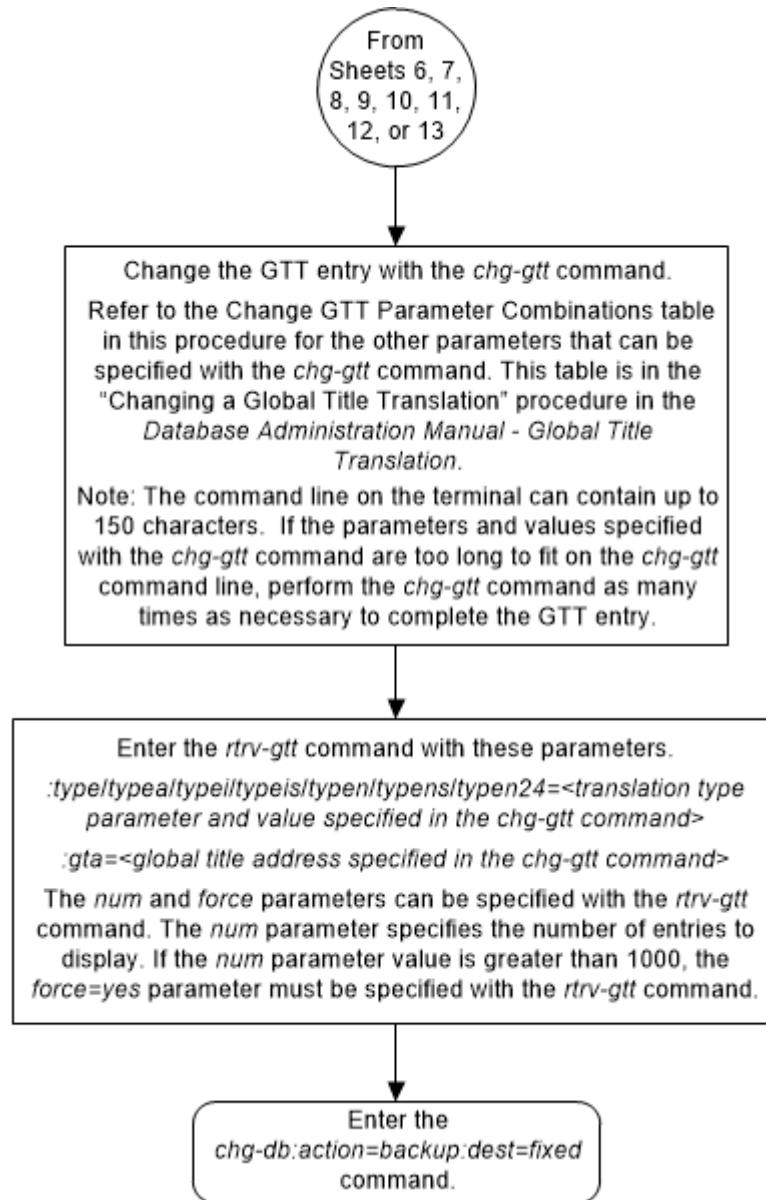

Figure 3-36 Change a Global Title Translation - Sheet 14 of 14



4

Enhanced Global Title Translation (EGTT) Configuration

Chapter 4, Enhanced Global Title Translation (EGTT) Configuration, contains the procedures specific to configure the enhanced global title translation feature.

Introduction

This chapter describes the procedures needed to add, remove, or change enhanced global title translation (EGTT) data in the database.

The items configured in this section are:

- GTT selectors
- GTT sets
- Global title addresses.
- GTT action sets
- GTT action per-path measurements

The following items must also be configured for the Enhanced Global Title Translation feature. The procedures to configure these items are located in the [Global Title Translation \(GTT\) Overview](#) section.

- Service modules
- Translation type mapping
- Concerned signaling point codes
- Mate applications
- Mated relay node groups
- GT Conversion Table Entries for the ANSI/ITU SCCP Conversion feature.
- Loopsets for the SCCP Loop Detection feature.
- GT modification identifiers for the Advanced GT Modification feature.

The procedures shown in this chapter use a variety of commands. For more information on these commands, refer to *Commands User's Guide*.

Notes:

1. Before turning the Enhanced Global Title Translation (EGTT) feature on with the `chg-feat:egtt=on` command, make sure you have purchased this feature. If you are not sure whether you have purchased the EGTT feature, contact your Oracle Sales Representative or Account Representative.
2. The GTT feature has to be turned on (`chg-feat:gtt=on` command) but not configured before the Enhanced Global Title Translation (EGTT) feature is enabled. If the GTT feature has been configured previously, enabling the EGTT

feature will upgrade the GTT database. For more information on the upgrade process, refer to the [Upgrading from Global Title Translation \(GTT\) to Enhanced Global Title Translation \(EGTT\)](#) section.

3. The translation type (`ent-/dlt-/rtrv-tt`) and the GTT (`ent-/dlt-/chg-/rtrv-gtt`) commands can be executed when the EGTT feature is turned on, but will only produce CDGTA GTT sets and CDGTA GTT selectors. For more details on using these commands while the EGTT feature is turned on, refer to the [Global Title Translation \(GTT\) Configuration](#) section.

Adding a GTT Set

Use this procedure to add a global title translation (GTT) set to the database using the `ent-gttset` command. Subsequent global title selector (`gttset`) or global title address (`gta`) commands may then be entered.

The `ent-gttset` command uses these parameters.

`:gttsn` – The GTT set name consisting of one alphabetic character and up to eight alphanumeric characters.

`:netdom` – The network domain of the global title translation set, either ANSI, ITU, or CROSS. The network domain CROSS can be specified only if the ANSI/ITU SCCP Conversion feature, part number 893012001, is enabled. The CROSS GTT set can be assigned to either an ANSI or ITU GTT selector.

Note:

The ITU domain does not distinguish between ITU-N (either ITU-N or ITU-N24) and ITU-I since the Enhanced Global Title Translation (EGTT) database does not yet distinguish ITU-National and ITU-International translations.

`:ndgt` – The number of digits contained in the global title translation.

`:settype` – The type of GTT set being added in this procedure shown in [Table 4-1](#).

Table 4-1 GTT Set Types

SETTYPE Value	Feature Requirements
CDGTA, CGGTA, CGPC, CGSSN, or OPC	The Origin-Based SCCP Routing feature must be enabled.
CDSSN or DPC	The Flexible Linkset Optional Based Routing feature must be enabled and turned on.
OPCODE	The TCAP Opcode Based Routing feature must be enabled and turned on.

The Global Title Translation (GTT) and the Enhanced Global Title Translation (EGTT) features must be `on` before using this command. Use the `rtrv-feat` command to verify the settings. If the features are off, perform the [Adding a Service Module](#) procedure to turn these features on and to make sure that the correct hardware is installed to support these features.

 **Note:**

Once the Global Title Translation (GTT) feature and the Enhanced Global Title Translation (EGTT) feature are turned on with the `chg-feat` command, they cannot be turned off.

The GTT feature and the EGTT feature must be purchased before you turn these features on. If you are not sure whether you have purchased the GTT feature and/or the EGTT feature, contact your Oracle Sales Representative or Account Representative.

The GTT set name (`gttset`) may not already exist and must be specified with the domain. The GTT set table may not have more than 2000 entries.

If the Variable-length Global Title Translation Feature (VGTT) is on, shown by the entry `VGTT = on` in the `rtv-feat` command output, or the Support for 16 GTT Lengths in VGTT feature is enabled and turned on, the `ndgt` parameter cannot be specified with the `ent-gttset` command. If the VGTT feature is on, a GTT set can contain a maximum of 10 different length global title addresses. If the Support for 16 GTT Lengths in VGTT feature is enabled and turned on, a GTT set can contain a maximum of 16 different length global title addresses. The length of the global title address is determined when the global title address is entered with the `ent-gta` command. For more information on the VGTT feature and the length of global title addresses, refer to the [Variable-length Global Title Translation Feature](#) section and the [Adding Global Title Address Information](#) procedure.

The VGTT functionality is supported only for CDPA GTT sets (`settype=cdgta`) and CGPA GTT sets (`settype=cggta`).

Table 4-2 GTT Set Parameter Combinations - Only the EGTT feature is on

SCCP Conversion Not Enabled VGTT=off	SCCP Conversion Not Enabled VGTT=on or Support for 16 GTT Lengths for VGTT is Enabled and Turned On	SCCP Conversion Enabled VGTT=off	SCCP Conversion Enabled VGTT=on or Support for 16 GTT Lengths for VGTT is Enabled and Turned On
Mandatory Parameters			
GTTSN NETDOM = ANSI, ITU	GTTSN NETDOM = ANSI, ITU	GTTSN NETDOM = CROSS, ANSI, ITU	GTTSN NETDOM = CROSS, ANSI, ITU
Optional Parameter			
NDGT	NDGT		
Notes:			
SCCP Conversion refers to the ANSI/ITU SCCP Conversion feature - part number 893012001			
VGTT refers to the Variable Global Title Translation feature			
Parameter Values:			
GTTSN = the GTT Set Name consisting of 1 to 9 alpha-numeric characters - the first character must be a letter, the remaining characters must be letters or numbers. The <code>gttset</code> value cannot be the word <code>none</code> .			
NDGT = the number of digits in the global title address - 1 to 21. The default value is 6.			

Table 4-3 GTT Set Parameter Combinations - The OBSR Feature is Enabled, the FLOBR or the TOBR Features are Enabled or Turned On

SCCP Conversion Not Enabled VGTT=off	SCCP Conversion Not Enabled VGTT=on or Support for 16 GTT Lengths for VGTT is Enabled and Turned On (See Note 3)	SCCP Conversion Enabled VGTT=off	SCCP Conversion Enabled VGTT=on or Support for 16 GTT Lengths for VGTT is Enabled and Turned On (See Note 3)
Mandatory Parameters			
GTTSN	GTTSN	GTTSN	GTTSN
NETDOM = ANSI, ITU	NETDOM = ANSI, ITU	NETDOM = CROSS, ANSI, ITU (See Note 2)	NETDOM = CROSS, ANSI, ITU (See Note 2)
SETTYPE - the GTT set type shown in Table 4-1 (See Note 4)	SETTYPE - the GTT set type shown in Table 4-1 (See Note 4)	SETTYPE - the GTT set type shown in Table 4-1 (See Note 4)	SETTYPE - the GTT set type shown in Table 4-1 (See Note 4)
Optional Parameter			
NDGT (See Note 1)		NDGT (See Note 1)	

Notes:

OBSR refers to the Origin-Based SCCP Routing feature

FLOBR refers to the Flexible Linkset Optional Based Routing feature

TOBR refers to the TCAP Opcode Based Routing feature

SCCP Conversion refers to the ANSI/ITU SCCP Conversion feature - part number 893012001

VGTT refers to the Variable Global Title Translation feature

Parameter Values:

GTTSN = the GTT Set Name consisting of 1 to 9 alpha-numeric characters - the first character must be a letter, the remaining characters must be letters or numbers. The `gttsn` value cannot be the word `none`.

NDGT = the number of digits in the global title address - 1 to 21.

1. The NDGT parameter can be specified only if the SETTYPE parameter value is either CDGTA or CCGTA. The default value is 6.
2. The NETDOM=CROSS parameter can be specified only if the SETTYPE parameter is CDGTA, and only if the ANSI/ITU SCCP Conversion feature is enabled.
3. VGTT functionality is supported only if the SETTYPE parameter value is either CDGTA or CCGTA.
4. If the GTT set name will be specified as the value for the BPARTYGTTSN parameter of either the `chg-gsmsmsopts` or `chg-is41smsopts` commands, the `settype` parameter value for this GTT set name must be `cdgta`.

1. Display the GTT sets in the database by entering the `rtrv-gttset` command. This is an example of the possible output.

```
rlghncxa03w 09-07-07 00:29:31 GMT EAGLE5 41.1.0
```

```
GTTSN      NETDOM  SETTYPE  NDGT
cdgta1     ansi    CDGTA    6
opcode1    ansi    OP CODE  -
opcode2    ansi    OP CODE  -
opcode3    ansi    OP CODE  -
```

```

cdssn1      ansi    CDSSN      -
cggta1      ansi    CGGTA      0
cdgtt2      itu     CDGTA      0
cgpc1       ansi    CGPC       -
cgpc2       ansi    CGSSN      -
cgssn2      ansi    CGSSN      -
opc2        ansi    OPC        -
opcode6     itu     OP CODE    -
opcode7     itu     OP CODE    -
cdssn6      itu     CDSSN      -
cdssn7      itu     CDSSN      -

```

GTT-SET table is (15 of 2000) 1% full.

If GTT sets are shown in this step, or error message “E3557 Cmd Rej: EGTT must be ON before this command can be entered” is not displayed, continue the procedure with 2.

If error message is displayed, “E3557 Cmd Rej: EGTT must be ON before this command can be entered,” the EGTT feature is not on. Perform the [Adding a Service Module](#) procedure to turn the EGTT feature on and to make sure that the correct hardware is installed and provisioned. After the [Adding a Service Module](#) procedure has been performed, continue the procedure with 2.

2. To specify any of these parameters or values for the GTT set, the feature that corresponds to the parameter or value must be shown as enabled, and turned on if required, in the `rtrv-ctrl-feat` output.

Perform the procedure, shown in this list, that corresponds to the parameters and values that you wish to specify for the GTT set.

- `settype` - one of these features shown in [Table 4-4](#) must be enabled, and turned on if necessary. If the `SETTYPE` column is not shown in the `rtrv-gttset` output and you wish to use the `settype` parameter, one of the features shown in [Table 4-4](#) must be enabled and turned on, if necessary. If the `settype` column is shown in the `rtrv-gttset` output in 1, the `settype` parameter must be specified with the `ent-gttset` command.

Table 4-4 SETTYPE Feature Requirements

SETTYPE Value	Feature Requirements	Procedure to Verify the Feature's Status and to Enable, and Turn On the Feature
CDGTA, CGGTA, CDSSN, CGPC, or OPC	Origin-Based SCCP Routing feature must be enabled.	Activating the Origin-Based SCCP Routing Feature – See the Note.
CDSSN or DPC	The Flexible Link set Optional Based Routing feature must be enabled and turned on.	Activating the Flexible Linkset Optional Based Routing Feature – See the Note.
OPCODE	TCAP Opcode Based Routing feature must be enabled and turned on.	Activating the TCAP Opcode Based Routing Feature – See the Note.

Table 4-4 (Cont.) SETTYPE Feature Requirements

SETTYPE Value	Feature Requirements	Procedure to Verify the Feature's Status and to Enable, and Turn On the Feature
---------------	----------------------	---

Note: If the desired SETTYPE value is shown in the `rtrv-gttset` output for any GTT set, the required feature is enabled, and turned on if required. The procedure for activating the feature does not need to be performed.

- `netdom=cross` - the ANSI/ITUANSI/ITU SCCP Conversion feature must be enabled. Perform the [Activating the ANSI/ITU SCCP Conversion Feature](#) procedure to verify the status of the ANSI/ITU SCCP Conversion feature and to enable the ANSI/ITU SCCP Conversion feature if necessary. If the `CROSS` value is shown in the `NETDOM` column of the `rtrv-gttset` output for any GTT set, the [Activating the ANSI/ITU SCCP Conversion Feature](#) procedure does not need to be performed.
- The Support for 16 GTT Lengths in VGTT feature must be enabled and turned on, if the GTT set will contain 11 to 16 different GTA lengths. Perform the [Activating the Support for 16 GTT Lengths in VGTT Feature](#) procedure to verify the status of the Support for 16 GTT Lengths in VGTT feature and to enable and turn on the Support for 16 GTT Lengths in VGTT feature if necessary. If GTT sets containing 11 to 16 different GTA lengths are shown in the `rtrv-gttset`, the [Activating the Support for 16 GTT Lengths in VGTT Feature](#) procedure does not need to be performed.

Continue the procedure by performing one of these steps.

- If the Support for 16 GTT Lengths in VGTT feature is enabled and turned on or the [Activating the Support for 16 GTT Lengths in VGTT Feature](#) procedure was performed in this step, continue the procedure with 5.
 - If the Support for 16 GTT Lengths in VGTT feature is not enabled or turned on and the [Activating the Support for 16 GTT Lengths in VGTT Feature](#) procedure was not performed in this step, continue the procedure by performing one of these steps.
 - If the GTT set will contain two to 10 different GTA lengths, the VGTT feature must be turned on. If GTA sets containing two to 10 different GTA lengths are shown in the `rtrv-gttset` output, the VGTT feature is turned on. Continue the procedure with 5.
 - If the GTT set will contain two to 10 different GTA lengths, and no GTT sets are shown in the `rtrv-gttset` output that contain two to 10 different GTA lengths, continue the procedure with 3.
 - If the GTT set will contain GTAs that have only one length, continue the procedure with 5.
3. Verify that the VGTT feature is on by entering the `rtrv-feat` command. If the VGTT feature is on, the `VGTT` field should be set to `on`.

 **Note:**

The `rtrv-feat` command output contains other fields that are not used by this procedure. If you wish to see all the fields displayed by the `rtrv-feat` command, see the `rtrv-feat` command description in *Commands User's Guide*.

Continue the procedure by performing one of these steps.

- If the VGTT feature is on, continue the procedure with 5.
 - If the VGTT feature is off, continue the procedure with [Oracle](#).
4. Turn the VGTT feature on by entering this command.

```
chg-feat:vgtt=on
```

 **Note:**

Once the Variable-length Global Title Translation (VGTT) feature is turned on with the `chg-feat` command, it cannot be turned off. The VGTT feature must be purchased before you turn this feature on. If you are not sure whether you have purchased the VGTT feature, contact your Oracle Sales Representative or Account Representative.

When the `chg-feat` command has successfully completed, this message should appear.

```
rlghncxa03w 09-05-07 00:28:31 GMT EAGLE5 41.0.0
CHG-FEAT: MASP A - COMPLTD
```

5. Add the GTT sets to the database using the `ent-gttset` command.

[Table 4-2](#) and [Table 4-3](#) shows the parameter combinations that can be used with the `ent-gttset` command.

If only the EGTT feature is on for this example, enter these commands.

```
ent-gttset:gttsn=lidb:ndgt=10:netdom=ansi
ent-gttset:gttsn=t800:netdom=ansi:ndgt=6
ent-gttset:gttsn=si000:netdom=itu:ndgt=15
```

If the Origin-Based SCCP routing feature is enabled for this example, enter these commands.

```
ent-gttset:gttsn=cdgta1:ndgt=10:netdom=ansi:settype=cdgta
ent-gttset:gttsn=cgcta1:netdom=ansi:ndgt=6:settype=cgcta
ent-gttset:gttsn=cgpc1:netdom=itu:settype=cgpc
```

If the Flexible Linkset Optional Based Routing feature is enabled and turned on for this example, enter these commands.

```
ent-gttset:gttsn=cdssn1:netdom=ansi:settype=cdssn
```



```
ent-gttset:gttsn=dpc1:netdom=itu:settype=dpc
```

If the TCAP Opcode Based Routing feature is enabled and turned on for this example, enter these commands.

```
ent-gttset:gttsn=opcode1:netdom=ansi:settype=opcode
```

```
ent-gttset:gttsn=opcode2:netdom=itu:settype=opcode
```

When each of these commands have successfully completed, this message should appear.

```
rlghncxa03w 09-07-07 00:29:31 GMT EAGLE5 41.1.0
```

```
GTT-SET table is (24 of 2000) 1% full.
```

```
ENT-GTTSET: MASP A - COMPLTD
```

6. Verify the changes using the `rtrv-gttset` command with the `gttsn` parameter and value specified in 5.

For this example, enter these commands.

- a. `rtrv-gttset:gttsn=lidb`

```
rlghncxa03w 09-07-07 00:30:31 GMT EAGLE5 41.1.0
```

GTTSN	NETDOM	NDGT
lidb	ansi	10

```
GTT-SET table is (25 of 2000) 1% full.
```

- b. `rtrv-gttset:gttsn=t800`

```
rlghncxa03w 09-07-07 00:30:31 GMT EAGLE5 41.1.0
```

GTTSN	NETDOM	NDGT
t800	ansi	6

```
GTT-SET table is (25 of 2000) 1% full.
```

- c. `rtrv-gttset:gttsn=si000`

```
rlghncxa03w 09-07-07 00:30:31 GMT EAGLE5 41.1.0
```

GTTSN	NETDOM	NDGT
si000	itu	15

```
GTT-SET table is (25 of 2000) 1% full.
```

- d. `rtrv-gttset:gttsn=cdgtal`

```
rlghncxa03w 09-07-07 00:30:31 GMT EAGLE5 41.1.0
```

GTTSN	NETDOM	SETTYPE	NDGT
cdgtal	ansi	CDGTA	10

GTT-SET table is (25 of 2000) 1% full.

e. rtrv-gttset:gttsn=cggtal

rlghncxa03w 09-07-07 00:30:31 GMT EAGLE5 41.1.0

GTTSN	NETDOM	SETTYPE	NDGT
cggtal	ansi	CGGTA	6

GTT-SET table is (25 of 2000) 1% full.

f. rtrv-gttset:gttsn=cgpc1

rlghncxa03w 09-07-07 00:30:31 GMT EAGLE5 41.1.0

GTTSN	NETDOM	SETTYPE	NDGT
cgpc1	itu	CGPC	-

GTT-SET table is (25 of 2000) 1% full.

g. rtrv-gttset:gttsn=cdssn1

rlghncxa03w 09-07-07 00:30:31 GMT EAGLE5 41.1.0

GTTSN	NETDOM	SETTYPE	NDGT
cdssn1	ansi	CDSSN	-

GTT-SET table is (25 of 2000) 1% full.

h. rtrv-gttset:gttsn=dpcl

rlghncxa03w 10-07-07 00:30:31 GMT EAGLE5 42.0.0

GTTSN	NETDOM	SETTYPE	NDGT
dpcl	itu	DPC	-

GTT-SET table is (25 of 2000) 1% full.

i. rtrv-gttset:gttsn=opcode1

rlghncxa03w 09-07-07 00:30:31 GMT EAGLE5 41.1.0

GTTSN	NETDOM	SETTYPE	NDGT
opcode1	ansi	OPCODE	-

GTT-SET table is (25 of 2000) 1% full.

j. rtrv-gttset:gttsn=opcode2

rlghncxa03w 09-07-07 00:30:31 GMT EAGLE5 41.1.0

GTTSN	NETDOM	SETTYPE	NDGT
opcode2	itu	OPCODE	-

GTT-SET table is (25 of 2000) 1% full.

Examples 1 through 3 are GTT sets that are provisioned when only the EGTT feature is on.

Examples 4 through 6 are GTT sets that are provisioned when the Origin-Based SCCP Routing feature is enabled.

Examples 7 and 8 are GTT sets that are provisioned when the Flexible Linkset Optional Based Routing feature is enabled and turned on.

Examples 9 and 10 are GTT sets that are provisioned when the TCAP Opcode Based Routing feature is enabled and turned on.

7. Backup the new changes using the `chg-db:action=backup:dest=fixed` command. These messages should appear, the active Maintenance and Administration Subsystem Processor (MASP) appears first.

```
BACKUP (FIXED) : MASP A - Backup starts on active MASP.
```

```
BACKUP (FIXED) : MASP A - Backup on active MASP to fixed disk complete.
```

```
BACKUP (FIXED) : MASP A - Backup starts on standby MASP.
```

```
BACKUP (FIXED) : MASP A - Backup on standby MASP to fixed disk complete.
```

Figure 4-1 Add a GTT Set - Sheet 1 of 2

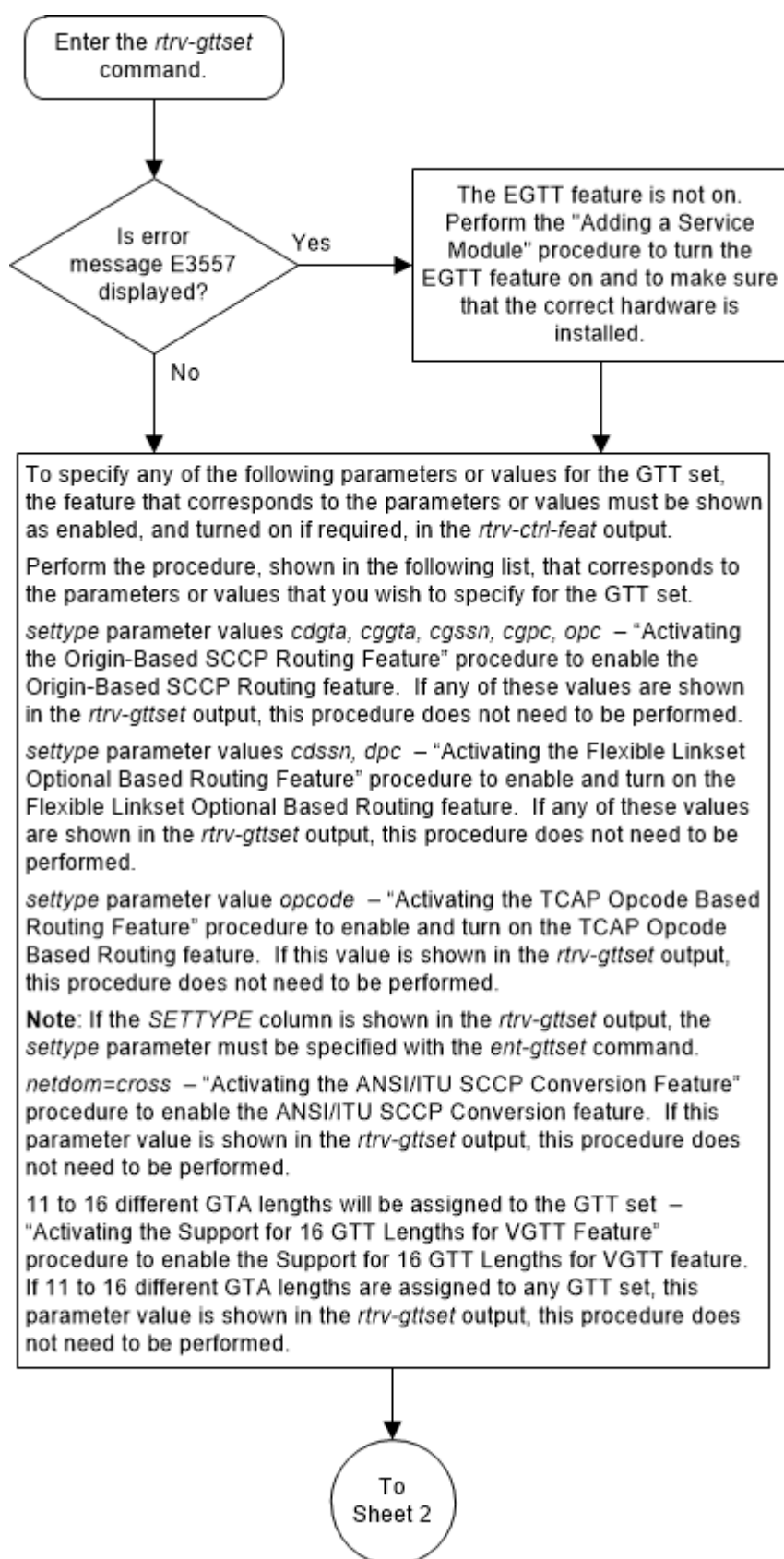
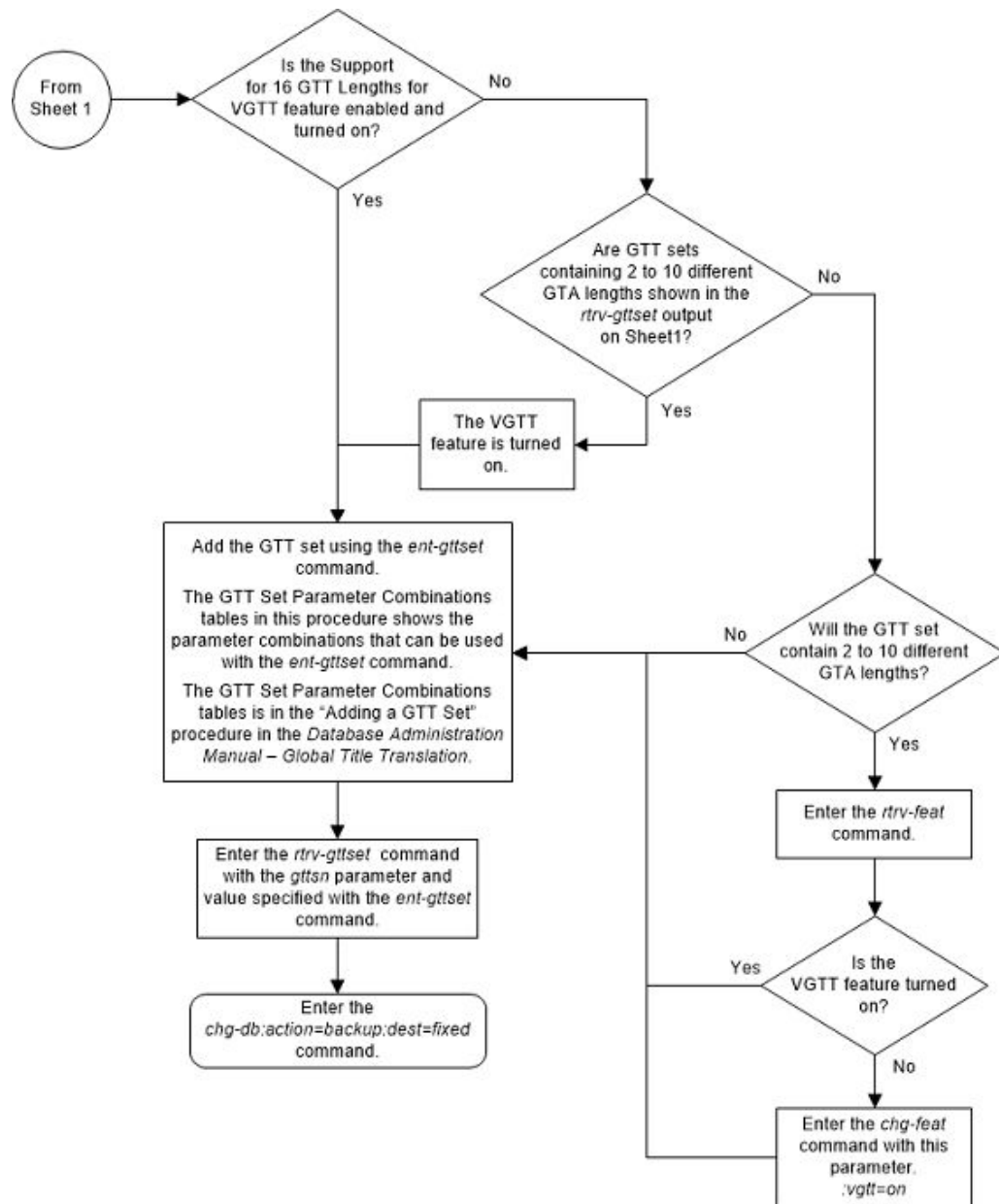

Figure 4-2 Add a GTT Set - Sheet 2 of 2



Removing a GTT Set

Use this procedure to remove a GTT Set from the database using the `dlt-gttset` command.

The `dlt-gttset` command uses this parameter.

`:gttsn` – The GTT set name.

The GTT set name (`gttsn`) must be specified and match an existing GTT set. Use the `rtrv-gttset` command to view the GTT set names.

The GTT set name cannot be removed from the database if the name is referenced by any of these entities.

- **GTT Selectors** - Use the `rtrv-gttset:gttsn=<GTT set name>` command to view the GTT selectors using the specified GTT set name. If any GTT selectors are assigned to this GTT set name, perform the procedure [Removing a GTT Selector](#) to remove the selector from the database.
- **GTA entries** - Use the `rtrv-gta:gttsn=<GTT set name>` command to view the global title address information using the specified GTT set name. If any GTAs are assigned to this GTT set name, perform the procedure [Removing Global Title Address Information](#) to remove the global title address information from the database.
- The GTT set name cannot be shown in the `rtrv-gsmsmsopts` or `rtrv-is41smsopts` output as the `BPARTYGTTSN` value. Perform the procedure [Configuring the GSM MO SMS B-Party Routing Options](#) or the procedure [Configuring the IS-41 MO SMS B-Party Routing Options](#) to remove the GTT set name as the `BPARTYGTTSN` value.
- The GTT set name cannot be shown in the `rtrv-gsmsmsopts` output as the `IS41SMSCGTTSN` value. Perform the procedures in *IS41 GSM Migration User's Guide* to remove the GTT set name as the `IS41SMSCGTTSN` value.

The examples in this procedure are used to remove the GTT set name `t800` from the database.

1. Display the existing GTT sets in the database by entering this command.

```
rtrv-gttset:refcnt=yes
```

This is an example of the possible output.

```
rlghncxa03w 10-07-07 00:27:31 GMT EAGLE5 42.0.0
```

GTTSN	NETDOM	SETTYPE	REFCNT	NDGT
abcd1234	itu	CDGTA	3	12
dpcl	itu	DPC	0	-
gttset1	ansi	CDGTA	1	6
gttset2	ansi	CGGTA	5	10
gttset3	ansi	OPC	0	-
gttset4	ansi	CGPC	2	-
gttset5	itu	CGPC	2	-
imsi	itu	CDGTA	3	15
lidb	ansi	CDGTA	4	10
si000	itu	CDGTA	3	15
t800	ansi	CDGTA	13	10
gttset6	ansi	CDSSN	1	-
gttset7	itu	OPCODE	1	-

```
GTT-SET table is (13 of 2000) 1% full.
```

The `SETTYPE` column is not shown in the `rtrv-gttset` output if the Origin-Based SCCP Routing feature is not enabled or the Flexible Linkset Optional Based Routing or TCAP Opcode Based Routing features are not enabled or turned on.

If the Origin-Based SCCP Routing feature is not enabled, the values `CGGTA`, `CGPC`, `CGSSN`, and `OPC` are not shown in the `rtrv-gttset` output.

If the Flexible Linkset Optional Based Routing feature is not enabled and turned on, the values `CDSSN` or `DPC` are not shown in the `rtrv-gttset` output.

If the TCAP Opcode Based Routing feature is not enabled, the value `OPCODE` is not shown in the `rtrv-gttset` output.

If the reference count of the GTT set that is being removed is 0 (zero), continue the procedure with 7. The reference count of the GTT set shows the number of database entities that reference the GTT set. The reference count value is shown in the `REFCNT` column of the `rtrv-gttset` output.

If the reference count of the GTT set that is being removed is greater than 0 (zero), continue the procedure with 2.

2. Verify that no global title address information references the GTT set name being removed from the database. Use the `rtrv-gta` command with the `gttsn` parameter specifying the GTT set name being removed from the database. If the `num` parameter is specified with the `rtrv-gta` command, and the value of the `num` parameter is greater than 1000, the `force=yes` parameter must be specified with the `rtrv-gta` command. For this example, enter this command.

```
rtrv-gta:gttsn=t800
```

This is an example of the possible output.

```
rlghncxa03w 10-07-07 00:28:31 GMT EAGLE5 42.0.0
GTTSN      NETDOM  SETTYPE  NDGT
t800      ansi    CDGTA    10

GTA TABLE IS 1 % FULL (17 of 269999)

START GTA  END GTA  XLAT  RI  PC
8005550000 8005551999 dpcssn ssn  001-254-255
          SSN=255 CCGT=no CGGTMOD=NO
          GTMODID=----- TESTMODE=off
          OPTSN=----- CGSELID=----- OPCS=-----
          ACTSN=----- PPMEASREQD= NO
8005552000 8005553999 dpc  gt  001-254-255
          SSN=0 CCGT=no CGGTMOD=NO
          GTMODID=----- TESTMODE=off
          OPTSN=----- CGSELID=----- OPCS=-----
          ACTSN=----- PPMEASREQD= NO
8005554000 8005555999 dpcngt gt  001-254-255
          SSN=--- CCGT=no CGGTMOD=NO
          GTMODID=----- TESTMODE=off
          OPTSN=----- CGSELID=----- OPCS=gttset3
          ACTSN=----- PPMEASREQD= NO
8005556000 8005557999 dpcssn ssn  001-254-255
          SSN=255 CCGT=no CGGTMOD=NO
          GTMODID=----- TESTMODE=off
          OPTSN=----- CGSELID=----- OPCS=-----
          ACTSN=----- PPMEASREQD= NO
8005558000 8005559999 dpcssn ssn  001-254-255
          SSN=255 CCGT=yes CGGTMOD=NO
          GTMODID=----- TESTMODE=off
```

```

OPTSN=----- CGSELID=----- OPCS=-----
ACTSN=----- PPMEASREQD= NO
9195551212 9195551212 dpcssn ssn 008-001-001
SSN=222 CCGT=no CGGTMOD=NO
GTMODID=----- TESTMODE=off
OPTSN=----- CGSELID=----- OPCS=-----
ACTSN=----- PPMEASREQD= NO
9194600000 9194600000 dpc gt 001-255-252
SSN=0 CCGT=no CGGTMOD=NO
GTMODID=----- TESTMODE=off
OPTSN=----- CGSELID=----- OPCS=-----
ACTSN=----- PPMEASREQD= NO
9194610000 9194680000 dpcssn ssn 001-255-252
SSN=222 CCGT=no CGGTMOD=NO
GTMODID=----- TESTMODE=off
OPTSN=----- CGSELID=----- OPCS=-----
ACTSN=----- PPMEASREQD= NO
9762428487 9762428487 dpcssn ssn 001-254-255
SSN=222 CCGT=no CGGTMOD=NO
GTMODID=----- TESTMODE=off
OPTSN=----- CGSELID=----- OPCS=-----
ACTSN=----- PPMEASREQD= NO
9766423277 9766423277 dpcssn ssn 001-254-255
SSN=222 CCGT=no CGGTMOD=NO
GTMODID=----- TESTMODE=off
OPTSN=----- CGSELID=----- OPCS=-----
ACTSN=----- PPMEASREQD= NO
9769388928 9769388928 dpcssn ssn 001-254-255
SSN=222 CCGT=no CGGTMOD=NO
GTMODID=----- TESTMODE=off
OPTSN=----- CGSELID=----- OPCS=-----
ACTSN=----- PPMEASREQD= NO

```

Command Retrieved 11 Entries

If no global title address entries are shown in the `rtrv-gta` output, continue the procedure with [3](#).

If global title address entries are shown in the `rtrv-gta` output, perform [Removing Global Title Address Information](#) to remove any global title address entries that are shown in the `rtrv-gta` command output. Continue the procedure by performing one of these steps.

- If all the references to the GTT set have been removed, continue the procedure with [7](#).
 - If all the references to the GTT set have not been removed, continue the procedure with [3](#).
- 3.** Display the features that are enabled by entering the `rtrv-ctrl-feat` command.

The following is an example of the possible output.

```

rlghncxa03w 10-07-28 21:15:37 GMT EAGLE5 42.0.0
The following features have been permanently enabled:

```

Feature Name	Partnum	Status	Quantity
Command Class Management	893005801	on	----
LNP Short Message Service	893006601	on	----
Intermed GTT Load Sharing	893006901	on	----
HC-MIM SLK Capacity	893012707	on	64

The following features have been temporarily enabled:

Feature Name	Partnum	Status	Quantity	Trial
Period Left				
Zero entries found.				

The following features have expired temporary keys:

Feature Name	Partnum
Zero entries found.	

4. Display the GTT selectors in the database by entering the `rtrv-gttset` command with the `GTTSN` value of the GTT set that is being removed.

To specify of the `GTTSN` value of the GTT set, the parameters shown in [Table 4-5](#) must be specified with the `rtrv-gttset` command. The parameters that can be specified are dependent on the features that are enabled, shown in [3](#).

Table 4-5 RTRV-GTTSEL Parameters

Feature that is Enabled	Parameter that must be Specified for the TTN Value
Neither the Origin Based SCCP Routing nor the Flexible Linkset Optional Based Routing, shown as <code>Flex Lset Optnl Based Rtg</code> in the <code>rtrv-ctrl-feat</code> output, is enabled.	<code>gttsn</code>
Origin Based SCCP Routing	<code>cdgtasn, cggtsn</code>
Flexible Linkset Optional Based Routing	<code>cdgttsn, cggtsn</code>

For this example, enter this command if the Origin-Based SCCP Routing feature is not enabled and the Flexible Linkset Optional Based Routing feature is not enabled or turned on.

```
rtrv-gttset:gttsn=t800
```

This is an example of the possible output.

```
rlghncxa03w 07-05-07 00:29:31 GMT EAGLE5 37.0.0
GTIA TT NP NAI GTTSN
2 10 -- --- t800
```

If the Origin-Based SCCP Routing feature is enabled for this example, enter this command.

```
rtrv-gttset:cdgtasn=t800
```

This is an example of the possible output.

```
rlghncxa03w 09-05-07 00:29:31 GMT EAGLE5 41.0.0
GTI                CG                CDPA                CGPA
ANSI TT NP        NAI  SSN SELID LSN        GTTSET            GTTSET
2   10 --        ---  --- none  any        t800      (cdgta)
-----  (--- )
```

If the Flexible Linkset Optional Based Routing feature is enabled and turned on for this example, enter these commands.

```
rtrv-gttset:cdgttsn=t800
```

This is an example of the possible output.

```
rlghncxa03w 09-05-07 00:29:31 GMT EAGLE5 41.0.0
GTI                CG                CDPA                CGPA
ANSI TT NP        NAI  SSN SELID LSN        GTTSET            GTTSET
2   10 --        ---  any none  any        t800      (cdgta)
-----  (--- )
```

```
rtrv-gttset:cggtsn=t800
```

This is an example of the possible output.

```
rlghncxa03w 09-05-07 00:29:31 GMT EAGLE5 41.0.0
GTI                CG                CDPA                CGPA
ANSI TT NP        NAI  SSN SELID LSN        GTTSET            GTTSET
2   11 --        ---  any none  any        -----  (--- ) t800
(cggtta )
```

Continue the procedure by performing one of these steps.

- If no GTT selectors are shown in this step, continue the procedure with [5](#).
- If GTT selectors are shown in this step, perform [Removing a GTT Selector](#) to remove the GTT selectors that are shown in this step. After the GTT selectors have been removed, continue the procedure by performing one of these steps.
 - If all the references to the GTT set have been removed, continue the procedure with [7](#).
 - If all the references to the GTT set have not been removed, continue the procedure with [5](#).

5. Enter the `rtrv-gsmmssopts` command.

The following is an example of the possible output.

```
rlghncxa03w 10-04-28 21:15:37 GMT EAGLE5 42.0.0
GSM SMS OPTIONS
-----
BPARTYGTTSN = NONE                MOSMSGTTDIG = SCCPCDPA
```

```
MTSMSRLYGTTSN= NONE
IS41SMSCGTTSN= NONE
```

```
rlghncxa03w 09-07-28 21:15:37 GMT EAGLE5 41.1.0
GSM SMS OPTIONS
```

```
-----
BPARTYGTTSN   = NONE           MOSMSGTTDIG   = SCCPCDPA
IS41SMSCGTTSN= NONE
```

 **Note:**

The `rtrv-gsmsmsopts` command output contains other fields that are not used by this procedure. If you wish to see all the fields displayed by the `rtrv-gsmsmsopts` command, refer to the `rtrv-gsmsmsopts` command description in *Commands User's Guide*.

If the `BPARTYGTTSN` value contains a GTT set name, perform [Configuring the GSM MO SMS B-Party Routing Options](#) to change the `BPARTYGTTSN` value to `NONE`.

If the `IS41SMSCGTTSN` value contains a GTT set name, perform the procedures in *IS41 GSM Migration User's Guide* to change the `IS41SMSCGTTSN` value to `NONE`.

After the `BPARTYGTTSN` or `IS41SMSCGTTSN` values have been changed, or if the `BPARTYGTTSN` or `IS41SMSCGTTSN` values shown in the `rtrv-gsmsmsopts` output are `NONE`, continue the procedure by performing one of these steps.

- If all the references to the GTT set have been removed, continue the procedure with [7](#).
 - If all the references to the GTT set have not been removed, continue the procedure with [6](#).
6. Enter the `rtrv-is41smsopts` command.

The following is an example of the possible output.

```
rlghncxa03w 09-09-28 21:15:37 GMT EAGLE5 41.1.0
IS41 SMS OPTIONS
```

```
-----
BPARTYGTTSN   = NONE
MOSMSGTTDIG   = SCCPCDPA
```

 **Note:**

The `rtrv-is41smsopts` command output contains other fields that are not used by this procedure. If you wish to see all the fields displayed by the `rtrv-is41smsopts` command, refer to the `rtrv-is41smsopts` command description in *Commands User's Guide*.

If the `BPARTYGTTSN` value contains a GTT set name, perform [Configuring the IS-41 MO SMS B-Party Routing Options](#) to change the `BPARTYGTTSN` value to `NONE`.

After the `BPARTYGTTSN` value has been changed, or if the `BPARTYGTTSN` value shown in the `rtrv-is41smsopts` output is `NONE`, continue the procedure with 7.

7. Remove the GTT set from the database using the `dlt-gttset` command with the `gttsn` parameter specifying the GTT set name being removed from the database.

For this example, enter this command.

```
dlt-gttset:gttsn=t800
```

When the command has successfully completed, this message should appear:

```
rlghncxa03w 09-07-07 00:29:31 GMT EAGLE5 41.1.0
```

```
GTT-SET table is (11 of 2000) 1% full.
```

```
DLT-GTTSET: MASP A - COMPLTD
```

8. Verify the changes using the `rtrv-gttset` command with the `gttsn` parameter and GTT set name specified in 7.

The following message is displayed.

```
E3561 Cmd Rej: GTT Set specified by GTT Set Name/index does not exist
```

9. Backup the new changes using the `chg-db:action=backup:dest=fixed` command.

These messages should appear, the active Maintenance and Administration Subsystem Processor (MASP) appears first.

```
BACKUP (FIXED) : MASP A - Backup starts on active MASP.
```

```
BACKUP (FIXED) : MASP A - Backup on active MASP to fixed disk complete.
```

```
BACKUP (FIXED) : MASP A - Backup starts on standby MASP.
```

```
BACKUP (FIXED) : MASP A - Backup on standby MASP to fixed disk complete.
```

Figure 4-3 Remove a GTT Set - Sheet 1 of 2

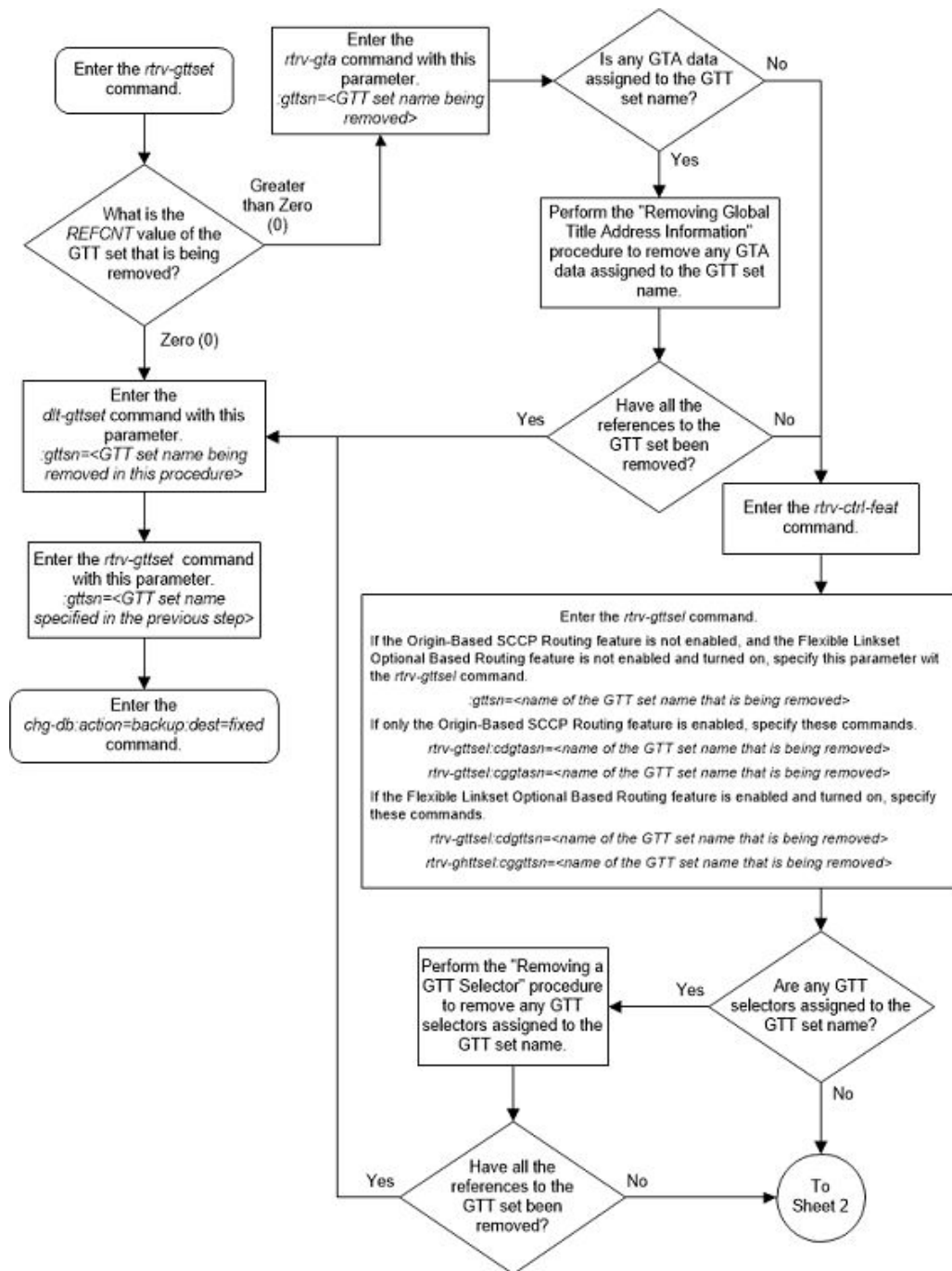
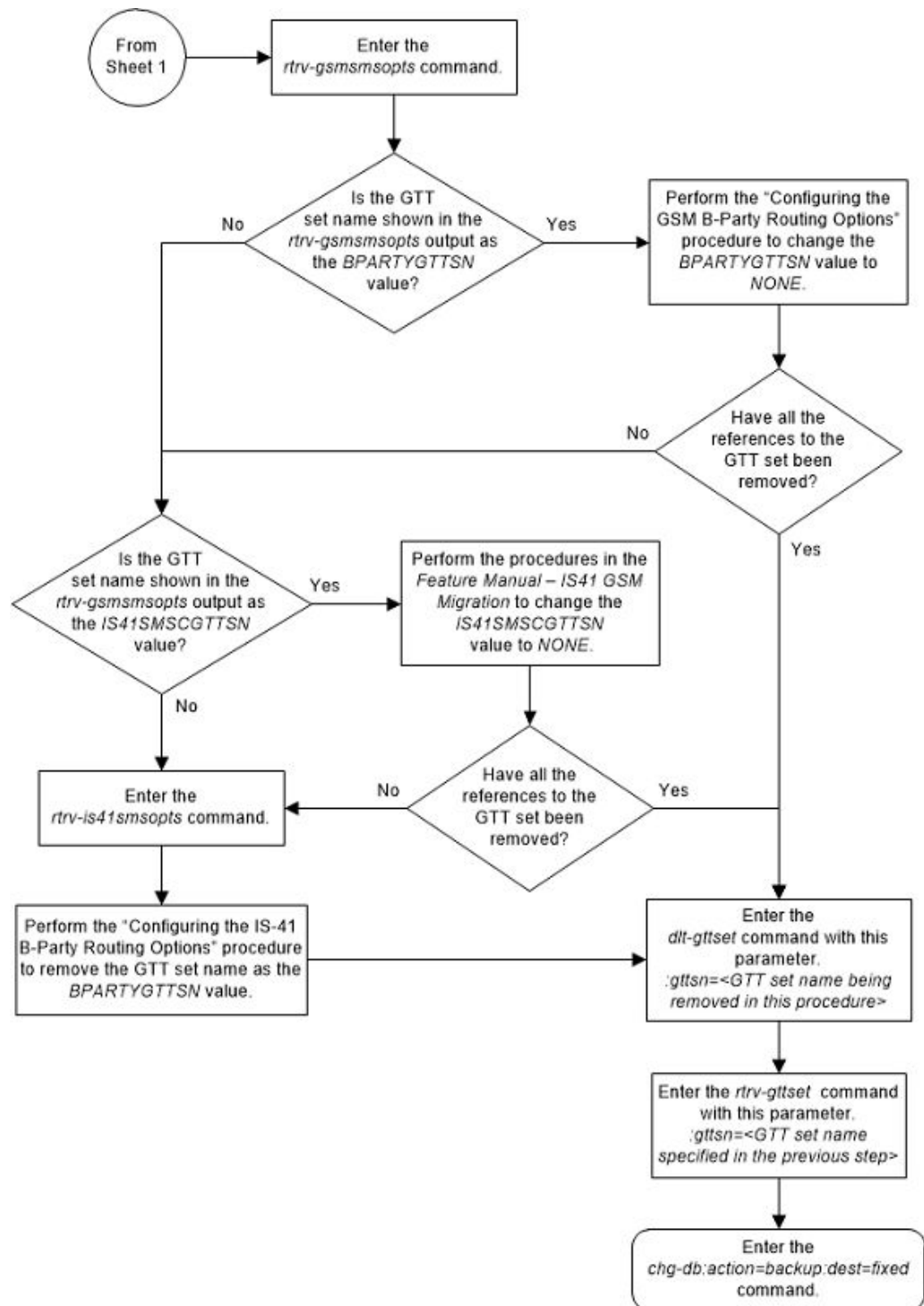

Figure 4-4 Remove a GTT Set - Sheet 2 of 2



Changing a GTT Set

Use this procedure to change the number of digits assigned to a global title translation (GTT) set, change the network domain of the GTT set to CROSS, or change the GTT set name using the `chg-gttset` command.

The `chg-gttset` command uses these parameters:

`:gttsn` – The GTT set name. The GTT set name (`gttsn`) specifies the GTT set being changed and must be shown in the `rtrv-gttset` output.

`:ngttsn` – The new GTT set name consisting of one alphabetic character and up to eight alphanumeric characters.

`:netdom=cross` – The CROSS network domain of the global title translation set. The network domain CROSS can be specified only if the ANSI/ITU SCCP Conversion feature, part number 893012001, is enabled, and if the GTT set is a CDGTA GTT set. If the `SETTYPE` column is not shown in the `rtrv-gttset` output, all the GTT sets are CDGTA GTT sets. The CROSS GTT set can be assigned to either an ANSI or ITU GTT selector. For more information, refer to the [ANSI/ITU SCCP Conversion Feature](#) section.

`:gttsetmeasrqd` - GTTSET Measurement required. This parameter specifies whether to perform per GTTSET measurements.

`:ndgt` – The number of digits contained in the global title translation. The `ndgt` parameter cannot be specified:

- If the Origin-Based SCCP Routing feature is enabled, the `SETTYPE` value of the GTT set is `CGSSN`, `CGPC`, or `OPC`.
- If the Flexible Linkset Optional Based Routing feature is enabled and turned on, the `SETTYPE` value of the GTT set is `CDSN` or `DPC`.
- If the TCAP Opcode Based Routing feature is enabled and turned on, the `SETTYPE` value of the GTT set is `OPCODE`.
- If GTAs are assigned to the GTT set. This can be verified with the `rtrv-gta` command and the GTT set name being changed in this procedure.
- If the VGTT feature is on, shown by the entry `VGTT = on` in the `rtrv-feat` command output. The length of the global title address is determined when the global title address is entered with the `ent-gta` command. For more information on the VGTT feature and the length of global title addresses, see the [Variable-length Global Title Translation Feature](#) section and the [Adding Global Title Address Information](#) procedure.

If the Variable-length Global Title Translation Feature (VGTT) is on, the `NDGT` field of the `rtrv-gttset` command shows the different lengths of global title addresses assigned to a GTT set name, as shown in the following example.

```
rlghncxa03w 09-07-07 00:30:31 GMT EAGLE5 41.1.0
```

GTTSN	NETDOM	NDGT
lidb	ansi	3, 7, 10
t800	ansi	6
si000	itu	15

```

imsi      itu      15
abcd1234  itu      12

```

GTT-SET table is (5 of 2000) 1% full.

In this example of the `rtrv-gttset` command output, the GTT set `lidb` contains three different length global title addresses; global title addresses containing three digits, seven digits, and 10 digits.

Caution:

If the VGTT feature is on and the ANSI/ITU SCCP Conversion feature is not enabled, this procedure cannot be performed.

`:sxudt` - Segmented XUDT. This parameter specifies whether TOBR will support the processing of segmented XUDT message.

Note:

The SXUDT parameter must be specified with the OPCODE GTT set type only.

1. Display the existing GTT sets in the database by entering the `rtrv-gttset` command.

This is an example of the possible output.

```
rlghncxa03w 10-07-07 00:27:31 GMT EAGLE5 42.0.0
```

GTTSN	NETDOM	SETTYPE	NDGT
abcd1234	itu	CDGTA	12
dpcl	itu	DPC	-
gttset1	ansi	CDGTA	6
gttset2	ansi	CGGTA	10
gttset3	ansi	OPC	-
gttset4	ansi	CGPC	-
gttset5	itu	CGPC	-
imsi	ansi	CDGTA	15
lidb	ansi	CDGTA	10
si000	itu	CDGTA	15
t800	ansi	CDGTA	10
gttset6	ansi	CDSSN	-
gttset7	itu	OPCODE	-

GTT-SET table is (13 of 2000) 1% full.

If the `SETTYPE` column is not shown in the `rtrv-gttset` output, all the GTT sets are CDGTA GTT sets.

If the `SETTYPE` column is shown in the `rtrv-gttset` output, and the `SETTYPE` value for the GTT set is `CGPC`, `CGSSN`, `OPC`, `CDSSN`, `OPCODE`, `DPC`, only the name of the GTT set can be changed.

If any GTT sets contain multiple entries in the `NDGT` column, the `VGTT` feature is on. The `ndgt` parameter cannot be specified with the `chg-gttset` command. The `NETDOM` value can be changed to `CROSS` only for a `CDGTA` GTT set. The name of the GTT set can be changed for any type of GTT set. Continue the procedure by performing one of these steps.

- If you do not wish to change the `NETDOM` value to `CROSS` for a `CDGTA` GTT set, or if you wish to only change the name of any type of GTT set, continue the procedure with [5](#).
- If you wish to change the `NETDOM` value to `CROSS` for a `CDGTA` GTT set, continue this procedure by performing one of these steps.
 - If any `CDGTA` GTT sets contain the value `CROSS` in the `NETDOM` column, continue the procedure with [5](#).
 - If the value `CROSS` does not appear in the `NETDOM` column for all the `CDGTA` GTT sets, continue the procedure with [3](#).

If all the GTT sets contain only one entry in the `NDGT` column, continue the procedure with [2](#).

2. Verify whether or not either the `VGTT` feature is on by entering the `rtrv-feat` command.

The entry `VGTT = on` is shown if the `VGTT` feature is on.

 **Note:**

The `rtrv-feat` command output contains other fields that are not used by this procedure. If you wish to see all the fields displayed by the `rtrv-feat` command, see the `rtrv-feat` command description in the *Commands Manual*.

If the `VGTT` feature is on, the `ndgt` parameter cannot be specified with the `chg-gttset` command.

If the `VGTT` feature is off, the `ndgt` parameter value can be changed under these conditions.

- If the `SETTYPE` column is not shown in the `rtrv-gttset` output in [1](#).
- If the `SETTYPE` column is shown in the `rtrv-gttset` output and the `SETTYPE` value for the GTT set is `CDGTA` or `CGGTA`.

If the `NDGT` value cannot be changed or you do not wish to change the `NDGT` value, the only action that can be performed on a GTT set is to change the `NETDOM` value to `CROSS` for a `CDGTA` GTT set. If you do not wish to change the `NETDOM` value to `CROSS` for a `CDGTA` GTT set, this procedure cannot be performed. If you wish to change the `NETDOM` value to `CROSS` for a `CDGTA` GTT set, continue the procedure by performing one of these steps.

- If any `CDGTA` GTT sets contain the value `CROSS` in the `NETDOM` column, continue the procedure by performing one of these steps.

- If the `ndgt` parameter value will be changed, continue the procedure with [4](#).
- If the `ndgt` parameter value will not be changed, continue the procedure with [5](#).
- If the value `CROSS` does not appear in the `NETDOM` column for all CDGTA GTT sets, continue the procedure with [3](#).

If you wish to change the `ndgt` parameter value and do not wish to change the `NETDOM` value to `CROSS`, continue the procedure with [4](#).

3. Display the status of the ANSI/ITU SCCP Conversion feature by entering this command.

```
rtrv-ctrl-feat:partnum=893012001
```

The following is an example of the possible output.

```
rlghncxa03w 07-05-28 21:15:37 GMT EAGLE5 37.0.0
The following features have been permanently enabled:
```

Feature Name	Partnum	Status	Quantity
SCCP Conversion	893012001	on	----

The following features have been temporarily enabled:

Feature Name	Partnum	Status	Quantity	Trial
Period Left				
Zero entries found.				

The following features have expired temporary keys:

Feature Name	Partnum
Zero entries found.	

If the ANSI/ITU SCCP Conversion feature is enabled, continue the procedure by performing one of these steps.

- If the `ndgt` parameter value will be changed, continue the procedure with [4](#).
- If the `ndgt` parameter value will not be changed, continue the procedure with [5](#).

If the ANSI/ITU SCCP Conversion feature is not enabled, the `netdom=cross` parameter cannot be specified with the `chg-gttset` command. If the ANSI/ITU SCCP Conversion feature is not enabled and the VGTT feature is on, this procedure cannot be performed.

If the ANSI/ITU SCCP Conversion feature is not enabled, perform the [Activating the ANSI/ITU SCCP Conversion Feature](#) procedure to enable the ANSI/ITU SCCP Conversion feature. After the ANSI/ITU SCCP Conversion is enabled, continue the procedure with [4](#).

4. Verify that no global title address information references the GTT set name being changed in this procedure.

Use the `rtrv-gta` command with the `gttsn` parameter specifying the GTT set name being removed from the database. If the `num` parameter is specified with the `rtrv-gta` command, and the value of the `num` parameter is greater than 1000,

the `force=yes` parameter must be specified with the `rtrv-gta` command. For this example, enter this command.

```
rtrv-gta:gttsn=imsi
```

This is an example of the possible output.

```
rlghncxa03w 10-07-07 00:28:31 GMT EAGLE5 42.0.0
GTTSN      NETDOM  SETTYPE  NDGT
imsi      ansi    CDGTA    10

GTA TABLE IS  1 % FULL (17 of 269999)

START GTA  END GTA   XLAT   RI    PC
8005550000 8005551999 dpcssn ssn    001-254-255
      SSN=255 CCGT=no CGGTMOD=NO
      GTMODID=----- TESTMODE=off
      OPTSN=----- CGSELID=----- OPCS=-----
      ACTSN=----- PPMEASREQD= NO
8005552000 8005553999 dpc    gt    001-254-255
      SSN=0   CCGT=no CGGTMOD=NO
      GTMODID=----- TESTMODE=off
      OPTSN=----- CGSELID=----- OPCS=-----
      ACTSN=----- PPMEASREQD= NO
8005554000 8005555999 dpcngt gt    001-254-255
      SSN=--- CCGT=no CGGTMOD=NO
      GTMODID=----- TESTMODE=off
      OPTSN=----- CGSELID=----- OPCS=gttset3
      ACTSN=----- PPMEASREQD= NO
8005556000 8005557999 dpcssn ssn    001-254-255
      SSN=255 CCGT=no CGGTMOD=NO
      GTMODID=----- TESTMODE=off
      OPTSN=----- CGSELID=----- OPCS=-----
      ACTSN=----- PPMEASREQD= NO
8005558000 8005559999 dpcssn ssn    001-254-255
      SSN=255 CCGT=yes CGGTMOD=NO
      GTMODID=----- TESTMODE=off
      OPTSN=----- CGSELID=----- OPCS=-----
      ACTSN=----- PPMEASREQD= NO
9195551212 9195551212 dpcssn ssn    008-001-001
      SSN=222 CCGT=no CGGTMOD=NO
      GTMODID=----- TESTMODE=off
      OPTSN=----- CGSELID=----- OPCS=-----
      ACTSN=----- PPMEASREQD= NO
9194600000 9194600000 dpc    gt    001-255-252
      SSN=0   CCGT=no CGGTMOD=NO
      GTMODID=----- TESTMODE=off
      OPTSN=----- CGSELID=----- OPCS=-----
      ACTSN=----- PPMEASREQD= NO
9194610000 9194680000 dpcssn ssn    001-255-252
      SSN=222 CCGT=no CGGTMOD=NO
      GTMODID=----- TESTMODE=off
      OPTSN=----- CGSELID=----- OPCS=-----
      ACTSN=----- PPMEASREQD= NO
9762428487 9762428487 dpcssn ssn    001-254-255
      SSN=222 CCGT=no CGGTMOD=NO
```

```

GTMODID=----- TESTMODE=off
OPTSN=----- CGSELID=----- OPCS=-----
ACTSN=----- PPMEASREQD= NO
9766423277 9766423277 dpcssn ssn 001-254-255
SSN=222 CCGT=no CGGTMOD=NO
GTMODID=----- TESTMODE=off
OPTSN=----- CGSELID=----- OPCS=-----
ACTSN=----- PPMEASREQD= NO
9769388928 9769388928 dpcssn ssn 001-254-255
SSN=222 CCGT=no CGGTMOD=NO
GTMODID=----- TESTMODE=off
OPTSN=----- CGSELID=----- OPCS=-----
ACTSN=----- PPMEASREQD= NO

```

Command Retrieved 11 Entries

If no global title address entries are shown in the `rtrv-gta` output, continue the procedure with [5](#).

If global title address entries are shown in the `rtrv-gta` output, perform [Removing Global Title Address Information](#) to remove any global title address entries that are shown in the `rtrv-gta` command output. After the global title address entries have been removed, continue the procedure with [5](#).

5. Change the GTT set using the `chg-gttset` command.

For this example, enter this command.

```
chg-gttset:gttsn=imsi:ndgt=10:netdom=cross
```

The `netdom=cross` parameter can be specified only if the ANSI/ITU SCCP Conversion feature is enabled. If the `SETTYPE` column is shown in the `rtrv-gttset` output, the `netdom=cross` parameter can be specified only for a CDGTA GTT set.

The `ndgt` parameter can be specified only if the VGTT feature is off. If the `SETTYPE` column is shown in the `rtrv-gttset` output, the `ndgt` parameter can be specified only for a CDGTA or CGGTA GTT set.

The `ngttsn` value cannot be none.

When this command has successfully completed, this message should appear.

```
rlghncxa03w 09-07-07 00:29:31 GMT EAGLE5 41.1.0
```

```
GTT-SET table is (12 of 2000) 1% full.
```

```
CHG-GTTSET: MASP A - COMPLTD
```

6. Verify the changes using the `rtrv-gttset` command with the `gttsn` parameter and value specified in [5](#).

For this example, enter this command.

```
rtrv-gttset:gttsn=imsi
```

The following is an example of the possible output.

```
rlghncxa03w 09-07-07 00:27:31 GMT EAGLE5 41.1.0
```

```
GTTSN      NETDOM  SETTYPE  NDGT
imsi       cross   CDGTA    10
```

```
GTT-SET table is (12 of 2000) 1% full.
```

7. Back up the new changes using the `chg-db:action=backup:dest=fixed` command.

These messages should appear, the active Maintenance and Administration Subsystem Processor (MASP) appears first.

```
BACKUP (FIXED) : MASP A - Backup starts on active MASP.
BACKUP (FIXED) : MASP A - Backup on active MASP to fixed disk
complete.
BACKUP (FIXED) : MASP A - Backup starts on standby MASP.
BACKUP (FIXED) : MASP A - Backup on standby MASP to fixed disk
complete.
```

Figure 4-5 Change a GTT Set - Sheet 1 of 3

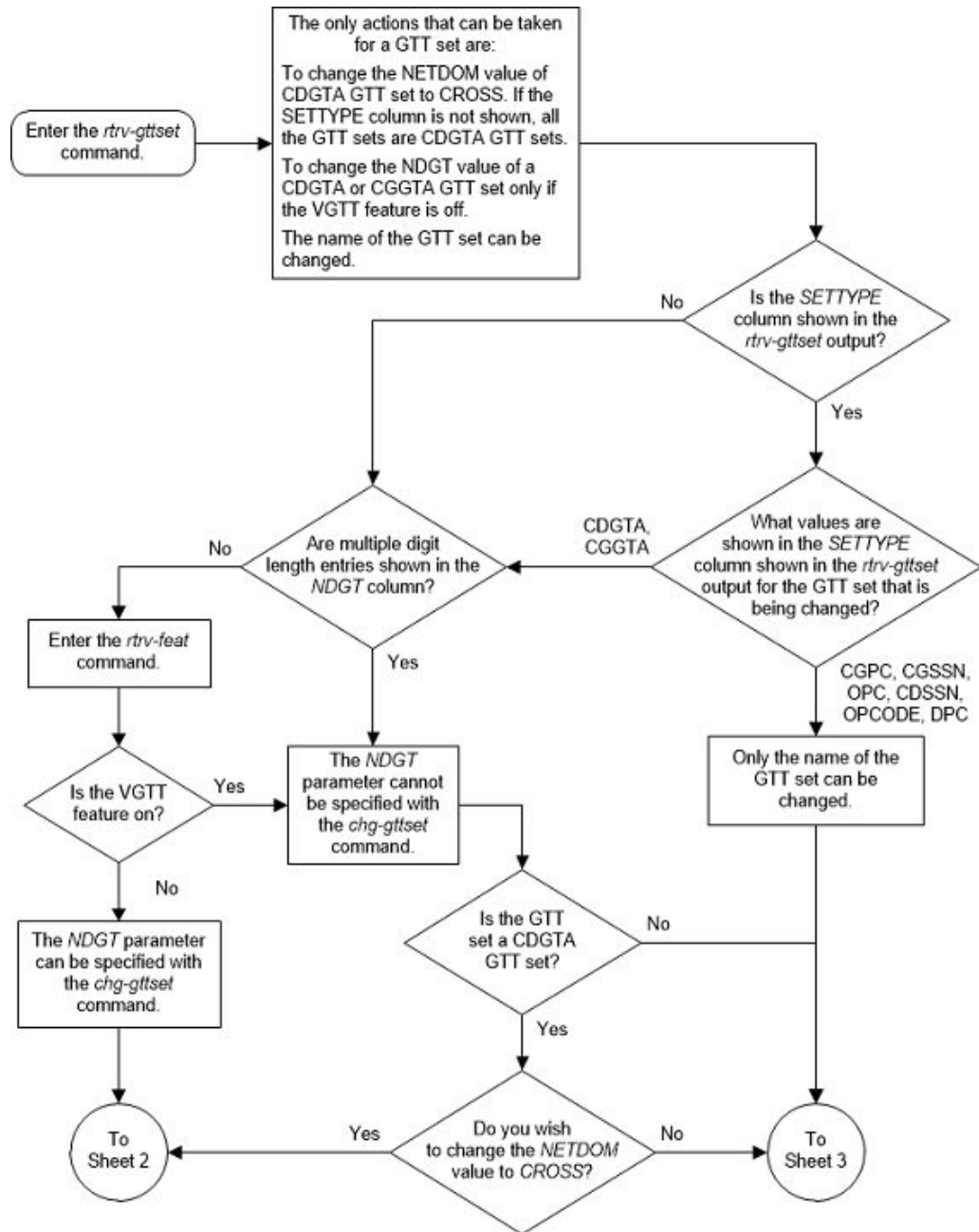

Figure 4-6 Change a GTT Set - Sheet 2 of 3

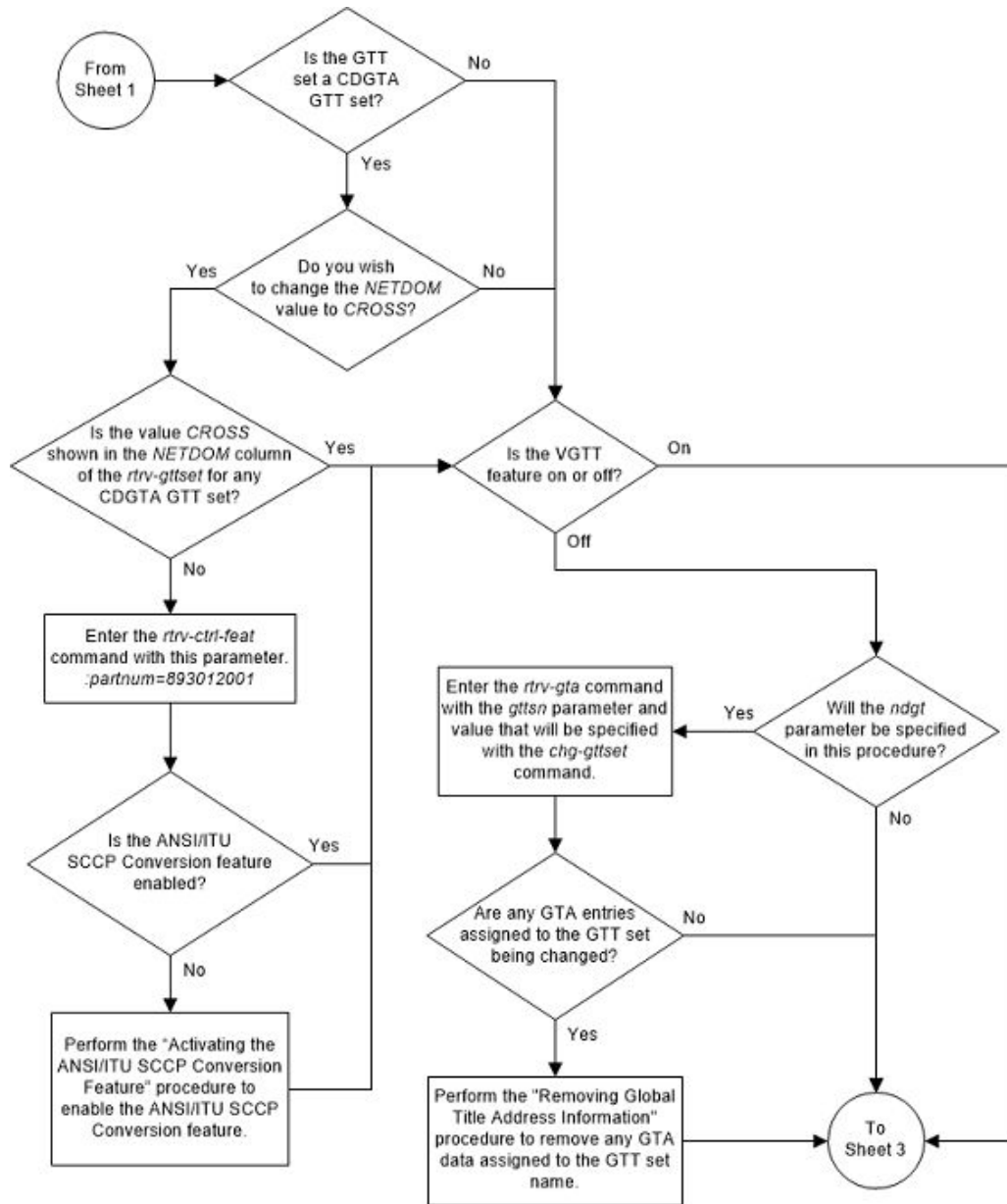
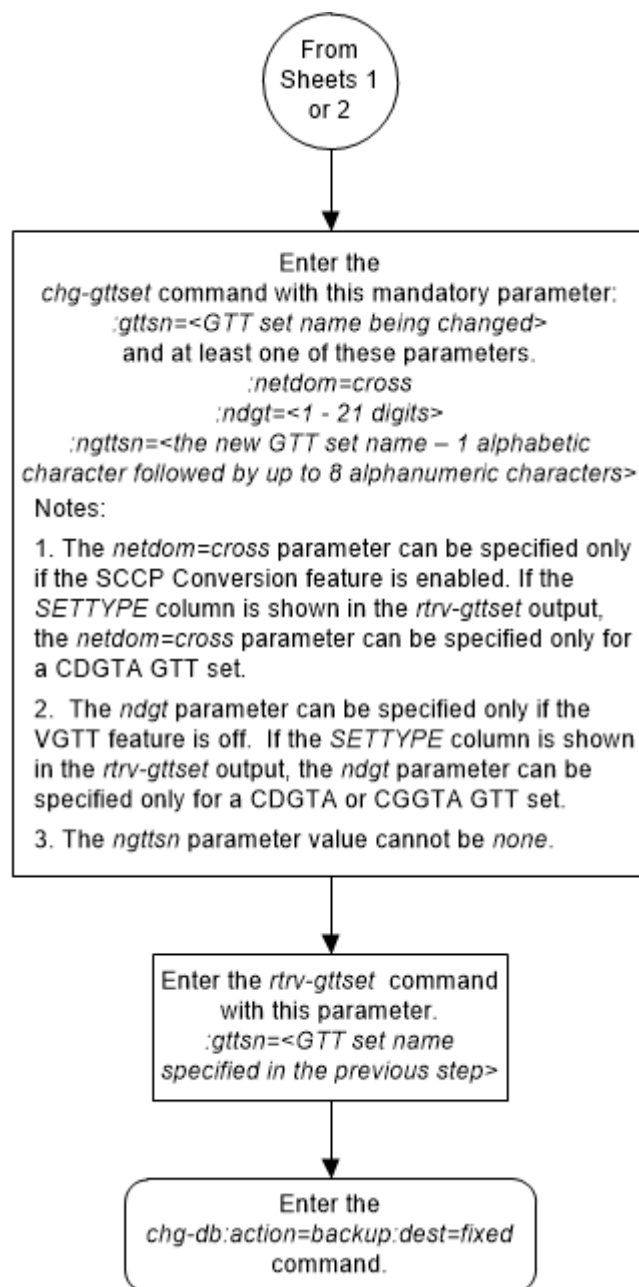

Figure 4-7 Change a GTT Set - Sheet 3 of 3



Adding a GTT Selector

Use the following procedure to specify the applicable GTT selectors for a global title entry using the *ent-gttset* command.

The *ent-gttset* command uses these parameters:

:gti/gtia/gtii/gtiis/gtin/gtins/gtin24 – The global title indicator. The GTI defines the domain as shown in this list.

- *gti* and *gtia* - ANSI global title indicator with the values 0 or 2

- `gtii` - ITU international (ITU-I) global title indicator with the values, 0, 2, or 4
- `gtiis` - ITU international (ITU-I) spare global title indicator with the values, 0, 2, or 4
- `gtin` - ITU national (ITU-N) global title indicator with the values 0, 2, or 4.
- `gtins` - ITU national (ITU-N) spare global title indicator with the values 0, 2, or 4.
- `gtin24` - ITU-N24 spare global title indicator with the values 0, 2, or 4.

`:tt` – The global title translation type, (0-255). The same translation type value can be specified for multiple GTI values. For example, the translation type value 10 can be assigned to an ANSI GTI, an ITU-I GTI, an ITU-I spare GTI, an ITU-N GTI, an ITU-N spare GTI, and an ITU-N24 GTI.

`:nai` – The nature of address indicator.

`:naiv` – The nature of address indicator value. (0-127) (Refer to [Table 4-6](#) for NAI/NAIV mapping)

 **Note:**

The nature of address indicator parameters (`naiv` or `nai`) can be specified by supplying either a mnemonic or an explicit value. At no time may both the mnemonic and the explicit value be specified at the same time for the same parameter. You can specify either the `naiv` or `nai` parameter. [Table 4-6](#) shows the mapping between the `naiv` and the `nai` parameters.

Table 4-6 NAI/NAI Mapping

NAIV	NAI	Description
0	---	Unknown
1	Sub	Subscriber Number
2	Rsvd	Reserved for national use
3	Natl	National significant number
4	Intl	International number
5-127	---	Spare

`:np` – The numbering plan.

`:npv` – The numbering plan value. (0-15) (Refer to [Table 4-7](#) for NP/NPV mapping)

 **Note:**

The numbering plan parameters (`npv` or `np`) can be specified by supplying either a mnemonic or an explicit value. At no time may both the mnemonic and the explicit value be specified at the same time for the same parameter. You can specify either the `npv` or `np` parameter. [Table 4-7](#) shows the mapping between the `npv` and the `np` parameters.

Table 4-7 NPV/NP Mapping

NPV	NP	Description
0	---	Unknown
1	E164	ISDN/telephony numbering plan
2	Generic	Generic numbering plan
3	X121	Data numbering plan
4	F69	Telex numbering plan
5	E210	Maritime mobile numbering plan
6	E212	Land mobile numbering plan
7	E214	ISDN/mobile numbering plan
8	Private	Private network or network-specific numbering plan
9-15	---	Spare

:gttsn – the GTT set name.

:cdgtasn – The CDGTA GTT set name.

:cggasn – The CGGTA GTT set name.

:cgpcsn – The CGPC GTT set name.

:cgssn – The CGPA SSN.

:selid – The selector ID.

:cdgttsn – The CDGTA GTT set name.

:cggtsn – The CGGTA GTT set name.

:eagle-gen – Indicates whether the GTT selector is used by messages generated by the EAGLE. If the GTT selector is used by messages generated by the EAGLE, the entry `Eagle-Gen` is shown in the `LSN` column of the `rtrv-gttset` output.

:lsn – The name of the linkset that is assigned to the GTT selector.

The Global Title Translation (GTT) feature and the Enhanced Global Title Translation (EGTT) features must be `on` before using this command. Use the `rtrv-feat` command to verify the settings. If the features are off, turn them on using the `chg-feat:gtt=on:egtt=on` command.

 **Note:**

Once the Global Title Translation (GTT) feature and the Enhanced Global Title Translation (EGTT) feature are turned on with the `chg-feat` command, they cannot be turned off.

The GTT feature and the EGTT feature must be purchased before you turn these features on. If you are not sure whether you have purchased the GTT feature and/or the EGTT feature, contact your Sales Representative or Account Representative.

The GTT selector table may not have more than 100,000 GTT selectors.

For the `gtii=4`, `gtin=4`, or `gtin24=4` parameter, the entry `dflt` may appear in the `rtrv-gttset` output. The value `dflt` cannot be specified as value for the `np` or `nai` parameters when you specify the `ent-gttset` command. If you enter a new GTT selector that matches an existing GTT selector's `gti` and `tt` and the existing selector has `dflt` as value for the `np` or `nai` parameters, a new entry is created with the new `np` or `nai` parameter values. The existing GTT selector entry with the `dflt` value is also retained. Use the `chg-gttset` or `dlt-gttset` commands to change or delete the `dflt` value. The parameter combination `npv/naiv` cannot be specified if `gtin=2` (or `gtin24=2`) or `gtii=2`. The `gtia=4` parameter is not supported.

These tables shows the parameter combinations and the rules for the parameters of the `ent-gttset` command.

- [Table 4-8](#)
- [Table 4-9](#)
- [Table 4-10](#)
- [Table 4-11](#)
- [Table 4-12](#)
- [Table 4-13](#)

1. Display the GTT selectors in the database by entering the `rtrv-gttset` command.

This is an example of the possible output.

```
rlghncxa03w 09-05-07 00:28:31 GMT EAGLE5 41.0.0
```

GTI	ANSI	TT	NP	CG	SSN	SELID	LSN	CDPA	CGPA
			NAI					GTTSET	GTTSET
2	75	--	---	---	55		any	lidb	(cdgta)
			(---)					
2	100	--	---	---	56		any	t800	(cdgta)
			(---)					
2	150	--	---	---	57		any	lidb	(cdgta)
			(---)					

GTI	INTL	TT	NP	CG	SSN	SELID	LSN	CDPA	CGPA
			NAI					GTTSET	GTTSET
2	0	--	---	---	none		any	s1000	(cdgta)

```

----- (--- )
2 87 -- --- --- none any imsi (cdgta)
----- (--- )
2 100 -- --- --- none any imsi (cdgta)
----- (--- )
4 0 dflt dflt --- none any s1000 (cdgta)
----- (--- )
4 0 e164 intl --- none any ----- (--- )
s2000 (cggta)
4 97 e210 5 100 100 any abcd1234 (cdgta)
----- (--- )
4 101 e210 5 101 101 lsn1l imsi (cdgta)
----- (--- )
4 150 e210 5 --- none Eagle-Gen abcd1234 (cdgta)
----- (--- )
4 219 e210 11 20 20 any gttset9 (cdgta)
----- (--- )
4 219 e210 11 21 20 any gttset9 (cdgta)
----- (--- )
4 219 e210 11 21 22 any gttset9 (cdgta)
----- (--- )
4 219 e210 11 23 22 any gttset9 (cdgta)
----- (--- )
4 219 e210 11 23 24 any gttset9 (cdgta)
----- (--- )
4 219 e210 11 23 25 any gttset9 (cdgta)
----- (--- )
4 219 e210 11 26 25 any gttset9 (cdgta)
----- (--- )

```

```

GTI          CG          CDPA          CGPA
NATL TT NP    NAI  SSN SELID LSN    GTTSET      GTTSET

```

```

GTI          CG          CDPA          CGPA
N24 TT NP    NAI  SSN SELID LSN    GTTSET      GTTSET

```

if the desired GTT set for the new GTT selector is shown in the `rtrv-gttset` output, continue the procedure by performing one of these steps.

- If the `GTTSN` column is shown in the `rtrv-gttset` output, only the EGTT feature is turned on. Continue the procedure by performing one of these steps.
 - If the new GTT selector will be provisioned for these features, perform these procedures to verify the status of these features and to enable, and turn on these features.
 - * [Origin-Based SCCP Routing - Activating the Origin-Based SCCP Routing Feature](#)
 - * [Flexible Linkset Optional Based Routing - Activating the Flexible Linkset Optional Based Routing Feature](#)
 - * [TCAP Opcode Based Routing - Activating the TCAP Opcode Based Routing Feature](#)

After the applicable features have been verified, and enabled and turned on if required, continue the procedure by performing one of these steps.

- * If the `lsn` parameter will not be specified for the GTT selector, continue the procedure with 5.
- * If the `lsn` parameter will be specified for the GTT selector, continue the procedure by performing one of these steps.
 - * If the name of the linkset that you wish to assign to the GTT selector is shown in the `rtrv-gttset` output in 1, continue the procedure with 5.
 - * If the name of the linkset that you wish to assign to the GTT selector is not shown in the `rtrv-gttset` output in 1, continue the procedure with 4.
- If the new GTT selector will be provisioned for only the EGTT feature, continue the procedure with 5.
- If the `CDPA GTTSET` and `CGPA GTTSET` columns are shown in the `rtrv-gttset` output, continue the with 3.

if the desired GTT set for the new GTT selector is not shown in the `rtrv-gttset` output, continue the procedure with 2.

2. Display the GTT sets in the database using the `rtrv-gttset` command. This is an example of the possible output.

```
rlghncxa03w 09-07-07 00:29:31 GMT EAGLE5 41.1.0
```

GTTSN	NETDOM	SETTYPE	NDGT
abcd1234	itu	CGGTA	12
imsi	itu	CDGTA	15
lidb	ansi	CDGTA	10
t800	ansi	CGGTA	6
s1000	itu	CDGTA	15
s2000	itu	CGPC	-

```
GTT-SET table is (6 of 2000) 1% full.
```

If the desired GTT set name is not shown in the `rtrv-gttset` output, perform [Adding a GTT Set](#) to add the required GTT set.

After the GTT set has been added, or if the desired GTT set name is shown in the `rtrv-gttset` output, continue the procedure by performing one of these steps.

- If the `GTTSN` column is shown in the `rtrv-gttset` output in 1, only the EGTT feature is turned on. Continue the procedure by performing one of these steps.
 - If the new GTT selector will be provisioned for these features, perform these procedures to verify the status of these features and to enable, and turn on these features.
 - * Origin-Based SCCP Routing - [Activating the Origin-Based SCCP Routing Feature](#)
 - * Flexible Linkset Optional Based Routing - [Activating the Flexible Linkset Optional Based Routing Feature](#)

- * TCAP Opcode Based Routing - [Activating the TCAP Opcode Based Routing Feature](#)
After the applicable features have been verified, and enabled and turned on if required, continue the procedure by performing one of these steps.
 - * If the `lsn` parameter will not be specified for the GTT selector, continue the procedure with 5.
 - * If the `lsn` parameter will be specified for the GTT selector, continue the procedure by performing one of these steps.
 - * If the name of the linkset that you wish to assign to the GTT selector is shown in the `rtrv-gttset` output in 1, continue the procedure with 5.
 - * If the name of the linkset that you wish to assign to the GTT selector is not shown in the `rtrv-gttset` output in 1, continue the procedure with 4.
 - If the new GTT selector will be provisioned for only the EGTT feature, continue the procedure with 5.
 - If the `CDPA GTTSET` and `CGPA GTTSET` columns are shown in the `rtrv-gttset` output, continue the with 3.
3. Display the features that are enabled, and turned on if necessary, by entering the `rtrv-ctrl-feat` command. This is an example of the possible output.

```
rlghncxa03w 09-05-07 00:29:31 GMT EAGLE5 41.0.0
The following features have been permanently enabled:
```

Feature Name	Partnum	Status	Quantity
SCCP Loop Detection	893016501	on	----
SCCP Conversion	893012001	off	----
HC-MIM SLK Capacity	893012707	on	64
Origin Based SCCP Routing	893014301	on	----
TCAP Opcode Based Routing	893027801	on	----
Flex Lset Optnl Based Rtg	893027701	on	----
VGTT with 16 GTT lengths	893024801	on	----
TOBR Opcode Quantity	893027907	on	1000000

```
The following features have been temporarily enabled:
```

Feature Name	Partnum	Status	Quantity	Trial Period
Left				

Zero entries found.

```
The following features have expired temporary keys:
```

Feature Name	Partnum
Zero entries found.	

If you wish to provision the GTT selector according for these features and any of these features are not enabled, or turned on if required, perform these procedures as needed to enable, and turn on these features.

- Origin-Based SCCP Routing - [Activating the Origin-Based SCCP Routing Feature](#)
- Flexible Linkset Optional Based Routing - [Activating the Flexible Linkset Optional Based Routing Feature](#)
- TCAP Opcode Based Routing - [Activating the TCAP Opcode Based Routing Feature](#)

After the features have been enabled, and turned on if necessary, or if you wish to provision the GTT selector according to the features that are enabled, and turned on, continue the procedure by performing one of these steps.

- If the `lsn` parameter will not be specified for the GTT selector, continue the procedure with [5](#).
 - If the `lsn` parameter will be specified for the GTT selector, continue the procedure by performing one of these steps.
 - If the name of the linkset that you wish to assign to the GTT selector is shown in the `rtrv-gttsel` output in [1](#), continue the procedure with [5](#).
 - If the name of the linkset that you wish to assign to the GTT selector is not shown in the `rtrv-gttsel` output in [1](#), continue the procedure with [4](#).
4. Display the linksets in the database by entering the `rtrv-ls` command. This is an example of the possible output.

```
rlghncxa03w 09-05-07 00:29:31 GMT EAGLE5 41.0.0
```

```

LSN          APCA   (SS7)   L3T SLT          GWS GWS GWS
SCRN SET SET BEI LST LNKS ACT MES DIS
SLSCI NIS
lsn1         001-001-002   none 1  1  no  A  3  off off off
no  off

```

```

LSN          APCI   (SS7)   L3T SLT          GWS GWS GWS
SCRN SET SET BEI LST LNKS ACT MES DIS
SLSCI NIS
lsni1        2-002-2     none 1  2  no  A  3  off off off
no  off
lsni2        2-002-3     none 1  2  no  A  4  off off off
no  off

```

```

LSN          APCN   (SS7)   L3T SLT          GWS GWS GWS
SCRN SET SET BEI LST LNKS ACT MES DIS
SLSCI NIS
lsnn1        00002     none 1  2  no  A  2  off off off
no  off
lsnn2        00003     none 1  2  no  A  1  off off off
no  off

```

```
Link set table is (5 of 1024) 1% full.
```

If the linkset that you wish to assign to the GTT selector is not shown in the `rtrv-ls` output, perform the "Adding an SS7 Linkset" procedure in *Database Administration - SS7 User's Guide* to add the linkset.

After the linkset has been added, or if the linkset that you wish to assign to the GTT selector is shown in the `rtrv-ls` output, continue the procedure with 5.

5. Add the GTT selector to the database with the `ent-gttset` command.

These tables shows the parameter combinations and the rules for the parameters of the `ent-gttset` command.

- [Table 4-8](#)
- [Table 4-9](#)
- [Table 4-10](#)
- [Table 4-11](#)
- [Table 4-12](#)
- [Table 4-13](#)

Table 4-8 Add GTT Selector Parameter Combinations - EGTT Only

Mandatory Parameters		
GTI/GTIA/GTII/ GTIIS/GTIN/GTINS/ GTIN24 = 0 (See Note 3)	GTI/GTIA/GTII/ GTIIS/GTIN/GTINS/ GTIN24 = 2 (See Note 3)	GTII/GTIIS/GTIN/GTINS/ GTIN24 = 4 (See Note 3)
GTTSN = <the GTT set name, from other GTT selectors or the <code>rtrv-gttset</code> output> (See Note 3)	TT = < the translation type - 0 to 255>	TT = < translation type - 0 to 255>
	GTTSN = <the GTT set name, from other GTT selectors or the <code>rtrv-gttset</code> output> (See Note 3)	GTTSN = <the GTT set name, from other GTT selectors or the <code>rtrv-gttset</code> output> (See Note 3)
		NP = <numbering plan> (See Notes 1 and 2) or NPV = <numbering plan value> (See Notes 1 and 2)
		NAI = <nature of address indicator> (See Notes 1 and 2) or NAIV = <nature of address indicator value> (See Notes 1 and 2)
Optional Parameter		
SELID = <SELID value - 0 to 65534>	SELID = <SELID value - 0 to 65534>	SELID = <SELID value - 0 to 65534>

Table 4-8 (Cont.) Add GTT Selector Parameter Combinations - EGTT Only

Notes:

1. Refer to [Table 4-18](#) for the `nai` and `naiv` parameter values. Refer to [Table 4-19](#) for the `np` and `npv` parameter values.
 - The value `dflt` cannot be specified for the `np/npv` or `nai/naiv` parameters.
 - Each translation type (TT) and NP (NPV) combination can have a maximum of five different NAI (NAIV) assigned to it.
2. These combinations of the `np`, `npv`, `nai`, and `naiv` parameters can be specified together in the `ent-gttset` command.
 - `np - nai`
 - `np - naiv`
 - `npv - nai`
 - `npv - naiv`
3. If the `gti/gtia` parameter is specified, the domain of the new GTT set must be ANSI. If the `gtii/gtin/gtiis/gtins/gtin24` parameter is specified, the domain of the new GTT set must be ITU. The domain of the GTT set can be CROSS, regardless of the value of the `gti` parameter.

Table 4-9 Add GTT Selector Parameter Combinations - Origin-Based SCCP Routing Enabled Only

Mandatory Parameters		
GTI/GTIA/GTII/ GTIIS/GTIN/GTINS/ GTIN24 = 0 (See Note 3)	GTI/GTIA/GTII/ GTIIS/GTIN/GTINS/ GTIN24 = 2 (See Note 3)	GTII/GTIIS/GTIN/GTINS/ GTIN24 = 4 (See Note 3)
CDGTASN = <the CDGTA GTT set name>, from other GTT selectors or the <code>rtrv- gttset output</code> >(See Notes 1, 3, 4, 5, 6, and 8)	TT = <the translation type - 0 to 255>	TT = <translation type - 0 to 255>
CGGTASN = <the CGGTA GTT set name>, from other GTT selectors or the <code>rtrv- gttset output</code> > (See Notes 1, 3, 4, 5, 6, 7, and 8)	CDGTASN = <the CDGTA GTT set name>, from other GTT selectors or the <code>rtrv- gttset output</code> >(See Notes 1, 3, 4, 5, 6, and 8)	CDGTASN = <the CDGTA GTT set name>, from other GTT selectors or the <code>rtrv- gttset output</code> > (See Notes 1, 3, 4, 5, 6, and 8)
CGPCSN = <the CGPC GTT set name>, from other GTT selectors or the <code>rtrv- gttset output</code> > (See Notes 1, 3, 4, 5, 6, 7, and 8)	CGGTASN = <the CGGTA GTT set name>, from other GTT selectors or the <code>rtrv- gttset output</code> > (See Notes 1, 3, 4, 5, 6, 7, and 8)	CGGTASN = <the CGGTA GTT set name>, from other GTT selectors or the <code>rtrv- gttset output</code> > (See Notes 1, 3, 4, 5, 6, 7, and 8)
	CGPCSN = <the CGPC GTT set name>, from other GTT selectors or the <code>rtrv- gttset output</code> > (See Notes 1, 3, 4, 5, 6, 7, and 8)	CGPCSN = <the CGPC GTT set name>, from other GTT selectors or the <code>rtrv- gttset output</code> > (See Notes 1, 3, 4, 5, 6, 7, and 8)
		NP=<numbering plan> (See Notes 2 and 9) or NPV = <numbering plan value> (See Notes 2 and 9)

**Table 4-9 (Cont.) Add GTT Selector Parameter Combinations - Origin-Based
SCCP Routing Enabled Only**

			NAI = <nature of address indicator> (See Notes 2 and 9) or
			NAIV = <nature of address indicator value> (See Notes 2 and 9)
Optional Parameters			
CGSSN = <CGSSN value - 0 to 255> (See Notes 5 and 7)	CGSSN = <CGSSN value - 0 to 255> (See Notes 5 and 7)	CGSSN = <CGSSN value - 0 to 255> (See Notes 5 and 7)	
SELID = <SELID value - 0 to 65534> (See Notes 5 and 7)	SELID = <SELID value - 0 to 65534> (See Notes 5 and 7)	SELID = <SELID value - 0 to 65534> (See Notes 5 and 7)	

Table 4-9 (Cont.) Add GTT Selector Parameter Combinations - Origin-Based SSCP Routing Enabled Only**Notes:**

1. CDGTA GTT sets are shown in the `CDPA GTTSET` column of the `rtrv-gttset` output. CGGTA and CGPC GTT sets are shown in the `CGPA GTTSET` column of the `rtrv-gttset` output.
2. Refer to [Table 4-18](#) for the `nai` and `naiv` parameter values. Refer to [Table 4-19](#) for the `np` and `npv` parameter values.
 - The value `dflt` cannot be specified for the `np/npv` or `nai/naiv` parameters.
 - Each translation type (TT) and NP (NPV) combination can have a maximum of five different NAI (NAIV) assigned to it. The TT, NP (NPV), and NAI, (NAIV) combination can have more than five entries as long as different CGSSN and SELID values are assigned to each entry.
3. If the `gti/gtia` parameter is specified, the domain of the new GTT set must be ANSI. If the `gtii/gtin/gtiis/gtins/gtin24` parameter is specified, the domain of the new GTT set must be ITU. The domain of the GTT set can be CROSS, regardless of the value of the `gti` parameter.
4. A GTT selector can contain the following combinations of GTT set name parameters.
 - CDGTASN only
 - CGGTASN only
 - CGPCSN only
 - CDGTASN and CGGTASN
 - CDGTASN and CGPCSN
5. If either the `cgssn` or `selid` parameters, or both parameters, are specified with the `ent-gttset` command, either the `cggtasn` or `cgpcsn` parameters must be specified with the `ent-gttset` command. The `cgssn` parameter cannot be specified with the `cdgtasn` parameter.
6. If a CGGTA or CGPC GTT set is specified for a selector that has a CDGTA GTT set assigned to it, the selector will have the CGGTA or CGPC GTT set and the CDGTA GTT set assigned to it.
7. Multiple entries can be assigned to a selector only if the `cggtasn` or `cgpcsn` parameters are specified for the selector. The `cgssn` and `selid` parameter values must be different for each entry that has the same `cggtasn` or `cgpcsn` parameter value. The first time a selector is added, the `cdgtasn` and either the `cggtasn` or `cgpcsn` parameters can be specified. If additional entries are added to the selector, only the `cggtasn` or `cgpcsn` parameters can be specified. All of these entries will contain the `cdgtasn` parameter value and either the `cggtasn` or `cgpcsn` parameter values.
8. If the selector contains multiple entries containing only the `cggtasn` or `cgpcsn` parameter values, and the `cdgtasn` parameter is specified for one of the entries of the selector, the `cdgtasn` parameter value is added to all the entries of the selector.
9. These combinations of the `np`, `npv`, `nai`, and `naiv` parameters can be specified together in the `ent-gttset` command.
 - `np - nai`
 - `np - naiv`
 - `npv - nai`
 - `npv - naiv`

Table 4-10 Add GTT Selector Parameter Combinations - Flexible Linkset Optional Based Routing Enabled and Turned On Only**Mandatory Parameters**

Table 4-10 (Cont.) Add GTT Selector Parameter Combinations - Flexible Linkset Optional Based Routing Enabled and Turned On Only

GTI/GTIA/GTII/ GTIIS/GTIN/GTINS/ GTIN24 = 0 (See Note 3) CDGTTSN = <the CDGTA GTT set name>, from other GTT selectors or the <code>rtrv- gttset</code> output> (See Notes 1, 3, 4, and 5) CGGTTSN = <the CDGTA GTT set name>, from other GTT selectors or the <code>rtrv- gttset</code> output> (See Notes 1, 3, 4, 5, and 7)	GTI/GTIA/GTII/ GTIIS/GTIN/GTINS/ GTIN24 = 2 (See Note 3) TT = <the translation type - 0 to 255> CDGTTSN = <the CDGTA GTT set name>, from other GTT selectors or the <code>rtrv- gttset</code> output> (See Notes 1, 3, 4, and 5) CGGTTSN = <the CDGTA GTT set name>, from other GTT selectors or the <code>rtrv- gttset</code> output> (See Notes 1, 3, 4, 5, and 7)	GTII/GTIIS/GTIN/GTINS/ GTIN24 = 4 (See Note 3) TT = <translation type - 0 to 255> CDGTTSN = <the CDGTA GTT set name>, from other GTT selectors or the <code>rtrv- gttset</code> output> (See Notes 1, 3, 4, and 5) CGGTTSN = <the CDGTA GTT set name>, from other GTT selectors or the <code>rtrv- gttset</code> output> (See Notes 1, 3, 4, 5, and 7) NP=<numbering plan> (See Notes 2 and 8) or NPV = <numbering plan value> (See Notes 2 and 8) NAI = <nature of address indicator> (See Notes 2 and 8) or NAIV = <nature of address indicator value> (See Notes 2 and 8)
Optional Parameters		
SELID = <SELID value - 0 to 65534> (See Notes 4 and 7) LSN = The name of the linkset from other GTT selectors or the <code>rtrv-ls</code> output> (See Notes 4, 6, and 7)	SELID = <SELID value - 0 to 65534> (See Notes 4 and 7) LSN = The name of the linkset from other GTT selectors or the <code>rtrv-ls</code> output> (See Notes 4, 6, and 7) EAGLEGEN=YES (See Note 7)	SELID = <SELID value - 0 to 65534> (See Notes 4 and 7) LSN = The name of the linkset from other GTT selectors or the <code>rtrv-ls</code> output> (See Notes 4, 6, and 7) EAGLEGEN=YES (See Note 7)

Table 4-10 (Cont.) Add GTT Selector Parameter Combinations - Flexible Linkset Optional Based Routing Enabled and Turned On Only

Notes:

1. The SETTYPE column is not shown in the `rtrv-gttset` output, so all the GTT sets are CDGTA GTT sets.
2. Refer to [Table 4-18](#) for the `nai` and `naiv` parameter values. Refer to [Table 4-19](#) for the `np` and `npv` parameter values.
 - The value `dflt` cannot be specified for the `np/npv` or `nai/naiv` parameters.
 - Each translation type (TT) and NP (NPV) combination can have a maximum of five different NAI (NAIV) assigned to it. The TT, NP (NPV), and NAI, (NAIV) combination can have more than five entries as long as different CGSSN and SELID values are assigned to each entry.
3. If the `gti/gtia` parameter is specified, the domain of the new GTT set must be ANSI. If the `gtii/gtin/gtiis/gtins/gtin24` parameter is specified, the domain of the new GTT set must be ITU. The domain of the GTT set can be CROSS, regardless of the value of the `gti` parameter.
4. Multiple entries can be assigned to a selector only if the `selid` or `lsn` parameter values are different for each entry.
5. If the GTT selector contains one GTT set, another GTT set can be added to the GTT selector. If the GTT selector contains an entry in the `CDPA GTTSET` column, the other GTT set is added by specifying the `cggtsn` parameter. If the GTT selector contains an entry in the `CGPA GTTSET` column, the other GTT set is added by specifying the `cdgtsn` parameter.
6. The domain of the linkset, ANSI, ITU-I, ITU-N, or ITU-N24, must be the same as the domain of the `gtii/gtin/gtiis/gtins/gtin24` parameter.
7. If the `eaglegen=yes` parameter is specified for the GTT selector, the `cggtsn`, `selid`, and `lsn` parameters cannot be specified for the GTT selector.
8. These combinations of the `np`, `npv`, `nai`, and `naiv` parameters can be specified together in the `ent-gttset` command.
 - `np - nai`
 - `np - naiv`
 - `npv - nai`
 - `npv - naiv`

Table 4-11 Add GTT Selector Parameter Combinations - OBSR Enabled and FLOBR Enabled and Turned On

Mandatory Parameters		
GTI/GTIA/GTII/ GTIIS/GTIN/GTINS/ GTIN24 = 0 (See Note 3)	GTI/GTIA/GTII/ GTIIS/GTIN/GTINS/ GTIN24 = 2 (See Note 3)	GTII/GTIIS/GTIN/GTINS/ GTIN24 = 4 (See Note 3)
CDGTTSN = <the CDGTA GTT set name>, from other GTT selectors or the <code>rtrv- gttset</code> output> (See Notes 1, 3, 4, 5, and 8)	TT = <the translation type - 0 to 255>	TT = <translation type - 0 to 255>
CGGTTSN = <the CDGTA GTT set name>, from other GTT selectors or the <code>rtrv- gttset</code> output> (See Notes 1, 3, 4, 5, 7, and 8)	CDGTTSN = <the CDGTA GTT set name>, from other GTT selectors or the <code>rtrv- gttset</code> output> (See Notes 1, 3, 4, 5, and 8)	CDGTTSN = <the CDGTA GTT set name>, from other GTT selectors or the <code>rtrv- gttset</code> output> (See Notes 1, 3, 4, 5, and 8)

Table 4-11 (Cont.) Add GTT Selector Parameter Combinations - OBSR Enabled and FLOBR Enabled and Turned On

	CGGTTSN = <the CDGTA GTT set name>, from other GTT selectors or the <code>rtrv-gttset</code> output> (See Notes 1, 3, 4, 5, 7, and 8)	CGGTTSN = <the CDGTA GTT set name>, from other GTT selectors or the <code>rtrv-gttset</code> output> (See Notes 1, 3, 4, 5, 7, and 8)
		NP=<numbering plan> (See Notes 2 and 9) or NPV = <numbering plan value> (See Notes 2 and 9)
		NAI = <nature of address indicator> (See Notes 2 and 9) or NAIV = <nature of address indicator value> (See Notes 2 and 9)
Optional Parameters		
SELID = <SELID value - 0 to 65534> (See Notes 4 and 7)	SELID = <SELID value - 0 to 65534> (See Notes 4 and 7)	SELID = <SELID value - 0 to 65534> (See Notes 4 and 7)
CGSSN = <CGSSN value - 0 to 255> (See Notes 7 and 8)	CGSSN = <CGSSN value - 0 to 255> (See Notes 7 and 8)	CGSSN = <CGSSN value - 0 to 255> (See Notes 7 and 8)
LSN = The name of the linkset from other GTT selectors or the <code>rtrv-ls</code> output> (See Notes 4, 6, and 7)	LSN = The name of the linkset from other GTT selectors or the <code>rtrv-ls</code> output> (See Notes 4, 6, and 7)	LSN = The name of the linkset from other GTT selectors or the <code>rtrv-ls</code> output> (See Notes 4, 6, and 7)
	EAGLEGEN=YES (See Note 7)	EAGLEGEN=YES (See Note 7)
OBSR - the Origin-Based SCCP Routing feature		
FLOBR - the Flexible Linkset Optional Based Routing feature		

Table 4-11 (Cont.) Add GTT Selector Parameter Combinations - OBSR Enabled and FLOBR Enabled and Turned On**Notes:**

1. The `SETTYPE` column is shown in the `rtrv-gttset` output. These GTT sets can be provisioned in the database and assigned to a GTT selector with either the `cdgttsn` or `cggtsn` parameters.
 - CDGTA GTT sets
 - CGGTA GTT sets
 - CGPC GTT sets
 - CGSSN GTT sets
 - OPC GTT sets
 - CDSSN GTT sets
 - DPC GTT sets
2. Refer to [Table 4-18](#) for the `nai` and `naiv` parameter values. Refer to [Table 4-19](#) for the `np` and `npv` parameter values.
 - The value `dflt` cannot be specified for the `np/npv` or `nai/naiv` parameters.
 - Each translation type (TT) and NP (NPV) combination can have a maximum of five different NAI (NAIV) assigned to it. The TT, NP (NPV), and NAI, (NAIV) combination can have more than five entries as long as different CGSSN and SELID values are assigned to each entry.
3. If the `gti/gtia` parameter is specified, the domain of the new GTT set must be ANSI. If the `gtii/gtin/gtiis/gtins/gtin24` parameter is specified, the domain of the new GTT set must be ITU. The domain of the GTT set can be CROSS, regardless of the value of the `gti` parameter.
4. Multiple entries can be assigned to a selector only if the `selid` or `lsn` parameter values are different for each entry.
5. If the GTT selector contains one GTT set, another GTT set can be added to the GTT selector. If the GTT selector contains an entry in the `CDPA GTTSET` column, the other GTT set is added by specifying the `cggtsn` parameter. If the GTT selector contains an entry in the `CGPA GTTSET` column, the other GTT set is added by specifying the `cdgttsn` parameter. If the GTT selector contains an entry in the `CGPA GTTSET` column and the GTT selector contains a `cgssn` value, the `cdgttsn` parameter cannot be specified.
6. The domain of the linkset, ANSI, ITU-I, ITU-N, or ITU-N24, must be the same as the domain of the `gtii/gtin/gtiis/gtins/gtin24` parameter.
7. If the `eaglegen=yes` parameter is specified for the GTT selector, the `cggtsn`, `cgssn`, `selid`, and `lsn` parameters cannot be specified for the GTT selector.
8. The `cgssn` parameter can be specified only if the `cggtsn` parameter is specified and without the `cdgttsn` parameter.
9. These combinations of the `np`, `npv`, `nai`, and `naiv` parameters can be specified together in the `ent-gttset` command.
 - `np - nai`
 - `np - naiv`
 - `npv - nai`
 - `npv - naiv`

Table 4-12 Add GTT Selector Parameter Combinations - FLOBR and TOBR Enabled and Turned On Only**Mandatory Parameters**

Table 4-12 (Cont.) Add GTT Selector Parameter Combinations - FLOBR and TOBR Enabled and Turned On Only

GTI/GTIA/GTII/ GTIIS/GTIN/GTINS/ GTIN24 = 0 (See Note 3) CDGTTSN = <the GTT set name>, from other GTT selectors or the <code>rtrv- gttset</code> output> (See Notes 1, 3, 4, and 5) CGGTTSN = <the GTT set name>, from other GTT selectors or the <code>rtrv- gttset</code> output> (See Notes 1, 3, 4, 5, and 7)	GTI/GTIA/GTII/ GTIIS/GTIN/GTINS/ GTIN24 = 2 (See Note 3) TT = <the translation type - 0 to 255> CDGTTSN = <the GTT set name>, from other GTT selectors or the <code>rtrv- gttset</code> output> (See Notes 1, 3, 4, and 5) CGGTTSN = <the GTT set name>, from other GTT selectors or the <code>rtrv- gttset</code> output> (See Notes 1, 3, 4, 5, and 7)	GTII/GTIIS/GTIN/GTINS/ GTIN24 = 4 (See Note 3) TT = <translation type - 0 to 255> CDGTTSN = <the GTT set name>, from other GTT selectors or the <code>rtrv- gttset</code> output> (See Notes 1, 3, 4, and 5) CGGTTSN = <the GTT set name>, from other GTT selectors or the <code>rtrv- gttset</code> output> (See Notes 1, 3, 4, 5, and 7) NP=<numbering plan> (See Notes 2 and 8) or NPV = <numbering plan value> (See Notes 2 and 8) NAI = <nature of address indicator> (See Notes 2 and 8) or NAIV = <nature of address indicator value> (See Notes 2 and 8)
Optional Parameters		
SELID = <SELID value - 0 to 65534> (See Notes 4 and 7) LSN = The name of the linkset from other GTT selectors or the <code>rtrv-ls</code> output> (See Notes 4, 6, and 7)	SELID = <SELID value - 0 to 65534> (See Notes 4 and 7) LSN = The name of the linkset from other GTT selectors or the <code>rtrv-ls</code> output> (See Notes 4, 6, and 7) EAGLEGEN=YES (See Note 7)	SELID = <SELID value - 0 to 65534> (See Notes 4 and 7) LSN = The name of the linkset from other GTT selectors or the <code>rtrv-ls</code> output> (See Notes 4, 6, and 7) EAGLEGEN=YES (See Note 7)
FLOBR - the Flexible Linkset Optional Based Routing feature		
TOBR - the TCAP Opcode Based Routing feature		

Table 4-12 (Cont.) Add GTT Selector Parameter Combinations - FLOBR and TOBR Enabled and Turned On Only

Notes:

1. The `SETTYPE` column is shown in the `rtrv-gttset` output. These GTT sets can be provisioned in the database and assigned to a GTT selector with either the `cdgttsn` or `cggttsn` parameters.
 - CDGTA GTT sets
 - CDSSN GTT sets
 - DPC GTT sets
 - OPCODE GTT sets
2. Refer to [Table 4-18](#) for the `nai` and `naiv` parameter values. Refer to [Table 4-19](#) for the `np` and `npv` parameter values.
 - The value `dflt` cannot be specified for the `np/npv` or `nai/naiv` parameters.
 - Each translation type (TT) and NP (NPV) combination can have a maximum of five different NAI (NAIV) assigned to it. The TT, NP (NPV), and NAI, (NAIV) combination can have more than five entries as long as different CGSSN and SELID values are assigned to each entry.
3. If the `gti/gtia` parameter is specified, the domain of the new GTT set must be ANSI. If the `gtii/gtin/gtiis/gtins/gtin24` parameter is specified, the domain of the new GTT set must be ITU. The domain of the GTT set can be CROSS, regardless of the value of the `gti` parameter.
4. Multiple entries can be assigned to a selector only if the `selid` or `lsn` parameter values are different for each entry.
5. If the GTT selector contains one GTT set, another GTT set can be added to the GTT selector. If the GTT selector contains an entry in the `CDPA GTTSET` column, the other GTT set is added by specifying the `cggttsn` parameter. If the GTT selector contains an entry in the `CGPA GTTSET` column, the other GTT set is added by specifying the `cdgttsn` parameter.
6. The domain of the linkset, ANSI, ITU-I, ITU-N, or ITU-N24, must be the same as the domain of the `gtii/gtin/gtiis/gtins/gtin24` parameter.
7. If the `eaglegen=yes` parameter is specified for the GTT selector, the `cggttsn`, `selid`, and `lsn` parameters cannot be specified for the GTT selector.
8. These combinations of the `np`, `npv`, `nai`, and `naiv` parameters can be specified together in the `ent-gttset` command.
 - `np - nai`
 - `np - naiv`
 - `npv - nai`
 - `npv - naiv`

Table 4-13 Add GTT Selector Parameter Combinations - OBSR Enabled, and FLOBR and TOBR Enabled and Turned On

Mandatory Parameters		
GTI/GTIA/GTII/ GTIIS/GTIN/GTINS/ GTIN24 = 0 (See Note 3)	GTI/GTIA/GTII/ GTIIS/GTIN/GTINS/ GTIN24 = 2 (See Note 3)	GTII/GTIIS/GTIN/GTINS/ GTIN24 = 4 (See Note 3)
CDGTTSN = <the GTT set name>, from other GTT selectors or the <code>rtrv-gttset</code> output> (See Notes 1, 3, 4, 5, and 8)	TT = <the translation type - 0 to 255>	TT = <translation type - 0 to 255>

Table 4-13 (Cont.) Add GTT Selector Parameter Combinations - OBSR Enabled, and FLOBR and TOBR Enabled and Turned On

CGGTTSN = <the GTT set name>, from other GTT selectors or the <code>rtrv-gttset</code> output> (See Notes 1, 3, 4, 5, 7, and 8)	CDGTTSN = <the GTT set name>, from other GTT selectors or the <code>rtrv-gttset</code> output> (See Notes 1, 3, 4, 5, and 8)	CDGTTSN = <the GTT set name>, from other GTT selectors or the <code>rtrv-gttset</code> output> (See Notes 1, 3, 4, 5, and 8)
	CGGTTSN = <the GTT set name>, from other GTT selectors or the <code>rtrv-gttset</code> output> (See Notes 1, 3, 4, 5, 7, and 8)	CGGTTSN = <the GTT set name>, from other GTT selectors or the <code>rtrv-gttset</code> output> (See Notes 1, 3, 4, 5, 7, and 8)
		NP=<numbering plan> (See Notes 2 and 9) or NPV = <numbering plan value> (See Notes 2 and 9)
		NAI = <nature of address indicator> (See Notes 2 and 9) or NAIV = <nature of address indicator value> (See Notes 2 and 9)
Optional Parameters		
SELID = <SELID value - 0 to 65534> (See Notes 4 and 7)	SELID = <SELID value - 0 to 65534> (See Notes 4 and 7)	SELID = <SELID value - 0 to 65534> (See Notes 4 and 7)
CGSSN = <CGSSN value - 0 to 255> (See Notes 7 and 8)	CGSSN = <CGSSN value - 0 to 255> (See Notes 7 and 8)	CGSSN = <CGSSN value - 0 to 255> (See Notes 7 and 8)
LSN = The name of the linkset from other GTT selectors or the <code>rtrv-ls</code> output> (See Notes 4, 6, and 7)	LSN = The name of the linkset from other GTT selectors or the <code>rtrv-ls</code> output> (See Notes 4, 6, and 7)	LSN = The name of the linkset from other GTT selectors or the <code>rtrv-ls</code> output> (See Notes 4, 6, and 7)
	EAGLEGEN=YES (See Note 7)	EAGLEGEN=YES (See Note 7)
OBSR - the Origin-Based SCCP Routing feature		
FLOBR - the Flexible Linkset Optional Based Routing feature		
TOBR - the TCAP Opcode Based Routing feature		

Table 4-13 (Cont.) Add GTT Selector Parameter Combinations - OBSR Enabled, and FLOBR and TOBR Enabled and Turned On**Notes:**

1. The `SETTYPE` column is shown in the `rtrv-gttset` output. These GTT sets can be provisioned in the database and assigned to a GTT selector with either the `cdgttsn` or `cggttsn` parameters.
 - CDGTA GTT sets
 - CGGTA GTT sets
 - CGPC GTT sets
 - CGSSN GTT sets
 - OPC GTT sets
 - CDSSN GTT sets
 - DPC GTT sets
 - OPCODE GTT sets
2. Refer to [Table 4-18](#) for the `nai` and `naiv` parameter values. Refer to [Table 4-19](#) for the `np` and `npv` parameter values.
 - The value `dflt` cannot be specified for the `np/npv` or `nai/naiv` parameters.
 - Each translation type (TT) and NP (NPV) combination can have a maximum of five different NAI (NAIV) assigned to it. The TT, NP (NPV), and NAI, (NAIV) combination can have more than five entries as long as different CGSSN and SELID values are assigned to each entry.
3. If the `gti/gtia` parameter is specified, the domain of the new GTT set must be ANSI. If the `gtii/gtin/gtiis/gtins/gtin24` parameter is specified, the domain of the new GTT set must be ITU. The domain of the GTT set can be CROSS, regardless of the value of the `gti` parameter.
4. Multiple entries can be assigned to a selector only if the `selid`, `lsn`, or `cgssn` parameter values are different for each entry.
5. If the GTT selector contains one GTT set, another GTT set can be added to the GTT selector. If the GTT selector contains an entry in the `CDPA GTTSET` column, the other GTT set is added by specifying the `cggttsn` parameter. If the GTT selector contains an entry in the `CGPA GTTSET` column, the other GTT set is added by specifying the `cdgttsn` parameter. If the GTT selector contains an entry in the `CGPA GTTSET` column and the GTT selector contains a `cgssn` value, the `cdgttsn` parameter cannot be specified.
6. The domain of the linkset, ANSI, ITU-I, ITU-N, or ITU-N24, must be the same as the domain of the `gtii/gtin/gtiis/gtins/gtin24` parameter.
7. If the `eaglegen=yes` parameter is specified for the GTT selector, the `cggttsn`, `selid`, `cgssn`, and `lsn` parameters cannot be specified for the GTT selector.
8. The `cgssn` parameter can be specified only if the `cggttsn` parameter is specified and without the `cdgttsn` parameter.
9. These combinations of the `np`, `npv`, `nai`, and `naiv` parameters can be specified together in the `ent-gttset` command.
 - `np - nai`
 - `np - naiv`
 - `npv - nai`
 - `npv - naiv`

For this example, enter these commands.

```
ent-
gttsel:gtii=4:tt=0:cdgttsn=cdggtt2:selid=50:lsn=lsni1:cggttsn=
opcode6 :np=e164:nai=intl
```

```
ent-
gtttsel:gtii=4:tt=0:selid=50:lsn=lsn11:cggttsn=cggtal0:np=e164
:nai=intl:cgssn=25
```

When these commands have successfully completed, this message appears.

```
rlghncxa03w 09-05-07 00:29:31 GMT EAGLE5 41.0.0
ENT-GTTSEL: MASP A   COMPLTD
```

- Verify the changes using the `rtrv-gttsel` command with the `gti`, `tt`, and either the `gttsn`, `cdgtasn`, `cggtasn`, `cgpcsn`, `cdgttsn`, or `cggttsn` parameters and values specified in 5.

For this example, enter these commands.

```
rtrv-gtttsel:gtii=4:tt=0:cdgttsn=cdggt2:cggttsn=opcode6
```

This is an example of the possible output.

```
rlghncxa03w 09-05-07 00:30:31 GMT EAGLE5 41.0.0

GTI          CG          CDPA          CGPA
INTL TT NP      NAI SSN SELID LSN      GTTSET      GTTSET
4    0  e164    intl any 50    lsn11      cdggt2      (cdgta)
opcode6      (opcde)
```

```
rtrv-gtttsel:gtii=4:tt=0:cggttsn=cggtal0
```

This is an example of the possible output.

```
rlghncxa03w 09-05-07 00:30:31 GMT EAGLE5 41.0.0

GTI          CG          CDPA          CGPA
INTL TT NP      NAI SSN SELID LSN      GTTSET      GTTSET
4    0  e164    intl 25 50    lsn11      -----      (--- )
cggtal0      (cggtal0)
```

- Backup the new changes using the `chg-db:action=backup:dest=fixed` command. These messages should appear, the active Maintenance and Administration Subsystem Processor (MASP) appears first.

```
BACKUP (FIXED) : MASP A - Backup starts on active MASP.
BACKUP (FIXED) : MASP A - Backup on active MASP to fixed disk
complete.
BACKUP (FIXED) : MASP A - Backup starts on standby MASP.
BACKUP (FIXED) : MASP A - Backup on standby MASP to fixed disk
complete.
```

Figure 4-8 Add a GTT Selector - Sheet 1 of 2

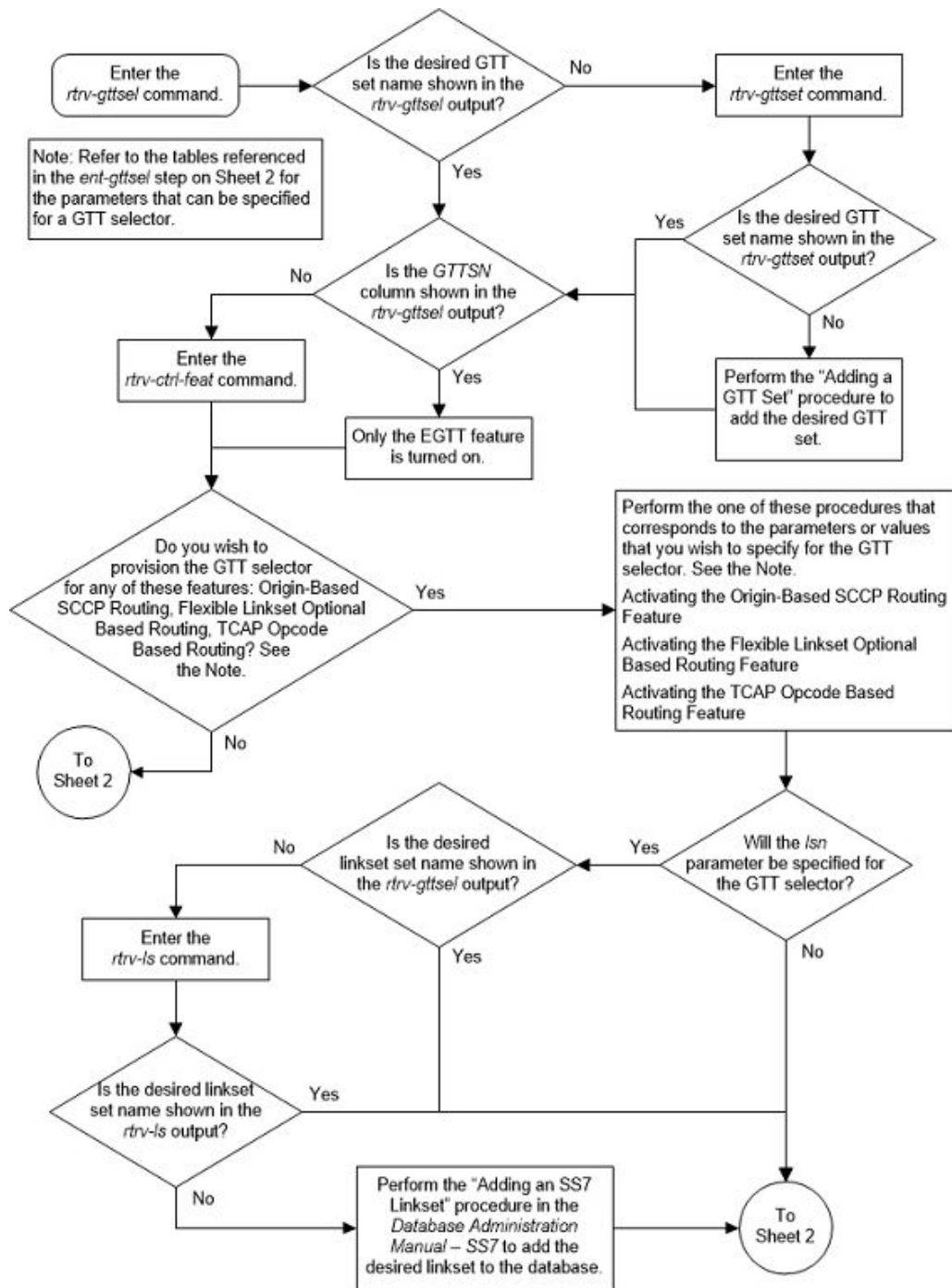
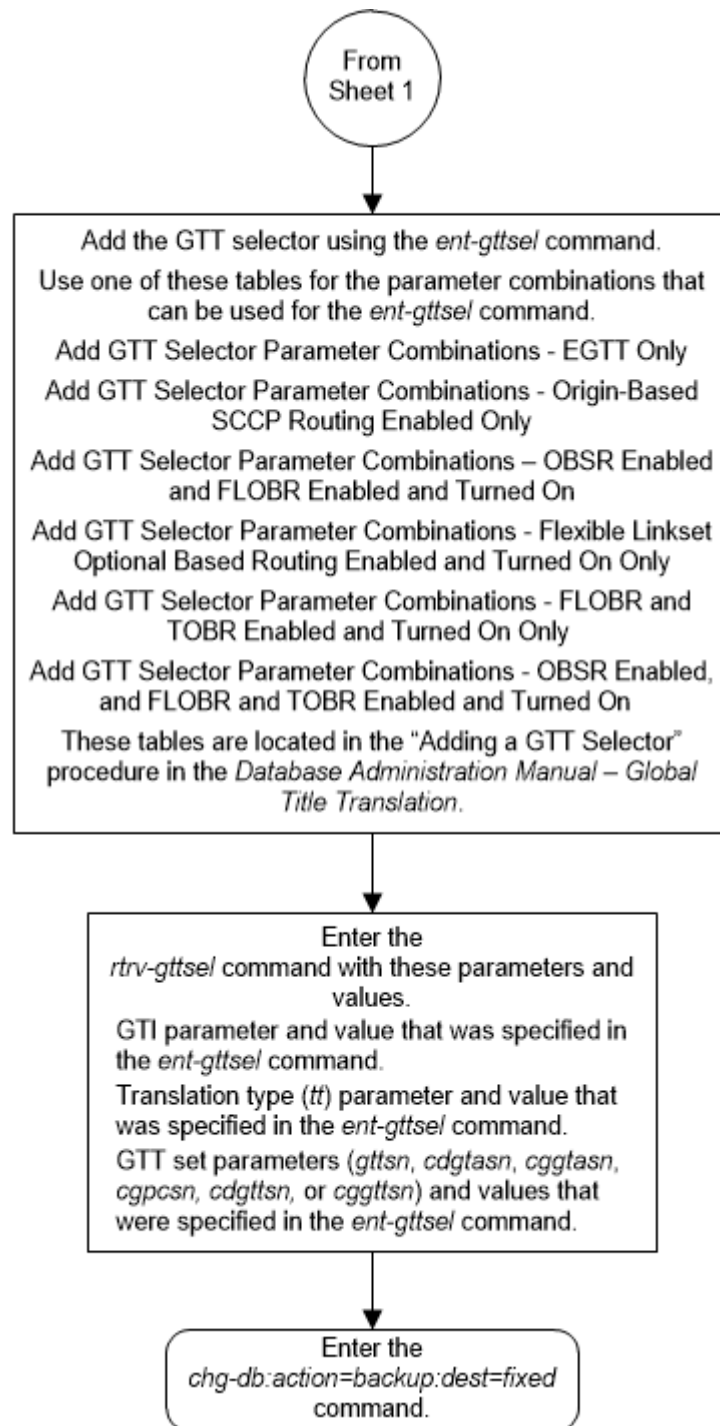

Figure 4-9 Add a GTT Selector - Sheet 2 of 2



Removing a GTT Selector

Use the following procedure to delete the global title selector using the *dlt-gttset* command.

The *dlt-gttset* command uses these parameters.

:gti/gtia/gtii/gtiis/gtin/gtins/gtin24 – The global title indicator. The GTI defines the domain as shown in this list.

- gti and gtia - ANSI global title indicator with the values 0 or 2
- gtii - ITU international (ITU-I) global title indicator with the values, 0, 2, or 4
- gtiis - ITU international (ITU-I) spare global title indicator with the values, 0, 2, or 4
- gtin - ITU national (ITU-N) global title indicator with the values 0, 2, or 4.
- gtins - ITU national (ITU-N) spare global title indicator with the values 0, 2, or 4.
- gtin24 - ITU-N24 spare global title indicator with the values 0, 2, or 4.

:cgssn – The CgPA subsystem number that is assigned to the GTT selector.

:eaglegen – Indicates whether the GTT selector is used by messages generated by the EAGLE. If the GTT selector is used by messages generated by the EAGLE, the entry Eagle-Gen is shown in the LSN column of the rtrv-gttsel output.

:lsn – The name of the linkset that is assigned to the GTT selector.

:selid – The selector ID that is assigned to the GTT selector.

:tt – The global title translation type. (0-255)

:nai – The nature of address indicator.

:naiv – The nature of address indicator value. (0-127) (See [Removing a GTT Selector](#) for NAI/NAIV mapping)

 **Note:**

The nature of address indicator parameters (naiv or nai) can be specified by supplying either a mnemonic or an explicit value. At no time may both the mnemonic and the explicit value be specified at the same time for the same parameter. You can specify either the naiv or nai parameter. [Removing a GTT Selector](#) shows the mapping between the naiv and the nai parameters.

Table 4-14 NAI/NAIV Mapping

NAIV	NAI	Description
0	---	Unknown
1	Sub	Subscriber Number
2	Rsvd	Reserved for national use
3	Natl	National significant number
4	Intl	International number
5-127	---	Spare

:np – The numbering plan.

:npv – The numbering plan value. (0-15) (See [Removing a GTT Selector](#) for NP/NPV mapping)

 **Note:**

The numbering plan parameters (`npv` or `np`) can be specified by supplying either a mnemonic or an explicit value. At no time may both the mnemonic and the explicit value be specified at the same time for the same parameter. You can specify either the `npv` or `np` parameter. [Removing a GTT Selector](#) shows the mapping between the `npv` and the `np` parameters.

Table 4-15 NPV/NP Mapping

NPV	NP	Description
0	---	Unknown
1	E164	ISDN/telephony numbering plan
2	Generic	Generic numbering plan
3	X121	Data numbering plan
4	F69	Telex numbering plan
5	E210	Maritime mobile numbering plan
6	E212	Land mobile numbering plan
7	E214	ISDN/mobile numbering plan
8	Private	Private network or network-specific numbering plan
9-15	---	Spare

1. Display the GTT selectors assigned to a specified domain using the `rtrv-gttset` command.

This is an example of the possible output.

```
rlghncxa03w 10-07-07 00:28:31 GMT EAGLE5 42.0.0
```

```

GTI                CG                CDPA                CGPA
ANSI TT  NP      NAI  SSN  SELID  LSN      GTTSET          GTTSET
  2   75  --      ---  ---  55     any      lidb            (cdgta)
----- (--- )
  2   100 --      ---  ---  56     any      t800            (cdgta)
----- (--- )
  2   150 --      ---  ---  57     any      lidb            (cdgta)
----- (--- )

```

```

GTI                CG                CDPA                CGPA
INT  TT  NP      NAI  SSN  SELID  LSN      GTTSET          GTTSET
  2   0  --      ---  ---  none   any      s1000          (cdgta)
----- (--- )
  2   87 --      ---  ---  none   any      imsi           (cdgta)
----- (--- )
  2   100 --      ---  ---  none   any      imsi           (cdgta)
----- (--- )
  4   0  dflt  dflt  ---  none   any      s1000          (cdgta)
----- (--- )
  4   0  e164  intl  ---  none   any      -----        (--- )

```



```

s2000      (cggta)
  4   97  e210  5   100 100  any      abcd1234 (cdgta)
----- (--- )
  4   101 e210  5   101 101  lsnll    imsi     (cdgta)
----- (--- )
  4   150 e210  5   --- none Eagle-Gen abcd1234 (cdgta)
----- (--- )
  4   219 e210  11  20  20  any      gttset9  (cdgta)
----- (--- )
  4   219 e210  11  21  20  any      gttset9  (cdgta)
----- (--- )
  4   219 e210  11  21  22  any      gttset9  (cdgta)
----- (--- )
  4   219 e210  11  23  22  any      gttset9  (cdgta)
----- (--- )
  4   219 e210  11  23  24  any      gttset9  (cdgta)
----- (--- )
  4   219 e210  11  23  25  any      gttset9  (cdgta)
----- (--- )
  4   219 e210  11  26  25  any      gttset9  (cdgta)
----- (--- )

GTI          CG          CDPA          CGPA
NAT  TT  NP      NAI  SSN  SELID  LSN      GTTSET      GTTSET

GTI          CG          CDPA          CGPA
N24  TT  NP      NAI  SSN  SELID  LSN      GTTSET      GTTSET

GTI          CG          CDPA          CGPA
INTS TT  NP      NAI  SSN  SELID  LSN      GTTSET      GTTSET
  2   20  --      ---  ---  none  any      setint075(cdgta)
----- (--- )

GTI          CG          CDPA          CGPA
NATS TT  NP      NAI  SSN  SELID  LSN      GTTSET      GTTSET
  2   20  --      ---  ---  none  any      setint075(cdgta)
----- (--- )

```

If the Origin-based SCCP Routing feature is not enabled and the Flexible Linkset Optional Based Routing feature is not enabled and turned on, the CGSSN, LSN, CDPA GTTSET and CGPA GTTSET columns are not shown. The GTTSN column is shown in place of the CDPA GTTSET and CGPA GTTSET columns. The GTI ANSI, GTI INT, GTI INTS, GTI NAT, GTI NATS and GTI N24 are replaced by the GTIA, GTI I, GTI IS, GTIN, GTINS, GTIN24 columns.

2. Delete the GTT selector from the database using the `dlt-gttset` command.

[Table 4-16](#) and [Table 4-17](#) shows the parameter combinations that can be used with the `dlt-gttset` command.

Table 4-16 Remove GTT Selector Parameter Combinations - GTI=2 or GTI=4

GTT Set Name Column Header in the RTRV-GTTSEL Output - GTTSN		GTT Set Column Header in the RTRV-GTTSEL Output - CDPA GTTSET and CGPA GTTSET			
:gti/gtia/ gtii/gtin/ gtiis/gtins/ gtin24=2	:gtii/gtin/ gtiis/gtins/ gtin24=4	:gti/gtia/ gtii/gtin/ gtiis/gtins/ gtin24=2	:gti/gtia/ gtii/gtin/ gtiis/gtins/ gtin24=2	:gtii/gtin/ gtiis/gtins/ gtin24=4	:gtii/gtin/ gtiis/gtins/ gtin24=4
:tt=<the translation type assigned to the GTT selector> (See Note 1)	:tt=<the translation type assigned to the GTT selector> (See Note 1)	:tt=<the translation type assigned to the GTT selector> (See Note 1)	:tt=<the translation type assigned to the GTT selector> (See Note 1)	:tt=<the translation type assigned to the GTT selector> (See Note 1)	:tt=<the translation type assigned to the GTT selector> (See Note 1)
:selid<the SELID value assigned to the GTT selector> (See Notes 1 and 2)	:nai/ naiv=<the NAI value assigned to the GTT selector> (See Notes 1, 2, and 5)	:cgssn=<the CGSSN value assigned to the GTT selector> (See Notes 1 and 2)	:eaglegen=ye s (See Note 3)	:nai/ naiv=<the NAI value assigned to the GTT selector> (See Notes 1, 2, 4, and 5)	:nai/ naiv=<the NAI value assigned to the GTT selector> (See Notes 1, 2, 4, and 5)
	:np/npv=<the NP value assigned to the GTT selector> (See Notes 1, 2, and 5)	:selid<the SELID value assigned to the GTT selector> (See Notes 1, 2, and 5)	:lsn<the LSN value assigned to the GTT selector> (See Notes 1, 2, and 3)	:np/npv=<the NP value assigned to the GTT selector> (See Notes 1, 2, 4, and 5)	:np/npv=<the NP value assigned to the GTT selector> (See Notes 1, 2, 4, and 5)
				:cgssn<the CGSSN value assigned to the GTT selector> (See Notes 1, 2, and 4)	:eaglegen=ye s (See Notes 3 and 4)
				:selid<the SELID value assigned to the GTT selector> (See Notes 1, 2, and 4)	
				:lsn<the LSN value assigned to the GTT selector> (See Notes 1, 2, 3, and 4)	

Table 4-16 (Cont.) Remove GTT Selector Parameter Combinations - GTI=2 or GTI=4

GTT Set Name Column Header in the RTRV-GTTSEL Output - GTTSN	GTT Set Column Header in the RTRV-GTTSEL Output - CDPA GTTSET and CGPA GTTSET
Notes:	
<p>a. The values for these parameters must be entered as shown in the <code>rtrv-gttset</code> output for the GTT selector that is being removed, except for the <code>nai/naiv</code> and <code>np/npv</code> parameters. Refer to Removing a GTT Selector and Removing a GTT Selector for the values that can be used.</p> <p>b. If dashes, the value <code>any</code>, or the value <code>none</code> are shown for this value in the GTT selector, this parameter cannot be specified with the <code>dlt-gttset</code> command.</p> <p>c. A GTT selector is used by messages generated by the EAGLE if the value <code>Eagle-Gen</code> is shown in the <code>LSN</code> column for the GTT selector. For this GTT selector, the <code>eagle-gen=yes</code> parameter must be specified with the <code>dlt-gttset</code> command.</p> <p>d. If the GTT selector contains the value <code>DFLT</code> in the <code>NP</code> and <code>NAI</code> columns of the <code>rtrv-gttset</code> output, the <code>cgssn</code>, <code>selid</code>, <code>lsn</code>, and <code>eagle-gen=yes</code> parameters cannot be specified with the <code>dlt-gttset</code> command.</p> <p>e. The <code>nai/naiv</code> and <code>np/npv</code> parameters can be specified in these combinations.</p> <ul style="list-style-type: none"> • <code>np - nai</code> • <code>np - naiv</code> • <code>npv - nai</code> • <code>npv - naiv</code> 	

Table 4-17 Remove GTT Selector Parameter Combinations - GTI=0

GTT Set Name Column Header in the RTRV-GTTSEL Output - GTTSN	GTT Set Column Header in the RTRV-GTTSEL Output - CDPA GTTSET and CGPA GTTSET
<code>:gti/gtia/gtii/gtin/gtiis/gtins/gtin24=0</code>	<code>:gti/gtia/gtii/gtin/gtiis/gtins/gtin24=0</code>
<code>:selid<the SELID value assigned to the GTT selector> (See Notes 1 and 2)</code>	<code>:selid<the SELID value assigned to the GTT selector> (See Notes 1 and 2)</code>
	<code>:cgssn=<the CGSSN value assigned to the GTT selector> (See Notes 1 and 2)</code>
	<code>:lsn<the LSN value assigned to the GTT selector> (See Notes 1 and 2)</code>
Notes:	
<p>a. The values for these parameters must be entered as shown in the <code>rtrv-gttset</code> output for the GTT selector that is being remove.</p> <p>b. If dashes, the value <code>any</code>, or the value <code>none</code> are shown for this value in the GTT selector, this parameter cannot be specified with the <code>dlt-gttset</code> command.</p>	

For this example, enter this command.

```
dlt-gttset:gtii=4:tt=0:np=e164:nai=intl
```

When the command has successfully completed, this message should appear:

```
rlghncxa03w 06-10-07 00:28:31 GMT EAGLE5 36.0.0
DLT-GTTSEL: MASP A - COMPLTD
```

3. Verify the changes using the `rtrv-gttsel` command with the `gti/gtia/gtii/gtiis/gtin/gtins/gtin24` and `tt` parameters and values specified in 2.

For this procedure, enter the following command.

```
rtrv-gttsel:gtii=4:tt=0
```

 **Note:**

If the global title indicator value is 0, the `tt` parameter cannot be specified with the `rtrv-gttsel` command.

This is an example of the possible output.

```
rlghncxa03w 09-05-07 00:28:31 GMT EAGLE5 41.0.0

GTI              CG              CDPA              CGPA
INTL TT  NP      NAI  SSN  SELID  LSN      GTTSET          GTTSET
4    0  dflt   dflt --- none any      s1000    (cdgta)
----- (--- )
```

4. Back up the new changes using the `chg-db:action=backup:dest=fixed` command.

These messages should appear, the active Maintenance and Administration Subsystem Processor (MASP) appears first.

```
BACKUP (FIXED) : MASP A - Backup starts on active MASP.
BACKUP (FIXED) : MASP A - Backup on active MASP to fixed disk
complete.
BACKUP (FIXED) : MASP A - Backup starts on standby MASP.
BACKUP (FIXED) : MASP A - Backup on standby MASP to fixed disk
complete.
```

Figure 4-10 Remove a GTT Selector

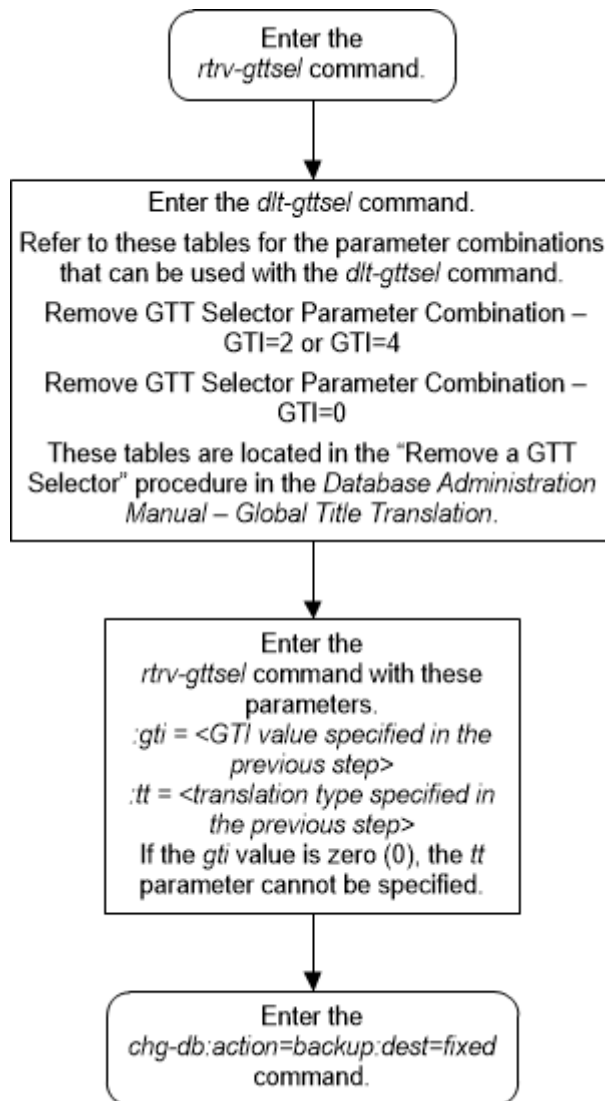

Changing a GTT Selector

Use the following procedure to change the GTT set assigned to a selector using the `chg-gttssel` command.

The `chg-gttssel` command uses these parameters.

`:gti/gtia/gtii/gtiis/gtin/gtins/gtin24` – The global title indicator. The GTI defines the domain as shown in this list.

- `gti` and `gtia` - ANSI global title indicator with the values 0 or 2
- `gtii` - ITU international (ITU-I) global title indicator with the values, 0, 2, or 4
- `gtiis` - ITU international (ITU-I) spare global title indicator with the values, 0, 2, or 4
- `gtin` - ITU national (ITU-N) global title indicator with the values 0, 2, or 4.

- `gtins` - ITU national (ITU-N) spare global title indicator with the values 0, 2, or 4.
- `gtin24` - ITU-N24 spare global title indicator with the values 0, 2, or 4.

`:tt` – The global title translation type, (0-255). The same translation type value can be specified for multiple GTI values. For example, the translation type value 10 can be assigned to an ANSI GTI, an ITU-I GTI, an ITU-I spare GTI, an ITU-N GTI, an ITU-N spare GTI, and an ITU-N24 GTI.

`:msgtype` – The SCCP message type. This parameter allows one or more SCCP message types (UDT/UDTS/XUDT/XUDTS) for every GTT Selector entry. This will help in screening different message types differently.

`:nai` – The nature of address indicator.

`:naiv` – The nature of address indicator value. (0-127) (See [Table 4-18](#) for NAI/NAIV mapping)

 **Note:**

The nature of address indicator parameters (`naiv` or `nai`) can be specified by supplying either a mnemonic or an explicit value. At no time may both the mnemonic and the explicit value be specified at the same time for the same parameter. You can specify either the `naiv` or `nai` parameter. [Table 4-18](#) shows the mapping between the `naiv` and the `nai` parameters.

`:np` – The numbering plan.

`:npv` – The numbering plan value. (0-15) (See [Table 4-19](#) for NP/NPV mapping)

 **Note:**

The numbering plan parameters (`npv` or `np`) can be specified by supplying either a mnemonic or an explicit value. At no time may both the mnemonic and the explicit value be specified at the same time for the same parameter. You can specify either the `npv` or `np` parameter. [Table 4-19](#) shows the mapping between the `npv` and the `np` parameters.

`:gttsn` – the GTT set name.

`:cdgtasn` – The CDGTA GTT set name or the value `none`.

`:cggtsn` – The CGGTA GTT set name or the value `none`.

`:cgpcsn` – The CGPC GTT set name or the value `none`.

`:cgssn` – The CGPA SSN.

`:selid` – The selector ID.

`:cdgttsn` – The CDGTA GTT set name or the value `none`.

`:cggtsn` – The CGGTA GTT set name or the value `none`.

:eagleGen – Indicates whether the GTT selector is used by messages generated by the EAGLE. If the GTT selector is used by messages generated by the EAGLE, the entry Eagle-Gen is shown in the LSN column of the rtrv-gttset output.

:lsn – The name of the linkset that is assigned to the GTT selector.

These tables show the parameter combinations that can be used in this procedure.

- [Table 4-20](#)
- [Table 4-21](#)
- [Table 4-22](#)

Table 4-18 NAIV/NAI Mapping

NAIV	NAI	Description
0	---	Unknown
1	Sub	Subscriber Number
2	Rsvd	Reserved for national use
3	Natl	National significant number
4	Intl	International number
5-127	---	Spare

Table 4-19 NPV/NP Mapping

NPV	NP	Description
0	---	Unknown
1	E164	ISDN/telephony numbering plan
2	Generic	Generic numbering plan
3	X121	Data numbering plan
4	F69	Telex numbering plan
5	E210	Maritime mobile numbering plan
6	E212	Land mobile numbering plan
7	E214	ISDN/mobile numbering plan
8	Private	Private network or network-specific numbering plan
9-15	---	Spare

1. Display the GTT selectors in the database by entering the rtrv-gttset command.

This is an example of the possible output.

```
rlghncxa03w 09-05-07 00:28:31 GMT EAGLE5 41.0.0

GTI          CG          CDPA          CGPA
ANSI TT  NP      NAI  SSN  SELID  LSN      GTTSET      GTTSET
2    75  --      ---  ---  55    any      lidb      (cdgta)
----- (--- )
2    100 --      ---  ---  56    any      t800      (cdgta)
```

```

----- (--- )
2 150 -- --- --- 57 any lidb (cdgta)
----- (--- )

GTI CG CDPA CGPA
INTL TT NP NAI SSN SELID LSN GTTSET GTTSET
2 0 -- --- --- none any s1000 (cdgta)
----- (--- )
2 87 -- --- --- none any imsi (cdgta)
----- (--- )
2 100 -- --- --- none any imsi (cdgta)
----- (--- )
4 0 dflt dflt --- none any s1000 (cdgta)
----- (--- )
4 0 e164 intl --- none any ----- (--- )
s2000 (cggta)
4 97 e210 5 100 100 any abcd1234 (cdgta)
----- (--- )
4 101 e210 5 101 101 lsn1l imsi (cdgta)
----- (--- )
4 150 e210 5 --- none Eagle-Gen abcd1234 (cdgta)
----- (--- )
4 219 e210 11 20 20 any gttset9 (cdgta)
----- (--- )
4 219 e210 11 21 20 any gttset9 (cdgta)
----- (--- )
4 219 e210 11 21 22 any gttset9 (cdgta)
----- (--- )
4 219 e210 11 23 22 any gttset9 (cdgta)
----- (--- )
4 219 e210 11 23 24 any gttset9 (cdgta)
----- (--- )
4 219 e210 11 23 25 any gttset9 (cdgta)
----- (--- )
4 219 e210 11 26 25 any gttset9 (cdgta)
----- (--- )

GTI CG CDPA CGPA
NATL TT NP NAI SSN SELID LSN GTTSET GTTSET

GTI CG CDPA CGPA
N24 TT NP NAI SSN SELID LSN GTTSET GTTSET

```

If the GTTSN column is shown in the `rtrv-gttset` output, only the EGTT feature is turned on. Continue the procedure by performing one of these steps.

- If the new GTT set that will be assigned to the GTT selector is shown in the `rtrv-gttset` output, continue the procedure with 4.
- If the new GTT set that will be assigned to the GTT selector is not shown in the `rtrv-gttset` output, continue the procedure with 3.

If the CDPA GTTSET and CGPA GTTSET columns are shown in the `rtrv-gttset` output, continue the procedure with 2.

2. Display the features that are enabled by entering the `rtrv-ctrl-feat` command.

This is an example of the possible output.

```
rlghncxa03w 09-05-07 00:28:31 GMT EAGLE5 41.0.0
```

The following features have been permanently enabled:

Feature Name	Partnum	Status	Quantity
SCCP Loop Detection	893016501	on	----
SCCP Conversion	893012001	off	----
HC-MIM SLK Capacity	893012707	on	64
Origin Based SCCP Routing	893014301	on	----
TCAP Opcode Based Routing	893027801	on	----
Flex Lset Optnl Based Rtg	893027701	on	----
VGTT with 16 GTT lengths	893024801	on	----
TOBR Opcode Quantity	893027907	on	1000000

The following features have been temporarily enabled:

Feature Name	Partnum	Status	Quantity	Trial Period
Left				

Zero entries found.

The following features have expired temporary keys:

Feature Name	Partnum
Zero entries found.	

Continue the procedure by performing one of these steps.

- If the new GTT set that will be assigned to the GTT selector is shown in the `rtrv-gttset` output, continue the procedure with [4](#).
 - If the new GTT set that will be assigned to the GTT selector is not shown in the `rtrv-gttset` output, continue the procedure with [3](#).
3. Display the GTT set names in the database using the `rtrv-gttset` command. This is an example of the possible output.

```
rlghncxa03w 09-07-07 00:27:31 GMT EAGLE5 41.1.0
```

GTTSN	NETDOM	NDGT
abcd1234	itu	12
imsi	itu	15
lidb	ansi	10
t800	ansi	10
si000	itu	15

GTT-SET table is (5 of 2000) 1% full.

If the Origin-Based SCCP Routing feature is enabled, or if the TCAP Opcode Based Routing feature is enabled and turned on, the SETTYPE column is shown in the `rtrv-gttset` output as shown in the following example.

```
rlghncxa03w 09-07-07 00:29:31 GMT EAGLE5 41.1.0
```

```
GTTSN      NETDOM  SETTYPE  NDGT
abcd1234   itu     CGGTA    12
imsi       itu     CDGTA    15
lidb       ansi    CDGTA    10
t800       ansi    CGGTA    6
s1000      itu     CDGTA    15
s2000      itu     CGPC     -
```

GTT-SET table is (6 of 2000) 1% full.

If the desired GTT set name is shown in the `rtrv-gttset` output, continue the procedure with 4.

If the desired GTT set name is not shown in the `rtrv-gttset` output, perform [Adding a GTT Set](#) to add the desired GTT set. After the GTT set has been added, continue the procedure with 4.

4. Change the selector using the `chg-gttset` command.

These tables show the parameter combinations that can be used in this procedure, based on the features that are turned on, enabled, or enabled and turned on, shown in 1 and 2.

- [Table 4-20](#)
- [Table 4-21](#)
- [Table 4-22](#)

Table 4-20 Change GTT Selector Parameter Combinations - EGTT Only

GTI/GTIA/GTII/ GTIIS/GTIN/GTINS/ GTIN24 = 0 (See Note 2)	GTI/GTIA/GTII/ GTIIS/GTIN/GTINS/ GTIN24 = 2 (See Note 2)	GTII/GTIIIS/GTIN/GTINS/ GTIN24 = 4 (See Note 2)
SELID = <the current SELID value> (See Note 3)	TT = < current translation type>	TT = < current translation type>
GTTSN = <the new GTT set name> (See Note 2)	GTTSN = <the new GTT set name> (See Note 2)	GTTSN = <the new GTT set name> (See Note 2)
	SELID = <the current SELID value> (See Note 3)	NP = <current numbering plan> (See Note 1) or NPV = <current numbering plan value> (See Note 1)
		NAI = <current nature of address indicator> (See Note 1) or NAIV = <current nature of address indicator value> (See Note 1)
		SELID = <the current SELID value> (See Note 3)

Table 4-20 (Cont.) Change GTT Selector Parameter Combinations - EGTT Only

GTI/GTIA/GTII/ GTIIS/GTIN/GTINS/ GTIN24 = 0 (See Note 2)	GTI/GTIA/GTII/ GTIIS/GTIN/GTINS/ GTIN24 = 2 (See Note 2)	GTII/GTIIS/GTIN/GTINS/ GTIN24 = 4 (See Note 2)
Notes:		
1. Refer to Table 4-18 for the <code>nai</code> and <code>naiv</code> parameter values. Refer to Table 4-19 for the <code>np</code> and <code>npv</code> parameter values. These combinations of the <code>np</code> , <code>npv</code> , <code>nai</code> , and <code>naiv</code> parameters can be specified together in the <code>chg-gttset</code> command.		
<ul style="list-style-type: none"> • <code>np - nai</code> • <code>np - naiv</code> • <code>npv - nai</code> • <code>npv - naiv</code> 		
2. If the <code>gti/gtia</code> parameter is specified, the domain of the new GTT set must be ANSI. If the <code>gtii/gtin/gtiis/gtins/gtin24</code> parameter is specified, the domain of the new GTT set must be ITU. The domain of the GTT set can be CROSS, regardless of the value of the <code>gti</code> parameter.		
3. If the value <code>none</code> is shown in the <code>SELID</code> column of the <code>rtrv-gttset</code> output, the <code>selid</code> parameter cannot be specified.		

Table 4-21 Change GTT Selector Parameter Combinations - Origin-Based SCCP Routing Enabled Only

GTI/GTIA/GTII/ GTIIS/GTIN/GTINS/ GTIN24 = 0 (See Note 6)	GTI/GTIA/GTII/ GTIIS/GTIN/GTINS/ GTIN24 = 2 (See Note 6)	GTII/GTIIS/GTIN/GTINS/ GTIN24 = 4 (See Note 6)
CGSSN = <current CGSSN value> (See Note 4)	TT = < current translation type>	TT = < current translation type>
SELID = <current SELID value> (See Note 4)	CGSSN = <current CGSSN value> (See Note 4)	CGSSN = <current CGSSN value> (See Note 4)
CDGTASN = <the new CDGTA GTT set name> or the value none (See Notes 1, 2, 3, 6, and 7)	SELID = <current SELID value> (See Note 4)	SELID = <current SELID value> (See Note 4)
CGGTASN = <the new CGGTA GTT set name> or the value none (See Notes 1, 2, 3, 6, and 7)	CDGTASN = <the new CDGTA GTT set name> or the value none (See Notes 1, 2, 3, 6, and 7)	NP=<current numbering plan> (See Note 5) or NPV = <current numbering plan value> (See Note 5)
CGPCSN = <the new CGPC GTT set name> or the value none (See Notes 1, 2, 3, 6, and 7)	CGGTASN = <the new CGGTA GTT set name> or the value none (See Notes 1, 2, 3, 6, and 7)	NAI = <current nature of address indicator> (See Note 5) or NAIV = <current nature of address indicator value> (See Note 5)
	CGPCSN = <the new CGPC GTT set name> or the value none (See Notes 1, 2, 3, 6, and 7)	CDGTASN = <the new CDGTA GTT set name> or the value none (See Notes 1, 2, 3, 6, and 7)
		CGGTASN = <the new CGGTA GTT set name> or the value none (See Notes 1, 2, 3, 6, and 7)

Table 4-21 (Cont.) Change GTT Selector Parameter Combinations - Origin-Based SCCP Routing Enabled Only

GTI/GTIA/GTII/ GTIIS/GTIN/GTINS/ GTIN24 = 0 (See Note 6)	GTI/GTIA/GTII/ GTIIS/GTIN/GTINS/ GTIN24 = 2 (See Note 6)	GTII/GTIIS/GTIN/GTINS/ GTIN24 = 4 (See Note 6)
		CGPCSN = <the new CGPC GTT set name> or the value none (See Notes 1, 2, 3, 6, and 7)

Notes:

1. If there are two GTT sets assigned to the GTT selector, the value `none` can be specified for the `cdgtasn`, `cggtnsn`, or `cgpcsn` parameters. This will remove the GTT set from the GTT selector. The GTT selector must contain one GTT set.
2. If only a single entry exists for the selector, only the GTT set name can be changed. The value `none` cannot be specified for the `cdgtasn`, `cggtnsn`, or `cgpcsn` parameters.
3. CDGTA GTT sets are shown in the CDPA GTTSET column of the `rtrv-gttset` output. CGGTA and CGPC GTT sets are shown in the CGPA GTTSET column of the `rtrv-gttset` output.
4. If dashes or the values `any` or `none` are shown in the NP, NAI, CGSSN, SELID, or LSN columns of the `rtrv-gttset` output, the parameter corresponding to that column cannot be specified.
5. Refer to [Table 4-18](#) for the `nai` and `naiv` parameter values. Refer to [Table 4-19](#) for the `np` and `npv` parameter values. These combinations of the `np`, `npv`, `nai`, and `naiv` parameters can be specified together in the `chg-gttset` command.
 - `np - nai`
 - `np - naiv`
 - `npv - nai`
 - `npv - naiv`
6. If the `gti/gtia` parameter is specified, the domain of the new GTT set must be ANSI. If the `gtii/gtin/gtiis/gtins/gtin24` parameter is specified, the domain of the new GTT set must be ITU. The domain of the GTT set can be CROSS, regardless of the value of the `gti` parameter.
7. A GTT selector can contain the following combinations of GTT set name parameters.
 - CDGTASN only
 - CGGTASN only
 - CGPCSN only
 - CDGTASN and CGGTASN
 - CDGTASN and CGPCSN

Table 4-22 Change GTT Selector Parameter Combinations - CDGTASN and CGGTASN Columns Shown in the RTRV-GTTSEL Output

GTI/GTIA/GTII/ GTIIS/GTIN/GTINS/ GTIN24 = 0 (See Note 6)	GTI/GTIA/GTII/ GTIIS/GTIN/GTINS/ GTIN24 = 2 (See Note 6)	GTII/GTIIS/GTIN/GTINS/ GTIN24 = 4 (See Note 6)
CGSSN = <current CGSSN value> (See Notes 3, 4, and 7)	TT = < current translation type>	TT = < current translation type>
SELID = <current SELID value> (See Notes 3 and 4)	CGSSN = <current CGSSN value> (See Notes 3, 4, and 7)	CGSSN = <current CGSSN value> (See Notes 3, 4, and 7)

Table 4-22 (Cont.) Change GTT Selector Parameter Combinations - CDGTTSN and CGGTTSN Columns Shown in the RTRV-GTTSEL Output

GTI/GTIA/GTII/ GTIIS/GTIN/GTINS/ GTIN24 = 0 (See Note 6)	GTI/GTIA/GTII/ GTIIS/GTIN/GTINS/ GTIN24 = 2 (See Note 6)	GTII/GTIIIS/GTIN/GTINS/ GTIN24 = 4 (See Note 6)
LSN = <current LSN value> (see Notes 3 and 4)	SELID = <current SELID value> (See Notes 3 and 4)	SELID = <current SELID value> (See Notes 3 and 4)
CDGTTSN = <the new CDGTA GTT set name> or the value none (See Notes 1, 2, 3, 6, 7, 8, 9, and 10)	LSN = <current LSN value> (see Notes 3 and 4)	LSN = <current LSN value> (see Notes 3 and 4)
CGGTTSN = <the new CGGTA GTT set name> or the value none (See Notes 1, 2, 3, 6, 8, 9, and 10)	EAGLEGEN = YES (see Note 3)	EAGLEGEN = YES (see Note 3)
	CDGTTSN = <the new CDGTA GTT set name> or the value none (See Notes 1, 2, 3, 6, 7, 8, 9, and 10)	NP = <current numbering plan> (See Note 5) or NPV = <current numbering plan value> (See Note 5)
	CGGTTSN = <the new CGGTA GTT set name> or the value none (See Notes 1, 2, 3, 6, 8, 9, and 10)	NAI = <current nature of address indicator> (See Note 5) or NAIV = <current nature of address indicator value> (See Note 5)
		CDGTTSN = <the new CDGTA GTT set name> or the value none (See Notes 1, 2, 3, 6, 7, 8, 9, and 10)
		CGGTTSN = <the new CGGTA GTT set name> or the value none (See Notes 1, 2, 3, 6, 8, 9, and 10)

Table 4-22 (Cont.) Change GTT Selector Parameter Combinations - CDGTTSN and CGGTTSN Columns Shown in the RTRV-GTTSEL Output

GTI/GTIA/GTII/ GTIIS/GTIN/GTINS/ GTIN24 = 0 (See Note 6)	GTI/GTIA/GTII/ GTIIS/GTIN/GTINS/ GTIN24 = 2 (See Note 6)	GTII/GTIIIS/GTIN/GTINS/ GTIN24 = 4 (See Note 6)
--	--	--

Notes:

1. If there are two GTT sets assigned to the GTT selector, the value `none` can be specified for the `cdgttsn` or `cggtsn` parameters. This will remove the GTT set from the GTT selector. The GTT selector must contain one GTT set.
2. If only a single entry exists for the selector, only the GTT set name can be changed. The value `none` cannot be specified for the `cdgttsn` or `cggtsn` parameters.
3. If the `LSN` column contains the value `Eagle-Gen`, the `eaglegen=yes` parameter must be specified with the `chg-gttset` command. The `cggtsn`, `cgssn`, `selid`, and `lsn` parameters cannot be specified with the `chg-gttset` command. The new GTT set for this GTT selector must be a `CDGTA` GTT set and can be specified only with the `cdgttsn` parameter.
4. If dashes or the values `any` or `none` are shown in the `NP`, `NAI`, `CGSSN`, `SELID`, or `LSN` columns of the `rtrv-gttset` output, the parameter corresponding to that column cannot be specified.
5. Refer to [Table 4-18](#) for the `nai` and `naiv` parameter values. Refer to [Table 4-19](#) for the `np` and `npv` parameter values. These combinations of the `np`, `npv`, `nai`, and `naiv` parameters can be specified together in the `chg-gttset` command.
 - `np - nai`
 - `np - naiv`
 - `npv - nai`
 - `npv - naiv`
6. If the `gti/gtia` parameter is specified, the domain of the new GTT set must be `ANSI`. If the `gtii/gtin/gtiis/gtins/gtin24` parameter is specified, the domain of the new GTT set must be `ITU`. The domain of the GTT set can be `CROSS`, regardless of the value of the `gti` parameter.
7. If the GTT selector contains a `CGSSN` value, the `CDGTTSN` parameter cannot be specified for the GTT selector. The `CGSSN` parameter cannot be specified with the `CDGTTSN` parameter. The `CGSSN` parameter can be specified only if the Origin-Based SCCP Routing feature is enabled.
8. If the TCAP Opcode Based Routing feature is enabled and turned on, `CDGTA`, `CDSSN`, `DPC`, and `OPCODE` GTT sets, shown with the entries `CDGTA`, `CDSSN`, `DPC`, and `OPCODE` in the `SETTYPE` column in the `rtrv-gttset` output, can be assigned to the GTT selector.
9. If the Origin-Based SCCP Routing feature is enabled, `CDGTA`, `CGGTA`, `CGPC`, `CGSSN`, and `OPC` GTT sets, shown with the entries `CDGTA`, `CGGTA`, `CGPC`, `CGSSN`, and `OPC` in the `rtrv-gttset` output, can be assigned to the GTT selector.
10. If only the Flexible Linkset Optional Based Routing feature is enabled and turned on, `CDGTA`, `CDSSN`, and `DPC` GTT sets, shown with the entries `CDGTA`, `CDSSN`, and `DPC` in the `SETTYPE` column in the `rtrv-gttset` output, can be assigned to the GTT selector.

For this example, enter this command.

```
chg-
gttsel:gtii=4:tt=0:np=e210:naiv=4:cdgttsn=s1000:cggtsn=abcd1
234
```

After the successful completion of this command, this message appears:

```
rlghncxa03w 06-10-07 00:28:31 GMT EAGLE5 36.0.0
CHG-GTTSEL: MASP A - COMPLTD
```

5. Verify the changes by entering the `rtrv-gttset` command with these parameters and values that were specified in 4.

```
gti/gtia/gtii/gtiis/gtin/gtins/gtin24
tt
np/npv
nai/naiv
selid
cgssn
lsn
eaglegen=yes
```

For this example, enter this command.

```
rtrv-gttset:gtii=4:tt=0:np=e210:naiv=4
```

This is an example of the possible output.

```
rlghncxa03w 09-05-02 13:54:39 GMT EAGLE5 41.0.0

GTI          CG          CDPA          CGPA
INTL TT  NP      NAI  SSN  SELID  LSN      GTTSET      GTTSET
4    0  e164   4   --- none  any      s1000      (cdgta)
abcd1234  (cgta)
```

6. Backup the new changes using the `chg-db:action=backup:dest=fixed` command.

These messages should appear, the active Maintenance and Administration Subsystem Processor (MASP) appears first.

```
BACKUP (FIXED) : MASP A - Backup starts on active MASP.
BACKUP (FIXED) : MASP A - Backup on active MASP to fixed disk
complete.
BACKUP (FIXED) : MASP A - Backup starts on standby MASP.
BACKUP (FIXED) : MASP A - Backup on standby MASP to fixed disk
complete.
```

Figure 4-11 Change a GTT Selector

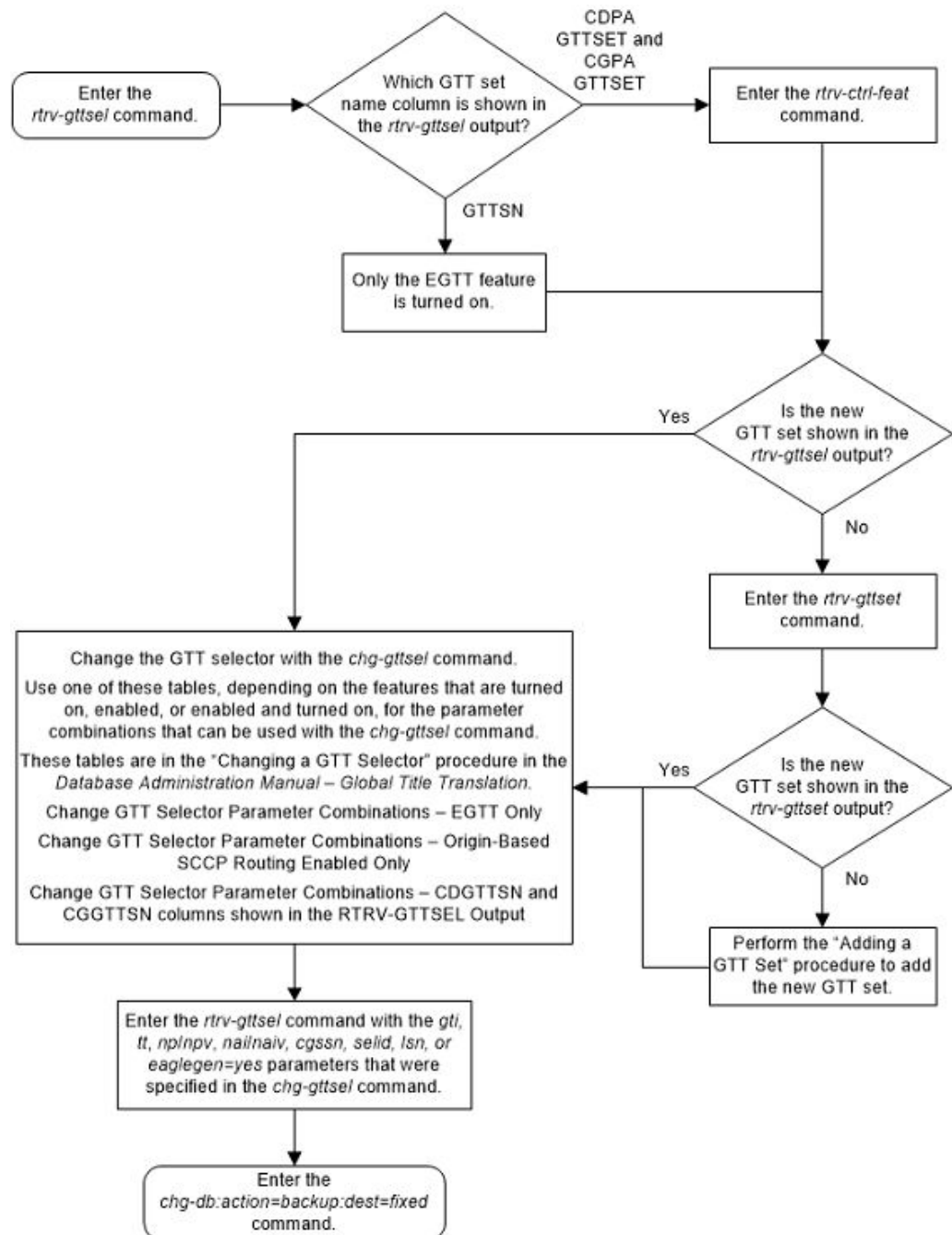

Adding Global Title Address Information

This procedure is used to add global title address (GTA) information for applicable global title selectors required to specify a global title entry. This command adds the routing object (a destination address and a subsystem number) for messages requiring global title translation. The translation is performed on the basis of the GTA, global title indicator (GTI), numbering plan (NP), nature of address indicator (NAI), and

translation type (TT) of each SS7 SCCP message directed to the STP with a routing indicator of 0, indicating that global title translation is required.

The `ent-gta` command uses these parameters:

- `:gttsn` – The GTT set name
- `:gta` – The global title address or the beginning value of a range of global title addresses
- `:egta` – The end of global title address
- `:pc/pca/pci/pcn/pcn24` – The translated point code
- `:ssn` – The translated subsystem number
- `:ri` – The routing indicator
- `:xlat` – The translate indicator
- `:ccgt` – The cancel called global title indicator
- `:force` – The check mated application override
- `:actsn` – The name of the GTT action set that will be assigned to the GTA entry as shown in the `rtrv-gttaset` output.
- `:gtmodid` – The name of the GT modification identifier that will be assigned to the GTA entry as shown in the `rtrv-gtmod` output and provisioned in the [Adding Global Title Modification Information](#) procedure. The GT modification identifier contains the information to modify the numbering plan, nature of address indicator, and the prefix or suffix digits in the called party address or calling party address portion of outbound MSUs.
- `:ppmeasreqd` – This parameter specifies whether per-path measurements are required for the GTA entry.
- `:mrnset` – The MRN set ID, shown in the `rtrv-mrn` output. This parameter can be specified only, and must be specified, if the Flexible GTT Load Sharing feature is enabled and if the `ri=gt` parameter is specified with the `ent-gta` command. If the Flexible GTT Load Sharing feature is enabled, the point code specified with the `ent-gta` command must be assigned to the MRN set specified by this parameter. The status of the Flexible GTT Load Sharing feature is shown in the `rtrv-ctrl-feat` output. To enable the Flexible GTT Load Sharing feature, perform [Activating the Flexible GTT Load Sharing Feature](#).
- `:mapset` – The MAP set ID, shown in the `rtrv-map` output. This parameter can be specified only, and must be specified, if the Flexible GTT Load Sharing feature is enabled and if the `ri=ssn` parameter is specified with the `ent-gta` command. If the Flexible GTT Load Sharing feature is enabled, the point code and SSN specified with the `ent-gta` command must be assigned to the MAP set specified by this parameter. The status of the Flexible GTT Load Sharing feature is shown in the `rtrv-ctrl-feat` output. To enable the Flexible GTT Load Sharing feature, perform [Activating the Flexible GTT Load Sharing Feature](#).
- `:optsn` – The optional GTT set name shown in the `rtrv-gttset` output. [Table 4-23](#) shows the types of GTT sets that can be specified for the `optsn` parameter based on the type of GTT set that is specified for the `gttsn` parameter and the features that are enabled and turned on.

Table 4-23 GTTSN and OPTSN Combinations

GTTSN Set Type	OPTSN Set Type
Origin-Based SCCP Routing Feature Enabled Only	
CDGTA	CGGTA, CGPC The OPC GTT set type can be specified with a CDGTA GTT set, but the OPC GTT set is specified with the <code>opcsn</code> parameter.
CGGTA	CGSSN
CGPC	CGSSN
CGSSN	The <code>optsn</code> parameter cannot be specified.
OPC	CGSSN
Flexible Linkset Optional Based Routing Enabled and Turned On Only	
CDGTA	CDGTA, DPC, CDSSN
CDSSN	CDSSN, DPC, CDGTA
DPC	DPC, CDSSN, CDGTA
Origin-Based SCCP Routing Enabled and Flexible Linkset Optional Based Routing Enabled and Turned On Only	
CDGTA	CDGTA, CGGTA, CGPC, CGSSN, CDSSN, DPC, OPC The OPC GTT set type can be specified with a CDGTA GTT set, but the OPC GTT set is specified with the <code>opcsn</code> parameter.
CGGTA	CDGTA, CGGTA, CGPC, CGSSN, OPC, CDSSN, DPC
CGPC	CDGTA, CGGTA, CGSSN, CGPC, OPC, CDSSN, DPC
CGSSN	CDGTA, CGGTA, CGSSN, CGPC, OPC, CDSSN, DPC
OPC	CDGTA, CGGTA, CGPC, CGSSN, OPC, CDSSN, DPC
CDSSN	CDGTA, CGGTA, CGPC, CGSSN, OPC, DPC, CDSSN
DPC	CDGTA, CGGTA, CGPC, CGSSN, OPC, CDSSN, DPC
Flexible Linkset Optional Based Routing and TCAP Opcode Based Routing Feature Enabled and Turned On Only	
CDGTA	CDGTA, OPCODE, DPC, CDSSN
CDSSN	CDSSN, OPCODE, DPC, CDGTA
OPCODE	OPCODE, CDSSN, DPC, CDGTA
DPC	DPC, OPCODE, CDSSN, CDGTA
Origin-Based SCCP Routing Enabled, Flexible Linkset Optional Based Routing and TCAP Opcode Based Routing Feature Enabled and Turned On	
CDGTA	CDGTA, CGGTA, CGPC, CGSSN, CDSSN, OPCODE, DPC, OPC The OPC GTT set type can be specified with a CDGTA GTT set, but the OPC GTT set is specified with the <code>opcsn</code> parameter.

Table 4-23 (Cont.) GTTSN and OPTSN Combinations

GTTSN Set Type	OPTSN Set Type
CGGTA	CDGTA, CGGTA, CGPC, CGSSN, CDSSN, OPCODE, OPC, DPC The <code>opcsn</code> parameter cannot be specified.
CGPC	CDGTA, CGGTA, CGPC, CGSSN, CDSSN, OPCODE, OPC, DPC The <code>opcsn</code> parameter cannot be specified.
CGSSN	CDGTA, CGGTA, CGPC, CGSSN, CDSSN, OPCODE, OPC, DPC The <code>opcsn</code> parameter cannot be specified.
OPC	CDGTA, CGGTA, CGPC, CGSSN, OPC, CDSSN, OPCODE, DPC
CDSSN	CDGTA, CGGTA, CGPC, CGSSN, CDSSN, OPCODE, DPC, OPC The OPC GTT set type can be specified with a CDSSN GTT set, but the OPC GTT set is specified with the <code>opcsn</code> parameter.
OPCODE	CDGTA, CGGTA, CGPC, CGSSN, CDSSN, OPCODE, DPC, OPC The OPC GTT set type can be specified with an OPCODE GTT set, but the OPC GTT set is specified with the <code>opcsn</code> parameter.
DPC	CDGTA, CGGTA, CGPC, CGSSN, CDSSN, OPCODE, DPC, OPC The OPC GTT set type can be specified with a DPC GTT set, but the OPC GTT set is specified with the <code>opcsn</code> parameter.

:`opcsn` – The OPC GTT set name shown in the `rtrv-gttset` output.

:`cgssn` – The CgPA subsystem number or the beginning value of a range of CgPA subsystem numbers

:`ecgssn` – The end value of a range of CgPA subsystem numbers

:`cgpc/cgpca/cgpci/cgpcn/cgpcn24` – The CgPA point code

:`opc/opca/opci/opcn/opcn24` – The originating point code

:`dpc/dpca/dpci/dpcn/dpcn24` – The destination point code

:`cdssn` – The CdPA subsystem number or the beginning value of a range of CdPA subsystem numbers

:`ecdssn` – The end value of a range of CdPA subsystem numbers

:`cgselid` – The CgPA selector ID

:`cdselid` – The CdPA selector ID

:`fallback` – The action to be taken when the final translation does not match while performing global title translation using a FLOBR-specific GTT mode.

`:testmode` – This parameter invokes a field-safe test tool to debug the rules used for the Flexible Linkset Optional Based Routing or TCAP Opcode Based Routing features.

`:transmeasrqd` - GTT Translation Measurement Required. This parameter specifies whether to perform per GTT Translation Measurements.

`:cgcnvsn` – The CgPA conversion set name

`:family` – The ANSI TCAP family field in the incoming message

`:opcode` – The TCAP opcode field in the incoming message

`:pkgtype` – The TCAP package type. [Table 4-31](#) shows the ANSI and ITU TCAP package types.

`:acn` – The application context name (ACN) field in the ITU TCAP message

`:loopset` - The value of this parameter is the name of the loopset that is assigned to the GTA. This parameter can be specified only if the SCCP Loop Detection feature is enabled. Enter the `rtrv-loopset` command to verify that the SCCP Loop Detection feature is enabled. By default, the value of the `loopset` parameter is “none” because no loopset is assigned to the GTA.

`:cggtmod` - The calling party GT modification indicator. This parameter specifies whether or not calling party global title modification is required. The values for this parameter are `yes` (calling party global title modification is required) or `no` (calling party global title modification is not required). This parameter can be specified only if the AMGTT or AMGTT CgPA Upgrade feature is enabled. Enter the `rtrv-ctrl-feat` command to verify that either the AMGTT or AMGTT CgPA Upgrade feature is enabled.

 **Note:**

The command line on the terminal can contain up to 150 characters. If the parameters and values specified with the `ent-gta` command are too long to fit on the `ent-gta` command line, perform [Changing Global Title Address Information](#) to complete adding the GTA entry.

The Global Title Translation (GTT) feature and the Enhanced Global Title Translation (EGTT) feature must be `on` before using this command. Use the `rtrv-feat` command to verify the settings. If the features are off, turn them on using the `chg-feat:gtt=on:egtt=on` command.

 **Note:**

Once the Global Title Translation (GTT) feature and the Enhanced Global Title Translation (EGTT) feature are turned on with the `chg-feat` command, they cannot be turned off.

The GTT feature and the EGTT feature must be purchased before you turn these features on. If you are not sure whether you have purchased the GTT feature and/or the EGTT feature, contact your Oracle Sales Representative or Account Representative.

If the Variable-Length Global Title Translation (VGTT) feature is off, shown the entry `VGTT = off`, the global title address length must be equal to the number of digits specified by the given GTT set name. The length of the global title address can be verified with the `rtrv-gttset` command.

If the Variable-Length Global Title Translation (VGTT) feature is on, shown the entry `VGTT = on`, up to 10 different length global title addresses can be assigned to a GTT set. If the Support for 16 GTT Lengths in VGTT feature is enabled and turned on, up to 16 different length global title addresses can be assigned to a GTT set. The length of the global title address is only limited by the range of values for the `gta` and `egta` parameters, one to 21 digits, and by the global title addresses already assigned to the GTT set name. The `ndgt` parameter of the `ent-gttset` command has no effect on the length of the global title address. As global title addresses of different lengths are assigned to a specific translation type, these lengths are displayed in the `NDGT` field of the `rtrv-gttset` command output, as shown in the following example.

```
rlghncxa03w 09-07-07 00:30:31 GMT EAGLE5 41.1.0
```

GTTSN	NETDOM	NDGT
lidx	ansi	3, 7, 10
t800	ansi	6
si000	itu	15
imsi	itu	15
abcd1234	itu	12

```
GTT-SET table is (5 of 2000) 1% full.
```

In this example of the `rtrv-gttset` command output, the GTT set `lidx` contains three different length global title addresses; global title addresses containing three digits, seven digits, and 10 digits.

If the GTT set contains the maximum number of different length global title addresses, and another global title address is specified for the GTT set name, the length of the global title address being added to the GTT set name must be the same as one of the lengths already assigned to the GTT set name. If the length of the global title address does not match one of the lengths already assigned to the GTT set name, the `ent-gta` command is rejected with this message

```
E4008 Cmd Rej: Exceeding max GTA Lengths supported per GTTSET
```

If the GTT set name has less than the maximum number of different length global title addresses assigned to it, and another global title address is specified for the GTT set name, the length of the global title address can be from one to 21 digits and does not have to match the length of the other global title addresses assigned to the GTT set name.

Refer to [Variable-length Global Title Translation Feature](#) for more information about this feature.

The range, as specified by the start and end global title addresses, cannot already exist in the global title translation data for the specified translation type. If the ranges overlap, the range of global title addresses cannot be split and the `ent-gta` command is rejected with this message.

```
E2401 Cmd Rej:GTA range overlaps a current range
```

Along with error message 2401, a list of the overlapped global title addresses is displayed as shown in the following example.

```
rlghncxa03w 06-10-24 08:29:15 GMT EAGLE5 36.0.0  
The following GTA ranges overlap the input GTA range
```

START GTA	END GTA
8005550000	8005551999
8005552000	8005553999
8005554000	8005555999

```
ENT-GTA: MASP A - Command Aborted
```

The translate indicator (`xlat`) must be `DPCSSN` if the `SSN` parameter is specified. If the translate indicator is set to `DPCNGT`, the value of the `RI` parameter must be `GT`.

If a point code is the STP's True PC, then the value of the `XLAT` parameter must be set to `DPCSSN` and the value of the `RI` parameter must be set to `SSN`. If the `SSN` parameter is specified and a point code is the STP's True PC, then the subsystem number specified must exist in the `SS-APPL` table. This can be verified with the `rtrv-ss-appl` command. To execute the `rtrv-ss-appl` command, these features must be enabled, and turned on if necessary.

- `LNP` - shown by the entry `LNP TNs` with a quantity greater than zero in the `rtrv-ctrl-feat` command output
- `ATINP` - shown by the entry `ATINP` in the `rtrv-ctrl-feat` command output with the status set to on
- `EIR` - shown by the entry `EIR` in the `rtrv-ctrl-feat` command output as being permanently or temporarily enabled and with the status set to on.
- `INP` - shown by the entry `INP` in the `rtrv-ctrl-feat` command output with the status set to on.
- `V-FLEX` - shown by the entry `VFLEX` in the `rtrv-ctrl-feat` command output with the status set to on.
- `ANSI-41 INP Query` - shown by the entry `ANSI-41 INP Query` in the `rtrv-ctrl-feat` command output with the status set to on.
- `ANSI41 AIQ` - shown by the entry `ANSI41 AIQ` in the `rtrv-ctrl-feat` command output.

 **Note:**

The Local Number Portability (LNP), Equipment Identity Register (EIR), INAP Number Portability (INP), V-Flex, ATINP, ANSI41 AIQ, or ANSI-41 INP Query features must be purchased before you can enable the LNP, ATINP, or ANSI41 AIQ features, or enable and turn on the EIR, INP, V-Flex, or ANSI-41 INP Query features. If you are not sure whether you have purchased the LNP, EIR, or INP, V-Flex, ATINP, or ANSI-41 INP Query feature, contact your Oracle Sales Representative or Account Representative. Once the LNP, ATINP, or ANSI41 AIQ feature is enabled with the `enable-ctrl-feat` command, or the EIR, INP, V-Flex, and ANSI-41 INP Query features are turned on with the `chg-ctrl-feat` command, they cannot be turned off or disabled.

A point code must exist as a destination in the route table or reside in a cluster that exists as a destination in the route table (for global title routing) unless the point code is the STP's true point code.

If a final GTT is specified (`ri=ssn`) with the `xlat=dpc` parameter, and the value of the `force` parameter is `no`, the point code must be in the Remote Point Code/Mated Application table. Verify this by entering the `rtrv-map` command. If this point code and subsystem number is not defined as a mated application, perform one of these procedures to add the point code and subsystem number to the database as a mated application:

- [Provisioning a Solitary Mated Application](#)
- [Provisioning a Dominant Mated Application](#)
- [Provisioning a Load Shared Mated Application](#)
- [Provisioning a Combined Dominant/Load Shared Mated Application.](#)

The point code and subsystem number do not have to be in the mated application table when the `ent-gta` command is executed when these parameters are specified with the `ent-gta` command.

- `ri=gt`
- `xlat=dpcssn` and `ri=ssn` (provided the point code value is not the STP's true point code)

If the point code and subsystem are not in the mated application table when either of these parameters are specified with the `ent-gta` command, the EAGLE creates a solitary mated application in the mated application table using the point code and subsystem values specified in the `ent-gta` command.

If the `xlat=none` parameter is specified for a global title translation, the global title translation entry can contain any data except for the routing data defined by these parameters.

- `pc/pca/pci/pcn/pcn24`
- `ssn`
- `ri`
- `force=yes`

The [GTA Entries with the XLAT=NONE Parameter](#) part of the [GTT Actions](#) section described the behavior of the `xlat=none` parameter.

These tables show the valid parameter combinations that can be used with the `ent-gta` command.

- [Table 4-24](#)
- [Table 4-25](#)
- [Table 4-26](#)
- [Table 4-27](#)
- [Table 4-28](#)
- [Table 4-29](#)
- [Table 4-30](#)
- [Table 4-31](#)
- [Table 4-32](#)

The EAGLE can contain 269,999, 400,000, or 1,000,000 global title addresses. The system default is 269,999 global title addresses. This quantity can be increased to 400,000 by enabling the feature access key for part number 893-0061-01, or to 1,000,000 by enabling the feature access key for part number 893-0061-10. For more information on enabling these feature access keys, refer to [Enabling the XGTT Table Expansion Feature](#).

Canceling the RTRV-GTA Command

Because the `rtrv-gta` command used in this procedure can output information for a long period of time, the `rtrv-gta` command can be canceled and the output to the terminal stopped. There are three ways that the `rtrv-gta` command can be canceled.

- Press the `F9` function key on the keyboard at the terminal where the `rtrv-gta` command was entered.
- Enter the `canc-cmd` without the `trm` parameter at the terminal where the `rtrv-gta` command was entered.
- Enter the `canc-cmd:trm=<xx>`, where `<xx>` is the terminal where the `rtrv-gta` command was entered, from another terminal other than the terminal where the `rtrv-gta` command was entered. To enter the `canc-cmd:trm=<xx>` command, the terminal must allow Security Administration commands to be entered from it and the user must be allowed to enter Security Administration commands. The terminal's permissions can be verified with the `rtrv-secu-trm` command. The user's permissions can be verified with the `rtrv-user` or `rtrv-secu-user` commands.

For more information about the `canc-cmd` command, go to *Commands User's Guide*.

Table 4-24 GTA Parameter Combinations - No SETTYPE Column in RTRV-GTTSET Output

RI = GT XLAT=DPCNGT	RI = GT XLAT=DPCSSN	RI = GT XLAT=DPC	RI = SSN XLAT=DPCSSN	RI = SSN XLAT=DPC
Mandatory Parameters				

Table 4-24 (Cont.) GTA Parameter Combinations - No SETTYPE Column in RTRV-GTTSET Output

RI = GT XLAT=DPCNGT	RI = GT XLAT=DPCSSN	RI = GT XLAT=DPC	RI = SSN XLAT=DPCSSN	RI = SSN XLAT=DPC
GTTSN	GTTSN	GTTSN	GTTSN	GTTSN
PC/PCA/PCI/	PC/PCA/PCI/	PC/PCA/PCI/	PC/PCA/PCI/	PC/PCA/PCI/
PCN/PCN24 (See Notes 1, 2, and 6)	PCN/PCN24 (See Notes 1, 2, and 6)	PCN/PCN24 (See Notes 1, 2, and 6)	PCN/PCN24 (See Notes 1, 2, and 6)	PCN/PCN24 (See Notes 1, 2, and 6)
GTA (See Notes 3, 4, 5, and 7)	GTA (See Notes 3, 4, 5, and 7)	GTA (See Notes 3, 4, 5, and 7)	GTA (See Notes 3, 4, 5, and 7)	GTA (See Notes 3, 4, 5, and 7)
	SSN		SSN	

If only the EGTT feature is on, the SETTYPE column is not shown in the `rtrv-gttset` output.

There are other optional parameters that can be used with this entry. Refer to [Table 4-33](#) for these parameters.

Parameter Values:

GTTSN – The GTT set name from the GTTSN column of the `rtrv-gttset` output.

GTA – 1 - 21 digits or 1 - 21 hexadecimal digits

PC/PCA/PCI/PCN/PCN24 – See Note 1

SSN – 0 - 255

Table 4-24 (Cont.) GTA Parameter Combinations - No SETTYPE Column in RTRV-GTTSET Output

RI = GT XLAT=DPCNGT	RI = GT XLAT=DPCSSN	RI = GT XLAT=DPC	RI = SSN XLAT=DPCSSN	RI = SSN XLAT=DPC
Notes:				
<ol style="list-style-type: none"> The <code>pc/pca/pci/pcn/pcn24</code> parameters are used to assign either ANSI, ITU-I, ITU-I spare, 14-bit ITU-N, 14-bit ITU-N spare, or 24-bit ITU-N point codes to the global title address (GTA). <ul style="list-style-type: none"> <code>pc/pca</code> = ANSI point code <code>pci</code> = ITU-I or ITU-I spare point code <code>pcn</code> = 14-bit ITU-N or 14-bit ITU-N spare point code <code>pcn24</code> = 24-bit ITU-N point code. The domain (ANSI or ITU) of the point code and GTT set must be the same, unless the ANSI/ITU SCCP Conversion feature is enabled. If the ANSI/ITU SCCP Conversion feature is enabled, a GTA may contain an ANSI point code and an ITU GTT set, or an ITU point code and an ANSI GTT set. The CROSS GTT set, a GTT set containing the NETDOM value CROSS, can be specified with either ANSI or ITU point codes. If the VGTT feature is on, shown by the <code>VGTT = on</code> entry in the <code>rtrv-feat</code> output, and the GTT set name contains 10 different length GTAs, the length of the GTA must match any existing GTA assigned to the GTT set name. If the Support for 16 GTT Lengths for VGTT feature is enabled and turned on, shown by the <code>VGTT with 16 GTT lengths</code> entry in the <code>rtrv-ctrl-feat</code> output, and the GTT set name contains 16 different length GTAs, the length of the GTA must match any existing GTA assigned to the GTT set name. If the GTT set name contains less than the maximum number of different length GTAs, the length of the GTA can be from 1 to 21 digits. If the VGTT feature is off, the length of the GTA must contain the number of digits defined by the NDGT field of the <code>rtrv-gttset</code> output. If the point code is the EAGLE's point code, then the <code>xlat</code> parameter value must be <code>dpcssn</code> and the <code>ri</code> parameter value must be <code>ssn</code>. Hexadecimal digits (0-9, a-f, A-F) can be specified for the <code>gta</code> or <code>egta</code> parameters only if the Hex Digit support for GTT feature is enabled. 				

Table 4-25 GTTSN = CDGTA GTT Set Parameter Combinations

XLAT=DPCNGT, DPCSSN, or DPC	XLAT=NONE
Mandatory Parameters	
GTTSN – The GTT set name from the GTTSN column of the <code>rtrv-gttset</code> output containing the value CDGTA in the SETTYPE column.	GTTSN – The GTT set name from the GTTSN column of the <code>rtrv-gttset</code> output containing the value CDGTA in the SETTYPE column.
RI – GT, SSN (See Notes 6, 7, 8, and 9)	GTA – 1 - 21 digits or 1 - 21 hexadecimal digits (See Notes 3, 4, 5, and 10)
PC/PCA/PCI/PCN/PCN24 (See Notes 1, 2, and 6)	
GTA – 1 - 21 digits or 1 - 21 hexadecimal digits (See Notes 3, 4, 5, and 10)	
Optional Parameters	

Table 4-25 (Cont.) GTTSN = CDGTA GTT Set Parameter Combinations

XLAT=DPCNGT, DPCSSN, or DPC	XLAT=NONE
SSN – 0 - 255. Default value – no SSN value is specified. (See Note 9)	EGTA – 1 - 21 digits or 1 - 21 hexadecimal digits. (See Note 10) Default = same as the GTA value. The length of the EGTA value must be the same as the GTA value. These parameters cannot be specified with the <code>xlat=none</code> parameter. <ul style="list-style-type: none"> • <code>pc/pca/pci/pcn/pcn24</code> • <code>ssn</code> • <code>ri</code> • <code>force=yes</code>

OPTSN – The GTT set name from the GTTSN column of the `rtrv-gttset` output. Refer to [Table 4-23](#) for the valid GTT set types that can be specified. Default value – no GTT set is specified.

OPCSN – The GTT set name from the GTTSN column of the `rtrv-gttset` output containing the value OPC in the SETTYPE column. Default value – no OPC GTT set is specified.

There are other optional parameters that can be used with this entry. Refer to [Table 4-33](#) for these parameters.

Table 4-25 (Cont.) GTTSN = CDGTA GTT Set Parameter Combinations

XLAT=DPCNGT, DPCSSN, or DPC	XLAT=NONE
Notes:	
<ol style="list-style-type: none"> 1. The <code>pc/pca/pci/pcn/pcn24</code> parameters are used to assign either ANSI, ITU-I, ITU-I spare, 14-bit ITU-N, 14-bit ITU-N spare, or 24-bit ITU-N point codes to the global title address (GTA). <ul style="list-style-type: none"> • <code>pc/pca</code> = ANSI point code • <code>pci</code> = ITU-I or ITU-I spare point code • <code>pcn</code> = 14-bit ITU-N or 14-bit ITU-N spare point code • <code>pcn24</code> = 24-bit ITU-N point code. 2. The domain (ANSI or ITU) of the point code and GTT set must be the same, unless the ANSI/ITU SCCP Conversion feature is enabled. If the ANSI/ITU SCCP Conversion feature is enabled, a GTA may contain an ANSI point code and an ITU GTT set, or an ITU point code and an ANSI GTT set. The GTT sets can be specified with the <code>gttsn</code>, <code>optsn</code>, or <code>opcsn</code> parameters. The CROSS GTT set, a GTT set containing the NETDOM value CROSS, can be specified with either ANSI or ITU point codes, but can be specified only with the <code>gttsn</code> parameter. 3. If the VGTT feature is on, shown by the <code>VGTT = on</code> entry in the <code>rtrv-feat</code> output, and the GTT set name contains 10 different length GTAs, the length of the GTA must match any existing GTA assigned to the GTT set name. If the Support for 16 GTT Lengths for VGTT feature is enabled and turned on, shown by the <code>VGTT with 16 GTT lengths</code> entry in the <code>rtrv-ctrl-feat</code> output, and the GTT set name contains 16 different length GTAs, the length of the GTA must match any existing GTA assigned to the GTT set name. 4. If the GTT set name contains less than the maximum number of different length GTAs, the length of the GTA can be from 1 to 21 digits. 5. If the VGTT feature is off, the length of the GTA must contain the number of digits defined by the NDGT field of the <code>rtrv-gttset</code> output. 6. If the point code is the EAGLE's point code, then the <code>xlat</code> parameter value must be <code>dpcssn</code> and the <code>ri</code> parameter value must be <code>ssn</code>. 7. The <code>force</code> parameter can be specified only if the <code>ri</code> parameter is <code>ssn</code> and the <code>xlat</code> parameter value is <code>dpc</code>. If the <code>pc/pca/pci/pcn/pcn24</code> parameter value is not shown in the <code>rtrv-map</code> output, the <code>force=yes</code> parameter must be specified with the <code>ent-gta</code> command. 8. If the <code>ri</code> parameter value is <code>gt</code>, the <code>xlat</code> parameter value can be <code>dpcngt</code>, <code>dpcssn</code>, or <code>dpc</code>. If the <code>ri</code> parameter value is <code>ssn</code>, the <code>xlat</code> parameter value can be <code>dpcssn</code> or <code>dpc</code>. 9. the <code>ssn</code> parameter can be specified, and must be specified, only if the <code>xlat</code> parameter is <code>dpcssn</code>. 10. Hexadecimal digits (0-9, a-f, A-F) can be specified for the <code>gta</code> or <code>egta</code> parameters only if the Hex Digit support for GTT feature is enabled. 	

Table 4-26 GTTSN = CGGTA GTT Set Parameter Combinations

XLAT=DPCNGT, DPCSSN, or DPC	XLAT=NONE
Mandatory Parameters	

Table 4-26 (Cont.) GTTSN = CCGTA GTT Set Parameter Combinations

XLAT=DPCNGT, DPCSSN, or DPC	XLAT=NONE
<p>GTTSN – The GTT set name from the GTTSN column of the <code>rtrv-gttset</code> output containing the value CCGTA in the SETTYPE column.</p>	<p>GTTSN – The GTT set name from the GTTSN column of the <code>rtrv-gttset</code> output containing the value CCGTA in the SETTYPE column.</p>
<p>RI – GT, SSN (See Notes 6, 7, 8, and 9)</p>	<p>GTA – 1 - 21 digits or 1 - 21 hexadecimal digits (See Notes 3, 4, 5, and 10)</p>
<p>PC/PCA/PCI/PCN/PCN24 (See Notes 1, 2, and 6)</p>	
<p>GTA – 1 - 21 digits or 1 - 21 hexadecimal digits (See Notes 3, 4, 5, and 10)</p>	
Optional Parameters	
<p>SSN – 0 - 255. Default value – no SSN value is specified. (See Note 9)</p>	<p>EGTA – 1 - 21 digits or 1 - 21 hexadecimal digits. (See Note 10)</p> <p>Default = same as the GTA value.</p> <p>The length of the EGTA value must be the same as the GTA value. These parameters cannot be specified with the <code>xlat=none</code> parameter.</p> <ul style="list-style-type: none"> • <code>pc/pca/pci/pcn/pcn24</code> • <code>ssn</code> • <code>ri</code> • <code>force=yes</code>
<p>OPTSN – The GTT set name from the GTTSN column of the <code>rtrv-gttset</code> output. Refer to Table 4-23 for the valid GTT set types that can be specified. Default value – no GTT set is specified.</p>	
<p>There are other optional parameters that can be used with this entry. Refer to Table 4-33 for these parameters.</p>	

Table 4-26 (Cont.) GTTSN = CGGTA GTT Set Parameter Combinations

XLAT=DPCNGT, DPCSSN, or DPC	XLAT=NONE
Notes:	
<ol style="list-style-type: none"> 1. The <code>pc/pca/pci/pcn/pcn24</code> parameters are used to assign either ANSI, ITU-I, ITU-I spare, 14-bit ITU-N, 14-bit ITU-N spare, or 24-bit ITU-N point codes to the global title address (GTA). <ul style="list-style-type: none"> • <code>pc/pca</code> = ANSI point code • <code>pci</code> = ITU-I or ITU-I spare point code • <code>pcn</code> = 14-bit ITU-N or 14-bit ITU-N spare point code • <code>pcn24</code> = 24-bit ITU-N point code. 2. The domain (ANSI or ITU) of the point code and GTT set must be the same, unless the ANSI/ITU SCCP Conversion feature is enabled. If the ANSI/ITU SCCP Conversion feature is enabled, a GTA may contain an ANSI point code and an ITU GTT set, or an ITU point code and an ANSI GTT set. The GTT sets can be specified with the <code>gttsn</code>, <code>optsn</code>, or <code>opcsn</code> parameters. The CROSS GTT set, a GTT set containing the NETDOM value CROSS, can be specified with either ANSI or ITU point codes, but can be specified only with the <code>gttsn</code> parameter. 3. If the VGTT feature is on, shown by the <code>VGTT = on</code> entry in the <code>rtrv-feat</code> output, and the GTT set name contains 10 different length GTAs, the length of the GTA must match any existing GTA assigned to the GTT set name. If the Support for 16 GTT Lengths for VGTT feature is enabled and turned on, shown by the <code>VGTT with 16 GTT lengths</code> entry in the <code>rtrv-ctrl-feat</code> output, and the GTT set name contains 16 different length GTAs, the length of the GTA must match any existing GTA assigned to the GTT set name. 4. If the GTT set name contains less than the maximum number of different length GTAs, the length of the GTA can be from 1 to 21 digits. 5. If the VGTT feature is off, the length of the GTA must contain the number of digits defined by the NDGT field of the <code>rtrv-gttset</code> output. 6. If the point code is the EAGLE's point code, then the <code>xlat</code> parameter value must be <code>dpcssn</code> and the <code>ri</code> parameter value must be <code>ssn</code>. 7. The <code>force</code> parameter can be specified only if the <code>ri</code> parameter is <code>ssn</code> and the <code>xlat</code> parameter value is <code>dpc</code>. If the <code>pc/pca/pci/pcn/pcn24</code> parameter value is not shown in the <code>rtrv-map</code> output, the <code>force=yes</code> parameter must be specified with the <code>ent-gta</code> command. 8. If the <code>ri</code> parameter value is <code>gt</code>, the <code>xlat</code> parameter value can be <code>dpcngt</code>, <code>dpcssn</code>, or <code>dpc</code>. If the <code>ri</code> parameter value is <code>ssn</code>, the <code>xlat</code> parameter value can be <code>dpcssn</code> or <code>dpc</code>. 9. the <code>ssn</code> parameter can be specified, and must be specified, only if the <code>xlat</code> parameter is <code>dpcssn</code>. 10. Hexadecimal digits (0-9, a-f, A-F) can be specified for the <code>gta</code> or <code>egta</code> parameters only if the Hex Digit support for GTT feature is enabled. 	

Table 4-27 GTTSN = CGPC GTT Set Parameter Combinations

XLAT=DPCNGT, DPCSSN, or DPC	XLAT=NONE
Mandatory Parameters	

Table 4-27 (Cont.) GTTSN = CGPC GTT Set Parameter Combinations

XLAT=DPCNGT, DPCSSN, or DPC	XLAT=NONE
GTTSN – The GTT set name from the GTTSN column of the <code>rtrv-gttset</code> output containing the value CGPC in the SETTYPE column.	GTTSN – The GTT set name from the GTTSN column of the <code>rtrv-gttset</code> output containing the value CGPC in the SETTYPE column.
RI – GT, SSN (See Notes 3, 4, 5, and 6)	CGPC/CGPCA/CGPCI/CGPCN/CGPCN24 (See Notes 1, 2, and 3)
PC/PCA/PCI/PCN/PCN24 (See Notes 1, 2, and 3)	
CGPC/CGPCA/CGPCI/CGPCN/CGPCN24 (See Notes 1, 2, and 3)	
Optional Parameters	
SSN – 0 - 255. Default value – no SSN value is specified. (See Note 3)	<p>These parameters cannot be specified with the <code>xlat=none</code> parameter.</p> <ul style="list-style-type: none"> • <code>pc/pca/pci/pcn/pcn24</code> • <code>ssn</code> • <code>ri</code> • <code>force=yes</code>
OPTSN – The GTT set name from the GTTSN column of the <code>rtrv-gttset</code> output. Refer to Table 4-23 for the valid GTT set types that can be specified. Default value – no GTT set is specified.	
There are other optional parameters that can be used with this entry. Refer to Table 4-33 for these parameters. The EGTA parameter cannot be specified with this entry.	

Table 4-27 (Cont.) GTTSN = CGPC GTT Set Parameter Combinations

XLAT=DPCNGT, DPCSSN, or DPC	XLAT=NONE
Notes:	
<ol style="list-style-type: none"> The <i>pc/pca/pci/pcn/pcn24</i> parameters are used to assign either ANSI, ITU-I, ITU-I spare, 14-bit ITU-N, 14-bit ITU-N spare, or 24-bit ITU-N point codes as the translated point code. The <i>cgpc/cgpca/cgpci/cgpcn/cgpcn24</i> parameters are used to assign either ANSI, ITU-I, ITU-I spare, 14-bit ITU-N, 14-bit ITU-N spare, or 24-bit ITU-N point codes as the CGPC parameter values. <ul style="list-style-type: none"> <i>pc/pca</i> and <i>cgpca</i> = ANSI point code <i>pci</i> and <i>cgpci</i> = ITU-I or ITU-I spare point code <i>pcn</i> and <i>cgpcn</i> = 14-bit ITU-N or 14-bit ITU-N spare point code <i>pcn24</i> and <i>cgpcn24</i> = 24-bit ITU-N point code. The domain (ANSI or ITU) of the point code and GTT set must be the same, unless the ANSI/ITU SCCP Conversion feature is enabled. If the ANSI/ITU SCCP Conversion feature is enabled, a GTA may contain an ANSI point code and an ITU GTT set, or an ITU point code and an ANSI GTT set. The GTT sets can be specified with the <i>gttsn</i>, <i>optsn</i>, or <i>opcsn</i> parameters. The CROSS GTT set, a GTT set containing the NETDOM value CROSS, can be specified with either ANSI or ITU point codes, but can be specified only with the <i>gttsn</i> parameter. If the point code is the EAGLE's point code, then the <i>xlat</i> parameter value must be <i>dpcssn</i> and the <i>ri</i> parameter value must be <i>ssn</i>. The <i>force</i> parameter can be specified only if the <i>ri</i> parameter is <i>ssn</i> and the <i>xlat</i> parameter value is <i>dpc</i>. If the <i>pc/pca/pci/pcn/pcn24</i> parameter value is not shown in the <i>rtrv-map</i> output, the <i>force=yes</i> parameter must be specified with the <i>ent-gta</i> command. If the <i>ri</i> parameter value is <i>gt</i>, the <i>xlat</i> parameter value can be <i>dpcngt</i>, <i>dpcssn</i>, or <i>dpc</i>. If the <i>ri</i> parameter value is <i>ssn</i>, the <i>xlat</i> parameter value can be <i>dpcssn</i> or <i>dpc</i>. the <i>ssn</i> parameter can be specified, and must be specified, only if the <i>xlat</i> parameter is <i>dpcssn</i>. 	

Table 4-28 GTTSN = CGSSN GTT Set Parameter Combinations

XLAT=DPCNGT, DPCSSN, or DPC	XLAT=NONE
Mandatory Parameters	
GTTSN – The GTT set name from the GTTSN column of the <i>rtrv-gttset</i> output containing the value CGSSN in the SETTYPE column.	GTTSN – The GTT set name from the GTTSN column of the <i>rtrv-gttset</i> output containing the value CGSSN in the SETTYPE column.
RI = GT, SSN (See Notes 3, 4, 5, and 6)	CGSSN – 0 - 255
PC/PCA/PCI/PCN/PCN24 (See Notes 1, 2, and 3)	
CGSSN – 0 - 255	
Optional Parameters	

Table 4-28 (Cont.) GTTSN = CGSSN GTT Set Parameter Combinations

XLAT=DPCNGT, DPCSSN, or DPC	XLAT=NONE
<p>SSN – 0 - 255. Default value – no SSN value is specified. (See Note 3)</p>	<p>ECGSSN – 0 - 255. Default value – no ECGSSN value is specified. The ECGSSN value must be greater than the CGSSN value.</p> <p>These parameters cannot be specified with the <code>xlat=none</code> parameter.</p> <ul style="list-style-type: none"> • <code>pc/pca/pci/pcn/pcn24</code> • <code>ssn</code> • <code>ri</code> • <code>force=yes</code>
<p>ECGSSN – 0 - 255. Default value – no ECGSSN value is specified. The ECGSSN value must be greater than the CGSSN value.</p>	
<p>OPTSN – The GTT set name from the GTTSN column of the <code>rtrv-gttset</code> output. Refer to Table 4-23 for the valid GTT set types that can be specified. Default value – no GTT set is specified.</p>	
<p>There are other optional parameters that can be used with this entry. Refer to Table 4-33 for these parameters. The EGTA parameter cannot be specified with this entry.</p>	
<p>Notes:</p>	
<ol style="list-style-type: none"> 1. The <code>pc/pca/pci/pcn/pcn24</code> parameters are used to assign either ANSI, ITU-I, ITU-I spare, 14-bit ITU-N, 14-bit ITU-N spare, or 24-bit ITU-N point codes as the translated point code. <ul style="list-style-type: none"> • <code>pc/pca</code> = ANSI point code • <code>pci</code> = ITU-I or ITU-I spare point code • <code>pcn</code> = 14-bit ITU-N or 14-bit ITU-N spare point code • <code>pcn24</code> = 24-bit ITU-N point code. 2. The domain (ANSI or ITU) of the point code and GTT set must be the same, unless the ANSI/ITU SCCP Conversion feature is enabled. If the ANSI/ITU SCCP Conversion feature is enabled, a GTA may contain an ANSI point code and an ITU GTT set, or an ITU point code and an ANSI GTT set. The GTT sets can be specified with the <code>gttsn</code>, <code>optsn</code>, or <code>opcssn</code> parameters. The CROSS GTT set, a GTT set containing the NETDOM value CROSS, can be specified with either ANSI or ITU point codes, but can be specified only with the <code>gttsn</code> parameter. 3. If the point code is the EAGLE's point code, then the <code>xlat</code> parameter value must be <code>dpcssn</code> and the <code>ri</code> parameter value must be <code>ssn</code>. 4. The <code>force</code> parameter can be specified only if the <code>ri</code> parameter is <code>ssn</code> and the <code>xlat</code> parameter value is <code>dpc</code>. If the <code>pc/pca/pci/pcn/pcn24</code> parameter value is not shown in the <code>rtrv-map</code> output, the <code>force=yes</code> parameter must be specified with the <code>ent-gta</code> command. 5. If the <code>ri</code> parameter value is <code>gt</code>, the <code>xlat</code> parameter value can be <code>dpcngt</code>, <code>dpcssn</code>, or <code>dpc</code>. If the <code>ri</code> parameter value is <code>ssn</code>, the <code>xlat</code> parameter value can be <code>dpcssn</code> or <code>dpc</code>. 6. the <code>ssn</code> parameter can be specified, and must be specified, only if the <code>xlat</code> parameter is <code>dpcssn</code>. 	

Table 4-29 GTTSN = OPC GTT Set Parameter Combinations

XLAT=DPCNGT, DPCSSN, or DPC	XLAT=NONE
Mandatory Parameters	
GTTSN – The GTT set name from the GTTSN column of the <code>rtrv-gttset</code> output containing the value OPC in the SETTYPE column.	GTTSN – The GTT set name from the GTTSN column of the <code>rtrv-gttset</code> output containing the value OPC in the SETTYPE column.
RI – GT, SSN (See Notes 3, 4, 5, and 6)	OPC/OPCA/OPCI/OPCN/OPCN24 (See Notes 1, 2, and 3)
PC/PCA/PCI/PCN/PCN24 (See Notes 1, 2, and 3)	
OPC/OPCA/OPCI/OPCN/OPCN24 (See Notes 1, 2, and 3)	
Optional Parameters	
SSN – 0 - 255. Default value – no SSN value is specified. (See Note 3)	These parameters cannot be specified with the <code>xlat=none</code> parameter. <ul style="list-style-type: none"> • <code>pc/pca/pci/pcn/pcn24</code> • <code>ssn</code> • <code>ri</code> • <code>force=yes</code>
OPTSN – The GTT set name from the GTTSN column of the <code>rtrv-gttset</code> output. Refer to Table 4-23 for the valid GTT set types that can be specified. Default value – no GTT set is specified.	
There are other optional parameters that can be used with this entry. Refer to Table 4-33 for these parameters. The EGTA parameter cannot be specified with this entry.	

Table 4-29 (Cont.) GTTSN = OPC GTT Set Parameter Combinations

XLAT=DPCNGT, DPCSSN, or DPC	XLAT=NONE
Notes:	
<ol style="list-style-type: none"> the <i>pc/pca/pci/pcn/pcn24</i> parameters are used to assign either ANSI, ITU-I, ITU-I spare, 14-bit ITU-N, 14-bit ITU-N spare, or 24-bit ITU-N point codes as the translated point code. the <i>opc/opca/opci/opcn/opcn24</i> parameters are used to assign either ANSI, ITU-I, ITU-I spare, 14-bit ITU-N, 14-bit ITU-N spare, or 24-bit ITU-N point codes as the OPC parameter values. <ul style="list-style-type: none"> <i>pc/pca</i> and <i>opc/opca</i> = ANSI point code <i>pci</i> and <i>opci</i> = ITU-I or ITU-I spare point code <i>pcn</i> and <i>opcn</i> = 14-bit ITU-N or 14-bit ITU-N spare point code <i>pcn24</i> and <i>opcn24</i> = 24-bit ITU-N point code. The domain (ANSI or ITU) of the point code and GTT set must be the same, unless the ANSI/ITU SCCP Conversion feature is enabled. If the ANSI/ITU SCCP Conversion feature is enabled, a GTA may contain an ANSI point code and an ITU GTT set, or an ITU point code and an ANSI GTT set. The GTT sets can be specified with the <i>gttsn</i>, <i>optsn</i>, or <i>opcsn</i> parameters. The CROSS GTT set, a GTT set containing the NETDOM value CROSS, can be specified with either ANSI or ITU point codes, but can be specified only with the <i>gttsn</i> parameter. If the point code is the EAGLE's point code, then the <i>xlat</i> parameter value must be <i>dpcssn</i> and the <i>ri</i> parameter value must be <i>ssn</i>. The <i>force</i> parameter can be specified only if the <i>ri</i> parameter is <i>ssn</i> and the <i>xlat</i> parameter value is <i>dpc</i>. If the <i>pc/pca/pci/pcn/pcn24</i> parameter value is not shown in the <i>rtrv-map</i> output, the <i>force=yes</i> parameter must be specified with the <i>ent-gta</i> command. If the <i>ri</i> parameter value is <i>gt</i>, the <i>xlat</i> parameter value can be <i>dpcngt</i>, <i>dpcssn</i>, or <i>dpc</i>. If the <i>ri</i> parameter value is <i>ssn</i>, the <i>xlat</i> parameter value can be <i>dpcssn</i> or <i>dpc</i>. the <i>ssn</i> parameter can be specified, and must be specified, only if the <i>xlat</i> parameter is <i>dpcssn</i>. 	

Table 4-30 GTTSN = CDSSN GTT Set Parameter Combinations

XLAT=DPCNGT, DPCSSN, or DPC	XLAT=NONE
Mandatory Parameters	
GTTSN – The GTT set name from the GTTSN column of the <i>rtrv-gttset</i> output containing the value CDSSN in the SETTYPE column.	GTTSN – The GTT set name from the GTTSN column of the <i>rtrv-gttset</i> output containing the value CDSSN in the SETTYPE column.
RI = GT, SSN (See Notes 3, 4, 5, and 6)	CDSSN – 0 - 255
PC/PCA/PCI/PCN/PCN24 (See Notes 1, 2, and 3)	
CDSSN – 0 - 255	
Optional Parameters	

Table 4-30 (Cont.) GTTSN = CDSSN GTT Set Parameter Combinations

XLAT=DPCNGT, DPCSSN, or DPC	XLAT=NONE
<p>SSN – 0 - 255. Default value – no SSN value is specified. (See Note 3)</p>	<p>ECDSSN – 0 - 255. Default value – no ECDSSN value is specified. The ECDSSN value must be greater than the CDSSN value.</p> <p>These parameters cannot be specified with the <code>xlat=none</code> parameter.</p> <ul style="list-style-type: none"> • <code>pc/pca/pci/pcn/pcn24</code> • <code>ssn</code> • <code>ri</code> • <code>force=yes</code>
<p>ECDSSN – 0 - 255. Default value – no ECDSSN value is specified. The ECDSSN value must be greater than the CDSSN value.</p>	
<p>OPTSN – The GTT set name from the GTTSN column of the <code>rtrv-gttset</code> output. Refer to Table 4-23 for the valid GTT set types that can be specified. Default value – no GTT set is specified.</p>	
<p>OPCSN – The GTT set name from the GTTSN column of the <code>rtrv-gttset</code> output containing the value OPC in the SETTYPE column. Default value – no OPC GTT set is specified.</p>	
<p>There are other optional parameters that can be used with this entry. Refer to Table 4-33 for these parameters. The EGTA parameter cannot be specified with this entry.</p>	

Table 4-30 (Cont.) GTTSN = CDSSN GTT Set Parameter Combinations

XLAT=DPCNGT, DPCSSN, or DPC	XLAT=NONE
Notes:	
<ol style="list-style-type: none"> The <code>pc/pca/pci/pcn/pcn24</code> parameters are used to assign either ANSI, ITU-I, ITU-I spare, 14-bit ITU-N, 14-bit ITU-N spare, or 24-bit ITU-N point codes as the translated point code. <ul style="list-style-type: none"> <code>pc/pca</code> = ANSI point code <code>pci</code> = ITU-I or ITU-I spare point code <code>pcn</code> = 14-bit ITU-N or 14-bit ITU-N spare point code <code>pcn24</code> = 24-bit ITU-N point code. The domain (ANSI or ITU) of the point code and GTT set must be the same, unless the ANSI/ITU SCCP Conversion feature is enabled. If the ANSI/ITU SCCP Conversion feature is enabled, a GTA may contain an ANSI point code and an ITU GTT set, or an ITU point code and an ANSI GTT set. The GTT sets can be specified with the <code>gttsn</code>, <code>optsn</code>, or <code>opcsn</code> parameters. The CROSS GTT set, a GTT set containing the NETDOM value CROSS, can be specified with either ANSI or ITU point codes, but can be specified only with the <code>gttsn</code> parameter. If the point code is the EAGLE's point code, then the <code>xlat</code> parameter value must be <code>dpcssn</code> and the <code>ri</code> parameter value must be <code>ssn</code>. the <code>force</code> parameter can be specified only if the <code>ri</code> parameter is <code>ssn</code> and the <code>xlat</code> parameter value is <code>dpc</code>. If the <code>pc/pca/pci/pcn/pcn24</code> parameter value is not shown in the <code>rtrv-map</code> output, the <code>force=yes</code> parameter must be specified with the <code>ent-gta</code> command. If the <code>ri</code> parameter value is <code>gt</code>, the <code>xlat</code> parameter value can be <code>dpcngt</code>, <code>dpcssn</code>, or <code>dpc</code>. If the <code>ri</code> parameter value is <code>ssn</code>, the <code>xlat</code> parameter value can be <code>dpcssn</code> or <code>dpc</code>. the <code>ssn</code> parameter can be specified, and must be specified, only if the <code>xlat</code> parameter is <code>dpcssn</code>. 	

Table 4-31 GTTSN = OPCODE GTT Set Parameter Combinations

XLAT=DPCNGT, DPCSSN, or DPC	XLAT=NONE	
Mandatory Parameters		
GTTSN – The GTT set name from the GTTSN column of the <code>rtrv-gttset</code> output containing the value OPCODE in the SETTYPE column.	GTTSN – The GTT set name from the GTTSN column of the <code>rtrv-gttset</code> output containing the value OPCODE in the SETTYPE column.	
RI = GT, SSN (See Notes 3, 4, 5, and 6)	OPCODE – 0 - 255, *, none	
PC/PCA/PCI/PCN/PCN24 (See Notes 1, 2, and 3)	ANSI TCAP Translation	ITU TCAP Translation
OPCODE – See Notes 7, 10, and 11	FAMILY – See Notes 8, 10, and 11	ACN – The application context name – See Notes 9 and 10
ANSI TCAP Translation	ITU TCAP Translation	PKGTYPE – any, bgn, cnt, end, ituabort, ituumi
	PKGTYPE – ansiabort, ansiumi, any, cwop, cwp, qwop, qwp, resp	

Table 4-31 (Cont.) GTTSN = OPCODE GTT Set Parameter Combinations

XLAT=DPCNGT, DPCSSN, or DPC	XLAT=NONE
FAMILY – See Notes 8, 10, and 11	ACN – The application context name – See Notes 9 and 10
PKGTYPE – ansiabort, ansiumi, any, cwop, cwp, qwop, qwp, resp	PKGTYPE – any, bgn, cnt, end, ituabort, ituumi
Optional Parameters	
SSN – 0 - 255. Default value – no SSN value is specified. (See Note 3)	These parameters cannot be specified with the <code>xlat=none</code> parameter. <ul style="list-style-type: none"> • <code>pc/pca/pci/pcn/pcn24</code> • <code>ssn</code> • <code>ri</code> • <code>force=yes</code>
OPTSN – The GTT set name from the GTTSN column of the <code>rtrv-gttset</code> output. Refer to Table 4-23 for the valid GTT set types that can be specified. Default value – no GTT set is specified.	
OPCSN – The GTT set name from the GTTSN column of the <code>rtrv-gttset</code> output containing the value OPC in the SETTYPE column. Default value – no OPC GTT set is specified.	
There are other optional parameters that can be used with this entry. Refer to Table 4-33 for these parameters. The EGTA parameter cannot be specified with this entry.	

Table 4-31 (Cont.) GTTSN = OPCODE GTT Set Parameter Combinations

XLAT=DPCNGT, DPCSSN, or DPC	XLAT=NONE
Notes:	
<ol style="list-style-type: none"> 1. the <code>pc/pca/pci/pcn/pcn24</code> parameters are used to assign either ANSI, ITU-I, ITU-I spare, 14-bit ITU-N, 14-bit ITU-N spare, or 24-bit ITU-N point codes as the translated point code. <ul style="list-style-type: none"> • <code>pc/pca</code> = ANSI point code • <code>pci</code> = ITU-I or ITU-I spare point code • <code>pcn</code> = 14-bit ITU-N or 14-bit ITU-N spare point code • <code>pcn24</code> = 24-bit ITU-N point code. 2. The domain (ANSI or ITU) of the point code and GTT set must be the same, unless the ANSI/ITU SCCP Conversion feature is enabled. If the ANSI/ITU SCCP Conversion feature is enabled, a GTA may contain an ANSI point code and an ITU GTT set, or an ITU point code and an ANSI GTT set. The GTT sets can be specified with the <code>gttsn</code>, <code>optsn</code>, or <code>opcsn</code> parameters. The CROSS GTT set, a GTT set containing the NETDOM value CROSS, can be specified with either ANSI or ITU point codes, but can be specified only with the <code>gttsn</code> parameter. 3. If the point code is the EAGLE's point code, then the <code>xlat</code> parameter value must be <code>dpcssn</code> and the <code>ri</code> parameter value must be <code>ssn</code>. 4. The <code>force</code> parameter can be specified only if the <code>ri</code> parameter is <code>ssn</code> and the <code>xlat</code> parameter value is <code>dpc</code>. If the <code>pc/pca/pci/pcn/pcn24</code> parameter value is not shown in the <code>rtrv-map</code> output, the <code>force=yes</code> parameter must be specified with the <code>ent-gta</code> command. 5. If the <code>ri</code> parameter value is <code>gt</code>, the <code>xlat</code> parameter value can be <code>dpcngt</code>, <code>dpcssn</code>, or <code>dpc</code>. If the <code>ri</code> parameter value is <code>ssn</code>, the <code>xlat</code> parameter value can be <code>dpcssn</code> or <code>dpc</code>. 6. The <code>ssn</code> parameter can be specified, and must be specified, only if the <code>xlat</code> parameter is <code>dpcssn</code>. 7. The <code>opcode</code> parameter value is one of these values. <ul style="list-style-type: none"> • the number 0 to 255 • * - any valid value in the TCAP OPCODE field in the incoming MSU • none - there is no value in the TCAP OPCODE field in the incoming MSU 8. The <code>family</code> parameter value is one of these values. <ul style="list-style-type: none"> • The number 0 to 255 • * - any valid value in the ANSI TCAP FAMILY field in the incoming MSU • none - there is no value in the ANSI TCAP FAMILY field in the incoming MSU 9. The <code>acn</code> parameter value is one of these values. <ul style="list-style-type: none"> • a maximum of 7 subfields containing the numbers 0 to 255 separated by dash (for example, 1-202-33-104-54-26-007) • * - any valid value in the ITU TCAP ACN field in the incoming MSU • none - there is no value in the ITU TCAP ACN field in the incoming MSU 10. If the <code>pkgtype=ituabort</code> parameter is specified, the value <code>none</code> must be specified for the <code>acn</code> and <code>opcode</code> parameters. If the <code>pkgtype=ansiabort</code> parameter is specified, the value <code>none</code> must be specified for the <code>family</code> and <code>opcode</code> parameters. 11. If the value <code>none</code> is specified for either the <code>family</code> or <code>opcode</code> parameters, the value <code>none</code> must be specified for both parameters. 	

Table 4-32 GTTSN = DPC GTT Set Parameter Combinations

XLAT=DPCNGT, DPCSSN, or DPC	XLAT=NONE
Mandatory Parameters	
GTTSN – The GTT set name from the GTTSN column of the <code>rtrv-gttset</code> output containing the value DPC in the SETTYPE column.	GTTSN – The GTT set name from the GTTSN column of the <code>rtrv-gttset</code> output containing the value DPC in the SETTYPE column.
RI – GT, SSN (See Notes 3, 4, 5, and 6)	DPC/DPCA/DPCI/DPCN/DPCN24 (See Notes 1, 2, and 3)
PC/PCA/PCI/PCN/PCN24 (See Notes 1, 2, and 3)	
DPC/DPCA/DPCI/DPCN/DPCN24 (See Notes 1, 2, and 3)	
Optional Parameters	
SSN – 0 - 255. Default value – no SSN value is specified. (See Note 3)	These parameters cannot be specified with the <code>xlat=none</code> parameter. <ul style="list-style-type: none"> • <code>pc/pca/pci/pcn/pcn24</code> • <code>ssn</code> • <code>ri</code> • <code>force=yes</code>
OPTSN – The GTT set name from the GTTSN column of the <code>rtrv-gttset</code> output. Refer to Table 4-23 for the valid GTT set types that can be specified. Default value – no GTT set is specified.	
There are other optional parameters that can be used with this entry. Refer to Table 4-33 for these parameters. The EGTA parameter cannot be specified with this entry.	

Table 4-32 (Cont.) GTTSN = DPC GTT Set Parameter Combinations

XLAT=DPCNGT, DPCSSN, or DPC	XLAT=NONE
Notes:	
<ol style="list-style-type: none"> the <code>pc/pca/pci/pcn/pcn24</code> parameters are used to assign either ANSI, ITU-I, ITU-I spare, 14-bit ITU-N, 14-bit ITU-N spare, or 24-bit ITU-N point codes as the translated point code. the <code>dpc/dpca/dpci/dpcn/dpcn24</code> parameters are used to assign either ANSI, ITU-I, ITU-I spare, 14-bit ITU-N, 14-bit ITU-N spare, or 24-bit ITU-N point codes as the DPC parameter values. <ul style="list-style-type: none"> <code>pc/pca</code> and <code>dpc/dpca</code> = ANSI point code <code>pci</code> and <code>dpci</code> = ITU-I or ITU-I spare point code <code>pcn</code> and <code>dpcn</code> = 14-bit ITU-N or 14-bit ITU-N spare point code <code>pcn24</code> and <code>dpcn24</code> = 24-bit ITU-N point code. The domain (ANSI or ITU) of the point code and GTT set must be the same, unless the ANSI/ITU SCCP Conversion feature is enabled. If the ANSI/ITU SCCP Conversion feature is enabled, a GTA may contain an ANSI point code and an ITU GTT set, or an ITU point code and an ANSI GTT set. The GTT sets can be specified with the <code>gttsn</code>, <code>optsn</code>, or <code>opcsn</code> parameters. The CROSS GTT set, a GTT set containing the NETDOM value CROSS, can be specified with either ANSI or ITU point codes, but can be specified only with the <code>gttsn</code> parameter. If the point code is the EAGLE's point code, then the <code>xlat</code> parameter value must be <code>dpcssn</code> and the <code>ri</code> parameter value must be <code>ssn</code>. the <code>force</code> parameter can be specified only if the <code>ri</code> parameter is <code>ssn</code> and the <code>xlat</code> parameter value is <code>dpc</code>. If the <code>pc/pca/pci/pcn/pcn24</code> parameter value is not shown in the <code>rtrv-map</code> output, the <code>force=yes</code> parameter must be specified with the <code>ent-gta</code> command. If the <code>ri</code> parameter value is <code>gt</code>, the <code>xlat</code> parameter value can be <code>dpcngt</code>, <code>dpcssn</code>, or <code>dpc</code>. If the <code>ri</code> parameter value is <code>ssn</code>, the <code>xlat</code> parameter value can be <code>dpcssn</code> or <code>dpc</code>. the <code>ssn</code> parameter can be specified, and must be specified, only if the <code>xlat</code> parameter is <code>dpcssn</code>. 	

Table 4-33 Optional GTA Parameters

EGTA – 1 - 21 digits or 1 - 21 hexadecimal digits. Default = same as the GTA value. Hexadecimal digits (0-9, a-f, A-F) can be specified for the `egta` parameter only if the Hex Digit support for GTT feature is enabled.

MRNSET – MRN set ID from the `rtrv-mrn` output. The `mrnset` parameter can be specified only, and must be specified, if the Flexible GTT Load Sharing feature is enabled.

LOOPSET – Loopset name from the `rtrv-loopset` output. The `loopset` parameter can be specified only if the SCCP Loop Detection feature is enabled.

CGGTMOD – yes, no. Default = no. The `cggtmod` parameter can be specified only if the AMGTT or AMGTT CgPA Upgrade feature is enabled.

CCGT – yes, no. Default = no. If the point code is the EAGLE's point code, then the value of the `ccgt` parameter must be set to no.

MAPSET – MAP set ID from the `rtrv-map` output. The `mapset` parameter can be specified only, and must be specified, if the Flexible GTT Load Sharing feature is enabled.

FORCE – yes, no. Default = no. If the `pc/pca/pci/pcn/pcn24` parameter value is not shown in the `rtrv-map` output, the `force=yes` parameter must be specified with the `ent-gta` command.

Table 4-33 (Cont.) Optional GTA Parameters

TESTMODE – on, off. Default = off.

FALLBACK – sysdflt, yes, no. Default = sysdflt. The Flexible Linkset Optional Based Routing feature must be enabled and turned on to use this parameter.

CGSELID – 0 - 65534. Default = no CGSELID value is specified. The Origin-Based SCCP Routing feature must be enabled or the Flexible Linkset Optional Based Routing feature must be enabled and turned on to use this parameter.

CDSELID – 0 - 65534. Default = no CDSELID value is specified. The Flexible Linkset Optional Based Routing feature must be enabled and turned on to use this parameter.

CGCNVSN – GTT set name shown in the `rtrv-gttset` output. Default = no CGCNVSN value is specified. The ANSI/ITU SCCP Conversion feature must be enabled, and the Flexible Linkset Optional Based Routing feature must be enabled and turned on to use this parameter.

ACTSN – The name of the GTT action set name shown in the `rtrv-gttset` output. Default = no ACTSN value is specified. The `actsn` parameter can be specified only if the GTT Action - DISCARD, GTT Action - DUPLICATE, GTT Action - FORWARD feature is enabled.

GTMODID – The name of the GT modification identifier shown in the `rtrv-gtmod` output. Default = no GTMODID value is specified. If the NGTI value in the global title modification entry is 4, the point code that will be assigned to the GTA entry must be an ITU point code.

PPMEASREQD – This parameter specifies whether per-path measurements are required for the GTA entry. This parameter has two values.

- yes - per-path measurements are required for the GTA entry.
- no - per-path measurements are not required for the GTA entry.

1. Display the existing GTT sets in the database using the `rtrv-gttset` command.

This is an example of the possible output.

```
r1ghncxa03w 09-07-07 00:29:31 GMT EAGLE5 41.1.0
```

GTTSN	NETDOM	SETTYPE	NDGT
abcd1234	itu	CGGTA	12
imsi	itu	CDGTA	15
lidb	ansi	CDGTA	10
t800	ansi	CGGTA	6
s1000	itu	CDGTA	15
s2000	itu	CGPC	-

GTT-SET table is (6 of 2000) 1% full.

If the desired GTT set name is shown in the `rtrv-gttset` output, continue the procedure with [2](#).

If the desired GTT set name is not shown in the `rtrv-gttset` output, perform [Adding a GTT Set](#) to add the required GTT set. After the GTT set has been added, continue the procedure with [3](#). If the `SETTYPE` column is not shown in the `rtrv-gttset` output and you wish to provision the GTA entry for any of these features, Origin-Based SCCP Routing, Flexible Linkset Optional Based Routing, or TCAP Opcode Based Routing, make sure the appropriate feature is enabled, and turned on if necessary, when adding the GTT set. After the GTT set has been added, continue the procedure with [3](#).

2. Display the global title address information for the GTT set that the global title address information will be added to using the `rtrv-gta` command with the `gttsn` parameter value shown in the output of 1.

If the `num` parameter is specified with the `rtrv-gta` command, and the value of the `num` parameter is greater than 1000, the `force=yes` parameter must be specified with the `rtrv-gta` command. For this example, enter this command.

```
rtrv-gta:gttsn=t800
```

This is an example of the possible output.

```
rlghncxa03w 10-07-07 00:27:31 GMT EAGLE5 42.0.0
```

```
GTTSN      NETDOM  SETTYPE  NDGT
t800      ansi    CDGTA    10
GTA TABLE IS  1 % FULL (17 of 269999)

START GTA  END GTA   XLAT  RI    PC
8005550000 8005551999 DPCSSN SSN   001-254-255
      SSN=255 CCGT=no CGGTMOD=NO
      GTMODID=----- TESTMODE=off
      OPTSN=gttset7  CGSELID=----- OPCS=-----
      ACTSN=----- PPMEASREQD= NO
8005552000 8005553999 DPC    GT    001-254-255
      SSN=255 CCGT=no CGGTMOD=NO
      GTMODID=----- TESTMODE=off
      OPTSN=gttset7  CGSELID=----- OPCS=-----
      ACTSN=----- PPMEASREQD= NO
8005554000 8005555999 DPCNGT GT    001-254-255
      SSN=255 CCGT=no CGGTMOD=NO
      GTMODID=modid2  TESTMODE=off
      OPTSN=----- CGSELID=----- OPCS=gttset12
      ACTSN=----- PPMEASREQD= NO
8005556000 8005557999 DPCSSN SSN   001-254-255
      SSN=255 CCGT=no CGGTMOD=NO
      GTMODID=----- TESTMODE=off
      OPTSN=----- CGSELID=----- OPCS=gttset6
      ACTSN=----- PPMEASREQD= NO
8005558000 8005559999 DPCSSN SSN   001-254-255
      SSN=255 CCGT=yes CGGTMOD=NO
      GTMODID=----- TESTMODE=off
      OPTSN=----- CGSELID=----- OPCS=gttset12
      ACTSN=----- PPMEASREQD= NO
9195551212 9195551212 DPCSSN SSN   008-001-001
      SSN=222 CCGT=no CGGTMOD=NO
      GTMODID=----- TESTMODE=off
      OPTSN=----- CGSELID=----- OPCS=gttset12
      ACTSN=----- PPMEASREQD= NO
9762428487 9762428487 DPCSSN SSN   001-254-255
      SSN=222 CCGT=no CGGTMOD=NO
      GTMODID=----- TESTMODE=off
      OPTSN=----- CGSELID=----- OPCS=-----
      ACTSN=----- PPMEASREQD= NO
9766423277 9766423277 DPCSSN SSN   001-254-255
      SSN=222 CCGT=no CGGTMOD=NO
```

```

GTMODID=----- TESTMODE=off
OPTSN=----- CGSELID=----- OPCSN=-----
ACTSN=----- PPMEASREQD= NO
9769388928 9769388928 DPCSSN SSN 001-254-255
SSN=222 CCGT=no CGGTMOD=NO
GTMODID=----- TESTMODE=off
OPTSN=gttset9 CGSELID=----- OPCSN=-----
ACTSN=----- PPMEASREQD= NO

```

Command Retrieved 9 Entries

- The global title address entry cannot be added to the database if the database contains the maximum number of global title addresses the EAGLE is allowed to have. The maximum number of global title addresses is shown in the `rtrv-ctrl-feat` output.

The following is an example of the possible output.

```

rlghncxa03w 09-05-28 21:15:37 GMT EAGLE5 41.0.0
The following features have been permanently enabled:

```

Feature Name	Partnum	Status	Quantity
XGTT Table Expansion	893006101	on	400000
IPGWx Signaling TPS	893012814	on	20000
ISUP Normalization	893000201	on	----
Command Class Management	893005801	on	----
LNP Short Message Service	893006601	on	----
Intermed GTT Load Sharing	893006901	on	----
HC-MIM SLK Capacity	893012707	on	64

The following features have been temporarily enabled:

Feature Name	Partnum	Status	Quantity	Trial
Period Left				
Zero entries found.				

The following features have expired temporary keys:

Feature Name	Partnum
Zero entries found.	

 **Note:**

If the entry XGTT Table Expansion is not shown in the `rtrv-ctrl-feat` output, the maximum number of global title addresses that the database can contain is 269,999.

If the current number of global title translations that can be provisioned is 400,000, and the global title translation being added increases the number beyond 400,000 (the current number of global title translations that are provisioned is shown in the `rtrv-gta` output in 2), perform [Enabling the XGTT Table Expansion Feature](#) to enable XGTT Table Expansion feature for 1,000,000 global title translations.

If the current number of global title translations that can be provisioned is 269,999, and the global title translations being added increases the number beyond 269,999 (the current number of global title translations that are provisioned is shown in the `rtrv-gta` output in 2), perform [Enabling the XGTT Table Expansion Feature](#) to enable XGTT Table Expansion feature for 400,000 global title translations.

If the maximum number of global title is either 269,999 or 400,000, and the global title translation being added will not increase the number beyond the maximum number of global title translations (shown in the `rtrv-gta` output in 2), the maximum number of global title translations does not need to be increased. If the maximum number of global title translations is 1,000,000, the maximum number of global title translations cannot be increased.

4. Some parameters of the `ent-gta` command can be specified only when certain features are enabled, and turned on if necessary. [Table 4-34](#) shows the feature requirements for these parameters.

Table 4-34 Feature Requirements for ENT-GTA Parameters

Required Feature	Parameters or Values
Origin-Based SCCP Routing Enabled	GTTSN - specifying CGGTA, CGPC, CGSSN, or OPC GTT sets OPTSN - specifying CGGTA, CGPC, or CGSSN GTT sets OPCSN CGPC CGSSN ECGSSN OPC CGSELID
Flexible GTT Load Sharing Enabled	MAPSET MRNSET
Flexible Linkset Optional Based Routing Enabled and Turned On	GTTSN - specifying CDSSN or DPC GTT sets OPTSN - specifying CDSSN or DPC GTT sets FALLBACK CDSSN ECDSSN CDSELID DPC
ANSI/ITU SCCP Conversion Enabled and Flexible Linkset Optional Based Routing Enabled and Turned On	CGCNVSN
TCAP Opcode Based Routing Enabled and Turned On	GTTSN - specifying OPCODE GTT sets OPTSN - specifying OPCODE GTT sets
TOBR Quantity Enabled	ACN FAMILY OPCODE PKGTYPE
SCCP Loop Detection Enabled	LOOPSET

Table 4-34 (Cont.) Feature Requirements for ENT-GTA Parameters

Required Feature	Parameters or Values
Advanced GT Modification (AMGTT) or AMGTT CgPA Upgrade Enabled	CGGTMOD
ANSI/ITU SCCP Conversion Enabled	The domain (ANSI or ITU) of the point code and the GTT set that will be assigned to the GTA entry will be different.
Hex Digit Support for GTT Enabled	Hexadecimal digits will be specified for the <code>gta</code> or <code>egta</code> parameter values.
GTT Action - DISCARD, GTT Action - DUPLICATE, GTT Action - FORWARD Enabled	ACTSN
To enable, and turn on if necessary, any of these features, perform these procedures.	
<ul style="list-style-type: none"> • Origin-Based SCCP Routing - Activating the Origin-Based SCCP Routing Feature • Flexible GTT Load Sharing - Activating the Flexible GTT Load Sharing Feature. After the Flexible GTT Load Sharing feature has been enabled, perform one of these procedures. <ul style="list-style-type: none"> – If the <code>mrnset</code> and <code>ri=gt</code> parameters will be specified for the GTA entry, perform Provisioning MRN Entries to add the required MRNSET. – If the <code>mapset</code> and <code>ri=ssn</code> parameters will be specified for the GTA entry, perform one of these procedures to add the required MAPSET. <ul style="list-style-type: none"> * Provisioning a Solitary Mated Application * Provisioning a Dominant Mated Application * Provisioning a Load Shared Mated Application * Provisioning a Combined Dominant/Load Shared Mated Application • Flexible Linkset Optional Based Routing - Activating the Flexible Linkset Optional Based Routing Feature • TCAP Opcode Based Routing - Activating the TCAP Opcode Based Routing Feature • TOBR Opcode Quantity - Enabling a TOBR Opcode Quantity • SCCP Loop Detection - Activating the SCCP Loop Detection Feature. After the SCCP Loop Detection feature is enabled, perform the Adding a Loopset procedure to add the required loopset. • Advanced GT Modification or AMGTT CgPA Upgrade - Activating the Advanced GT Modification Feature. • ANSI/ITU SCCP Conversion - Activating the ANSI/ITU SCCP Conversion Feature • Hex Digit Support for GTT Enabled - Activating the Hex Digit Support for GTT Feature • GTT Action - DISCARD, GTT Action - DUPLICATE, GTT Action - FORWARD - Activating the GTT Actions Features. After the required GTT Actions feature is enabled, perform the Adding a GTT Action Set procedure to add the required GTT action set. 	
If the required feature is enabled, and turned on if required, shown in the <code>rtrv-ctrl-feat</code> output in 3 , the procedure for that feature does not need to be performed.	

5. To use either the `mrnset` parameter (if the routing indicator value for the global title translation is GT) or `mapset` parameter (if the routing indicator value for the global title translation is SSN), the Flexible GTT Load Sharing feature must be enabled. See [4](#). The `mrnset` and `mapset` parameters can be specified if the `xlat=none` parameter is specified for the GTA entry.

If the Flexible GTT Load Sharing feature is enabled, either the `mrnset` or `mapset` parameters, depending on the routing indicator value for the global title translation being added in this procedure, must be specified with the `ent-gta` command.

If the routing indicator for the global title translation being added is GT, there are two actions that can be taken:

- If the Flexible GTT Load Sharing feature is not enabled, continue the procedure with 7.
- If the Flexible GTT Load Sharing feature is enabled, continue the procedure with 6.

If the routing indicator for the global title translation being added is SSN, there are two actions that can be taken:

- If the Flexible GTT Load Sharing feature is not enabled, continue the procedure with one of these steps.
 - If the point code value is the EAGLE's point code, continue the procedure with 10.
 - If the point code value is a value other than the EAGLE's point code, the `ri` parameter value will be `ssn`, and the `xlat` parameter value will be `dpc`, continue the procedure with 11.
 - If the point code value is a value other than the EAGLE's point code, the `ri` parameter value will be `ssn`, and the `xlat` parameter value will be `dpcssn` when this procedure is completed, continue the procedure with 12.
- If the Flexible GTT Load Sharing feature is enabled, perform one of these steps.
 - If the point code value is the EAGLE's point code continue the procedure with 10.
 - If the point code value is a value other than the EAGLE's point code, or the `xlat` parameter value will be `dpc`, continue the procedure with 11.

If the `xlat=none` parameter will be specified and the Flexible GTT Load Sharing feature is not enabled, continue the procedure with 16.

If the `xlat=none` parameter will be specified and the Flexible GTT Load Sharing feature is enabled, continue the procedure by performing one of these steps. Both the `mrnset` and `mapset` parameters can be specified for the GTA entry.

- If the `mrnset` parameter will be specified, continue the procedure with 6.
 - If the `mapset` parameter will be specified, continue the procedure with 11.
6. The point code and MRN set ID specified for the global title translation must be shown in the `rtrv-mrn` command output. The point code must be assigned to the MRN set that will be specified with the `ent-gta` command.

Enter the `rtrv-mrn` command to verify that the required MRN set is configured in the database, and that the required point code is assigned to the MRN set. The following is an example of the possible output.

```
rlghncxa03w 09-05-28 21:15:37 GMT EAGLE5 41.0.0
```

```
MRNSET  PC          RC
DFLT    001-001-001     10
         001-001-002     20
         001-001-003     30
         001-254-255     40
```

```
MRNSET  PC          RC
110     001-001-001     10
```

```

001-001-005    20
001-001-006    30
001-001-003    40
001-001-008    50

MRNSET  PC          RC
111     001-001-001  30
        001-001-005  30
        001-001-006  30
        001-001-003  30
        001-001-008  30

MRNSET  PC          RC
112     001-003-001  10
        001-003-002  10
        001-003-003  30
        001-003-004  30
        001-003-006  60
        001-003-007  60
        001-003-008  80
        001-003-009  80

MRNSET  PCN          RC
113     s-1-1-1-0123-aa  1
        s-1-1-1-0235-aa  2
        s-1-1-1-0235-aa  3

```

 **Note:**

If the Weighted GTT Load Sharing feature is enabled, the `WT`, `%WT`, and `THR` columns are shown in the `rtrv-mrn` output

If the required MRN set is not shown in the `rtrv-mrn` output, provision the required MRN set by performing the [Provisioning MRN Entries](#) procedure.

If the required MRN set is shown in the `rtrv-mrn` output, or the [Provisioning MRN Entries](#) procedure has been performed, continue the procedure by performing one of these steps.

- If the `ri=gt` parameter will be specified, continue the procedure with [16](#).
 - If the `xlat=none` parameter will be specified, continue the procedure by performing one of these steps.
 - If the `mapset` parameter will be specified, continue the procedure with [11](#).
 - If the `mapset` parameter will not be specified, continue the procedure with [16](#).
7. Display the destination point codes in the database by entering the `rtrv-dstn` command. This is an example of the possible output.

```

rlghncxa03w 10-12-10 11:43:04 GMT EAGLE5 43.0.0
Extended Processing Time may be Required

```

DPCA	CLLI	BEI	ELEI	ALIASI	ALIASN
DMN					
001-207-000	-----	no	---	-----	-----
SS7					
001-001-001	-----	no	---	-----	-----
SS7					
001-001-002	-----	no	---	-----	-----
SS7					
001-005-000	-----	no	---	-----	-----
SS7					
001-007-000	-----	no	---	-----	-----
SS7					
008-012-003	-----	no	---	-----	-----
SS7					
003-002-004	-----	no	---	-----	-----
SS7					
009-002-003	-----	no	---	-----	-----
SS7					
010-020-005	-----	no	---	-----	-----
SS7					

DPCI	CLLI	BEI	ELEI	ALIASI	ALIASN
DMN					
1-207-0	-----	no	---	-----	-----
SS7					
0-015-0	-----	no	---	-----	-----
SS7					
0-017-0	-----	no	---	-----	-----
SS7					
1-011-1	-----	no	---	-----	-----
SS7					
1-011-2	-----	no	---	-----	-----
SS7					

DPCN	CLLI	BEI	ELEI	ALIASA
ALIASI	DMN			

DPCN24	CLLI	BEI	ELEI	ALIASA
ALIASI	DMN			

Destination table is (14 of 2000) 1% full

Alias table is (0 of 12000) 0% full

PPC table is (1 of 20) 5% full

If the required point code is not shown in the `rtrv-dstn` output, perform the "Adding a Destination Point Code" procedure in *Database Administration - SS7 User's Guide* to add the required point code. A proxy point code cannot be assigned to the point code. After the new point code has been added, perform one of the Adding a Route procedures in *Database Administration - SS7 User's Guide* and add the required route to the database. After the route has been added, continue the procedure with 5.

If the required point code is shown in the `rtrv-dstn` output, continue the procedure with 8.

- Display the point code that will be assigned to the GTA entry by using the `rtrv-dstn` command and specifying the point code. For this example, enter this command.

```
rtrv-dstn:dpca=010-020-005
```

This is an example of the possible output.

```
rlghncxa03w 10-12-10 11:43:04 GMT EAGLE5 43.0.0
```

DPCA	CLLI	BEI	ELEI	ALIASI
ALIASN/N24	DMN			
010-020-005	-----	no	---	-----
-----	SS7			

PPCA	NCAI	PRX	RCAUSE	NPRST	SPLITIAM	HMSMSC	HMSCP
SCCPMSGCNV							
009-002-003	----	no	none	off	none	no	no none

```
Destination table is (14 of 2000) 1% full
Alias table is (0 of 12000) 0% full
PPC table is (1 of 20) 5% full
```

A proxy point code (a point code value is shown in the `PPC` column) cannot be assigned to the point code. If a proxy point code is shown in this step, choose another point code from the `rtrv-dstn` output in the previous step and repeat this step.

If a proxy point code is not assigned to the point code, continue the procedure with [9](#).

- The point code specified with the `ent-gta` command must be the DPC of a route, unless the point code is the EAGLE's point code. Enter the `rtrv-rte` command with the `dpc` parameter specifying the point code to be used with the `ent-gta` command to verify whether or not the point code is the DPC of a route. For this example, enter these commands.

```
rtrv-rte:dpca=001-255-100
```

This is an example of the possible output.

```
rlghncxa03w 09-05-07 11:43:04 GMT EAGLE5 41.0.0
```

DPCA	ALIASI	ALIASN/N24	LSN	RC	APCA
001-255-100	-----	-----	ls03	10	
001-255-100			ls02	30	
150-150-150			lsa2	50	
200-200-200					

```
RTX:No CLLI=ls03clli
```

```
rtrv-rte:dpca=001-255-252
```

This is an example of the possible output.

```
rlghncxa03w 09-05-07 11:43:04 GMT EAGLE5 41.0.0
```

DPCA	ALIASI	ALIASN/N24	LSN	RC	APCA
------	--------	------------	-----	----	------

```

001-255-252 -----
001-255-252                                ls07      10
                                           ls08      30
025-025-150                                lsa5      50
066-030-100
                                           RTX:No  CLLI=ls07clli

```

rtrv-rte:dPCA=001-255-001

This is an example of the possible output.

```

rlghncxa03w 06-10-07 11:43:04 GMT  EAGLE5 36.0.0
  DPCA          ALIASI          ALIASN/N24  LSN      RC      APCA
  001-255-001 -----
001-255-001                                ls05      10
                                           ls15      30
089-047-123                                lsa8      50
077-056-000
                                           RTX:No  CLLI=ls05clli

```

If the point code is not shown in the `rtrv-rte` output, the point code is not the DPC of a route. Perform one of the Adding a Route procedures in *Database Administration - SS7 User's Guide* to add the required route to the database.

If the point code is shown in the `rtrv-rte` output, or if a new route was added, continue the procedure with [16](#).

10. If the `ri=ssn` and `xlat=dpcssn` parameters are specified with the `ent-gta` command, and you wish to use the EAGLE's point code for the value of the `pc` parameter of the `ent-gta` command, the point code value must be in the EAGLE's self ID table. Display the EAGLE self-identification, using the `rtrv-sid` command.

This is an example of the possible output.

```

rlghncxa03w 09-05-10 11:43:04 GMT  EAGLE5 41.0.0
  PCA          PCI          PCN
  CLLI          PCTYPE
  010-020-030   1-023-1      12-0-14-1
rlghncxa03w    OTHER
               s-1-023-1   s-12-0-14-1

  CPCA
  002-002-002   002-002-003   002-002-004   002-002-005
  002-002-006   002-002-007   002-002-008   002-002-009
  004-002-001   004-003-003   050-060-070

  CPCI
  1-001-1       1-001-2       1-001-3       1-001-4
  1-002-1       1-002-2       1-002-3       1-002-4
  2-001-1       7-222-7

  CPCN

```

```
2-0-10-3          2-0-11-0          2-0-11-2          2-0-12-1
2-2-3-3          2-2-4-0          10-14-10-1
```

11. Enter the `rtrv-map` command with the `pc` parameter specifying the required point code to verify that the required data is in the mated application table.

For this example enter this command.

```
rtrv-map:pca=001-255-001
```

```
rlghncxa03w 09-07-25 09:42:31 GMT EAGLE5 41.1.0
```

```
PCA          Mate PCA          SSN RC MULT SRM MRC GRP NAME SSO
MAPSET ID=DFLT
001-255-001          55  5  DOM YES YES ----- OFF
                   001-001-002  15 15  DOM YES YES ----- ON
                   001-001-003  25 20  DOM YES YES ----- ON
                   001-001-002  40 35  DOM YES YES ----- OFF
MAPSET ID=1
001-255-001          50  5  DOM YES YES ----- OFF
                   001-001-002  10 15  DOM YES YES ----- ON
                   001-001-003  20 20  DOM YES YES ----- ON
                   001-001-002  40 35  DOM YES YES ----- OFF
MAPSET ID=2
001-255-001          5  10 SOL *Y *Y ----- OFF

MAP TABLE IS (12 of 36000) 1 % FULL
```

 **Note:**

If the Weighted GTT Load Sharing feature is enabled, the `WT,%WT,` and `THR` columns are shown in the `rtrv-map` output

If the `ri=ssn` and `xlat=dpc` parameters are being specified with the `ent-gta` command, the point code must be in the mated application table. If the point code is not in the mated application table when the `ent-gta` command is executed, the `force=yes` parameter must be specified with the `ent-gta` command. If the `force=yes` parameters will be specified with the `ent-gta` command, continue the procedure with [12](#).

If the EAGLE's true point code and the EAGLE's subsystem number, along with the `ri=ssn` and `xlat=dpcssn` parameters are being specified with the `ent-gta` command, the EAGLE's true point code and the EAGLE's subsystem number must be in the mated application table.

If the required point code, subsystem number, or MAP set ID is not shown in the `rtrv-map` output, perform one of these procedures to add the required information to the mated application table.

- [Provisioning a Solitary Mated Application](#)
- [Provisioning a Dominant Mated Application](#)
- [Provisioning a Load Shared Mated Application](#)
- [Provisioning a Combined Dominant/Load Shared Mated Application](#)

Continue the procedure by performing one of these steps.

- If the `ri=ssn` parameter will be specified, continue the procedure by performing one of these steps.
 - if the EAGLE's point code and subsystem number will be specified with the `ent-gta` command, continue the procedure with 15.
 - if the EAGLE's point code and subsystem number will not be specified with the `ent-gta` command, and the `xlat=dpcssn` and `ri=ssn` parameters will be specified with the `ent-gta` command, continue the procedure with 16.
 - if the `xlat=dpc` and `ri=ssn` parameters will be specified with the `ent-gta` command, without the `force=yes` parameter, continue the procedure with 16.
- If the `xlat=none` parameter will be specified, continue the procedure with 16.

12. Display the destination point codes in the database by entering the `rtrv-dstn` command. This is an example of the possible output.

```
rlghncxa03w 10-12-10 11:43:04 GMT EAGLE5 43.0.0
Extended Processing Time may be Required
```

DPCA	CLLI	BEI	ELEI	ALIASI	ALIASN
DMN					
001-207-000	-----	no	---	-----	-----
SS7					
001-001-001	-----	no	---	-----	-----
SS7					
001-001-002	-----	no	---	-----	-----
SS7					
001-005-000	-----	no	---	-----	-----
SS7					
001-007-000	-----	no	---	-----	-----
SS7					
008-012-003	-----	no	---	-----	-----
SS7					
003-002-004	-----	no	---	-----	-----
SS7					
009-002-003	-----	no	---	-----	-----
SS7					
010-020-005	-----	no	---	-----	-----
SS7					
DPCI					
CLLI					
DMN					
1-207-0	-----	no	---	-----	-----
SS7					
0-015-0	-----	no	---	-----	-----
SS7					
0-017-0	-----	no	---	-----	-----
SS7					
1-011-1	-----	no	---	-----	-----
SS7					
1-011-2	-----	no	---	-----	-----
SS7					

```

      DPCN          CLLI          BEI ELEI  ALIASA
ALIASI          DMN

```

```

      DPCN24        CLLI          BEI ELEI  ALIASA
ALIASI          DMN

```

```

Destination table is (14 of 2000) 1% full
Alias table is (0 of 12000) 0% full
PPC table is (1 of 20) 5% full

```

If the required point code is not shown in the `rtrv-dstn` output, perform the "Adding a Destination Point Code" procedure in *Database Administration - SS7 User's Guide* to add the required point code. A proxy point code cannot be assigned to the point code. After the new point code has been added, perform one of the Adding a Route procedures in *Database Administration - SS7 User's Guide* and add the required route to the database. After the route has been added, continue the procedure with 16.

If the required point code is shown in the `rtrv-dstn` output, continue the procedure with 13.

13. Display the point code that will be assigned to the mated application by using the `rtrv-dstn` command and specifying the point code. For this example, enter this command.

```
rtrv-dstn:dpc=010-020-005
```

This is an example of the possible output.

```
rlghncxa03w 10-12-10 11:43:04 GMT EAGLE5 43.0.0
```

```

      DPCA          CLLI          BEI ELEI  ALIASI
ALIASN/N24      DMN
      010-020-005  ----- no  --- -----
-----
                SS7

```

```

      PPCA          NCAI PRX      RCAUSE NPRST SPLITIAM HMSMSC HMSCP
SCCPMSGCNV
      009-002-003  ---- no      none   off   none   no    no    none

```

```

Destination table is (14 of 2000) 1% full
Alias table is (0 of 12000) 0% full
PPC table is (1 of 20) 5% full

```

A proxy point code (a point code value is shown in the `PPC` column) cannot be assigned to the point code. If a proxy point code is shown in this step, choose another point code from the `rtrv-dstn` output in the previous step and repeat this step.

If a proxy point code is not assigned to the point code, continue the procedure with 14.

14. The point code specified with the `ent-gta` command must be the DPC of a route, unless the point code is the EAGLE's point code. Enter the `rtrv-rte` command with the `dpc` parameter specifying the point code to be used with the `ent-gta`

command to verify whether or not the point code is the DPC of a route. For this example, enter these commands.

```
rtrv-rte:dpca=001-255-100
```

This is an example of the possible output.

```
rlghncxa03w 09-05-07 11:43:04 GMT EAGLE5 41.0.0
  DPCA          ALIASI          ALIASN/N24    LSN          RC          APCA
  001-255-100  -----
001-255-100                                     ls03         10
                                     ls02         30
150-150-150                                     lsa2         50
200-200-200
                                           RTX:No  CLLI=ls03clli
```

```
rtrv-rte:dpca=001-255-252
```

This is an example of the possible output.

```
rlghncxa03w 09-05-07 11:43:04 GMT EAGLE5 41.0.0
  DPCA          ALIASI          ALIASN/N24    LSN          RC          APCA
  001-255-252  -----
001-255-252                                     ls07         10
                                     ls08         30
025-025-150                                     lsa5         50
066-030-100
                                           RTX:No  CLLI=ls07clli
```

```
rtrv-rte:dpca=001-255-001
```

This is an example of the possible output.

```
rlghncxa03w 09-05-07 11:43:04 GMT EAGLE5 41.0.0
  DPCA          ALIASI          ALIASN/N24    LSN          RC          APCA
  001-255-001  -----
001-255-001                                     ls05         10
                                     ls15         30
089-047-123                                     lsa8         50
077-056-000
                                           RTX:No  CLLI=ls05clli
```

If the point code is not shown in the `rtrv-rte` output, the point code is not the DPC of a route. Perform one of the Adding a Route procedures in *Database Administration - SS7 User's Guide* to add the required route to the database.

If the point code is shown in the `rtrv-rte` output, or if a new route was added, continue the procedure with 16.

15. Enter the `rtrv-ss-appl` command to verify that either the LNP, EIR, V-Flex, ATINPQ, AIQ, or INP subsystem number (depending on which feature is on) is in the subsystem application table.

This is an example of the possible output.

```
rlghncxa03w 09-05-28 14:42:38 GMT EAGLE5 41.0.0
APPL      SSN      STAT
LNP      254      ONLINE
```

```
SS-APPL table is 20% FULL (1 of 5)
```

If the subsystem number is shown in the `rtrv-ss-appl` output, continue the procedure with [11](#). If no subsystem number is shown in the `rtrv-ss-appl` output, or if the `rtrv-ss-appl` command is rejected, go to one of these user's guides, depending on the type of subsystem you wish to use, to enable and turn on the feature as necessary, and add the subsystem to the subsystem application table.

- EIR subsystem – go to *EIR User's Guide User's Guide*.
- INP subsystem – go to *INP/AINPQ User's Guide*.
- LNP subsystem – go to *ELAP Administration and LNP Feature Activation User's Guide*.
- V-Flex subsystem – go to *V-Flex User's Guide*.
- ATINPQ subsystem – go to *ATINP User's Guide*.
- AIQ subsystem – go to *Analyzed Information Features User's Guide*.

If the Flexible GTT Load Sharing feature is enabled, shown in [3](#), a MAP set ID must be specified for the final global title translation. The point code and SSN specified for the final global title translation being added in this procedure must be assigned to the MAP set ID that will be assigned to the final global title translation. Perform [11](#) to verify that the required MAP set is configured in the database.

If the Flexible GTT Load Sharing feature is not enabled, and the `ri=ssn` and `xlat=dpc` parameters are not being specified with the `ent-gta` command, or if the EAGLE's true point code and the EAGLE's subsystem number, along with the `ri=ssn` and `xlat=dpcssn` parameters, are not being specified with the `ent-gta` command, continue the procedure with [16](#).

16. Continue the procedure by performing one or more of these steps depending on the parameters that will be specified with the `ent-gta` command.

If the `loopset` parameter will be specified for the GTA entry, and the desired LOOPSET value is not shown in the `rtrv-gta` output, continue the procedure with [17](#).

If the `gtmodid` parameter will be specified for the GTA entry, and the desired GTMODID value is not shown in the `rtrv-gta` output, continue the procedure with [18](#).

If the `actsn` parameter will be specified for the GTA entry, and the desired ACTSN value is not shown in the `rtrv-gta` output, continue the procedure with [19](#).

If the `loopset`, `gtmodid`, and `actsn` parameters will not be specified for the GTA entry, continue the procedure with [20](#).

17. Display all the loopsets in the database by entering this command.

```
rtrv-loopset:num=1000:force=yes
```

This is an example of the possible output.

```

LoopSet      Mode      Point Codes
=====
=====
cary2        notify    005-015-005      007-007-007      (ANSI)
              033-004-003      033-007-003
              005-027-005      007-004-007

cary4        notify    005-012-005      007-026-007      (ANSI)
              003-049-003      033-002-003
              005-008-055      007-014-007

apex3        discard   005-017-008      007-017-009      (ANSI)
              033-005-043      005-014-005
              005-017-005      007-014-007
              033-002-043      005-038-005
              007-009-027      033-003-043
              005-012-005      007-002-027

apex4        discard   005-007-008      027-007-009      (ANSI)
              033-005-003      005-004-055
              027-001-007      033-008-003
              033-007-003      005-003-055
              027-008-007

ral5         notify    005-005-005      007-007-007      (ANSI)
              003-004-003      003-001-003
              005-007-005      007-004-007
              003-002-003      005-008-005
              007-009-007      003-003-003
              005-002-005      007-002-007

ral6         notify    005-007-008      007-007-009      (ANSI)
              003-005-003      003-007-003
              005-007-005

dunn1        discard   005-002-055      007-051-007      (ANSI)
              003-008-033

rtp9         discard   005-002-005      007-001-007      (ANSI)
              003-008-003      003-007-003
              005-003-005      007-008-007
              005-004-005

rtp5         discard   005-007-008      007-007-009      (ANSI)
              003-005-003

rtp1         discard   005-005-005      007-007-007      (ANSI)
              003-004-003      003-007-003
              005-007-005      007-004-007
              005-004-005

rtp2         notify    005-007-008      007-007-009      (ANSI)
              003-005-003

```

```
rlghncxa03w 09-05-28 21:15:37 GMT EAGLE5 41.0.0
LOOPSET table is (11 of 1000) 1% full
RTRV-LOOPSET: MASP A - COMPLTD
```

 **Note:**

If the `rtrv-loopset` command is entered with no other parameters specified, a maximum of 50 entries are displayed. To display more than 50 entries, the `force=yes` parameter must be specified with the `rtrv-loopset` command and the `num` parameter value must be greater than 50. Since there can be a maximum of 1000 loopsets in the database, to display all the loopsets in the database, the `force=yes` and `num=1000` parameters must be specified with the `rtrv-loopset` command.

If the required loopset is not shown in the `rtrv-loopset` output, perform [Adding a Loopset](#) to add the required loopset.

if the required loopset is shown in the `rtrv-loopset` output, or if a new loopset was added, continue the procedure by performing one of these steps.

- If the `gtmodid` parameter will be specified for the GTA entry, and the desired GTMODID value is not shown in the `rtrv-gta` output, continue the procedure with [18](#).
- If the `actsn` parameter will be specified for the GTA entry, and the desired ACTSN value is not shown in the `rtrv-gta` output, continue the procedure with [19](#).
- If the `gtmodid` and `actsn` parameters will not be specified for the GTA entry, continue the procedure with [20](#).

- 18.** Display the GT modification information in the database using the `rtrv-gtmod` command.

This is an example of the possible output.

```
rlghncxa03w 10-07-07 00:29:31 GMT EAGLE5 42.0.0
```

GTMODID	NTT	NGTI	GT0FILL	NNP	NNAI	NPDD	NSDD	PRECD	CGPASSN
modid2	--	2	ON	--	--	--	--	PFX	--
modid5	--	2	OFF	--	--	--	--	PFX	--
modid6	--	4	ON	4	5	3	3	SFX	--
modid10	--	--	OFF	5	5	--	--	PFX	--
modid11	--	--	OFF	5	5	--	--	PFX	--

```
GTMOD table is (5 of 100000) 1% full.
```

If the desired GT modification entry is not displayed, perform the [Adding Global Title Modification Information](#) procedure to add the desired GT modification entry to the database.

If the desired GT modification entry is displayed or the [Adding Global Title Modification Information](#) procedure was performed, continue the procedure by performing one of these steps.

- If the `actsn` parameter will be specified for the GTA entry, and the desired ACTSN value is not shown in the `rtrv-gta` output, continue the procedure with [19](#).
- If the `actsn` parameter will not be specified for the GTA entry, continue the procedure with [20](#).

19. Display the GTT action sets in the database using the `rtrv-gttaset` command.

This is an example of the possible output.

```
rlghncxa03w 10-07-07 00:29:31 GMT EAGLE5 42.0.0

ACTSN      TEST  ActIds
          MODE
-----
act1       off   action1 (DUP),action4 (DUP),action25 (FWD),
          -----,-----,-----
act10      on    action20 (DUP),action4 (DUP),action21 (DUP),
          action25 (FWD),-----,-----
act3       off   action2 (DISC),-----,-----,
          -----,-----,-----
act5       on    action1 (DUP),action3 (DUP),action4 (DUP),
          action20 (DUP),action21 (DUP),action17 (TCAPERR)
act11      off   action10 (UDTS),-----,-----,
          -----,-----,-----
```

GTT-ASET table is (5 of 20000) 1% full.

If the desired GTT action set is not displayed, perform the [Adding a GTT Action Set](#) procedure to add the desired GT modification entry to the database.

If the desired GT modification entry is displayed or the [Adding a GTT Action Set](#) procedure was performed, continue the procedure with [20](#).

20. Add the global title address to a GTT set using the `ent-gta` command. Use these tables as a guide for the parameters that can be used with the `ent-gta` command.

- [Table 4-24](#)
- [Table 4-25](#)
- [Table 4-26](#)
- [Table 4-27](#)
- [Table 4-28](#)
- [Table 4-29](#)
- [Table 4-30](#)

- [Table 4-31](#)
- [Table 4-32](#)

 **Note:**

The command line on the terminal can contain up to 150 characters. If the parameters and values specified with the `ent-gta` command are too long to fit on the `ent-gta` command line, perform [Changing Global Title Address Information](#) to complete adding the GTA entry.

For this example, enter these commands.

```
ent-
gta:gttsn=t800:gta=9194605555:xlat=dpcngt:ri=gt:pc=001-255-10
0:mrnset=114 :opcsn=gttset12:cggtmod=yes:gtmodid=modid2
```

```
ent-
gta:gttsn=t800:gta=9194610000:egta=9194689999:xlat=dpcssn:ri=
ssn :pc=001-255-252:ssn=254:mapset=3:opcsn=gttset12:selid=12:
actsn=act5
```

```
ent-
gta:gttsn=t800:gta=3365840000:egta=3365849999:xlat=dpc :ri=ss
n:pc=001-255-001:mapset=1:optsn=gttset3
```

When each of these commands has successfully completed, this message appears.

```
rlghncxa03w 09-05-07 11:43:04 GMT EAGLE5 41.0.0
ENT-GTA: MASP A - COMPLTD
```

21. Verify the changes to the GTT set using the `rtrv-gta` command with the `gttsn` parameter value specified in 20 and one of the following parameters and values specified in 20, depending on what type of GTT set was specified in 20.
 - The `gta` parameter and value – if the GTT set was a CDGTA or CGGTA GTT set, or if the GTT set had no `SETTYPE` value.
 - The `cgssn` parameter and value – if the GTT set was a CGSSN GTT set.
 - The `cgpc/cgpca/cgpci/cgpcn/cgpcn24` parameter and value – if the GTT set was a CGPC GTT set.
 - The `opc/opca/opci/opcn/opcn24` parameter and value – if the GTT set was an OPC GTT set.
 - The `cdssn` parameter and value – if the GTT set was a CDSSN GTT set.
 - The `opcode` parameter and value – if the GTT set was an OPCODE GTT set.
 - The `dpc/dpca/dpci/dpcn/dpcn24` parameter and value – if the GTT set was an DPC GTT set.

If the `num` parameter is specified with the `rtrv-gta` command, and the value of the `num` parameter is greater than 1000, the `force=yes` parameter must be specified with the `rtrv-gta` command. For this example, enter these commands.

```
rtrv-gta:gttsn=t800:gta=9194605555
```

This is an example of the possible output.

```
rlghncxa03w 10-07-07 00:27:31 GMT EAGLE5 42.0.0

GTTSN      NETDOM  SETTYPE  NDGT
t800      ansi    CDGTA    10
GTA TABLE IS  1 % FULL  (17 of 269999)

START GTA  END GTA   XLAT   RI    PC
9194605555 9194605555 dpcngt gt    001-255-100
MRNSET=114  SSN=---  CCGT=no CGGTMOD=YES
GTMODID=modid2  TESTMODE=off
OPTSN=----- CGSELID=----- OPCSN=gttset12
ACTSN=----- PPMEASREQD= NO
```

Command Retrieved 1 Entries

```
rtrv-gta:gttsn=t800:gta=9194610000
```

This is an example of the possible output.

```
rlghncxa03w 10-07-07 00:27:31 GMT EAGLE5 42.0.0

GTTSN      NETDOM  SETTYPE  NDGT
t800      ansi    CDGTA    10
GTA TABLE IS  1 % FULL  (17 of 269999)

START GTA  END GTA   XLAT   RI    PC
9194610000 9194689999 dpcssn ssn    001-255-252
MAPSET=3    SSN=254 CCGT=no CGGTMOD=NO
GTMODID=----- TESTMODE=off
OPTSN=----- CGSELID=----- OPCSN=gttset12
ACTSN=act5   PPMEASREQD= NO
```

Command Retrieved 1 Entries

```
rtrv-gta:gttsn=t800:gta=3365840000
```

This is an example of the possible output.

```
rlghncxa03w 10-07-07 00:27:31 GMT EAGLE5 42.0.0

GTTSN      NETDOM  SETTYPE  NDGT
t800      ansi    CDGTA    10
GTA TABLE IS  1 % FULL  (17 of 269999)

START GTA  END GTA   XLAT   RI    PC
3365840000 3365849999 dpc    ssn    001-255-001
MAPSET=1    SSN=---  CCGT=no CGGTMOD=NO
GTMODID=----- TESTMODE=off
OPTSN=gttset3  CGSELID=----- OPCSN=-----
ACTSN=----- PPMEASREQD= NO
```

Command Retrieved 1 Entries

22. Backup the new changes using the `chg-db:action=backup:dest=fixed` command. These messages should appear, the active Maintenance and Administration Subsystem Processor (MASP) appears first.

```

BACKUP (FIXED): MASP A - Backup starts on active MASP.
BACKUP (FIXED): MASP A - Backup on active MASP to fixed disk
complete.
BACKUP (FIXED): MASP A - Backup starts on standby MASP.
BACKUP (FIXED): MASP A - Backup on standby MASP to fixed disk
complete.
    
```

Figure 4-12 Add Global Title Address Information - Sheet 1 of 9

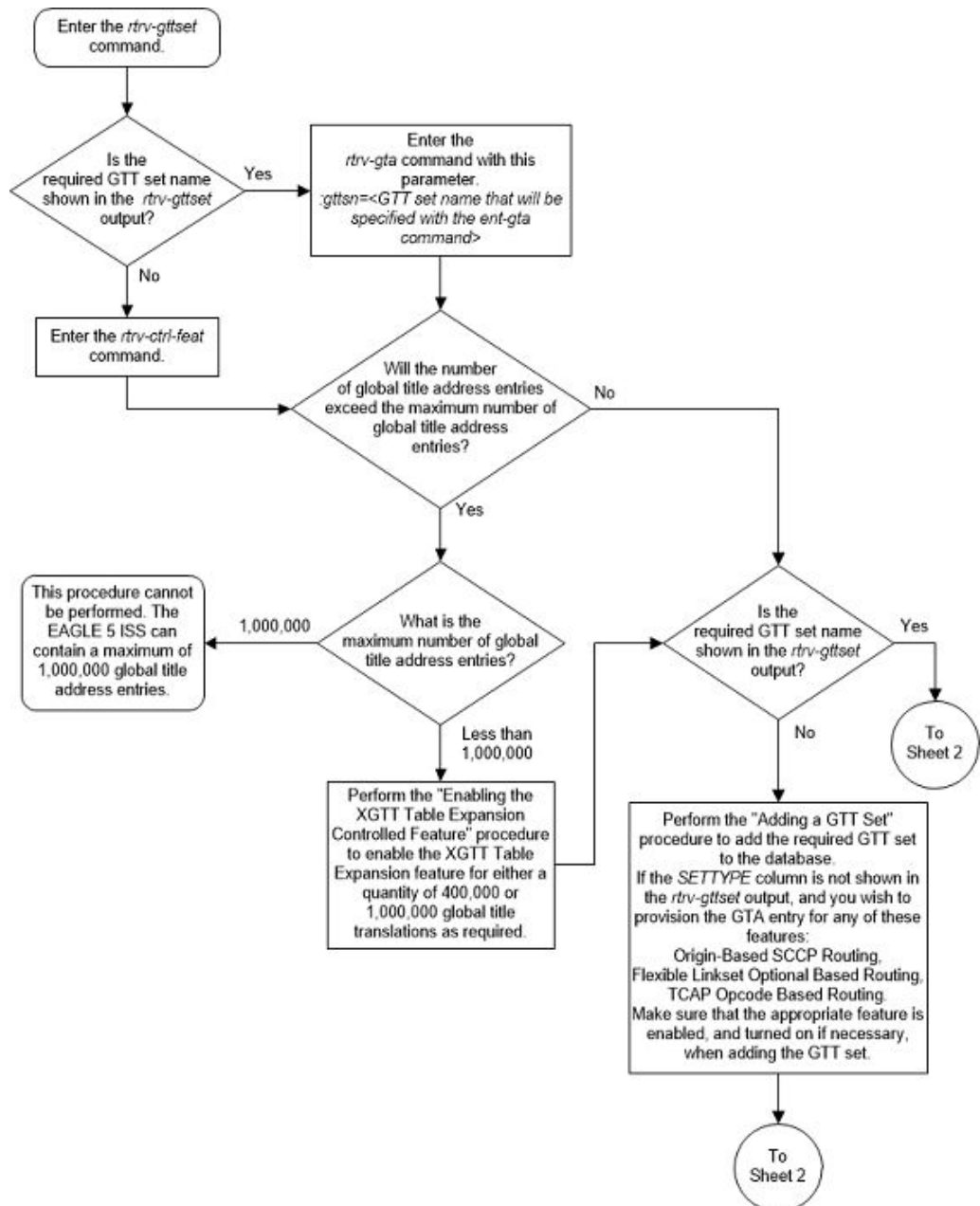

Figure 4-13 Add Global Title Address Information - Sheet 2 of 9

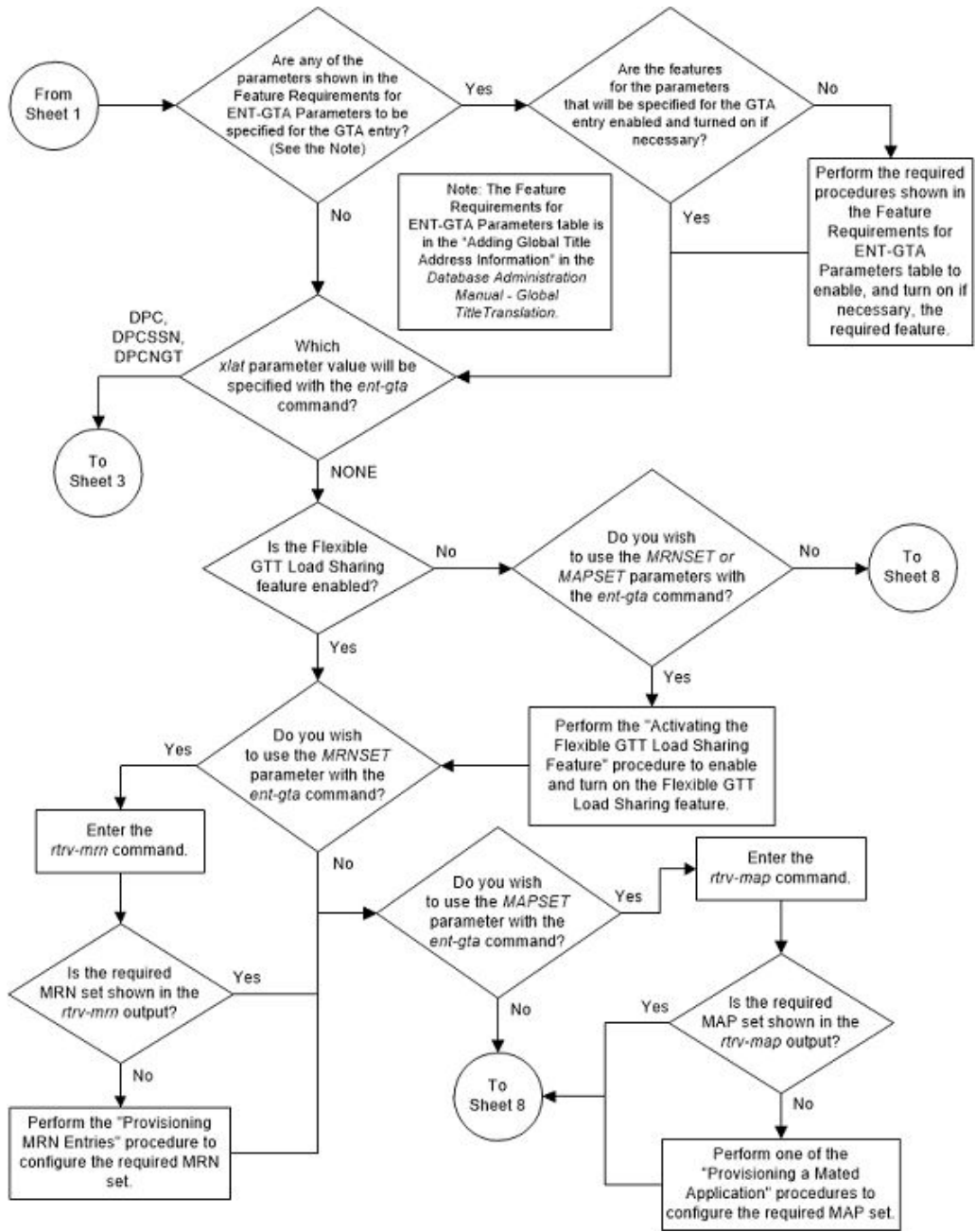

Figure 4-14 Add Global Title Address Information - Sheet 3 of 9

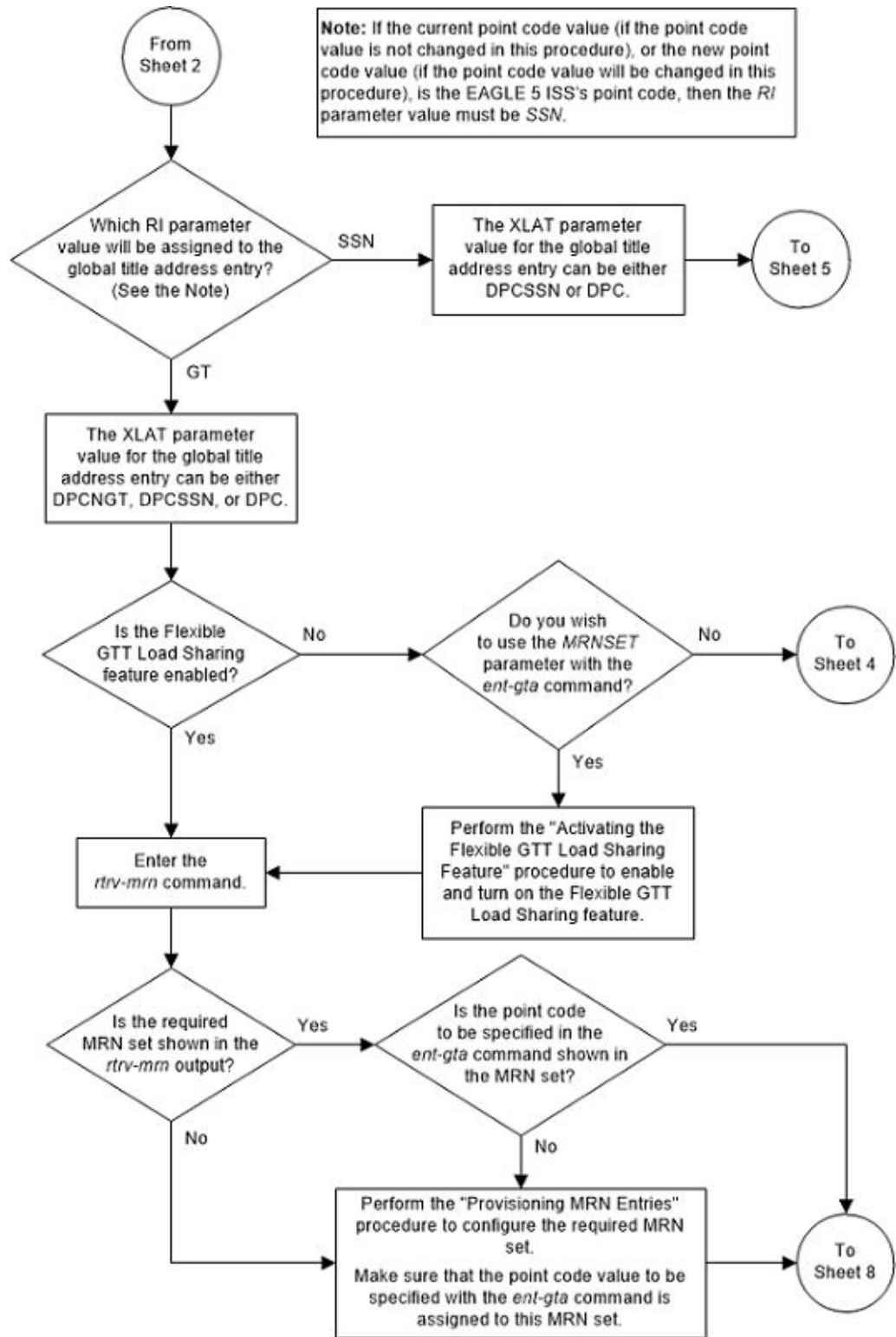

Figure 4-15 Add Global Title Address Information - Sheet 4 of 9

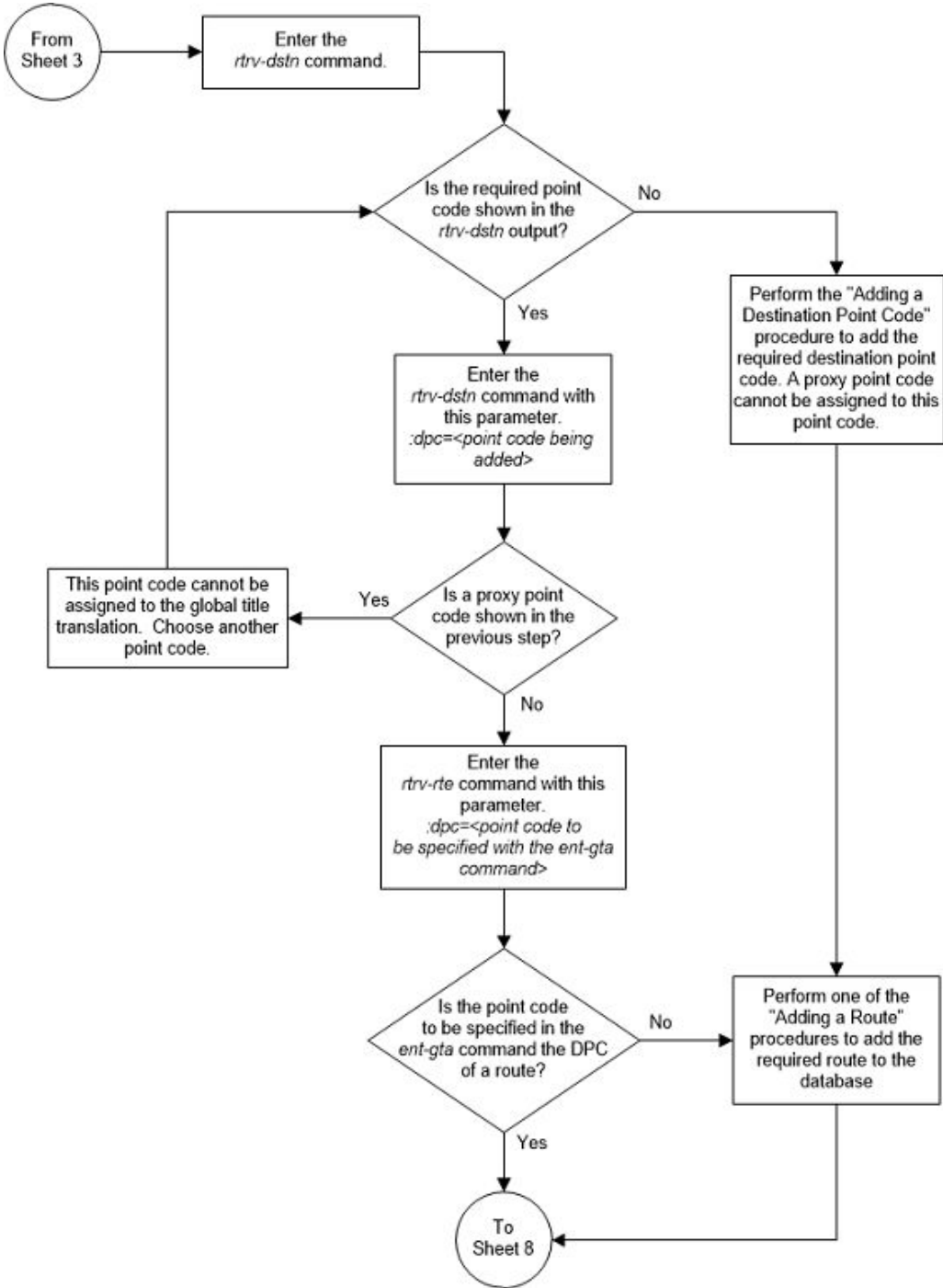

Figure 4-16 Add Global Title Address Information - Sheet 5 of 9

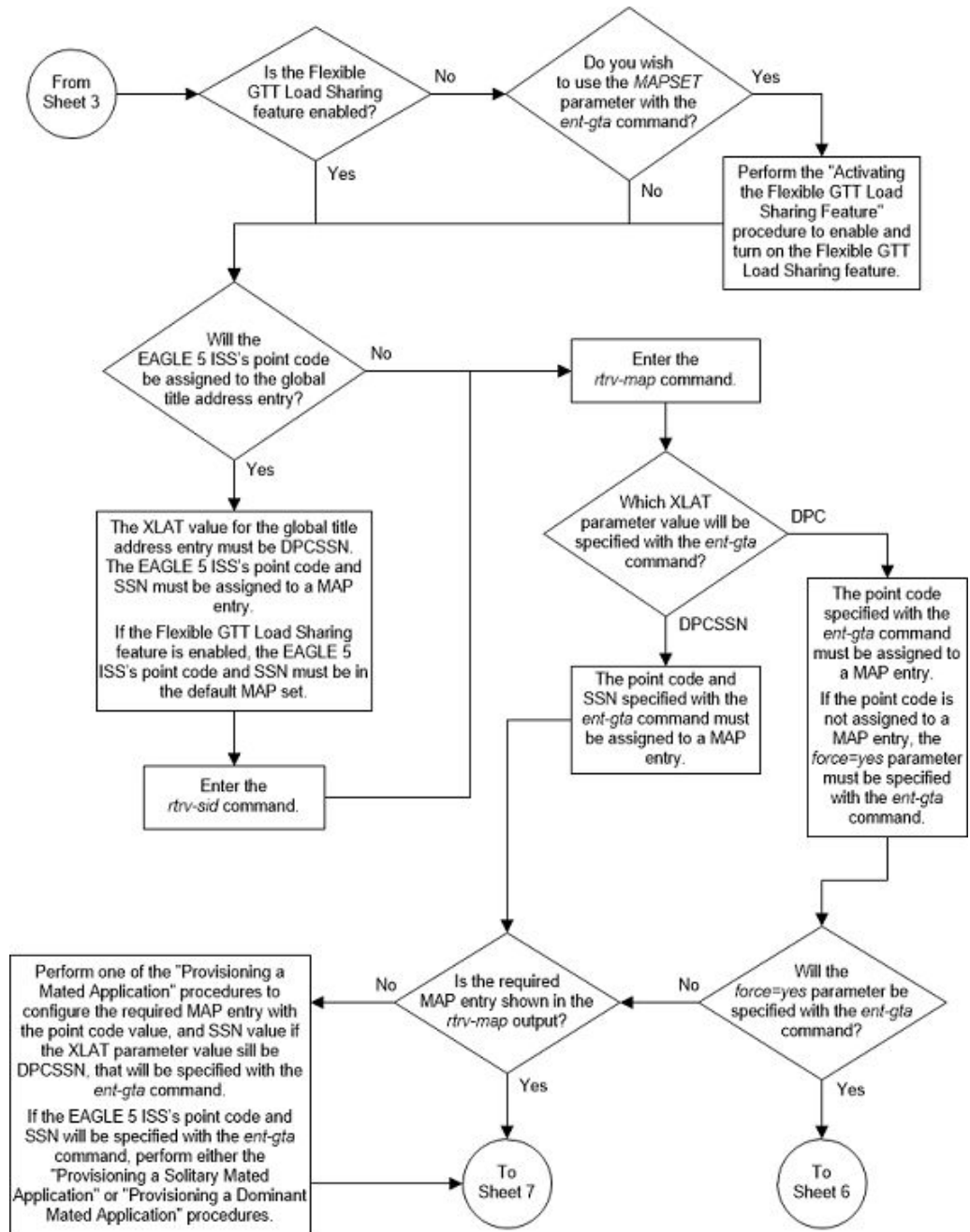

Figure 4-17 Add Global Title Address Information - Sheet 6 of 9

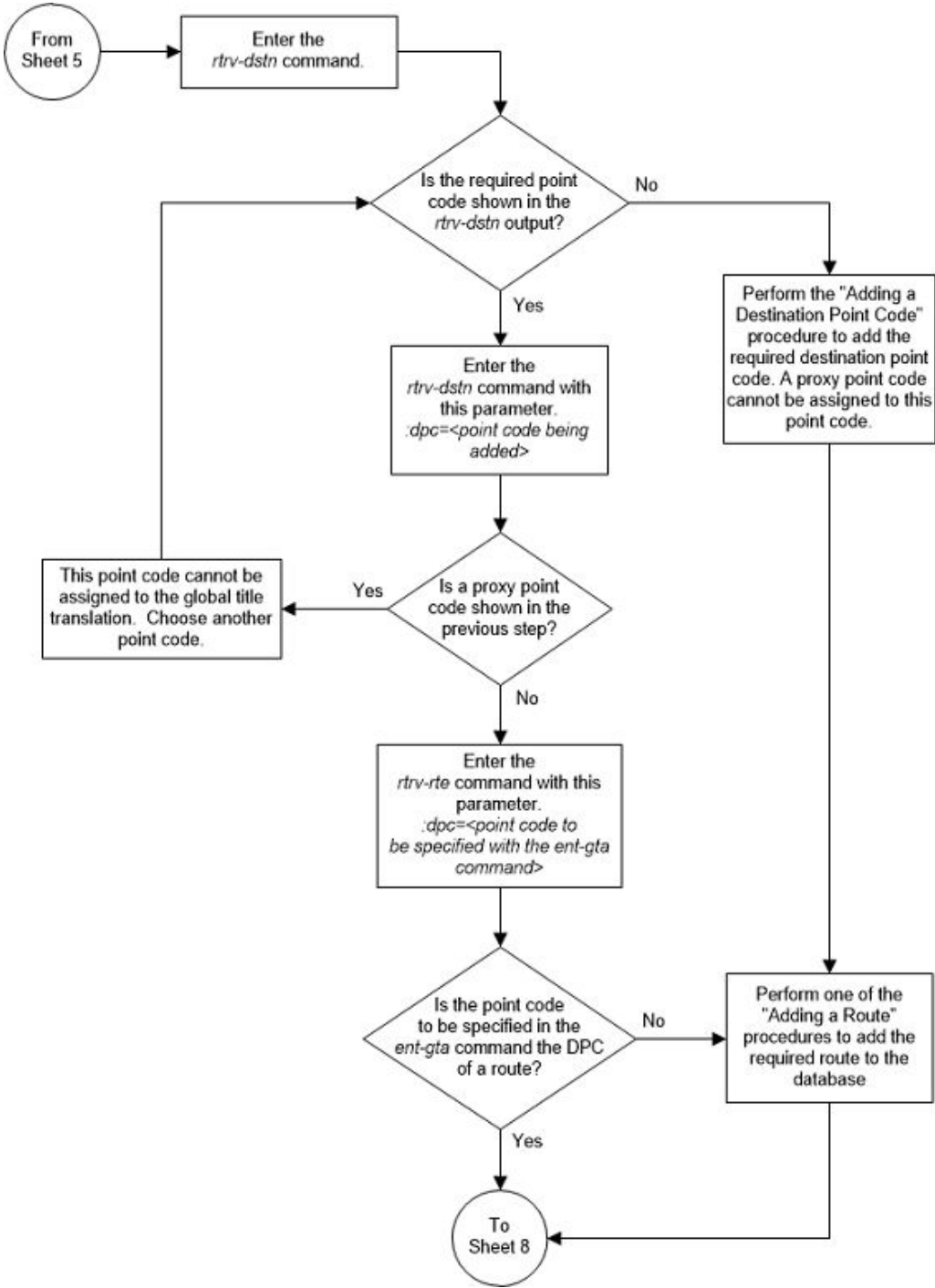

Figure 4-18 Add Global Title Address Information - Sheet 7 of 9

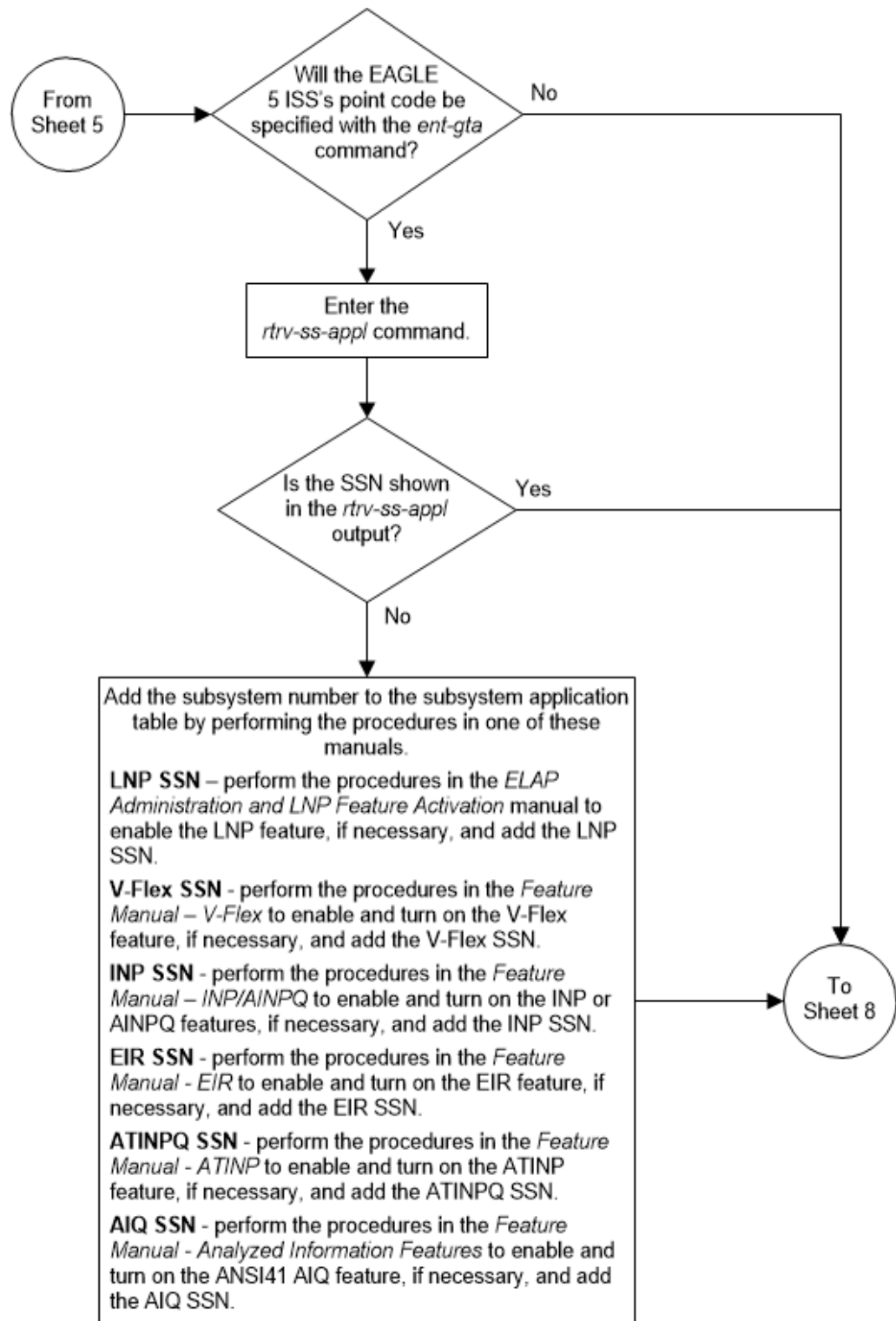

Figure 4-19 Add Global Title Address Information - Sheet 8 of 9

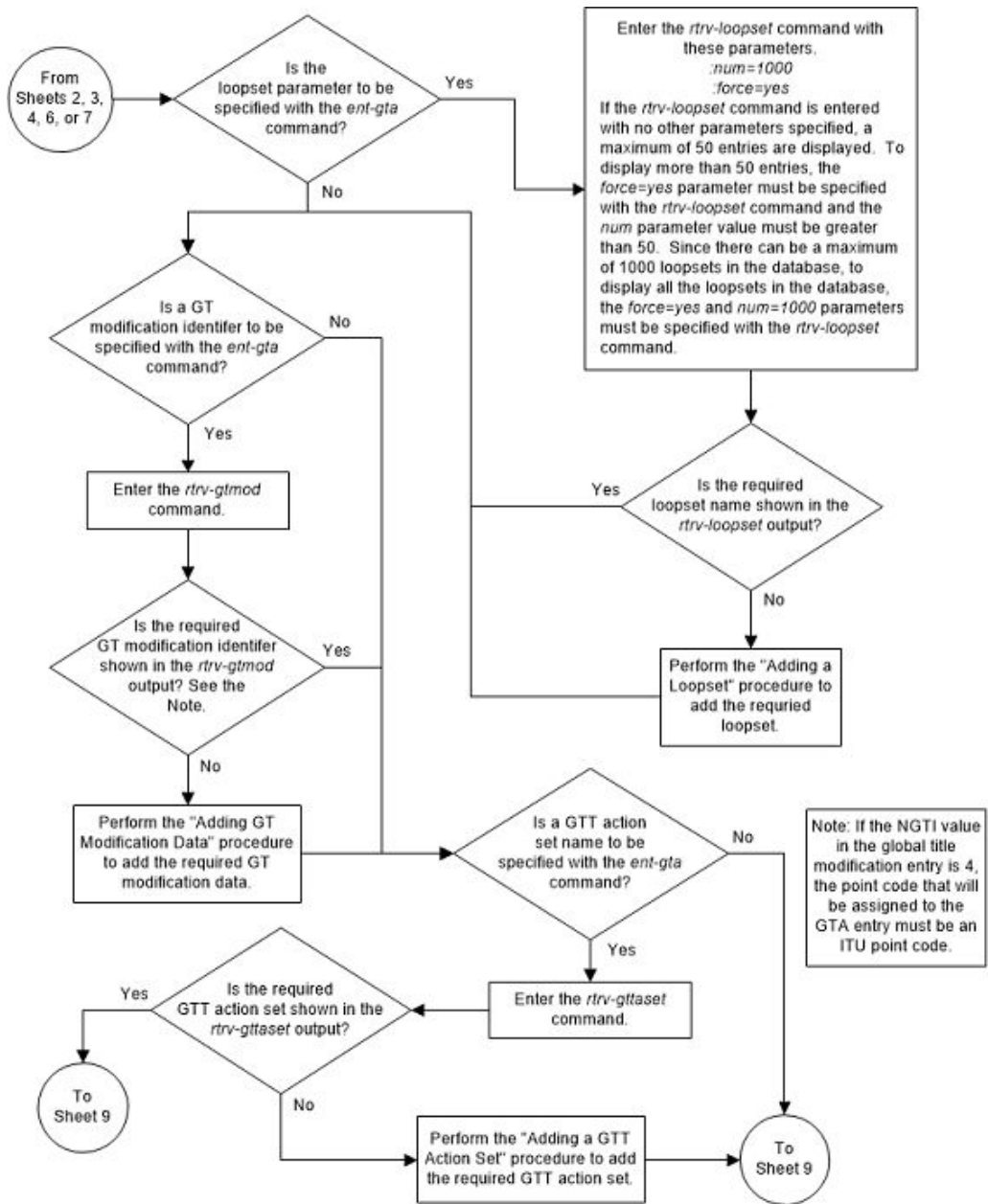
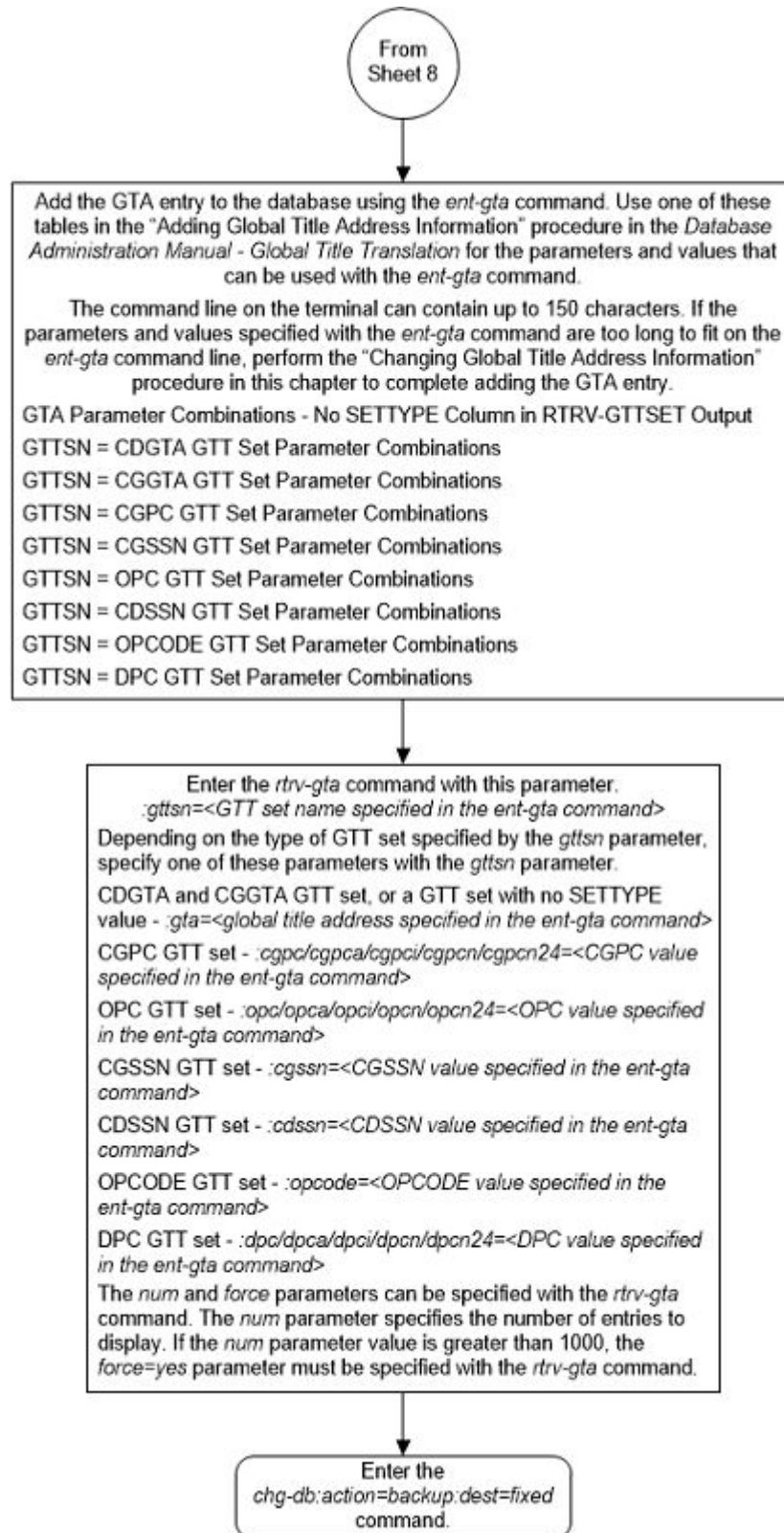

Figure 4-20 Add Global Title Address Information - Sheet 9 of 9



Removing Global Title Address Information

This procedure is used to remove an existing global title address information in the database using the `dlt-gta` command.

The `dlt-gta` command uses these parameters:

`:gttsn` – The GTT set name

`:gta` – The global title address or the beginning value of a range of global title addresses

`:egta` – The end value of a range of global title address.

`:cgssn` – The CGPA subsystem number or the beginning value of a range of CGPA subsystem numbers

`:ecgssn` – The end value of a range of CGPA subsystem numbers

`:cgpc/cgpcac/cgpci/cgpcn/cgpcn24` – The CGPA point code value

`:opcl/opcal/opcli/opcn/opcn24` – The originating point code value

`:dpc/dpca/dpci/dpcn/dpcn24` – The destination point code value

`:cdssn` – The CDPA subsystem number or the beginning value of a range of CDPA subsystem numbers

`:ecdssn` – The end value of a range of CDPA subsystem numbers

`:opcode` - The TCAP opcode field value in the incoming MSU.

`:acn` - The application context name value in the ITU TCAP ACN field in the incoming MSU.

`:family` - The ANSI TCAP family field value in the incoming MSU

`:pkgtype` - The ANSI TCAP and ITU TCAP package types.

The parameter combinations that can be used with the `dlt-gta` command are shown in these tables.

- [Table 4-35](#)
- [Table 4-36](#)
- [Table 4-37](#)

The GTT set name (`gttsn`) must be specified and match that of an existing GTT set name. Use the `rtrv-gttset` command to view the GTT set names. The destination point code (DPC) must be a full point code and cannot be out of range.

If the end of the global title address (`egta`) parameter is specified, the GTA and EGTA must have the same number of digits, but the EGTA must be larger than the GTA. The range, as specified by the start and end global title addresses, must be in the database for the specified translation type. Each range may be contained completely within a previously defined range, in which case splitting is performed. However, if the ranges overlap, splitting cannot occur, and the `dlt-gta` command is rejected with this message.

E2401 Cmd Rej:GTA range overlaps a current range

Along with error message 2401, a list of the overlapped global title addresses is displayed as shown in the following example.

```
rlghncxa03w 06-10-24 08:29:15 GMT EAGLE5 36.0.0
The following GTA ranges overlap the input GTA range
```

START GTA	END GTA
8005550000	8005551999
8005552000	8005553999
8005554000	8005555999

DLT-GTA: MASP A - Command Aborted

For a range of global title addresses, CGPA SSNs, or CDPA SSNs to be split, the new entry created by the split cannot increase the number of entries in the GTT table beyond the quantity shown in the `rtrv-gta` output.

When the VGTT feature is on, and the last global title address of a particular length is deleted for the specified GTT set name, then that length is no longer supported. That length is not displayed in the NDGT field of the `rtrv-gttset` command output. For example, if the last 7-digit global title address is deleted from GTT set `l1db` (from the previous example), the NDGT field of the `rtrv-gttset` command shows only the numbers three and 10 in the NDGT field indicating that GTT set `l1db` contains only 3- and 10-digit global title addresses.

Canceling the RTRV-GTA Command

Because the `rtrv-gta` command used in this procedure can output information for a long period of time, the `rtrv-gta` command can be canceled and the output to the terminal stopped. There are three ways that the `rtrv-gta` command can be canceled.

- Press the F9 function key on the keyboard at the terminal where the `rtrv-gta` command was entered.
- Enter the `canc-cmd` without the `trm` parameter at the terminal where the `rtrv-gta` command was entered.
- Enter the `canc-cmd:trm=<xx>`, where `<xx>` is the terminal where the `rtrv-gta` command was entered, from another terminal other than the terminal where the `rtrv-gta` command was entered. To enter the `canc-cmd:trm=<xx>` command, the terminal must allow Security Administration commands to be entered from it and the user must be allowed to enter Security Administration commands. The terminal's permissions can be verified with the `rtrv-secu-trm` command. The user's permissions can be verified with the `rtrv-user` or `rtrv-secu-user` commands.

For more information about the `canc-cmd` command, go to *Commands User's Guide*.

Table 4-35 DLT-GTA Parameter Combinations - EGTT Only

Mandatory Parameters
GTTSN – The GTT set name from the GTTSN column of the <code>rtrv-gta</code> output.

Table 4-35 (Cont.) DLT-GTA Parameter Combinations - EGTT Only

GTA – The GTA value from the `START` GTA column of the `rtrv-gta` output. (See Notes 1, 3, and 4)

Optional Parameters

EGTA – The EGTA value from the `END` GTA column of the `rtrv-gta` output. (See Notes 1 and 2)

Notes:

1. To remove an entry containing a range of GTAs, the `gta` and `egta` parameters must be specified with the values for each parameter that are shown in the `rtrv-gta` output.
2. The `egta` parameter does not need to be specified if the GTA entry contains an `egta` parameter value that is equal to the `gta` parameter value.
3. If a range of GTAs is assigned to the GTA entry, and only the `gta` parameter is specified, for example, 336337 - 3400000, and only the `gta=336337` parameter is specified, the entry is still in the database. The range of GTAs becomes 336338 - 3400000.
4. The range of GTAs can be split by specifying a `gta` parameter value in between the existing `gta` and `egta` parameter values. For example, the GTA range is 336337 - 3400000 and only the `gta=370000` parameter is specified. Two entries are created, one with the range of 336338 - 336999, and the other with the range of 337001 - 3400000.

Table 4-36 DLT-GTA Parameter Combinations - GTT Sets CDGTA, CGGTA, CGSSN, CGPC, OPC

GTT Set Type CDGTA	GTT Set Type CGGTA	GTT Set Type CGSSN	GTT Set Type CGPC	GTT Set Type OPC
Mandatory Parameters				
GTTSN – The GTT set name from the <code>GTTSN</code> column of the <code>rtrv-gttset</code> output containing the value <code>CDGTA</code> in the <code>SETTYPE</code> column.	GTTSN – The GTT set name from the <code>GTTSN</code> column of the <code>rtrv-gttset</code> output containing the value <code>CGGTA</code> in the <code>SETTYPE</code> column.	GTTSN – The GTT set name from the <code>GTTSN</code> column of the <code>rtrv-gttset</code> output containing the value <code>CGSSN</code> in the <code>SETTYPE</code> column.	GTTSN – The GTT set name from the <code>GTTSN</code> column of the <code>rtrv-gttset</code> output containing the value <code>CGPC</code> in the <code>SETTYPE</code> column.	GTTSN – The GTT set name from the <code>GTTSN</code> column of the <code>rtrv-gttset</code> output containing the value <code>OPC</code> in the <code>SETTYPE</code> column.
GTA – The GTA value from the <code>START</code> GTA column of the <code>rtrv-gta</code> output. (See Notes 1, 3, and 4)	GTA – The GTA value from the <code>START</code> GTA column of the <code>rtrv-gta</code> output. (See Notes 1, 3, and 4)	CGSSN – The CGSSN value from the <code>START</code> SSN column of the <code>rtrv-gta</code> output. (See Notes 5, 7, and 8)	CGPC/CGPCA/ CGPCI/CGPCN/ CGPCN24 – The CGPC value from the <code>CGPCA</code> or <code>CGPC (ITU)</code> column of the <code>rtrv-gta</code> output	OPC/OPCA/ OPCI/OPCN/ OPCN24 – The OPC value from the <code>OPCA</code> or <code>OPC (ITU)</code> column of the <code>rtrv-gta</code> output
Optional Parameters				

Table 4-36 (Cont.) DLT-GTA Parameter Combinations - GTT Sets CDGTA, CCGTA, CGSSN, CGPC, OPC

GTT Set Type CDGTA	GTT Set Type CCGTA	GTT Set Type CGSSN	GTT Set Type CGPC	GTT Set Type OPC
EGTA – The EGTA value from the END GTA column of the <code>rtrv-gta</code> output. output. (See Notes 1 and 2)	EGTA – The EGTA value from the END GTA column of the <code>rtrv-gta</code> output. (See Notes 1 and 2)	ECGSSN – The ECGSSN value from the END SSN column of the <code>rtrv-gta</code> output. (See Notes 5, 6, and 8)	No optional parameters.	No optional parameters.
Notes:				
1. To remove an entry containing a range of GTAs, the <code>gta</code> and <code>egta</code> parameters must be specified with the values for each parameter that are shown in the <code>rtrv-gta</code> output.				
2. The <code>egta</code> parameter does not need to be specified if the GTA entry contains an <code>egta</code> parameter value that is equal to the <code>gta</code> parameter value.				
3. If a range of GTAs is assigned to the GTA entry, and only the <code>gta</code> parameter is specified, for example, 336337 - 3400000, and only the <code>gta=336337</code> parameter is specified, the entry is still in the database. The range of GTAs becomes 336338 - 3400000.				
4. The range of GTAs can be split by specifying a <code>gta</code> parameter value in between the existing <code>gta</code> and <code>egta</code> parameter values. For example, the GTA range is 336337 - 3400000 and only the <code>gta=370000</code> parameter is specified. Two entries are created, one with the range of 336338 - 336999, and the other with the range of 337001 - 3400000.				
5. To remove an entry containing a range of CGSSNs, the <code>cgssn</code> and <code>ecgssn</code> parameters must be specified with the values for each parameter that are shown in the <code>rtrv-gta</code> output.				
6. The <code>ecgssn</code> parameter does not need to be specified if the GTA entry contains an <code>ecgssn</code> parameter value that is equal to the <code>cgssn</code> parameter value.				
7. If a range of CGSSNs is assigned to the GTA entry, and only the <code>cgssn</code> parameter is specified, for example, 25 - 75, and only the <code>cgssn=25</code> parameter is specified, the entry is still in the database. The range of CGSSNs becomes 26 - 75.				
8. The range of CGSSNs can be split by specifying a <code>cgssn</code> parameter value in between the existing <code>cgssn</code> and <code>ecgssn</code> parameter values. For example, the CGSSN range is 25 - 75 and only the <code>cgssn=50</code> parameter is specified. Two entries are created, one with the range of 25 - 49, and the other with the range of 51 - 75.				

Table 4-37 DLT-GTA Parameter Combinations - GTT Sets CDSSN, DPC, and OPCODE

GTT Set Type CDSSN	GTT Set Type DPC	GTT Set Type OPCODE	
Mandatory Parameters			
GTTSN – The GTT set name from the GTTSN column of the <code>rtrv-gttset</code> output containing the value CDSSN in the SETTYPE column.	GTTSN – The GTT set name from the GTTSN column of the <code>rtrv-gttset</code> output containing the value DPC in the SETTYPE column.	ANSI TCAP Translation	ITU TCAP Translation
		GTTSN – The GTT set name from the GTTSN column of the <code>rtrv-gttset</code> output containing the value OPCODE in the SETTYPE column.	GTTSN – The GTT set name from the GTTSN column of the <code>rtrv-gttset</code> output containing the value OPCODE in the SETTYPE column.

Table 4-37 (Cont.) DLT-GTA Parameter Combinations - GTT Sets CDSSN, DPC, and OPCODE

GTT Set Type CDSSN	GTT Set Type DPC	GTT Set Type OPCODE	
CDSSN – The CDSSN value from the START SSN column of the <i>rtrv-gta</i> output. (See Notes 1, 3, and 4)	DPC/DPCA/ DPCI/DPCN/ DPCN24 – The DPC value from the DPCA or DPC (ITU) column of the <i>rtrv-gta</i> output	FAMILY – The FAMILY value from the FAMILY column of the <i>rtrv-gta</i> output.	ACN – The ACN value from the ACN column of the <i>rtrv-gta</i> output.
		OPCODE - The OPCODE value from the OPCODE column of the <i>rtrv-gta</i> output.	OPCODE - The OPCODE value from the OPCODE column of the <i>rtrv-gta</i> output.
		PKGTYPE - The PKGTYPE value from the PKGTYPE column of the <i>rtrv-gta</i> output.	PKGTYPE - The PKGTYPE value from the PKGTYPE column of the <i>rtrv-gta</i> output.

Optional Parameters

ECDSSN – The ECDSSN value from the END SSN column of the <i>rtrv-gta</i> output. (See Notes 1 and 2)	No optional parameters.	No optional parameters.	No optional parameters.
--	-------------------------	-------------------------	-------------------------

Notes:

1. To remove an entry containing a range of CDSSNs, the *cdssn* and *ecdssn* parameters must be specified with the values for each parameter that are shown in the *rtrv-gta* output.
2. The *ecdssn* parameter does not need to be specified if the GTA entry contains an *ecdssn* parameter value that is equal to the *cdssn* parameter value.
3. If a range of CDSSNs is assigned to the GTA entry, and only the *cdssn* parameter is specified, for example, 100 - 200, and only the *cdssn=100* parameter is specified, the entry is still in the database. The range of CDSSNs becomes 101 - 200.
4. The range of CDSSNs can be split by specifying a *cdssn* parameter value in between the existing *cdssn* and *ecdssn* parameter values. For example, the CDSSN range is 100 - 200 and only the *cdssn=150* parameter is specified. Two entries are created, one with the range of 100 - 149, and the other with the range of 151 - 200.

1. Display the existing GTT sets in the database using the *rtrv-gttset* command.

This is an example of the possible output.

```
rlghncxa03w 10-07-07 00:27:31 GMT EAGLE5 42.0.0
```

```
GTTSN      NETDOM  SETTYPE  NDGT
abcd1234   itu     CDGTA    12
dpc1       ansi    DPC      6
gttset1    ansi    CDGTA    6
gttset2    ansi    CGGTA    10
gttset3    ansi    OPC      -
gttset4    ansi    CGPC     -
```

```

gttset5    itu    CGPC    -
imsi      itu    CDGTA   15
lidx      ansi   CDGTA   10
si000     itu    CDGTA   15
t800     ansi   CDGTA   10
gttset6   ansi   CDSSN   -
gttset7   itu    OPCODE  -
  
```

GTT-SET table is (13 of 2000) 1% full.

If the Origin-Based SCCP Routing feature is not enabled and the Flexible Linkset Optional Based Routing feature is not enabled and turned on, the SETTYPE column is not shown in the `rtrv-gttset` output.

If the Origin-Based SCCP Routing feature is not enabled, the values CGGTA, CGPC, CGSSN, and OPC are not shown in the `rtrv-gttset` output.

If the Flexible Linkset Optional Based Routing feature is not enabled and turned on, the values CDSSN, and DPC are not shown in the `rtrv-gttset` output.

If the TCAP Opcode Based Routing feature is not enabled, the value OPCODE is not shown in the `rtrv-gttset` output.

2. Display the global title address (GTA) information for the GTT set that contains the GTA information to be removed.

Use the `rtrv-gta` command with the `gttsn` parameter value shown in the output of 1. If the `num` parameter is specified with the `rtrv-gta` command, and the value of the `num` parameter is greater than 1000, the `force=yes` parameter must be specified with the `rtrv-gta` command. For this example, enter this command.

```
rtrv-gta:gttsn=t800
```

This is an example of the possible output.

```

rlghncxa03w 10-07-07 00:28:31 GMT EAGLE5 42.0.0
GTTSN      NETDOM  SETTYPE  NDGT
t800      ansi    CDGTA    10
  
```

GTA TABLE IS 1 % FULL (17 of 26999)

```

START GTA  END GTA    XLAT  RI    PC
3365840000 3365849999 DPC   SSN   001-255-001
          SSN=0   CCGT=no  CGGTMOD=NO
          GTMODID=----- TESTMODE=off
          OPTSN=----- CGSELID=----- OPCS=-----
          ACTSN=----- PPMEASREQD= NO
8005550000 8005551999 dpcssn ssn   001-254-255
          SSN=255 CCGT=no  CGGTMOD=NO
          GTMODID=----- TESTMODE=off
          OPTSN=----- CGSELID=----- OPCS=-----
          ACTSN=----- PPMEASREQD= NO
8005552000 8005553999 dpc   gt    001-254-255
          SSN=0   CCGT=no  CGGTMOD=NO
          GTMODID=----- TESTMODE=off
          OPTSN=----- CGSELID=----- OPCS=-----
  
```

```

    ACTSN=----- PPMEASREQD= NO
8005554000 8005555999 dpcngt gt      001-254-255
    SSN=--- CCGT=no CGGTMOD=NO
    GTMODID=----- TESTMODE=off
    OPTSN=----- CGSELID=----- OPCS=gttset3
    ACTSN=----- PPMEASREQD= NO
8005556000 8005557999 dpcssn ssn    001-254-255
    SSN=255 CCGT=no CGGTMOD=NO
    GTMODID=----- TESTMODE=off
    OPTSN=----- CGSELID=----- OPCS=-----
    ACTSN=----- PPMEASREQD= NO
8005558000 8005559999 dpcssn ssn    001-254-255
    SSN=255 CCGT=yes CGGTMOD=NO
    GTMODID=----- TESTMODE=off
    OPTSN=----- CGSELID=----- OPCS=-----
    ACTSN=----- PPMEASREQD= NO
9195551212 9195551212 dpcssn ssn    008-001-001
    SSN=222 CCGT=no CGGTMOD=NO
    GTMODID=----- TESTMODE=off
    OPTSN=----- CGSELID=----- OPCS=-----
    ACTSN=----- PPMEASREQD= NO
9194600000 9194600000 dpc      gt      001-255-252
    SSN=0   CCGT=no CGGTMOD=NO
    GTMODID=----- TESTMODE=off
    OPTSN=----- CGSELID=----- OPCS=-----
    ACTSN=----- PPMEASREQD= NO
9194610000 9194680000 dpcssn ssn    001-255-252
    SSN=222 CCGT=no CGGTMOD=NO
    GTMODID=----- TESTMODE=off
    OPTSN=----- CGSELID=----- OPCS=-----
    ACTSN=----- PPMEASREQD= NO
9762428487 9762428487 dpcssn ssn    001-254-255
    SSN=222 CCGT=no CGGTMOD=NO
    GTMODID=----- TESTMODE=off
    OPTSN=----- CGSELID=----- OPCS=-----
    ACTSN=----- PPMEASREQD= NO
9766423277 9766423277 dpcssn ssn    001-254-255
    SSN=222 CCGT=no CGGTMOD=NO
    GTMODID=----- TESTMODE=off
    OPTSN=----- CGSELID=----- OPCS=-----
    ACTSN=----- PPMEASREQD= NO
9769388928 9769388928 dpcssn ssn    001-254-255
    SSN=222 CCGT=no CGGTMOD=NO
    GTMODID=----- TESTMODE=off
    OPTSN=----- CGSELID=----- OPCS=-----
    ACTSN=----- PPMEASREQD= NO
  
```

Command Retrieved 12 Entries

Continue the procedure by performing one of these steps.

- If the range of GTAs, CGPA SSN, or CDPA SSNs will not be split in this procedure, continue the procedure by performing one of these steps.
 - If the GTT set type that contains the GTA entry that is being removed is not CDGTA, CGGTA, or Opcode, continue the procedure with 5.

- If the GTT set type that contains the GTA entry that is being removed is CDGTA, CGGTA, or OPCODE, continue the procedure with 4.
- If the range of GTAs, CGPA SSN, or CDPA SSNs will be split in this procedure, continue the procedure with 3.

3. If the `rtrv-gta` output in 2 shows that the maximum number of global title addresses is 1,000,000, do not perform this step

If the `rtrv-gta` output in 2 shows that the maximum number of global title addresses is either 269,999 or 400,000, and the number of global title addresses will not increase the number beyond the quantity shown in the `rtrv-gta` output in 2 when the range of GTAs, CGPA SSNs, or CDPA SSNs is split, do not perform this step.

If the `rtrv-gta` output in 2 shows that the maximum number of global title addresses is either 269,999 or 400,000, and the number of global title addresses will be more than the maximum number of global title addresses when the range of GTAs, CGPA SSNs, or CDPA SSNs is split, perform the [Enabling the XGTT Table Expansion Feature](#) procedure to enable the XGTT Table Expansion controlled feature for either 400,000 or 1,000,000 global title addresses as required.

Continue the procedure by performing one of these steps.

- If the GTT set type that contains the GTA entry that is being removed is not CDGTA, CGGTA, or OPCODE, continue the procedure with 5.
 - If the GTT set type that contains the GTA entry that is being removed is CDGTA, CGGTA, or OPCODE, continue the procedure with 4.
4. Display the GTT action paths in the database by entering the `rtrv-gttapath` command with these parameters.
- If the GTT set type is CDGTA, specify the `cdgttsn` parameter with the GTT set name shown in the `rtrv-gta` output in 2.
 - If the GTT set type is CGGTA, specify the `cggtsn` parameter with the GTT set name shown in the `rtrv-gta` output in 2.
 - If the GTT set type is OPCODE, specify the `cdgttsn` parameter with the GTT set name shown in the `rtrv-gta` output in 2.

For this example, enter this command.

```
rtrv-gttapath:cdgttsn=t800
```

This is an example of the possible output.

```
rlghncxa03w 10-07-25 09:43:31 GMT EAGLE5 42.0.0
```

GTPN	OPGTSN	CGGTSN	CDGTSN

path1	-----	-----	t800
	CDGTA = 3365840000		ECDGTA = 3365849999

```
GTT-PATH table is (10 of 10000) 1% full.
```

If entries are displayed, continue the procedure by performing one of these procedures.

- Perform the [Removing a GTT Action Path Entry](#) to remove all the entries shown in this step.
- Perform the [Changing a GTT Action Path Entry](#) to change the CDGTTSN, CGGTTSN, or OPCODE value to `none` or to another GTT set for all the entries shown in this step.

If no entries are displayed in this step, or if the GTT action paths have been removed or changed, continue the procedure with [5](#).

5. Remove the GTA information using the `dlt-gta` command.

The parameter combinations that can be used with the `dlt-gta` command are shown in these tables.

- [Table 4-35](#)
- [Table 4-36](#)
- [Table 4-37](#)

```
dlt-gta:gttsn=t800:gta=3365840000:egta=3365849999
```

When this command has successfully completed, this message appears.

```
rlghncxa03w 06-10-07 00:29:31 GMT EAGLE5 36.0.0
DLT-GTA: MASP A - COMPLTD
```

6. Verify the changes to the GTT set using the `rtrv-gta` command with the `gttsn` parameter value specified in [5](#).

If the `num` parameter is specified with the `rtrv-gta` command, and the value of the `num` parameter is greater than 1000, the `force=yes` parameter must be specified with the `rtrv-gta` command. For this example, enter this command.

```
rtrv-gta:gttsn=t800
```

This is an example of the possible output.

```
rlghncxa03w 10-07-07 00:28:31 GMT EAGLE5 42.0.0
GTTSN      NETDOM  SETTYPE  NDGT
t800      ansi    CDGTA    10

GTA TABLE IS 1 % FULL (17 of 269999)

START GTA  END GTA   XLAT  RI    PC
8005550000 8005551999 dpcssn ssn   001-254-255
          SSN=255 CCGT=no CGGTMOD=NO
          GTMODID=----- TESTMODE=off
          OPTSN=----- CGSELID=----- OPCSN=-----
          ACTSN=----- PPMEASREQD= NO
8005552000 8005553999 dpc    gt    001-254-255
          SSN=0   CCGT=no CGGTMOD=NO
          GTMODID=----- TESTMODE=off
          OPTSN=----- CGSELID=----- OPCSN=-----
          ACTSN=----- PPMEASREQD= NO
8005554000 8005555999 dpcngt gt    001-254-255
          SSN=--- CCGT=no CGGTMOD=NO
          GTMODID=----- TESTMODE=off
          OPTSN=----- CGSELID=----- OPCSN=gttset3
```

```
      ACTSN=----- PPMEASREQD= NO
8005556000 8005557999 dpcssn ssn    001-254-255
      SSN=255 CCGT=no CGGTMOD=NO
      GTMODID=----- TESTMODE=off
      OPTSN=----- CGSELID=----- OPCSN=-----
      ACTSN=----- PPMEASREQD= NO
8005558000 8005559999 dpcssn ssn    001-254-255
      SSN=255 CCGT=yes CGGTMOD=NO
      GTMODID=----- TESTMODE=off
      OPTSN=----- CGSELID=----- OPCSN=-----
      ACTSN=----- PPMEASREQD= NO
9195551212 9195551212 dpcssn ssn    008-001-001
      SSN=222 CCGT=no CGGTMOD=NO
      GTMODID=----- TESTMODE=off
      OPTSN=----- CGSELID=----- OPCSN=-----
      ACTSN=----- PPMEASREQD= NO
9194600000 9194600000 dpc    gt     001-255-252
      SSN=0   CCGT=no CGGTMOD=NO
      GTMODID=----- TESTMODE=off
      OPTSN=----- CGSELID=----- OPCSN=-----
      ACTSN=----- PPMEASREQD= NO
9194610000 9194680000 dpcssn ssn    001-255-252
      SSN=222 CCGT=no CGGTMOD=NO
      GTMODID=----- TESTMODE=off
      OPTSN=----- CGSELID=----- OPCSN=-----
      ACTSN=----- PPMEASREQD= NO
9762428487 9762428487 dpcssn ssn    001-254-255
      SSN=222 CCGT=no CGGTMOD=NO
      GTMODID=----- TESTMODE=off
      OPTSN=----- CGSELID=----- OPCSN=-----
      ACTSN=----- PPMEASREQD= NO
9766423277 9766423277 dpcssn ssn    001-254-255
      SSN=222 CCGT=no CGGTMOD=NO
      GTMODID=----- TESTMODE=off
      OPTSN=----- CGSELID=----- OPCSN=-----
      ACTSN=----- PPMEASREQD= NO
9769388928 9769388928 dpcssn ssn    001-254-255
      SSN=222 CCGT=no CGGTMOD=NO
      GTMODID=----- TESTMODE=off
      OPTSN=----- CGSELID=----- OPCSN=-----
      ACTSN=----- PPMEASREQD= NO
```

Command Retrieved 11 Entries

7. Backup the new changes using the `chg-db:action=backup:dest=fixed` command.

These messages should appear, the active Maintenance and Administration Subsystem Processor (MASP) appears first.

```
BACKUP (FIXED) : MASP A - Backup starts on active MASP.
BACKUP (FIXED) : MASP A - Backup on active MASP to fixed disk
complete.
BACKUP (FIXED) : MASP A - Backup starts on standby MASP.
```

BACKUP (FIXED) : MASP A - Backup on standby MASP to fixed disk
complete.

Figure 4-21 Remove Global Title Address Information - Sheet 1 of 2

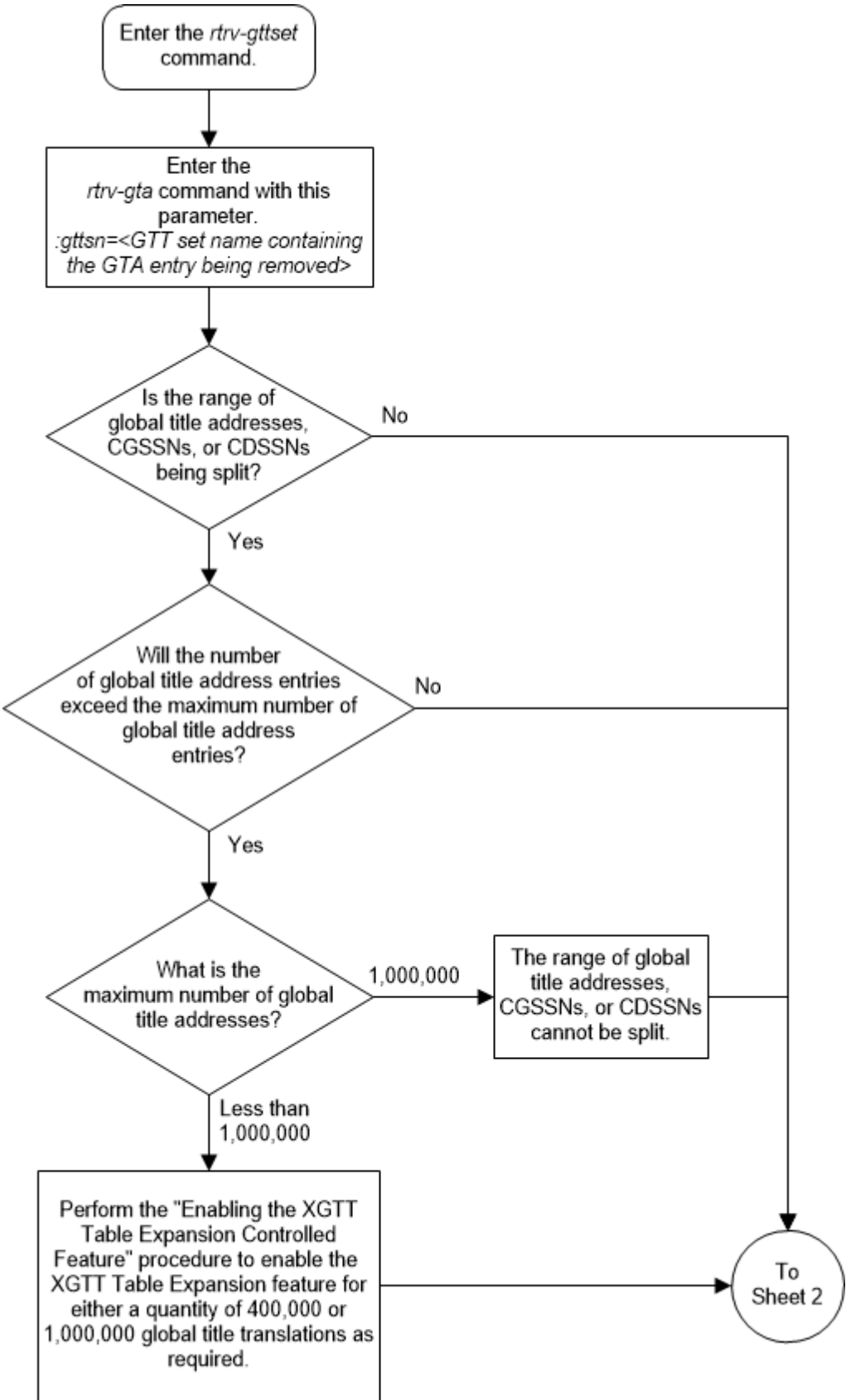
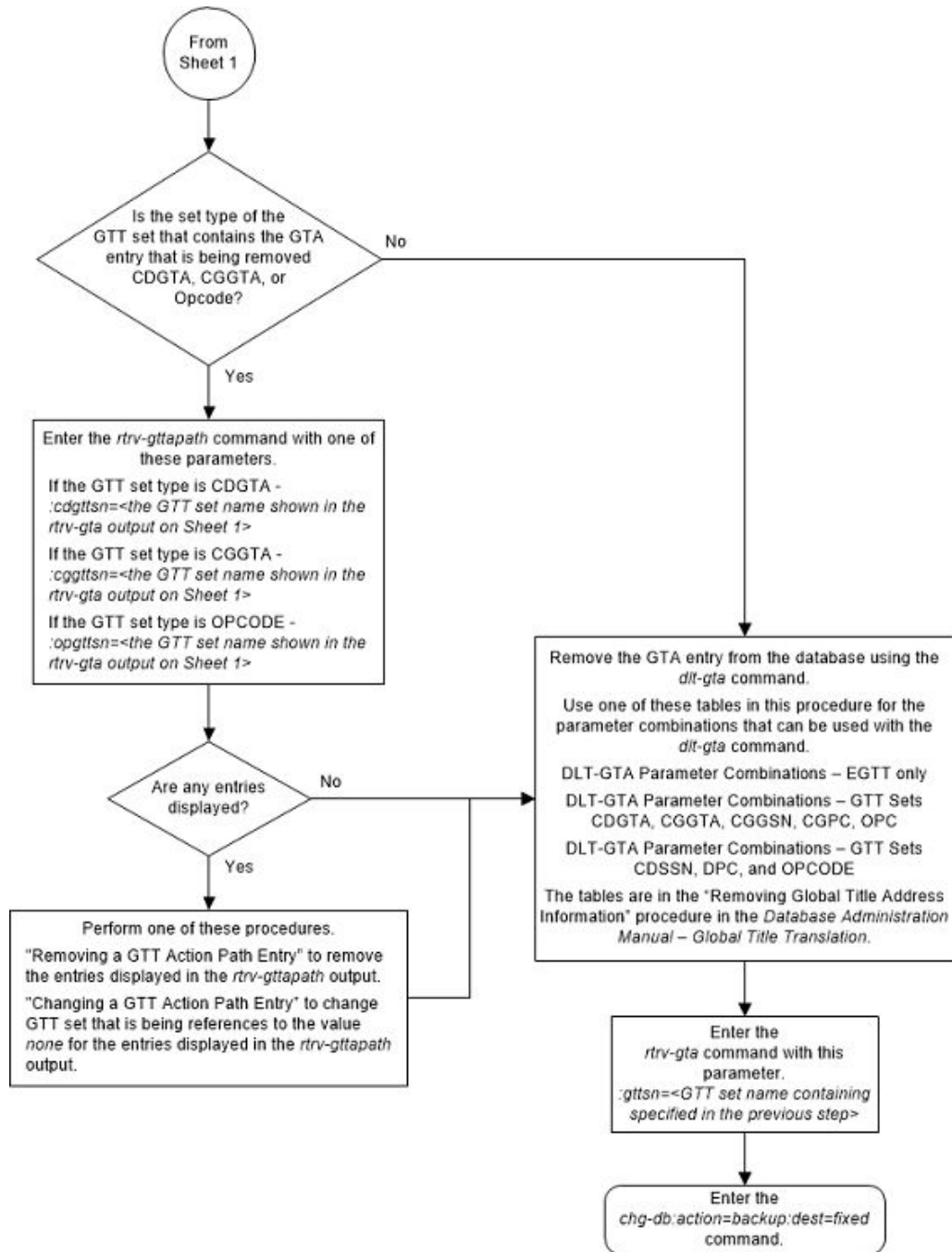

Figure 4-22 Remove Global Title Address Information - Sheet 2 of 2



Changing Global Title Address Information

This procedure is used to change existing global title address (GTA) information in the database using the `chg-gta` command.

The `chg-gta` command uses these parameters.

:gttsn – The GTT set name.

`:gta` – The start of global title address.

`:egta` – The end of global title address.

`:pc/pca/pci/pcn/pcn24` – The translated point code.

`:ssn` – The translated subsystem number.

`:ri` – The routing indicator.

`:xlat` – The translate indicator.

`:ccgt` – The cancel called global title indicator.

`:force` – The check mated application override.

`:actsn` – The name of the GTT action set that will be assigned to the GTA entry as shown in the `rtrv-gttaset` output.

`:gtmodid` – The name of the GT modification identifier that will be assigned to the GTA entry as shown in the `rtrv-gtmod` output and provisioned in the [Adding Global Title Modification Information](#) procedure. The GT modification identifier contains the information to modify the numbering plan, nature of address indicator, and the prefix or suffix digits in the called party address or calling party address portion of outbound MSUs.

`:ppmeasreqd` – This parameter specifies whether per-path measurements are required for the GTA entry.

`:mrnset` – The MRN set ID, shown in the `rtrv-mrn` command. The `mrnset` parameter can be specified only if the Flexible GTT Load Sharing feature is enabled. If the Flexible GTT Load Sharing feature is enabled and the `ri` parameter value will be `ri=gt` when this procedure is completed, and the original global title translation being changed in this procedure did not have an MRN set ID assigned to it, the `mrnset` parameter must be specified with the `chg-gta` command. The MRN set ID assigned to the global title translation in this step must contain the point code value that will be assigned to the global title translation being changed in this step.

`:mapset` – The MAP set ID, shown in the `rtrv-mrn` command. The `mapset` parameter can be specified only if the Flexible GTT Load Sharing feature is enabled. If the Flexible GTT Load Sharing feature is enabled and the `ri` parameter value will be `ri=ssn` when this procedure is completed, and the original global title translation being changed in this procedure did not have a MAP set ID assigned to it, the `mapset` parameter must be specified with the `chg-gta` command. The MAP set ID assigned to the global title translation in this step must contain the point code and SSN values that will be assigned to the global title translation being changed in this step.

The status of the Flexible GTT Load Sharing feature is shown in the `rtrv-ctrl-feat` output. To enable the Flexible GTT Load Sharing feature, perform [Activating the Flexible GTT Load Sharing Feature](#).

`:optsn` – The optional GTT set name shown in the `rtrv-gttset` output. [Table 4-38](#) shows the types of GTT sets that can be specified for the `optsn` parameter based on the type of GTT set that is specified for the `gttset` parameter and the features that are enabled and turned on.

Table 4-38 GTTSN and OPTSN Combinations

GTTSN Set Type	OPTSN Set Type
Origin-Based SCCP Routing Feature Enabled Only	
CDGTA	CGGTA, CGPC The OPC GTT set type can be specified with a CDGTA GTT set, but the OPC GTT set is specified with the <code>opcsn</code> parameter.
CGGTA	CGSSN
CGPC	CGSSN
CGSSN	The <code>optsn</code> parameter cannot be specified.
OPC	CGSSN
Flexible Linkset Optional Based Routing Enabled and Turned On Only	
CDGTA	CDGTA, DPC, CDSSN
CDSSN	CDSSN, DPC, CDGTA
DPC	DPC, CDSSN, CDGTA
Origin-Based SCCP Routing Enabled and Flexible Linkset Optional Based Routing Enabled and Turned On Only	
CDGTA	CDGTA, CGGTA, CGPC, CGSSN, CDSSN, DPC, OPC The OPC GTT set type can be specified with a CDGTA GTT set, but the OPC GTT set is specified with the <code>opcsn</code> parameter.
CGGTA	CDGTA, CGGTA, CGPC, CGSSN, OPC, CDSSN, DPC
CGPC	CDGTA, CGGTA, CGPC, CGSSN, OPC, CDSSN, DPC
CGSSN	CDGTA, CGGTA, CGPC, CGSSN, OPC, CDSSN, DPC
OPC	CDGTA, CGGTA, CGPC, CGSSN, CDSSN, DPC, OPC
CDSSN	CDGTA, CGGTA, CGPC, CGSSN, OPC, DPC, CDSSN
DPC	CDGTA, CGGTA, CGPC, CGSSN, OPC, CDSSN, DPC
Flexible Linkset Optional Based Routing and TCAP Opcode Based Routing Feature Enabled and Turned On Only	
CDGTA	CDGTA, OPCODE, DPC, CDSSN
CDSSN	CDSSN, OPCODE, DPC, CDGTA
OPCODE	OPCODE, CDSSN, DPC, CDGTA
DPC	DPC, OPCODE, CDSSN, CDGTA
Origin-Based SCCP Routing Enabled, Flexible Linkset Optional Based Routing and TCAP Opcode Based Routing Feature Enabled and Turned On	
CDGTA	CDGTA, CGGTA, CGPC, CGSSN, CDSSN, OPCODE, DPC, OPC The OPC GTT set type can be specified with a CDGTA GTT set, but the OPC GTT set is specified with the <code>opcsn</code> parameter.

Table 4-38 (Cont.) GTTSN and OPTSN Combinations

GTTSN Set Type	OPTSN Set Type
CGGTA	CDGTA, CGGTA, CGPC, CGSSN, CDSSN, OPCODE, OPC, DPC The <code>opcsn</code> parameter cannot be specified.
CGPC	CDGTA, CGGTA, CGPC, CGSSN, CDSSN, OPCODE, OPC, DPC The <code>opcsn</code> parameter cannot be specified.
CGSSN	CDGTA, CGGTA, CGPC, CGSSN, CDSSN, OPCODE, OPC, DPC The <code>opcsn</code> parameter cannot be specified.
OPC	CDGTA, CGGTA, CGPC, CGSSN, CDSSN, OPCODE, OPC, DPC
CDSSN	CDGTA, CGGTA, CGPC, CGSSN, CDSSN, OPCODE, DPC, OPC The OPC GTT set type can be specified with a CDSSN GTT set, but the OPC GTT set is specified with the <code>opcsn</code> parameter.
OPCODE	CDGTA, CGGTA, CGPC, CGSSN, CDSSN, OPCODE, DPC, OPC The OPC GTT set type can be specified with an OPCODE GTT set, but the OPC GTT set is specified with the <code>opcsn</code> parameter.
DPC	CDGTA, CGGTA, CGPC, CGSSN, CDSSN, OPCODE, DPC, OPC The OPC GTT set type can be specified with a DPC GTT set, but the OPC GTT set is specified with the <code>opcsn</code> parameter.

:`opcsn` – The OPC GTT set name shown in the `rtrv-gttset` output.

:`cgssn` – The CGPA subsystem number or the beginning value of a range of CGPA subsystem numbers

:`ecgssn` – The end value of a range of CGPA subsystem numbers

:`cgpc/cgpca/cgpci/cgpcn/cgpcn24` – The CGPA point code

:`opc/opca/opci/opcn/opcn24` – The originating point code

:`dpc/dpca/dpci/dpcn/dpcn24` – The destination point code

:`cdssn` – The CdPA subsystem number or the beginning value of a range of CdPA subsystem numbers

:`ecdssn` – The end value of a range of CdPA subsystem numbers

:`cgselid` – The CgPA selector ID

:`cdselid` – The CdPA selector ID

:`fallback` – The action to be taken when the final translation does not match while performing global title translation using a FLOBR-specific GTT mode.

`:testmode` – This parameter invokes a field-safe test tool to debug the rules used for the Flexible Linkset Optional Based Routing or TCAP Opcode Based Routing features.

`:cgcnvsn` – The CgPA conversion set name

`:family` – The ANSI TCAP family field in the incoming message

`:opcode` – The TCAP opcode field in the incoming message

`:pkgtype` – The TCAP package type. [Table 4-46](#) shows the ANSI and ITU TCAP package types.

`:acn` – The application context name (ACN) field in the ITU TCAP message

`:loopset` – The value of this parameter is the name of the `loopset` that is assigned to the GTA. This parameter can be specified only if the SCCP Loop Detection feature is enabled. Enter the `rtrv-loopset` command to verify that the SCCP Loop Detection feature is enabled. Perform the [Activating the SCCP Loop Detection Feature](#) procedure, if necessary.

`:cggtmod` – The calling party GT modification indicator. This parameter specifies whether or not calling party global title modification is required. The values for this parameter are `yes` (calling party global title modification is required) or `no` (calling party global title modification is not required). This parameter can be specified only if the AMGTT or AMGTT CgPA Upgrade feature is enabled. Enter the `rtrv-ctrl-feat` command to verify that either the AMGTT or AMGTT CgPA Upgrade feature is enabled. If the AMGTT or AMGTT CgPA Upgrade feature is not enabled, perform the [Activating the Advanced GT Modification Feature](#) procedure to enable the required feature.

`:split` – Split or change the range of global title addresses. If the `split=yes` parameter is specified, the existing range of global title addresses is split based on the values of the `gta` and `egta` parameters. New entries are created in the global title translation table for each new range created by the `split` parameter. The attributes of each new entry, other than the range of global title addresses, are the same as the original global title translation entry, if these values are not changed when the `chg-gta` command is executed. If other attributes are changed when the `chg-gta` command is executed, the changed values are in each new entry created by the `split` parameter.

If the `split=no` parameter is specified, the range of global title addresses is replaced with the new range of global title addresses specified by the `gta` and `egta` parameters.

The default value for the `split` parameter is `yes`.

Caution:

Changes to the range of global title addresses occur only if the both the `gta` and `egta` parameters are specified and the values for either of these parameters, or both parameters are different from the original values in the global title translation. If the `gta` and `egta` parameters are specified for the global title translation being changed, and you do not wish to change either of these values, make sure the `gta` and `egta` values shown in the `rtrv-gta` output for the global title translation being changed are specified in the `chg-gta` command.

The following examples illustrate how the `split` parameter works and ranges of global title addresses can be changed.

A global title translation entry in the database contains this range of global title addresses, 5556000 - 5558000.

```
rlghncxa03w 10-07-07 00:28:31 GMT EAGLE5 42.0.0
GTTSN      NETDOM  NDGT
tst1      ansi    7
GTA TABLE IS      (17 of 269999) 1 % FULL
START GTA  END GTA  XLAT  RI    PC
5556000    5558000    dpcssn ssn    001-255-252
          MAPSET=1      SSN=254 CCGT=no CGGTMOD=NO
          GTMODID=modid2    TESTMODE=off
          LOOPSET = rtp2      FALLBACK=sysdflt
          OPTSN=----- CGSELID=----- OPCS=gttset12
          ACTSN=----- PPMEASREQD= NO
```

The global title translation is changed with a new range of global title addresses, 5556800 - 5559000, and with the `split=no` parameter.

```
chg-gta:ttn=tst1:gta=5556800:egta=5559000:split=no
```

The range of global title addresses is changed to 5556800 - 5559000.

```
rlghncxa03w 10-07-07 00:28:31 GMT EAGLE5 42.0.0
GTTSN      NETDOM  NDGT
tst1      ansi    7
GTA TABLE IS      (17 of 269999) 1 % FULL
START GTA  END GTA  XLAT  RI    PC
5556800    5559000    dpcssn ssn    001-255-252
          MAPSET=1      SSN=254 CCGT=no CGGTMOD=NO
          GTMODID=modid2    TESTMODE=off
          LOOPSET = rtp2      FALLBACK=sysdflt
          OPTSN=----- CGSELID=----- OPCS=gttset12
          ACTSN=----- PPMEASREQD= NO
```

In this example, the range of global title addresses is made smaller by specifying the range of global title addresses 5556500 - 5557500, and with the `split=no` parameter.

```
chg-gta:ttn=tst1:gta=5556500:egta=5557500:split=no
```

```
rlghncxa03w 10-07-07 00:28:31 GMT EAGLE5 42.0.0
GTTSN      NETDOM  NDGT
tst1      ansi    7
GTA TABLE IS      1 % FULL (17 of 269999)
START GTA  END GTA  XLAT  RI    PC
5556500    5557500    dpcssn ssn    001-255-252
          MAPSET=1      SSN=254 CCGT=no CGGTMOD=NO
          GTMODID=modid2    TESTMODE=off
          LOOPSET = rtp2      FALLBACK=sysdflt
          OPTSN=----- CGSELID=----- OPCS=gttset12
          ACTSN=----- PPMEASREQD= NO
```

In this next example, the range of global title addresses is split with the `gta=5556900` and `egta=5557000` defining where the splits occur.

```
chg-gta:ttn=tst1:gta=5556900:egta=5557000
```

Since the default value for the `split` parameter is `yes`, the `split=yes` parameter does not have to be specified to split the range of global title addresses. When the `chg-gta` command is entered, three new global title translation entries with the new global title address ranges are created, and the original global title translation entry is removed from the database. Since the `gta` and `egta` parameter values specified in this example are within the original range of global title addresses, the original range of global title addresses is split into three new ranges. The `START GTA` value of the first new range is the original `START GTA` value and the `END GTA` value is the `gta` parameter value minus one. The `START GTA` value of the second new range is the `gta` parameter value and the `END GTA` value is the `egta` parameter value. The `START GTA` value of the third new range is the `egta` parameter value plus 1 and the `END GTA` value is the original `END GTA` value.

```
rlghncxa03w 10-07-07 00:28:31 GMT EAGLE5 42.0.0
GTTSN      NETDOM  NDGT
tst1      ansi    7
GTA TABLE IS  1 % FULL (17 of 269999)

START GTA  END GTA   XLAT  RI    PC
5556000   5556899   dpcssn ssn   001-255-252
          MAPSET=1      SSN=254 CCGT=no CGGTMOD=NO
          GTMODID=modid2  TESTMODE=off
          LOOPSET = rtp2    FALLBACK=sysdflt
          OPTSN=----- CGSELID=----- OPCSN=gttset12
          ACTSN=----- PPMEASREQD= NO
```

```
rlghncxa03w 10-07-07 00:28:31 GMT EAGLE5 42.0.0
GTTSN      NETDOM  NDGT
tst1      ansi    7
GTA TABLE IS  1 % FULL (17 of 269999)

START GTA  END GTA   XLAT  RI    PC
5556900   5557000   dpcssn ssn   001-255-252
          MAPSET=1      SSN=254 CCGT=no CGGTMOD=NO
          GTMODID=modid2  TESTMODE=off
          LOOPSET = rtp2    FALLBACK=sysdflt
          OPTSN=----- CGSELID=----- OPCSN=gttset12
          ACTSN=----- PPMEASREQD= NO
```

```
rlghncxa03w 10-07-07 00:28:31 GMT EAGLE5 42.0.0
GTTSN      NETDOM  NDGT
tst1      ansi    7
GTA TABLE IS  1 % FULL (17 of 269999)

START GTA  END GTA   XLAT  RI    PC
5557001   5558000   dpcssn ssn   001-255-252
          MAPSET=1      SSN=254 CCGT=no CGGTMOD=NO
          GTMODID=modid2  TESTMODE=off
          LOOPSET = rtp2    FALLBACK=sysdflt
```

```
OPTSN=----- CGSELID=----- OPCS=gttset12
ACTSN=----- PPMEASREQD= NO
```

In this next example, the global title translation containing the range of global title addresses 5557001 - 5558000 is split into two new ranges with the `gta=5557501` and `egta=5558000` defining where the split occurs.

```
chg-gta:ttn=tst1:gta=5557501:egta=5558000:split=yes
```

When the `chg-gta` command is entered, two new global title translation entries with the new global title address ranges are created, and the original global title translation entry is removed from the database. The `START GTA` value of the first new range is the original `START GTA` value and the `END GTA` value is the `gta` parameter value minus one. The `START GTA` value of the second new range is the `gta` parameter value and the `END GTA` value is the `egta` parameter value. In this example, the `egta` parameter is also the original `END GTA` value.

```
rlghncxa03w 10-07-07 00:28:31 GMT EAGLE5 42.0.0
GTTSN      NETDOM  NDGT
tst1      ansi    7
GTA TABLE IS 1 % FULL (17 of 269999)

START GTA  END GTA  XLAT  RI    PC
5557001    5557500    dpcssn ssn    001-255-252
MAPSET=1   SSN=254 CCGT=no CGGTMOD=NO
GTMODID=modid2 TESTMODE=off
LOOPSET = rtp2 FALLBACK=sysdflt
OPTSN=----- CGSELID=----- OPCS=gttset12
ACTSN=----- PPMEASREQD= NO
```

```
rlghncxa03w 10-07-07 00:28:31 GMT EAGLE5 42.0.0
GTTSN      NETDOM  NDGT
tst1      ansi    7
GTA TABLE IS 1 % FULL (17 of 269999)

START GTA  END GTA  XLAT  RI    PC
5557501    5558000    dpcssn ssn    001-255-252
MAPSET=1   SSN=254 CCGT=no CGGTMOD=NO
GTMODID=modid2 TESTMODE=off
LOOPSET = rtp2 FALLBACK=sysdflt
OPTSN=----- CGSELID=----- OPCS=gttset12
ACTSN=----- PPMEASREQD= NO
```

The range of global title addresses can be changed so long as the new range of global title addresses does not overlap an existing range of global title addresses.

For example, using the range of global title addresses from the previous examples, 5556000 - 5558000, you wish to extend the range of global title addresses to 5556000 - 5559000. The range of global title addresses can be extended to 5559000 by specifying the `egta=5559000` and `split=no` parameters with the `chg-gta` command. However, if another range of global title addresses begins with the value 5558500, the `egta=5559000` parameter cannot be specified with the `chg-gta` command as the new range created with the `egta=5559000` parameter would

overlap the range of global title addresses beginning with the value 5558500. In this situation, the maximum value for the `egta` parameter would be 5558499.

 **Note:**

The command line on the terminal can contain up to 150 characters. If the parameters and values specified with the `chg-gta` command are too long to fit on the `chg-gta` command line, perform the `chg-gta` command as many times as necessary to complete the GTA entry.

The GTT set name (`gttsn`) must be specified and match that of an existing GTT set name. Use the `rtrv-gttset` command to view the GTT set names. If the specified GTT set is an ANSI set, the `pc` or `pca` value must be a valid ANSI point code. If the specified GTT set is an ITU set, the `pci`, `pcn`, or `pcn24` value must be a valid ITU point code. The point code (PC) must be a full point code and cannot be out of range. If the ANSI/ITU SCCP Conversion feature is enabled, the domain (ANSI or ITU) of the GTT set name and point code do not have to be the same.

 **Note:**

See Chapter 2, Configuring Destination Tables in *Database Administration - SS7 User's Guide* for a definition of the point code types that are used on the EAGLE and for a definition of the different formats that can be used for ITU national point codes.

If the end of the global title address (`EGTA`) parameter is specified, `GTA` and `EGTA` must have the same number of digits, but `EGTA` must be larger than `GTA`. The range, as specified by the start and end global title addresses, must be in the database for the specified translation type. Each range may be contained completely within a previously defined range, in which case splitting is performed. However, if the ranges overlap, splitting cannot occur, and the `chg-gta` command is rejected with this message.

```
E2401 Cmd Rej:GTA range overlaps a current range
```

Along with error message 2401, a list of the overlapped global title addresses is displayed as shown in the following example.

```
rlghncxa03w 09-05-07 00:28:31 GMT EAGLE5 41.0.0
The following GTA ranges overlap the input GTA range
```

START GTA	END GTA
8005550000	8005551999
8005552000	8005553999
8005554000	8005555999

```
CHG-GTA: MASP A - Command Aborted
```

If a point code is the STP's True PC, then the value of the `XLAT` parameter must be set to `DPCSSN` and the value of the `RI` parameter must be set to `SSN`. If the `SSN` parameter is specified and a point code is the STP's True PC, then the subsystem

number specified must exist in the SS-APPL table. This can be verified with the `rtrv-ss-appl` command. To execute the `rtrv-ss-appl` command, these features must be enabled, and turned on if necessary.

- LNP - shown by the entry `LNP TNs` with a quantity greater than zero in the `rtrv-ctrl-feat` command output
- ATINP - shown by the entry `ATINP` in the `rtrv-ctrl-feat` command output with the status set to `on`
- EIR - shown by the entry `EIR` in the `rtrv-ctrl-feat` command output as being permanently or temporarily enabled and with the status set to `on`.
- INP - shown by the entry `INP` in the `rtrv-ctrl-feat` command output with the status set to `on`.
- V-FLEX - shown by the entry `VFLEX` in the `rtrv-ctrl-feat` command output with the status set to `on`.
- ANSI-41 INP Query - shown by the entry `ANSI-41 INP Query` in the `rtrv-ctrl-feat` command output with the status set to `on`.
- ANSI41 AIQ - shown by the entry `ANSI41 AIQ` in the `rtrv-ctrl-feat` command output.

 **Note:**

The Local Number Portability (LNP), Equipment Identity Register (EIR), INAP Number Portability (INP), V-Flex, ATINP, ANSI41 AIQ, or ANSI-41 INP Query features must be purchased before you can enable the LNP, ATINP, or ANSI41 AIQ features, or enable and turn on the EIR, INP, V-Flex, or ANSI-41 INP Query features. If you are not sure whether you have purchased the LNP, EIR, or INP, V-Flex, ATINP, or ANSI-41 INP Query feature, contact your Oracle Sales Representative or Account Representative. Once the LNP, ATINP, or ANSI41 AIQ feature is enabled with the `enable-ctrl-feat` command, or the EIR, INP, V-Flex, and ANSI-41 INP Query features are turned on with the `chg-ctrl-feat` command, they cannot be turned off or disabled.

A point code must exist as a destination in the route table or reside in a cluster that exists as a destination in the route table (for global title routing) unless the point code is the STP's True PC.

If a final GTT is specified (`ri=ssn`) with the `xlat=dpc` parameter, and the value of the `force` parameter is `no`, the point code must be in the Remote Point Code/Mated Application table. Verify this by entering the `rtrv-map` command. If this point code and subsystem number is not defined as a mated application, perform one of these procedures to add the point code and subsystem number to the database as a mated application:

- [Provisioning a Solitary Mated Application](#)
- [Provisioning a Dominant Mated Application](#)
- [Provisioning a Load Shared Mated Application](#)
- [Provisioning a Combined Dominant/Load Shared Mated Application](#)

The point code and subsystem number do not have to be in the mated application table when the `chg-gta` command is executed when these parameters are specified with the `chg-gta` command.

- `ri=gt`
- `xlat=dpcssn` and `ri=ssn` (provided the point code value is not the STP's true point code)

If the point code and subsystem are not in the mated application table when either of these parameters are specified with the `chg-gta` command, the EAGLE creates a solitary mated application in the mated application table using the point code and subsystem values specified in the `chg-gta` command.

If the `xlat=none` parameter is specified for a global title translation, the global title translation entry can contain any data except for the routing data defined by these parameters.

- `pc/pca/pci/pcn/pcn24`
- `ssn`
- `ri`
- `force=yes`

The [GTA Entries with the XLAT=NONE Parameter](#) part of the [GTT Actions](#) section described the behavior of the `xlat=none` parameter.

The following tables show the valid parameter combinations that can be used with the `chg-gta` command.

- [Table 4-39](#)
- [Table 4-40](#)
- [Table 4-41](#)
- [Table 4-42](#)
- [Table 4-43](#)
- [Table 4-44](#)
- [Table 4-45](#)
- [Table 4-46](#)
- [Table 4-47](#)

The GTT table may not be full.

The values specified for the `gta` and `egta` parameters can be decimal digits (0-9) or hexadecimal digits (0-9, a-f, A-F). Hexadecimal digits can be specified only if the Hex Digit Support for GTT feature is enabled. Verify the status of the Hex Digit Support for GTT feature with the `rtrv-ctrl-feat` command. Refer to the [Hex Digit Support for GTT](#) section for more information on this feature. If the Hex Digit Support for GTT feature is not enabled, perform the [Activating the Hex Digit Support for GTT Feature](#) procedure to enable the Hex Digit Support for GTT feature.

Canceling the RTRV-GTA Command

Because the `rtrv-gta` command used in this procedure can output information for a long period of time, the `rtrv-gta` command can be canceled and the output to

the terminal stopped. There are three ways that the `rtrv-gta` command can be canceled.

- Press the F9 function key on the keyboard at the terminal where the `rtrv-gta` command was entered.
- Enter the `canc-cmd` without the `trm` parameter at the terminal where the `rtrv-gta` command was entered.
- Enter the `canc-cmd:trm=<xx>`, where `<xx>` is the terminal where the `rtrv-gta` command was entered, from another terminal other than the terminal where the `rtrv-gta` command was entered. To enter the `canc-cmd:trm=<xx>` command, the terminal must allow Security Administration commands to be entered from it and the user must be allowed to enter Security Administration commands. The terminal's permissions can be verified with the `rtrv-secu-trm` command. The user's permissions can be verified with the `rtrv-user` or `rtrv-secu-user` commands.

For more information about the `canc-cmd` command, go to *Commands User's Guide*.

Table 4-39 GTA Parameter Combinations - No SETTYPE Column in RTRV-GTTSET Output

Mandatory Parameters	
GTTSN – The GTT set name from the GTTSN column of the <code>rtrv-gttset</code> output and from the GTTSN column of the <code>rtrv-gta</code> output.	
GTA – The GTA value assigned to the GTTSN value in the <code>rtrv-gta</code> output.	
If only the EGTT feature is on, the SETTYPE column is not shown in the <code>rtrv-gttset</code> output.	
Optional Parameters	
EGTA – 1 - 21 digits or 1 - 21 hexadecimal digits.	
Default = same as the GTA value.	
Hexadecimal digits (0-9, a-f, A-F) can be specified for the <code>egta</code> parameters only if the Hex Digit support for GTT feature is enabled.	
The length of the EGTA value must be the same as the GTA value.	
There are other optional parameters that can be used with this entry. Refer to Table 4-48 for these parameters. At least one optional parameter must be specified with the <code>chg-gta</code> command. Unless a default value is shown for a parameter in Table 4-48 , the value of any optional parameter that is not specified with the <code>chg-gta</code> command is not changed.	

Table 4-40 GTTSN = CDGTA GTT Set Parameter Combinations

XLAT=DPCNGT, DPCSSN, or DPC	XLAT=NONE
Mandatory Parameters	
GTTSN – The GTT set name from the GTTSN column of the <code>rtrv-gttset</code> output containing the value CDGTA in the SETTYPE column and from the GTTSN column of the <code>rtrv-gta</code> output.	GTTSN – The GTT set name from the GTTSN column of the <code>rtrv-gttset</code> output containing the value CDGTA in the SETTYPE column and from the GTTSN column of the <code>rtrv-gta</code> output.
GTA – The GTA value assigned to the GTTSN value in the <code>rtrv-gta</code> output.	GTA – The GTA value assigned to the GTTSN value in the <code>rtrv-gta</code> output.
Optional Parameters	

Table 4-40 (Cont.) GTTSN = CDGTA GTT Set Parameter Combinations

XLAT=DPCNGT, DPCSSN, or DPC	XLAT=NONE
<p>EGTA – 1 - 21 digits or 1 - 21 hexadecimal digits.</p> <p>Default = same as the GTA value.</p> <p>Hexadecimal digits (0-9, a-f, A-F) can be specified for the <code>egta</code> parameters only if the Hex Digit support for GTT feature is enabled.</p> <p>The length of the EGTA value must be the same as the GTA value.</p>	<p>EGTA – 1 - 21 digits or 1 - 21 hexadecimal digits.</p> <p>Default = same as the GTA value.</p> <p>Hexadecimal digits (0-9, a-f, A-F) can be specified for the <code>egta</code> parameters only if the Hex Digit support for GTT feature is enabled.</p> <p>The length of the EGTA value must be the same as the GTA value. These parameters cannot be specified with the <code>xlat=none</code> parameter.</p> <ul style="list-style-type: none"> • <code>pc/pca/pci/pcn/pcn24</code> • <code>ssn</code> • <code>ri</code> • <code>force=yes</code>
<p>OPTSN – The GTT set name from the GTTSN column of the <code>rtrv-gttset</code> output, or the value <code>none</code>. The value <code>none</code> removes the OPTSN value from the GTA entry. Refer to Table 4-38 for the valid GTT set types that can be specified.</p>	
<p>The current value of this parameter must be changed to the value <code>none</code> before the parameter value can be changed to another value that is not <code>none</code>. The new value for this parameter cannot be the <code>gttsn</code> value specified with the <code>chg-gta</code> command.</p>	
<p>OPCSN – The GTT set name from the GTTSN column of the <code>rtrv-gttset</code> output containing the value <code>OPC</code> in the SETTYPE column, or the value <code>none</code>. The value <code>none</code> removes the OPCS value from the GTA entry.</p>	
<p>There are other optional parameters that can be used with this entry. Refer to Table 4-48 for these parameters. At least one optional parameter must be specified with the <code>chg-gta</code> command. Unless a default value is shown for a parameter in Table 4-48, the value of any optional parameter that is not specified with the <code>chg-gta</code> command is not changed.</p>	
<p>Note: When the <code>xlat</code> parameter value is changed from <code>dpcngt</code>, <code>dpcssn</code>, or <code>dpc</code>, to <code>none</code>, all the optional parameter values that are not specified with the <code>chg-gta</code> command are not changed. However, these changes are made.</p>	
<ul style="list-style-type: none"> • The <code>PC</code> and <code>SSN</code> values are removed from the GTA entry. • The <code>CCGT</code> value is removed from the GTA entry and the <code>CCGT</code> field is not shown in the <code>rtrv-gta</code> output. • If the original <code>RI</code> value for the GTA entry was <code>SSN</code> and a <code>MAP</code> set was assigned to the GTA entry, the <code>MAPSET</code> value is not changed and the <code>MRNSET=DFLT</code> entry is assigned to the GTA entry. The <code>MRNSET=DFLT</code> entry is shown in the <code>rtrv-gta</code> output. • If the original <code>RI</code> value for the GTA entry was <code>GT</code> and an <code>MRN</code> set was assigned to the GTA entry, the <code>MRNSET</code> value is not changed and the <code>MAPSET=DFLT</code> entry is assigned to the GTA entry. The <code>MAPSET=DFLT</code> entry is shown in the <code>rtrv-gta</code> output. 	

Table 4-41 GTTSN = CGGTA GTT Set Parameter Combinations

XLAT=DPCNGT, DPCSSN, or DPC	XLAT=NONE
Mandatory Parameters	
<p>GTTSN – The GTT set name from the GTTSN column of the <code>rtrv-gttset</code> output containing the value CGGTA in the SETTYPE column and from the GTTSN column of the <code>rtrv-gta</code> output.</p> <p>GTA – The GTA value assigned to the GTTSN value in the <code>rtrv-gta</code> output.</p>	<p>GTTSN – The GTT set name from the GTTSN column of the <code>rtrv-gttset</code> output containing the value CGGTA in the SETTYPE column and from the GTTSN column of the <code>rtrv-gta</code> output.</p> <p>GTA – The GTA value assigned to the GTTSN value in the <code>rtrv-gta</code> output.</p>
Optional Parameters	
<p>EGTA – 1 - 21 digits or 1 - 21 hexadecimal digits.</p> <p>Default = same as the GTA value.</p> <p>Hexadecimal digits (0-9, a-f, A-F) can be specified for the <code>egta</code> parameters only if the Hex Digit support for GTT feature is enabled.</p> <p>The length of the EGTA value must be the same as the GTA value.</p>	<p>EGTA – 1 - 21 digits or 1 - 21 hexadecimal digits.</p> <p>Default = same as the GTA value.</p> <p>Hexadecimal digits (0-9, a-f, A-F) can be specified for the <code>egta</code> parameters only if the Hex Digit support for GTT feature is enabled.</p> <p>The length of the EGTA value must be the same as the GTA value. These parameters cannot be specified with the <code>xlat=none</code> parameter.</p>
<ul style="list-style-type: none"> • <code>pc/pca/pci/pcn/pcn24</code> • <code>ssn</code> • <code>ri</code> • <code>force=yes</code> 	
<p>OPTSN – The GTT set name from the GTTSN column of the <code>rtrv-gttset</code> output, or the value <code>none</code>. The value <code>none</code> removes the OPTSN value from the GTA entry. Refer to Table 4-38 for the valid GTT set types that can be specified.</p> <p>The current value of this parameter must be changed to the value <code>none</code> before the parameter value can be changed to another value that is not <code>none</code>. The new value for this parameter cannot be the <code>gttsn</code> value specified with the <code>chg-gta</code> command.</p>	
<p>There are other optional parameters that can be used with this entry. Refer to Table 4-48 for these parameters. At least one optional parameter must be specified with the <code>chg-gta</code> command. Unless a default value is shown for a parameter in Table 4-48, the value of any optional parameter that is not specified with the <code>chg-gta</code> command is not changed.</p>	

Table 4-41 (Cont.) GTTSN = CGGTA GTT Set Parameter Combinations

XLAT=DPCNGT, DPCSSN, or DPC	XLAT=NONE
<p>Note: When the <code>xlat</code> parameter value is changed from <code>dpcngt</code>, <code>dpcssn</code>, or <code>dpc</code>, to <code>none</code>, all the optional parameter values that are not specified with the <code>chg-gta</code> command are not changed. However, these changes are made.</p> <ul style="list-style-type: none"> The <code>PC</code> and <code>SSN</code> values are removed from the <code>GTA</code> entry. The <code>CCGT</code> value is removed from the <code>GTA</code> entry and the <code>CCGT</code> field is not shown in the <code>rtrv-gta</code> output. If the original <code>RI</code> value for the <code>GTA</code> entry was <code>SSN</code> and a <code>MAP</code> set was assigned to the <code>GTA</code> entry, the <code>MAPSET</code> value is not changed and the <code>MRNSET=DFLT</code> entry is assigned to the <code>GTA</code> entry. The <code>MRNSET=DFLT</code> entry is shown in the <code>rtrv-gta</code> output. If the original <code>RI</code> value for the <code>GTA</code> entry was <code>GT</code> and an <code>MRN</code> set was assigned to the <code>GTA</code> entry, the <code>MRNSET</code> value is not changed and the <code>MAPSET=DFLT</code> entry is assigned to the <code>GTA</code> entry. The <code>MAPSET=DFLT</code> entry is shown in the <code>rtrv-gta</code> output. 	

Table 4-42 GTTSN = CGPC GTT Set Parameter Combinations

XLAT=DPCNGT, DPCSSN, or DPC	XLAT=NONE
Mandatory Parameters	
<p>GTTSN – The <code>GTT</code> set name from the <code>GTTSN</code> column of the <code>rtrv-gttset</code> output containing the value <code>CGPC</code> in the <code>SETTYPE</code> column and from the <code>GTTSN</code> column of the <code>rtrv-gta</code> output.</p> <p>CGPC/CGPCA/CGPCI/CGPCN/CGPCN24 – The <code>CGPC</code> value assigned to the <code>GTTSN</code> value in the <code>rtrv-gta</code> output. (See Note 1)</p>	<p>GTTSN – The <code>GTT</code> set name from the <code>GTTSN</code> column of the <code>rtrv-gttset</code> output containing the value <code>CGPC</code> in the <code>SETTYPE</code> column and from the <code>GTTSN</code> column of the <code>rtrv-gta</code> output.</p> <p>CGPC/CGPCA/CGPCI/CGPCN/CGPCN24 – The <code>CGPC</code> value assigned to the <code>GTTSN</code> value in the <code>rtrv-gta</code> output. (See Note 1)</p>
Optional Parameters	
<p>OPTSN – The <code>GTT</code> set name from the <code>GTTSN</code> column of the <code>rtrv-gttset</code> output, or the value <code>none</code>. The value <code>none</code> removes the <code>OPTSN</code> value from the <code>GTA</code> entry. Refer to Table 4-38 for the valid <code>GTT</code> set types that can be specified.</p> <p>The current value of this parameter must be changed to the value <code>none</code> before the parameter value can be changed to another value that is not <code>none</code>. The new value for this parameter cannot be the <code>gttsn</code> value specified with the <code>chg-gta</code> command.</p> <p>There are other optional parameters that can be used with this entry. Refer to Table 4-48 for these parameters. At least one optional parameter must be specified with the <code>chg-gta</code> command. Unless a default value is shown for a parameter in Table 4-48, the value of any optional parameter that is not specified with the <code>chg-gta</code> command is not changed.</p> <p>The <code>egta</code> and <code>split</code> parameters cannot be specified with this entry.</p>	<p>These parameters cannot be specified with the <code>xlat=none</code> parameter.</p> <ul style="list-style-type: none"> <code>pc/pca/pci/pcn/pcn24</code> <code>ssn</code> <code>ri</code> <code>force=yes</code>

Table 4-42 (Cont.) GTTSN = CGPC GTT Set Parameter Combinations

XLAT=DPCNGT, DPCSSN, or DPC	XLAT=NONE
Note:	
<ol style="list-style-type: none"> The <code>cgpc/cgpca/cgpci/cgpcn/cgpcn24</code> parameters are used to assign either ANSI, ITU-I, ITU-I spare, 14-bit ITU-N, 14-bit ITU-N spare, or 24-bit ITU-N point codes as the CGPC parameter values. <ul style="list-style-type: none"> <code>cgpc/cgpca</code> = ANSI point code <code>cgpci</code> = ITU-I or ITU-I spare point code <code>cgpcn</code> = 14-bit ITU-N or 14-bit ITU-N spare point code <code>cgpcn24</code> = 24-bit ITU-N point code. When the <code>xlat</code> parameter value is changed from <code>dpcngt</code>, <code>dpcssn</code>, or <code>dpc</code>, to <code>none</code>, all the optional parameter values that are not specified with the <code>chg-gta</code> command are not changed. However, these changes are made. <ul style="list-style-type: none"> The PC and SSN values are removed from the GTA entry. The CCGT value is removed from the GTA entry and the CCGT field is not shown in the <code>rtrv-gta</code> output. If the original RI value for the GTA entry was SSN and a MAP set was assigned to the GTA entry, the MAPSET value is not changed and the MRNSET=DFLT entry is assigned to the GTA entry. The MRNSET=DFLT entry is shown in the <code>rtrv-gta</code> output. If the original RI value for the GTA entry was GT and an MRN set was assigned to the GTA entry, the MRNSET value is not changed and the MAPSET=DFLT entry is assigned to the GTA entry. The MAPSET=DFLT entry is shown in the <code>rtrv-gta</code> output. 	

Table 4-43 GTTSN = CGSSN GTT Set Parameter Combinations

XLAT=DPCNGT, DPCSSN, or DPC	XLAT=NONE
Mandatory Parameters	
GTTSN – The GTT set name from the GTTSN column of the <code>rtrv-gttset</code> output containing the value CGSSN in the SETTYPE column and from the GTTSN column of the <code>rtrv-gta</code> output.	GTTSN – The GTT set name from the GTTSN column of the <code>rtrv-gttset</code> output containing the value CGSSN in the SETTYPE column and from the GTTSN column of the <code>rtrv-gta</code> output.
CGSSN – The CGSSN value assigned to the GTTSN value in the <code>rtrv-gta</code> output.	CGSSN – The CGSSN value assigned to the GTTSN value in the <code>rtrv-gta</code> output.
Optional Parameters	
ECGSSN – 0 - 255. The ECGSSN value must be greater than the CGSSN value.	ECGSSN – 0 - 255. Default value – no ECGSSN value is specified. The ECGSSN value must be greater than the CGSSN value. These parameters cannot be specified with the <code>xlat=none</code> parameter. <ul style="list-style-type: none"> <code>pc/pca/pci/pcn/pcn24</code> <code>ssn</code> <code>ri</code> <code>force=yes</code>

Table 4-43 (Cont.) GTTSN = CGSSN GTT Set Parameter Combinations

XLAT=DPCNGT, DPCSSN, or DPC	XLAT=NONE
<p>OPTSN – The GTT set name from the GTTSN column of the <code>rtrv-gttset</code> output, or the value <code>none</code>. The value <code>none</code> removes the OPTSN value from the GTA entry. Refer to Table 4-38 for the valid GTT set types that can be specified.</p>	
<p>The current value of this parameter must be changed to the value <code>none</code> before the parameter value can be changed to another value that is not <code>none</code>. The new value for this parameter cannot be the <code>gttsn</code> value specified with the <code>chg-gta</code> command.</p>	
<p>There are other optional parameters that can be used with this entry. Refer to Table 4-48 for these parameters. At least one optional parameter must be specified with the <code>chg-gta</code> command. Unless a default value is shown for a parameter in Table 4-48, the value of any optional parameter that is not specified with the <code>chg-gta</code> command is not changed.</p>	
<p>The <code>egta</code> and <code>split</code> parameters cannot be specified with this entry.</p>	
<p>Note: When the <code>xlat</code> parameter value is changed from <code>dpcngt</code>, <code>dpcssn</code>, or <code>dpc</code>, to <code>none</code>, all the optional parameter values that are not specified with the <code>chg-gta</code> command are not changed. However, these changes are made.</p>	
<ul style="list-style-type: none"> • The PC and SSN values are removed from the GTA entry. • The CCGT value is removed from the GTA entry and the CCGT field is not shown in the <code>rtrv-gta</code> output. • If the original RI value for the GTA entry was SSN and a MAP set was assigned to the GTA entry, the MAPSET value is not changed and the MRNSET=DFLT entry is assigned to the GTA entry. The MRNSET=DFLT entry is shown in the <code>rtrv-gta</code> output. • If the original RI value for the GTA entry was GT and an MRN set was assigned to the GTA entry, the MRNSET value is not changed and the MAPSET=DFLT entry is assigned to the GTA entry. The MAPSET=DFLT entry is shown in the <code>rtrv-gta</code> output. 	

Table 4-44 GTTSN = OPC GTT Set Parameter Combinations

XLAT=DPCNGT, DPCSSN, or DPC	XLAT=NONE
<p>Mandatory Parameters</p>	
<p>GTTSN – The GTT set name from the GTTSN column of the <code>rtrv-gttset</code> output containing the value OPC in the SETTYPE column and from the GTTSN column of the <code>rtrv-gta</code> output.</p>	<p>GTTSN – The GTT set name from the GTTSN column of the <code>rtrv-gttset</code> output containing the value OPC in the SETTYPE column and from the GTTSN column of the <code>rtrv-gta</code> output.</p>
<p>OPC/OPCA/OPCI/OPCN/OPCN24 – The OPC value assigned to the GTTSN value in the <code>rtrv-gta</code> output. (See Note 1)</p>	<p>OPC/OPCA/OPCI/OPCN/OPCN24 – The OPC value assigned to the GTTSN value in the <code>rtrv-gta</code> output. (See Note 1)</p>
<p>Optional Parameters</p>	

Table 4-44 (Cont.) GTTSN = OPC GTT Set Parameter Combinations

XLAT=DPCNGT, DPCSSN, or DPC	XLAT=NONE
<p>OPTSN – The GTT set name from the GTTSN column of the <code>rtrv-gttset</code> output, or the value <code>none</code>. The value <code>none</code> removes the OPTSN value from the GTA entry. Refer to Table 4-38 for the valid GTT set types that can be specified.</p> <p>The current value of this parameter must be changed to the value <code>none</code> before the parameter value can be changed to another value that is not <code>none</code>. The new value for this parameter cannot be the <code>gttsn</code> value specified with the <code>chg-gta</code> command.</p>	<p>These parameters cannot be specified with the <code>xlat=none</code> parameter.</p> <ul style="list-style-type: none"> • <code>pc/pca/pci/pcn/pcn24</code> • <code>ssn</code> • <code>ri</code> • <code>force=yes</code>
<p>There are other optional parameters that can be used with this entry. Refer to Table 4-48 for these parameters. At least one optional parameter must be specified with the <code>chg-gta</code> command. Unless a default value is shown for a parameter in Table 4-48, the value of any optional parameter that is not specified with the <code>chg-gta</code> command is not changed.</p> <p>The <code>egta</code> and <code>split</code> parameters cannot be specified with this entry.</p>	
<p>Note:</p>	
<ol style="list-style-type: none"> 1. The <code>opc/opca/opci/opcn/opcn24</code> parameters are used to assign either ANSI, ITU-I, ITU-I spare, 14-bit ITU-N, 14-bit ITU-N spare, or 24-bit ITU-N point codes as the OPC parameter values. <ul style="list-style-type: none"> • <code>opc/opca</code> = ANSI point code • <code>opci</code> = ITU-I or ITU-I spare point code • <code>opcn</code> = 14-bit ITU-N or 14-bit ITU-N spare point code • <code>opcn24</code> = 24-bit ITU-N point code. 2. When the <code>xlat</code> parameter value is changed from <code>dpcngt</code>, <code>dpcssn</code>, or <code>dpc</code>, to <code>none</code>, all the optional parameter values that are not specified with the <code>chg-gta</code> command are not changed. However, these changes are made. <ul style="list-style-type: none"> • The PC and SSN values are removed from the GTA entry. • The CCGT value is removed from the GTA entry and the CCGT field is not shown in the <code>rtrv-gta</code> output. • If the original RI value for the GTA entry was SSN and a MAP set was assigned to the GTA entry, the MAPSET value is not changed and the MRNSET=DFLT entry is assigned to the GTA entry. The MRNSET=DFLT entry is shown in the <code>rtrv-gta</code> output. • If the original RI value for the GTA entry was GT and an MRN set was assigned to the GTA entry, the MRNSET value is not changed and the MAPSET=DFLT entry is assigned to the GTA entry. The MAPSET=DFLT entry is shown in the <code>rtrv-gta</code> output. 	

Table 4-45 GTTSN = CDSSN GTT Set Parameter Combinations

XLAT=DPCNGT, DPCSSN, or DPC	XLAT=NONE
<p>Mandatory Parameters</p>	

Table 4-45 (Cont.) GTTSN = CDSSN GTT Set Parameter Combinations

XLAT=DPCNGT, DPCSSN, or DPC	XLAT=NONE
<p>GTTSN – The GTT set name from the GTTSN column of the <code>rtrv-gttset</code> output containing the value CDSSN in the SETTYPE column and from the GTTSN column of the <code>rtrv-gta</code> output.</p>	<p>GTTSN – The GTT set name from the GTTSN column of the <code>rtrv-gttset</code> output containing the value CDSSN in the SETTYPE column and from the GTTSN column of the <code>rtrv-gta</code> output.</p>
<p>CDSSN – The CDSSN value assigned to the GTTSN value in the <code>rtrv-gta</code> output.</p>	<p>CDSSN – The CDSSN value assigned to the GTTSN value in the <code>rtrv-gta</code> output.</p>
<p>Optional Parameters</p>	
<p>ECDSSN – 0 - 255. The ECDSSN value must be greater than the CDSSN value.</p>	<p>ECDSSN – 0 - 255. Default value – no ECDSSN value is specified. The ECDSSN value must be greater than the CDSSN value. These parameters cannot be specified with the <code>xlat=none</code> parameter.</p> <ul style="list-style-type: none"> • <code>pc/pca/pci/pcn/pcn24</code> • <code>ssn</code> • <code>ri</code> • <code>force=yes</code>
<p>OPTSN – The GTT set name from the GTTSN column of the <code>rtrv-gttset</code> output, or the value <code>none</code>. The value <code>none</code> removes the OPTSN value from the GTA entry. Refer to Table 4-38 for the valid GTT set types that can be specified.</p>	
<p>The current value of this parameter must be changed to the value <code>none</code> before the parameter value can be changed to another value that is not <code>none</code>. The new value for this parameter cannot be the <code>gttsn</code> value specified with the <code>chg-gta</code> command.</p>	
<p>OPCSN – The GTT set name from the GTTSN column of the <code>rtrv-gttset</code> output containing the value OPC in the SETTYPE column, or the value <code>none</code>. The value <code>none</code> removes the OPCSN value from the GTA entry.</p>	
<p>There are other optional parameters that can be used with this entry. Refer to Table 4-48 for these parameters. At least one optional parameter must be specified with the <code>chg-gta</code> command. Unless a default value is shown for a parameter in Table 4-48, the value of any optional parameter that is not specified with the <code>chg-gta</code> command is not changed.</p>	
<p>The <code>egta</code> and <code>split</code> parameters cannot be specified with this entry.</p>	

Table 4-45 (Cont.) GTTSN = CDSSN GTT Set Parameter Combinations

XLAT=DPCNGT, DPCSSN, or DPC	XLAT=NONE
<p>Note: When the <code>xlat</code> parameter value is changed from <code>dpcngt</code>, <code>dpcssn</code>, or <code>dpc</code>, to <code>none</code>, all the optional parameter values that are not specified with the <code>chg-gta</code> command are not changed. However, these changes are made.</p> <ul style="list-style-type: none"> The <code>PC</code> and <code>SSN</code> values are removed from the <code>GTA</code> entry. The <code>CCGT</code> value is removed from the <code>GTA</code> entry and the <code>CCGT</code> field is not shown in the <code>rtrv-gta</code> output. If the original <code>RI</code> value for the <code>GTA</code> entry was <code>SSN</code> and a <code>MAP</code> set was assigned to the <code>GTA</code> entry, the <code>MAPSET</code> value is not changed and the <code>MRNSET=DFLT</code> entry is assigned to the <code>GTA</code> entry. The <code>MRNSET=DFLT</code> entry is shown in the <code>rtrv-gta</code> output. If the original <code>RI</code> value for the <code>GTA</code> entry was <code>GT</code> and an <code>MRN</code> set was assigned to the <code>GTA</code> entry, the <code>MRNSET</code> value is not changed and the <code>MAPSET=DFLT</code> entry is assigned to the <code>GTA</code> entry. The <code>MAPSET=DFLT</code> entry is shown in the <code>rtrv-gta</code> output. 	

Table 4-46 GTTSN = OPCODE GTT Set Parameter Combinations

XLAT=DPCNGT, DPCSSN, or DPC		XLAT=NONE	
Mandatory Parameters			
<p>GTTSN – The <code>GTT</code> set name from the <code>GTTSN</code> column of the <code>rtrv-gttset</code> output containing the value <code>OPCODE</code> in the <code>SETTYPE</code> column and from the <code>GTTSN</code> column of the <code>rtrv-gta</code> output.</p> <p>OPCODE – The <code>OPCODE</code> value assigned to the <code>GTTSN</code> value in the <code>rtrv-gta</code> output. (See Note 4)</p>		<p>GTTSN – The <code>GTT</code> set name from the <code>GTTSN</code> column of the <code>rtrv-gttset</code> output containing the value <code>OPCODE</code> in the <code>SETTYPE</code> column and from the <code>GTTSN</code> column of the <code>rtrv-gta</code> output.</p> <p>OPCODE – The <code>OPCODE</code> value assigned to the <code>GTTSN</code> value in the <code>rtrv-gta</code> output.</p>	
ANSI TCAP Translation	ITU TCAP Translation	ANSI TCAP Translation	ITU TCAP Translation
<p>FAMILY – The <code>FAMILY</code> value assigned to the <code>GTTSN</code> and <code>OPCODE</code> values in the <code>rtrv-gta</code> output.</p> <p>PKGTYPE – The <code>PKGTYPE</code> context name assigned to the <code>GTTSN</code>, <code>FAMILY</code>, and <code>OPCODE</code> values in the <code>rtrv-gta</code> output.</p>	<p>ACN – The application context name assigned to the <code>GTTSN</code> and <code>OPCODE</code> values in the <code>rtrv-gta</code> output.</p> <p>PKGTYPE – The <code>PKGTYPE</code> context name assigned to the <code>GTTSN</code>, <code>ACN</code>, and <code>OPCODE</code> values in the <code>rtrv-gta</code> output.</p>	<p>FAMILY – The <code>FAMILY</code> value assigned to the <code>GTTSN</code> and <code>OPCODE</code> values in the <code>rtrv-gta</code> output.</p> <p>PKGTYPE – The <code>PKGTYPE</code> context name assigned to the <code>GTTSN</code>, <code>FAMILY</code>, and <code>OPCODE</code> values in the <code>rtrv-gta</code> output.</p>	<p>ACN – The application context name assigned to the <code>GTTSN</code> and <code>OPCODE</code> values in the <code>rtrv-gta</code> output.</p> <p>PKGTYPE – The <code>PKGTYPE</code> context name assigned to the <code>GTTSN</code>, <code>ACN</code>, and <code>OPCODE</code> values in the <code>rtrv-gta</code> output.</p>
Optional Parameters			

Table 4-46 (Cont.) GTTSN = OPCODE GTT Set Parameter Combinations

XLAT=DPCNGT, DPCSSN, or DPC	XLAT=NONE
<p>OPTSN – The GTT set name from the GTTSN column of the <code>rtrv-gttset</code> output, or the value <code>none</code>. The value <code>none</code> removes the OPTSN value from the GTA entry. Refer to Table 4-38 for the valid GTT set types that can be specified.</p> <p>The current value of this parameter must be changed to the value <code>none</code> before the parameter value can be changed to another value that is not <code>none</code>. The new value for this parameter cannot be the <code>gttsn</code> value specified with the <code>chg-gta</code> command.</p>	<p>These parameters cannot be specified with the <code>xlat=none</code> parameter.</p> <ul style="list-style-type: none"> • <code>pc/pca/pci/pcn/pcn24</code> • <code>ssn</code> • <code>ri</code> • <code>force=yes</code>
<p>OPCSN – The GTT set name from the GTTSN column of the <code>rtrv-gttset</code> output containing the value <code>OPC</code> in the <code>SETTYPE</code> column. Default value – no OPC GTT set is specified.</p>	
<p>There are other optional parameters that can be used with this entry. Refer to Table 4-48 for these parameters. At least one optional parameter must be specified with the <code>chg-gta</code> command. Unless a default value is shown for a parameter in Table 4-48, the value of any optional parameter that is not specified with the <code>chg-gta</code> command is not changed.</p>	
<p>The <code>egta</code> and <code>split</code> parameters cannot be specified with this entry.</p>	
<p>Note: When the <code>xlat</code> parameter value is changed from <code>dpcngt</code>, <code>dpcssn</code>, or <code>dpc</code>, to <code>none</code>, all the optional parameter values that are not specified with the <code>chg-gta</code> command are not changed. However, these changes are made.</p>	
<ul style="list-style-type: none"> • The <code>PC</code> and <code>SSN</code> values are removed from the GTA entry. • The <code>CCGT</code> value is removed from the GTA entry and the <code>CCGT</code> field is not shown in the <code>rtrv-gta</code> output. • If the original <code>RI</code> value for the GTA entry was <code>SSN</code> and a <code>MAP</code> set was assigned to the GTA entry, the <code>MAPSET</code> value is not changed and the <code>MRNSET=DFLT</code> entry is assigned to the GTA entry. The <code>MRNSET=DFLT</code> entry is shown in the <code>rtrv-gta</code> output. • If the original <code>RI</code> value for the GTA entry was <code>GT</code> and an <code>MRN</code> set was assigned to the GTA entry, the <code>MRNSET</code> value is not changed and the <code>MAPSET=DFLT</code> entry is assigned to the GTA entry. The <code>MAPSET=DFLT</code> entry is shown in the <code>rtrv-gta</code> output. 	

Table 4-47 GTTSN = DPC GTT Set Parameter Combinations

XLAT=DPCNGT, DPCSSN, or DPC	XLAT=NONE
<p>Mandatory Parameters</p>	
<p>GTTSN – The GTT set name from the GTTSN column of the <code>rtrv-gttset</code> output containing the value <code>DPC</code> in the <code>SETTYPE</code> column.</p>	<p>GTTSN – The GTT set name from the GTTSN column of the <code>rtrv-gttset</code> output containing the value <code>DPC</code> in the <code>SETTYPE</code> column.</p>
<p>DPC/DPCA/DPCI/DPCN/DPCN24 (See Notes 1, 2, and 3)</p>	<p>DPC/DPCA/DPCI/DPCN/DPCN24 (See Notes 1, 2, and 3)</p>
<p>Optional Parameters</p>	

Table 4-47 (Cont.) GTTSN = DPC GTT Set Parameter Combinations

XLAT=DPCNGT, DPCSSN, or DPC	XLAT=NONE
<p>OPTSN – The GTT set name from the GTTSN column of the <code>rtrv-gttset</code> output, or the value <code>none</code>. The value <code>none</code> removes the OPTSN value from the GTA entry. Refer to Table 4-38 for the valid GTT set types that can be specified.</p> <p>The current value of this parameter must be changed to the value <code>none</code> before the parameter value can be changed to another value that is not <code>none</code>. The new value for this parameter cannot be the <code>gttsn</code> value specified with the <code>chg-gta</code> command.</p> <p>OPCSN – The GTT set name from the GTTSN column of the <code>rtrv-gttset</code> output containing the value <code>OPC</code> in the <code>SETTYPE</code> column, or the value <code>none</code>. The value <code>none</code> removes the OPCS value from the GTA entry.</p> <p>There are other optional parameters that can be used with this entry. Refer to Table 4-48 for these parameters. The <code>egta</code> and <code>split</code> parameters cannot be specified with this entry.</p> <p>Note: When the <code>xlat</code> parameter value is changed from <code>dpcngt</code>, <code>dpcssn</code>, or <code>dpc</code>, to <code>none</code>, all the optional parameter values that are not specified with the <code>chg-gta</code> command are not changed. However, these changes are made.</p> <ul style="list-style-type: none"> • The <code>PC</code> and <code>SSN</code> values are removed from the GTA entry. • The <code>CCGT</code> value is removed from the GTA entry and the <code>CCGT</code> field is not shown in the <code>rtrv-gta</code> output. • If the original <code>RI</code> value for the GTA entry was <code>SSN</code> and a <code>MAP</code> set was assigned to the GTA entry, the <code>MAPSET</code> value is not changed and the <code>MRNSET=DFLT</code> entry is assigned to the GTA entry. The <code>MRNSET=DFLT</code> entry is shown in the <code>rtrv-gta</code> output. • If the original <code>RI</code> value for the GTA entry was <code>GT</code> and an <code>MRN</code> set was assigned to the GTA entry, the <code>MRNSET</code> value is not changed and the <code>MAPSET=DFLT</code> entry is assigned to the GTA entry. The <code>MAPSET=DFLT</code> entry is shown in the <code>rtrv-gta</code> output. 	<p>These parameters cannot be specified with the <code>xlat=none</code> parameter.</p> <ul style="list-style-type: none"> • <code>pc/pca/pci/pcn/pcn24</code> • <code>ssn</code> • <code>ri</code> • <code>force=yes</code>

Table 4-48 Optional GTA Parameters

XLAT=DPCNGT, DPCSSN, or DPC	XLAT=NONE
PC/PCA/PCI/PCN/PCN24 (See Notes 1, 2, and 3)	MRNSET – MRN set ID from the <code>rtrv-mrn</code> output or <code>none</code> (See Note 4)
SSN – 0 - 255 (See Note 3)	LOOPSET – Loopset name from the <code>rtrv-loopset</code> output (See Note 8)
RI – GT, SSN (See Notes 3, 4, 7)	CGGTMOD – yes, no. Default = no (See Note 9)
MRNSET – MRN set ID from the <code>rtrv-mrn</code> output or <code>none</code> (See Note 4)	MAPSET – MAP set ID from the <code>rtrv-map</code> output or <code>none</code> (See Note 7)
LOOPSET – Loopset name from the <code>rtrv-loopset</code> output (See Note 8)	SPLIT – yes, no. Default = yes (See Note 10)
CGGTMOD – yes, no. Default = no (See Note 9)	TESTMODE – on, off. Default = off.

Table 4-48 (Cont.) Optional GTA Parameters

XLAT=DPCNGT, DPCSSN, or DPC	XLAT=NONE
CCGT – yes, no. (See Note 5)	FALLBACK – sysdflt, yes, no. The Flexible Linkset Optional Based Routing feature must be enabled and turned on to use this parameter.
MAPSET – MAP set ID from the <code>rtrv-map</code> output or <code>none</code> (See Note 8)	CGSELID – 0 - 65534 or <code>none</code> . The Origin-Based SCCP Routing feature must be enabled to use this parameter. (See Note 12)
FORCE – yes, no. Default = no (See Note 6)	CDSELID – 0 - 65534 or <code>none</code> . The Flexible Linkset Optional Based Routing feature must be enabled and turned on to use this parameter. (See Note 12)
SPLIT – yes, no. Default = yes (See Note 10)	CGCNVSN – GTT set name shown in the <code>rtrv-gttset</code> output or <code>none</code> . (See Note 13)
TESTMODE – on, off. Default = off.	ACTSN – The name of the GTT action set name shown in the <code>rtrv-gttaset</code> output or <code>none</code> . (See Note 11)
FALLBACK – sysdflt, yes, no. The Flexible Linkset Optional Based Routing feature must be enabled and turned on to use this parameter.	GTMODID – The name of the GT modification identifier shown in the <code>rtrv-gtmod</code> output or <code>none</code> . The value <code>none</code> removes the GT modification identifier assignment from the GTA entry. If the NGTI value in the global title modification entry is 4, the point code that is assigned to the GTA entry must be an ITU point code.
CGSELID – 0 - 65534 or <code>none</code> . The Origin-Based SCCP Routing feature must be enabled to use this parameter. (See Note 12)	PPMEASREQD – This parameter specifies whether per-path measurements are required for the GTA entry. This parameter has two values. <ul style="list-style-type: none"> • <code>yes</code> - per-path measurements are required for the GTA entry. • <code>no</code> - per-path measurements are not required for the GTA entry.
CDSELID – 0 - 65534 or <code>none</code> . The Flexible Linkset Optional Based Routing feature must be enabled and turned on to use this parameter. (See Note 12)	
CGCNVSN – GTT set name shown in the <code>rtrv-gttset</code> output or <code>none</code> . (See Note 13)	
ACTSN – The name of the GTT action set name shown in the <code>rtrv-gttaset</code> output or <code>none</code> . (See Note 11)	
GTMODID – The name of the GT modification identifier shown in the <code>rtrv-gtmod</code> output or <code>none</code> . The value <code>none</code> removes the GT modification identifier assignment from the GTA entry. If the NGTI value in the global title modification entry is 4, the point code that is assigned to the GTA entry must be an ITU point code.	

Table 4-48 (Cont.) Optional GTA Parameters

XLAT=DPCNGT, DPCSSN, or DPC	XLAT=NONE
PPMEASREQD – This parameter specifies whether per-path measurements are required for the GTA entry. This parameter has two values.	
<ul style="list-style-type: none"> • yes - per-path measurements are required for the GTA entry. • no - per-path measurements are not required for the GTA entry. 	

Table 4-48 (Cont.) Optional GTA Parameters

XLAT=DPCNGT, DPCSSN, or DPC	XLAT=NONE
Notes:	
<ol style="list-style-type: none"> <li data-bbox="370 384 1377 604">1. The <code>pc/pca/pci/pcn/pcn24</code> parameters are used to assign either ANSI, ITU-I, ITU-I spare, 14-bit ITU-N, 14-bit ITU-N spare, or 24-bit ITU-N point codes to the global title address (GTA). <ul style="list-style-type: none"> <li data-bbox="418 474 753 499">• <code>pc/pca</code> = ANSI point code <li data-bbox="418 506 867 531">• <code>pci</code> = ITU-I or ITU-I spare point code <li data-bbox="418 537 1019 562">• <code>pcn</code> = 14-bit ITU-N or 14-bit ITU-N spare point code <li data-bbox="418 569 829 594">• <code>pcn24</code> = 24-bit ITU-N point code. <li data-bbox="370 621 1377 764">2. The domain (ANSI or ITU) of the point code and GTT set must be the same, unless the ANSI/ITU SCCP Conversion feature is enabled. If the ANSI/ITU SCCP Conversion feature is enabled, a GTA may contain an ANSI point code and an ITU GTT set, or an ITU point code and an ANSI GTT set. The CROSS GTT set, a GTT set containing the <code>NETDOM</code> value <code>CROSS</code>, can be specified with either ANSI or ITU point codes. <li data-bbox="370 783 1377 898">3. If the point code is the EAGLE's point code, then the <code>xlat</code> parameter value must be <code>dpcssn</code> and the <code>ri</code> parameter value must be <code>ssn</code>. The <code>ssn</code> parameter can be specified only if the <code>xlat</code> parameter is <code>dpcssn</code>. If the <code>xlat</code> parameter value is being changed to <code>dpcssn</code>, the <code>ssn</code> parameter must be specified. <li data-bbox="370 917 1377 1033">4. The <code>mrnset</code> parameter can be specified only, and must be specified, if the Flexible GTT Load Sharing feature is enabled. The <code>mrnset</code> parameter can be specified only if the <code>ri</code> parameter value is <code>sgt</code>. Specifying the <code>mrnset=none</code> parameter removes the MRN set ID assignment from the GTA entry. <li data-bbox="370 1052 1377 1108">5. If the point code is the EAGLE's point code, then the value of the <code>csgt</code> parameter must be set to <code>no</code>. <li data-bbox="370 1127 1377 1222">6. If the <code>pc/pca/pci/pcn/pcn24</code> parameter value is not shown in the <code>rtrv-map</code> output, and the resulting <code>xlat</code> parameter value is <code>dpc</code>, and the resulting <code>ri</code> parameter value is <code>ssn</code>, the <code>force=yes</code> parameter must be specified with the <code>chg-gta</code> command. <li data-bbox="370 1241 1377 1356">7. The <code>mapset</code> parameter can be specified only, and must be specified, if the Flexible GTT Load Sharing feature is enabled. The <code>mapset</code> parameter can be specified only if the <code>ri</code> parameter value is <code>ssn</code>. Specifying the <code>mapset=none</code> parameter removes the MAP set ID assignment from the GTA entry. <li data-bbox="370 1375 1377 1432">8. The <code>loopset</code> parameter can be specified only if the SCCP Loop Detection feature is enabled. <li data-bbox="370 1451 1377 1507">9. The <code>csgtmod</code> parameter can be specified only if the AMGTT or AMGTT CgPA Upgrade feature is enabled. <li data-bbox="370 1526 1377 1642">10. The range of global title addresses assigned to a global title translation can be extended, reduced, or split to create a new range of global title addresses. See the <code>split</code> parameter description section in this procedure for information on changing the range of global title addresses. <li data-bbox="370 1661 1377 1755">11. The <code>actsn</code> parameter can be specified only if the GTT Action - DISCARD, GTT Action - DUPLICATE, GTT Action - FORWARD feature is enabled. The value <code>none</code> removes the GTT action set name assignment from the GTA entry. <li data-bbox="370 1774 1377 1831">12. The current value of this parameter must be changed to the value <code>none</code> before the parameter value can be changed to another value that is not <code>none</code>. <li data-bbox="370 1850 1377 1898">13. The ANSI/ITU SCCP Conversion feature must be enabled, and the Flexible Linkset Optional Based Routing feature must be enabled and turned on to use this parameter. 	

Table 4-48 (Cont.) Optional GTA Parameters

XLAT=DPCNGT, DPCSSN, or DPC	XLAT=NONE
<p>Specifying the <code>cgcnvsn=none</code> parameter removes the CGCNVSN value from the GTA entry. The current value of this parameter must be changed to the value <code>none</code> before the parameter value can be changed to another value that is not <code>none</code>. The new value for this parameter cannot be the <code>gttsn</code> value specified with the <code>chg-gta</code> command, but must be a GTT set whose set type is either CDGTA or CGGTA..</p>	

1. Display the GTT sets in the database using the `rtrv-gttset` command.

This is an example of the possible output.

```
rlghncxa03w 09-07-07 00:29:31 GMT EAGLE5 41.1.0
```

GTTSN	NETDOM	SETTYPE	NDGT
abcd1234	itu	CGGTA	12
gttset3	ansi	CGGTA	10
gttset6	ansi	OPC	-
gttset7	ansi	CGPC	-
gttset12	ansi	OPC	-
imsi	itu	CDGTA	15
lidb	ansi	CDGTA	10
t800	ansi	CDGTA	10
s1000	itu	CDGTA	15
s2000	itu	CGPC	-

GTT-SET table is (10 of 2000) 1% full.

2. Display the global title address (GTA) information for the GTT set that contains the global title address entry that is being changed. Use the `rtrv-gta` command with the `gttsn` parameter value shown in the output of 1. If the `num` parameter is specified with the `rtrv-gta` command, and the value of the `num` parameter is greater than 1000, the `force=yes` parameter must be specified with the `rtrv-gta` command. For this example, enter this command.

```
rtrv-gta:gttsn=lidb
```

This is an example of the possible output.

```
rlghncxa03w 10-07-07 00:27:31 GMT EAGLE5 42.0.0
```

GTTSN	NETDOM	SETTYPE	NDGT
lidb	ansi	CDGTA	10

GTA TABLE IS 1 % FULL (17 of 269999)

START GTA	END GTA	XLAT	RI	PC
9195554321	9195554321	DPCNGT	GT	001-255-253
SSN=--- CCGT=no CGGTMOD=NO				
GTMODID=modid2 TESTMODE=off				
LOOPSET = none FALLBACK=sysdflt				
OPTSN=----- CGSELID=----- OPCS=-----				
ACTSN=----- PPMEASREQD= NO				

Command Retrieved 1 Entries

If any of these conditions are present, this step has been completed.

- The OPTSN, OPCS, or CGCNVSN fields are not shown in the `rtrv-gta` output.
- The OPTSN, OPCS, or CGCNVSN fields are shown in the `rtrv-gta` output and the OPTSN, OPCS, or CGCNVSN values are not being changed.
- The OPTSN, OPCS, or CGCNVSN fields are shown in the `rtrv-gta` output, the OPTSN, OPCS, or CGCNVSN values are being changed, and the desired GTT set is shown in the `rtrv-gttset` output in [1](#).

If the OPTSN, OPCS, or CGCNVSN fields are shown in the `rtrv-gta` output, the OPTSN, OPCS, or CGCNVSN values are being changed, and the desired GTT set is not shown in the `rtrv-gttset` output in [1](#), perform [Adding a GTT Set](#) to add the new GTT set.

After this step has been completed, continue the procedure by performing one of these steps.

- If the GTA entry does contains a range of global title addresses, CgPA subsystem numbers, or CdPA subsystem numbers, and this range will be split, continue the procedure with [3](#).
 - If the GTA entry does contains a range of global title addresses, CgPA subsystem numbers, or CdPA subsystem numbers, and this range will not be split, or if the GTA entry does not contain a range of global title addresses, CgPA subsystem numbers, or CdPA subsystem numbers, continue the procedure with [5](#).
- 3.** Splitting a range of global title addresses, CgPA subsystem numbers, or CdPA subsystem numbers creates a new GTA entry.

If splitting the global title addresses, CgPA subsystem numbers, or CdPA subsystem numbers will increase the number of global title translations in the database beyond the maximum number of global title translations shown in the `rtrv-gta` output in [2](#), and the maximum number of global title translations is either 269,999 or 400,000, the maximum number of global title translations must be increased. Perform the [Enabling the XGTT Table Expansion Feature](#) procedure to increase the maximum number of global title translations. If the maximum number of global title translations is 1,000,000, the maximum number of global title translations cannot be increased. The range of global title addresses, CgPA subsystem numbers, or CdPA subsystem numbers cannot be split. This new entry cannot be created if the database contains the maximum number of GTA entries.

Continue the procedure by performing one of these steps.

- If the GTA entry does not contain a range of global title addresses, or the number of global title translations in the database will not be increased beyond the maximum number of global title translations shown in the `rtrv-gta` output in [2](#), continue the procedure with [5](#).
 - If the GTA entry contains a range of global title addresses that will be split and the number of global title translations in the database will not be increased beyond the maximum number of global title translations shown in the `rtrv-gta` output in [2](#), continue the procedure with [4](#).
- 4.** Display the GTT path entries by entering the `rtrv-gttapath` command with these parameters.

cdgttsn - the GTTSN value shown in the `rtrv-gta` output in 2.
cdgta - the START GTA value shown in the `rtrv-gta` output in 2.

For this example, enter this command.

```
rtrv-gttapath:cdgttsn=libb:cdgta=9195554321
```

This is an example of the possible output.

```
rlghncxa03w 10-07-25 09:43:31 GMT EAGLE5 42.0.0

GTPN   OPGTTSN           CGGTTSN           CDGTTSN
-----
path1  -----           -----           libb
      CDGTA = 9195554321           ECDGTA = 9195554321
```

GTT-PATH table is (5 of 10000) 1% full.

The range of global title addresses cannot be split if entries containing the GTTSN and the GTA values shown in the `rtrv-gttapath` output. If entries are displayed in the `rtrv-gttapath` output, perform the [Removing a GTT Action Path Entry](#) procedure to remove the entries shown in the `rtrv-gttapath` output.

Continue the procedure with 5 if no entries are shown in this step; error message E3451 is displayed; if the entries in the `rtrv-gttapath` output will not be removed; or the [Removing a GTT Action Path Entry](#) procedure has been performed.

5. Display the features that are enabled by entering the `rtrv-ctrl-feat` command.

The following is an example of the possible output.

```
rlghncxa03w 09-05-28 21:15:37 GMT EAGLE5 41.0.0
The following features have been permanently enabled:
```

Feature Name	Partnum	Status	Quantity
XGTT Table Expansion	893006101	on	400000
SCCP Loop Detection	893016501	on	----
SCCP Conversion	893012001	off	----
HC-MIM SLK Capacity	893012707	on	64
Origin Based SCCP Routing	893014301	on	----
TCAP Opcode Based Routing	893027801	on	----
Flex Lset Optnl Based Rtg	893027701	on	----
VGTT with 16 GTT lengths	893024801	on	----
TOBR Opcode Quantity	893027907	on	1000000

The following features have been temporarily enabled:

Feature Name	Partnum	Status	Quantity	Trial Period
Left				
Zero entries found.				

The following features have expired temporary keys:

```
Feature Name          Partnum
Zero entries found.
```

6. Some parameters of the `chg-gta` command can be specified only when certain features are enabled, and turned on if necessary. [Table 4-49](#) shows the feature requirements for these parameters. Some

Table 4-49 Feature Requirements for CHG-GTA Parameters

Required Feature	Parameters or Values
Origin-Based SCCP Routing Enabled	GTTSN - specifying CGGTA, CGPC, CGSSN, or OPC GTT sets OPTSN - specifying CGGTA, CGPC, or CGSSN GTT sets OPCSN CGPC CGSSN ECGSSN OPC CGSELID
Flexible GTT Load Sharing Enabled	MAPSET MRNSET
Flexible Linkset Optional Based Routing Enabled and Turned On	GTTSN - specifying CDSSN or DPC GTT sets OPTSN - specifying CDSSN or DPC GTT sets FALLBACK CDSSN ECDSSN CDSELID DPC
ANSI/ITU SCCP Conversion Enabled and Flexible Linkset Optional Based Routing Enabled and Turned On	CGCNVSN
TCAP Opcode Based Routing Enabled and Turned On	GTTSN - specifying OPCODE GTT sets OPTSN - specifying OPCODE GTT sets
TOBR Quantity Enabled	ACN FAMILY OPCODE PKGTYPE
SCCP Loop Detection Enabled	LOOPSET
Advanced GT Modification or AMGTT CgPA Upgrade Enabled	CGGTMOD
ANSI/ITU SCCP Conversion Enabled	The domain (ANSI or ITU) of the point code and the GTT set that will be assigned to the GTA entry will be different.
Hex Digit Support for GTT Enabled	Hexadecimal digits will be specified for the <code>gta</code> or <code>egta</code> parameter values.

Table 4-49 (Cont.) Feature Requirements for CHG-GTA Parameters

Required Feature	Parameters or Values
GTT Action - DISCARD, GTT Action - DUPLICATE, GTT Action - FORWARD Enabled	ACTSN
<p>To enable, and turn on if necessary, any of these features, perform these procedures.</p> <ul style="list-style-type: none"> • Origin-Based SCCP Routing - Activating the Origin-Based SCCP Routing Feature • Flexible GTT Load Sharing - Activating the Flexible GTT Load Sharing Feature. After the Flexible GTT Load Sharing feature has been enabled, perform one of these procedures. <ul style="list-style-type: none"> – If the <code>mrnset</code> and <code>ri=gt</code> parameters will be specified for the GTA entry, perform Provisioning MRN Entries to add the required MRNSET. – If the <code>mapset</code> and <code>ri=ssn</code> parameters will be specified for the GTA entry, perform one of these procedures to add the required MAPSET. <ul style="list-style-type: none"> * Provisioning a Solitary Mated Application * Provisioning a Dominant Mated Application * Provisioning a Load Shared Mated Application * Provisioning a Combined Dominant/Load Shared Mated Application • Flexible Linkset Optional Based Routing - Activating the Flexible Linkset Optional Based Routing Feature • TCAP Opcode Based Routing - Activating the TCAP Opcode Based Routing Feature • TOBR Opcode Quantity - Enabling a TOBR Opcode Quantity • SCCP Loop Detection - Activating the SCCP Loop Detection Feature. After the SCCP Loop Detection feature is enabled, perform the Adding a Loopset procedure to add the required loopset. • Advanced GT Modification or AMGTT CgPA Upgrade - Activating the Advanced GT Modification Feature. • ANSI/ITU SCCP Conversion - Activating the ANSI/ITU SCCP Conversion Feature • Hex Digit Support for GTT Enabled - Activating the Hex Digit Support for GTT Feature • GTT Action - DISCARD, GTT Action - DUPLICATE, GTT Action - FORWARD - Activating the GTT Actions Features. After the required GTT Actions feature is enabled, perform the Adding a GTT Action Set procedure to add the required GTT action set. <p>If the required feature is enabled, and turned on if required, shown in the <code>rtrv-ctrl-feat</code> output in 5, the procedure for that feature does not need to be performed.</p>	

7. To use either the `mrnset` parameter (if the routing indicator value for the global title translation is GT) or `mapset` parameter (if the routing indicator value for the global title translation is SSN), the Flexible GTT Load Sharing feature must be enabled. See [6](#). The `mrnset` and `mapset` parameters can be specified if the `xlat=none` parameter is specified for the GTA entry.

If the Flexible GTT Load Sharing feature is enabled, the GTA entry must contain either an MRNSET or MAPSET value, depending on the routing indicator value for the global title translation being changed.

If the routing indicator for the GTA entry that is being changed will be GT when this procedure is completed, continue the procedure by performing one of these steps.

- If the Flexible GTT Load Sharing feature is not enabled and the point code value will not be changed, continue the procedure with [19](#).
- If the Flexible GTT Load Sharing feature is not enabled, and the point code value will be changed, continue the procedure with [9](#).

- If the Flexible GTT Load Sharing feature is enabled and the point code value will be changed, whether or not the MRNSET value will be changed, continue the procedure with 11.
- If the Flexible GTT Load Sharing feature is enabled and the point code and MRNSET values will not be changed, continue the procedure with 19.

If the routing indicator for the GTA entry that is being changed will be SSN when this procedure is completed, continue the procedure by performing one of these steps.

- If the XLAT parameter value will be DPC when this procedure is completed, continue the procedure by performing one of these steps.
 - If the point code value will not be changed and the Flexible GTT Load Sharing feature is not enabled, continue the procedure with 19.
 - If the point code value will not be changed; the Flexible GTT Load Sharing feature is enabled and the MAPSET value will not be changed, continue the procedure with 19.
 - If the point code value will not be changed; the Flexible GTT Load Sharing feature is enabled and the MAPSET value will be changed, continue the procedure with 13.
 - If the point code value will be changed, continue the procedure with 13.
- If the XLAT parameter value will be DPCSSN when this procedure is completed, continue the procedure by performing one of these steps.
 - If the point code, SSN, and MAPSET value (if the Flexible GTT Load Sharing feature is enabled) will not be changed, continue the procedure with 19.
 - If the point code will be changed, continue the procedure by performing one of these steps.
 - * If the new point code value will not be the EAGLE's point code, continue the procedure with 13.
 - * If the new point code value will be the EAGLE's point code, continue the procedure with 12.
 - If only the SSN value will be changed, continue the procedure with 12.
 - If the Flexible GTT Load Sharing feature is enabled and only the MAPSET value will be changed, continue the procedure with 12.

If the `xlat=none` parameter will be specified and the Flexible GTT Load Sharing feature is not enabled, continue the procedure with 18.

If the `xlat=none` parameter will be specified and the Flexible GTT Load Sharing feature is enabled, continue the procedure by performing one of these steps. Both the `mrnset` and `mapset` parameters can be specified for the GTA entry.

- If the `mrnset` parameter will be specified, continue the procedure with 8.
 - If the `mapset` parameter will be specified, continue the procedure with 13.
8. The point code and MRN set ID specified with the `chg-gta` command must be shown in the `rtv-mrn` command output. The point code must be assigned to the MRN set that will be specified with the `chg-gta` command.

Enter the `rtrv-mrn` command to verify that the required MRN set is configured in the database, and that the required point code is assigned to the MRN set. The following is an example of the possible output.

```
rlghncxa03w 09-05-28 21:15:37 GMT EAGLE5 41.0.0
```

```
MRNSET  PC          RC
DFLT    001-001-001    10
        001-001-002    20
        001-001-003    30
        001-254-255    40
```

```
MRNSET  PC          RC
110     001-001-001    10
        001-001-005    20
        001-001-006    30
        001-001-003    40
        001-001-008    50
```

```
MRNSET  PC          RC
111     001-001-001    30
        001-001-005    30
        001-001-006    30
        001-001-003    30
        001-001-008    30
```

```
MRNSET  PC          RC
112     001-003-001    10
        001-003-002    10
        001-003-003    30
        001-003-004    30
        001-003-006    60
        001-003-007    60
        001-003-008    80
        001-003-009    80
```

```
MRNSET  PCN          RC
113     s-1-1-1-0123-aa    1
        s-1-1-1-0235-aa    2
        s-1-1-1-0235-aa    3
```

 **Note:**

If the Weighted GTT Load Sharing feature is enabled, the `WT`, `%WT`, and `THR` columns are shown in the `rtrv-mrn` output.

If the required MRN set is not shown in the `rtrv-mrn` output, or if the required point code is not assigned to the required MRN set, provision the required MRN set by performing the [Provisioning MRN Entries](#) procedure. After provisioning the required MRN set, continue the procedure with [18](#).

If the required MRN set is shown in the `rtrv-mrn` output, or if the required point code is assigned to the required MRN set, continue the procedure with [18](#).

9. Display the destination point codes in the database by entering the `rtrv-dstn` command. This is an example of the possible output.

```
rlghncxa03w 10-12-10 11:43:04 GMT EAGLE5 43.0.0
Extended Processing Time may be Required
```

DPCA	CLLI	BEI	ELEI	ALIASI
ALIASN/N24	DMN			
001-207-000	-----	no	---	-----
-----	SS7			
001-001-001	-----	no	---	-----
-----	SS7			
001-001-002	-----	no	---	-----
-----	SS7			
001-005-000	-----	no	---	-----
-----	SS7			
001-007-000	-----	no	---	-----
-----	SS7			
008-012-003	-----	no	---	-----
-----	SS7			
003-002-004	-----	no	---	-----
-----	SS7			
009-002-003	-----	no	---	-----
-----	SS7			
010-020-005	-----	no	---	-----
-----	SS7			

DPCI	CLLI	BEI	ELEI	ALIASA
ALIASN/N24	DMN			
1-207-0	-----	no	---	-----
-----	SS7			
0-015-0	-----	no	---	-----
-----	SS7			
0-017-0	-----	no	---	-----
-----	SS7			
1-011-1	-----	no	---	-----
-----	SS7			
1-011-2	-----	no	---	-----
-----	SS7			

```
Destination table is (14 of 2000) 1% full
Alias table is (0 of 12000) 0% full
PPC table is (1 of 20) 5% full
```

If the required point code is not shown in the `rtrv-dstn` output, perform the "Adding a Destination Point Code" procedure in *Database Administration - SS7 User's Guide* to add the required point code. A proxy point code cannot be assigned to the point code.

After the new point code has been added, perform one of the Adding a Route procedures in *Database Administration - SS7 User's Guide* and add the required route to the database. After the route has been added, continue the procedure with [18](#).

If the required point code is shown in the `rtrv-dstn` output, continue the procedure with [10](#).

10. Display the point code that will be assigned to the mated application by using the `rtrv-dstn` command and specifying the point code. For this example, enter this command.

```
rtrv-dstn:dPCA=010-020-005
```

This is an example of the possible output.

```
rlghncxa03w 10-12-10 11:43:04 GMT EAGLE5 43.0.0
```

DPCA	CLLI	BEI	ELEI	ALIASI					
ALIASN/N24	DMN								
010-020-005	-----	no	---	-----					
-----	SS7								
PPCA	NCAI	PRX	RCAUSE	NPRST	SPLITIAM	HMSMSC	HMSCP		
SCCPMSGCNV									
009-002-003	----	no	none	off	none	no	no	none	

```
Destination table is (14 of 2000) 1% full
Alias table is (0 of 12000) 0% full
PPC table is (1 of 20) 5% full
```

A proxy point code (a point code value is shown in the `PPC` column) cannot be assigned to the point code. If a proxy point code is shown in this step, choose another point code from the `rtrv-dstn` output in the previous step and repeat this step.

After the new point code has been added, perform one of the Adding a Route procedures in *Database Administration - SS7 User's Guide* and add the required route to the database. After the route has been added, continue the procedure with [18](#).

If the point code displayed in this step does not contain a proxy point code, continue the procedure with [11](#).

11. The point code specified with the `chg-gta` command must be the DPC of a route, unless the point code is the EAGLE's point code.

Enter the `rtrv-rte` command with the `dpc` parameter specifying the point code to be used with the `chg-gta` command to verify whether or not the point code is the DPC of a route. For this example, enter this command.

```
rtrv-rte:dPCA=001-255-252
```

This is an example of the possible output.

```
rlghncxa03w 09-05-07 11:43:04 GMT EAGLE5 41.0.0
```

DPCA	ALIASI	ALIASN/N24	LSN	RC	APCA
001-255-252	-----	-----	1s07	10	
001-255-252			1s08	30	
025-025-150			1sa5	50	

066-030-100

RTX:No CLLI=1s07clli

If the point code is not shown in the `rtrv-rte` output, perform one of the Adding a Route procedures in *Database Administration - SS7 User's Guide* and add the required route to the database.

If the point code is shown in the `rtrv-rte` output, and a new route was added, continue the procedure with 18.

12. If the `ri=ssn` and `xlat=dpcssn` parameters are specified with the `chg-gta` command, and you wish to use the EAGLE's point code for the value of the `pc` parameter of the `chg-gta` command, the point code value must be in the EAGLE's self ID table. Display the EAGLE self-identification, using the `rtrv-sid` command. This is an example of the possible output.

```
rlghncxa03w 09-05-10 11:43:04 GMT EAGLE5 41.0.0
  PCA          PCI          PCN
CLLI          PCTYPE
  010-020-030  1-023-1      12-0-14-1
rlghncxa03w   OTHER
              s-1-023-1  s-12-0-14-1

CPCA
002-002-002   002-002-003   002-002-004   002-002-005
002-002-006   002-002-007   002-002-008   002-002-009
004-002-001   004-003-003   050-060-070

CPCI
1-001-1       1-001-2       1-001-3       1-001-4
1-002-1       1-002-2       1-002-3       1-002-4
2-001-1       7-222-7

CPCN
2-0-10-3      2-0-11-0      2-0-11-2      2-0-12-1
2-2-3-3      2-2-4-0       10-14-10-1
```

Continue the procedure by performing one of these steps.

- If the point code value will be changed to the EAGLE's point code, continue the procedure with 13.
 - If the SSN value will be changed and the current point code value is the EAGLE's point code, continue the procedure with 13.
 - If the MAPSET value will be changed, continue the procedure with 13.
13. Enter the `rtrv-map` command with the `pc` parameter specifying the required point code to verify that the required data is in the mated application table.

 **Note:**

If the Flexible GTT Load Sharing feature is enabled, a MAP set ID must be specified for the final global title translation. The point code and SSN specified for the final global title translation being changed in this procedure must be assigned to the MAP set ID that will be assigned to the final global title translation. Perform this step to verify that the required MAP set is configured in the database.

If the point code value of the GTA entry is being changed, specify the new point code value of the GTA entry.

If the point code value of the GTA entry is not being changed, specify the current point code value of the GTA entry.

If the point code value of the GTA entry will be the EAGLE's point code, specify the EAGLE's point code, shown in 12. The MAP entry that contains the EAGLE's point code must be in the default MAP set.

If the XLAT value of the GTA entry will be DPCSSN when this procedure is completed, and the SSN or MAPSET value will be changed, specify the new SSN value, if the SSN value will be changed, or the current SSN value, if the SSN value will not be changed, in this step.

For this example enter this command.

```
rtrv-map:pca=001-255-252
```

```
rlghncxa03w 09-07-25 09:42:31 GMT EAGLE5 41.1.0
```

PCA	Mate PCA	SSN	RC	MULT	SRM	MRC	GRP	NAME	SSO
MAPSET ID=DFLT									
001-255-252		55	5	DOM	YES	YES	-----		OFF
	001-001-002	15	15	DOM	YES	YES	-----		ON
	001-001-003	25	20	DOM	YES	YES	-----		ON
	001-001-002	40	35	DOM	YES	YES	-----		OFF
MAPSET ID=1									
001-255-252		254	5	DOM	YES	YES	-----		OFF
	001-001-002	10	15	DOM	YES	YES	-----		ON
	001-001-003	20	20	DOM	YES	YES	-----		ON
	001-001-002	40	35	DOM	YES	YES	-----		OFF
MAPSET ID=2									
001-255-252		5	10	SOL	*Y	*Y	-----		OFF
MAP TABLE IS (12 of 36000) 1 % FULL									

 **Note:**

If the Weighted GTT Load Sharing feature is enabled, the WT, %WT, and THR columns are shown in the rtrv-map output.

If the parameter values for the ri and xlat parameters will be ri=ssn and xlat=dpc when this procedure is completed, the point code value must be in the

mated application table. If the point code is not in the mated application table when the `chg-gta` command is executed, the `force=yes` parameter must be specified with the `chg-gta` command. If the `force=yes` parameter will be used with the `chg-gta` command, continue the procedure with [15](#).

If the parameter values for the `ri` and `xlat` parameters will be `ri=ssn` and `xlat=dpcssn`, and the point code and subsystem number values will be the EAGLE's true point code and the EAGLE's subsystem number when this procedure is completed, the EAGLE's true point code and the EAGLE's subsystem number must be in the mated application table.

If the required point code, subsystem number, or MAP set ID is not shown in the `rtrv-map` output, perform one of these procedures to add the required information to the mated application table.

- [Provisioning a Solitary Mated Application](#)
- [Provisioning a Dominant Mated Application](#)
- [Provisioning a Load Shared Mated Application](#)
- [Provisioning a Combined Dominant/Load Shared Mated Application](#)

If the required MAP entry is shown in this step, or a new MAP entry was added in this step, continue the procedure with [18](#).

If the point code value is being changed in this procedure to the EAGLE's point code, continue the procedure with [12](#).

14. Enter the `rtrv-ss-appl` command to verify that either the LNP, EIR, V-Flex, ATINPQ, AIQ, or INP subsystem number (depending on which feature is on) is in the subsystem application table.

This is an example of the possible output.

```
rlghncxa03w 08-09-28 14:42:38 GMT EAGLE5 41.0.0
APPL      SSN      STAT
LNP      254      ONLINE
```

```
SS-APPL table is 20% FULL (1 of 5)
```

If no subsystem number is shown in the `rtrv-ss-appl` output, or if the `rtrv-ss-appl` command is rejected, go to one of these user's guides, depending on the type of subsystem you wish to use, to enable and turn on the feature as necessary, and add the subsystem to the subsystem application table.

- EIR subsystem – go to *EIR User's Guide*.
- INP subsystem – go to *INP/AINPQ User's Guide*.
- LNP subsystem – go to *ELAP Administration and LNP Feature Activation Guide*.
- V-Flex subsystem – go to *V-Flex User's Guide*.
- ATINPQ subsystem – go to *ATINP*.
- AIQ subsystem – go to *Analyzed Information Features User's Guide*.

If the subsystem number is shown in the `rtrv-ss-appl` output, or the subsystem number has been added in this step, continue the procedure with [18](#).

15. Display the destination point codes in the database by entering the `rtrv-dstn` command. This is an example of the possible output.

```
rlghncxa03w 10-12-10 11:43:04 GMT EAGLE5 43.0.0
Extended Processing Time may be Required
```

DPCA	CLLI	BEI	ELEI	ALIASI
ALIASN/N24	DMN			
001-207-000	-----	no	---	-----
-----	SS7			
001-001-001	-----	no	---	-----
-----	SS7			
001-001-002	-----	no	---	-----
-----	SS7			
001-005-000	-----	no	---	-----
-----	SS7			
001-007-000	-----	no	---	-----
-----	SS7			
008-012-003	-----	no	---	-----
-----	SS7			
003-002-004	-----	no	---	-----
-----	SS7			
009-002-003	-----	no	---	-----
-----	SS7			
010-020-005	-----	no	---	-----
-----	SS7			

DPCI	CLLI	BEI	ELEI	ALIASA
ALIASN/N24	DMN			
1-207-0	-----	no	---	-----
-----	SS7			
0-015-0	-----	no	---	-----
-----	SS7			
0-017-0	-----	no	---	-----
-----	SS7			
1-011-1	-----	no	---	-----
-----	SS7			
1-011-2	-----	no	---	-----
-----	SS7			

```
Destination table is (14 of 2000) 1% full
Alias table is (0 of 12000) 0% full
PPC table is (1 of 20) 5% full
```

If the required point code is not shown in the `rtrv-dstn` output, perform the "Adding a Destination Point Code" procedure in *Database Administration - SS7 User's Guide* to add the required point code. A proxy point code cannot be assigned to the point code.

After the new point code has been added, perform one of the Adding a Route procedures in *Database Administration - SS7 User's Guide* to add the required route to the database. After the route has been added, continue the procedure with 18.

If the required point code is shown in the `rtrv-dstn` output, continue the procedure with [16](#).

16. Display the point code that will be assigned to the mated application by using the `rtrv-dstn` command and specifying the point code. For this example, enter this command.

```
rtrv-dstn:dPCA=010-020-005
```

This is an example of the possible output.

```
rlghncxa03w 10-12-10 11:43:04 GMT EAGLE5 43.0.0
```

DPCA	CLLI	BEI	ELEI	ALIASI					
ALIASN/N24	DMN								
010-020-005	-----	no	---	-----					
-----	SS7								
PPCA	NCAI	PRX	RCAUSE	NPRST	SPLITIAM	HMSMSC	HMSCP		
SCCPMSGCNV									
009-002-003	----	no	none	off	none	no	no	none	

Destination table is (14 of 2000) 1% full

Alias table is (0 of 12000) 0% full

PPC table is (1 of 20) 5% full

A proxy point code (a point code value is shown in the `PPC` column) cannot be assigned to the point code. If a proxy point code is shown in this step, choose another point code from the `rtrv-dstn` output in the previous step and repeat this step.

After the new point code has been added, perform one of the Adding a Route procedures in *Database Administration - SS7 User's Guide* and add the required route to the database. After the route has been added, continue the procedure with [18](#).

If the point code displayed in this step does not contain a proxy point code, continue the procedure with [17](#).

17. The point code specified with the `chg-gta` command must be the DPC of a route, unless the point code is the EAGLE's point code.

Enter the `rtrv-rte` command with the `dpc` parameter specifying the point code to be used with the `chg-gta` command to verify whether or not the point code is the DPC of a route. For this example, enter this command.

```
rtrv-rte:dPCA=001-255-252
```

This is an example of the possible output.

```
rlghncxa03w 09-05-07 11:43:04 GMT EAGLE5 41.0.0
```

DPCA	ALIASI	ALIASN/N24	LSN	RC	APCA
001-255-252	-----	-----	1s07	10	
001-255-252			1s08	30	
025-025-150			1sa5	50	

066-030-100

RTX:No CLLI=1s07c11i

If the point code is not shown in the `rtrv-rte` output, perform one of the Adding a Route procedures in *Database Administration - SS7 User's Guide* and add the required route to the database.

If the point code is shown in the `rtrv-rte` output, and a new route was added, continue the procedure with [18](#).

18. Continue the procedure by performing one or more of these steps depending on the parameters that will be specified with the `ent-gta` command.

If the `loopset` parameter will be specified for the GTA entry, and the desired LOOPSET value is not shown in the `rtrv-gta` output, continue the procedure with [19](#).

If the `gtmodid` parameter will be specified for the GTA entry, and the desired GTMODID value is not shown in the `rtrv-gta` output, continue the procedure with [20](#).

If the `actsn` parameter will be specified for the GTA entry, and the desired ACTSN value is not shown in the `rtrv-gta` output, continue the procedure with [21](#).

If the `loopset`, `gtmodid`, and `actsn` parameters will not be specified for the GTA entry, continue the procedure with [22](#).

19. Display all the loopsets in the database by entering this command. `rtrv-loopset:num=1000:force=yes`

This is an example of the possible output.

LoopSet	Mode	Point Codes	
=====			
==			
cary2	notify	005-015-005	007-007-007 (ANSI)
		033-004-003	033-007-003
		005-027-005	007-004-007
cary4	notify	005-012-005	007-026-007 (ANSI)
		003-049-003	033-002-003
		005-008-055	007-014-007
apex3	discard	005-017-008	007-017-009 (ANSI)
		033-005-043	005-014-005
		005-017-005	007-014-007
		033-002-043	005-038-005
		007-009-027	033-003-043
		005-012-005	007-002-027
apex4	discard	005-007-008	027-007-009 (ANSI)
		033-005-003	005-004-055
		027-001-007	033-008-003
		033-007-003	005-003-055
		027-008-007	
ral5	notify	005-005-005	007-007-007 (ANSI)
		003-004-003	003-001-003

		005-007-005	007-004-007	
		003-002-003	005-008-005	
		007-009-007	003-003-003	
		005-002-005	007-002-007	
ral6	notify	005-007-008	007-007-009	(ANSI)
		003-005-003	003-007-003	
		005-007-005		
dunn1	discard	005-002-055	007-051-007	(ANSI)
		003-008-033		
rtp9	discard	005-002-005	007-001-007	(ANSI)
		003-008-003	003-007-003	
		005-003-005	007-008-007	
		005-004-005		
rtp5	discard	005-007-008	007-007-009	(ANSI)
		003-005-003		
rtp1	discard	005-005-005	007-007-007	(ANSI)
		003-004-003	003-007-003	
		005-007-005	007-004-007	
		005-004-005		
rtp2	notify	005-007-008	007-007-009	(ANSI)
		003-005-003		

```
rlghncxa03w 07-03-07 08:50:15 GMT Rel 35.6.0
LOOPSET table is (11 of 1000) 1% full
RTRV-LOOPSET: MASP A - COMPLTD
```

 **Note:**

If the `rtrv-loopset` command is entered with no other parameters specified, a maximum of 50 entries are displayed. To display more than 50 entries, the `force=yes` parameter must be specified with the `rtrv-loopset` command and the `num` parameter value must be greater than 50. Since there can be a maximum of 1000 loopsets in the database, to display all the loopsets in the database, the `force=yes` and `num=1000` parameters must be specified with the `rtrv-loopset` command.

If the required loopset is not shown in the `rtrv-loopset` output, perform [Adding a Loopset](#) to add the required loopset.

if the required loopset is shown in the `rtrv-loopset` output, or if a new loopset was added, continue the procedure by performing one of these steps.

- If the `gtmodid` parameter will be specified for the GTA entry, and the desired GTMODID value is not shown in the `rtrv-gta` output, continue the procedure with [20](#).

- If the `actsn` parameter will be specified for the GTA entry, and the desired ACTSN value is not shown in the `rtrv-gta` output, continue the procedure with [21](#).
 - If the `gtmodid` and `actsn` parameters will not be specified for the GTA entry, continue the procedure with [22](#).
- 20.** Display the GT modification information in the database using the `rtrv-gtmod` command.

This is an example of the possible output.

```
rlghncxa03w 10-07-07 00:29:31 GMT EAGLE5 42.0.0
```

GTMODID	NTT	NGTI	GT0FILL	NNP	NNAI	NPDD	NSDD	PRECD	CGPASSN
modid2	--	2	ON	--	--	--	--	PFX	--
modid5	--	2	OFF	--	--	--	--	PFX	--
modid6	--	4	ON	4	5	3	3	SFX	--
modid10	--	--	OFF	5	5	--	--	PFX	--
modid11	--	--	OFF	5	5	--	--	PFX	--

GTMOD table is (5 of 100000) 1% full.

If the desired GT modification entry is not displayed, perform the [Adding Global Title Modification Information](#) procedure to add the desired GT modification entry to the database.

If the desired GT modification entry is displayed or the [Adding Global Title Modification Information](#) procedure was performed, continue the procedure by performing one of these steps.

- If the `actsn` parameter will be specified for the GTA entry, and the desired ACTSN value is not shown in the `rtrv-gta` output, continue the procedure with [21](#).
 - If the `actsn` parameter will not be specified for the GTA entry, continue the procedure with [22](#).
- 21.** Display the GTT action sets in the database using the `rtrv-gttaset` command.

This is an example of the possible output.

```
rlghncxa03w 10-07-07 00:29:31 GMT EAGLE5 42.0.0
```

ACTSN	TEST	ActIds
	MODE	
act1	off	action1 (DUP),action4 (DUP),action25 (FWD), -----,-----,-----
act10	on	action20 (DUP),action4 (DUP),action21 (DUP), action25 (FWD),-----,-----
act3	off	action2 (DISC),-----,-----,

```

-----,-----,-----
act5      on   action1  (DUP),action3  (DUP),action4  (DUP),
          action20 (DUP),action21 (DUP),action17 (TCAPERR)
act11     off  action10 (UDTS),-----,-----,
          -----,-----,-----

```

GTT-ASET table is (5 of 20000) 1% full.

If the desired GTT action set is not displayed, perform the [Adding a GTT Action Set](#) procedure to add the desired GT modification entry to the database.

If the desired GT modification entry is displayed or the [Adding a GTT Action Set](#) procedure was performed, continue the procedure with [22](#).

22. Change the global title address for GTT set `LIDB` using the `chg-gta` command. Use these tables as a guide for the parameters that can be used with the `chg-gta` command.
 - [Table 4-39](#)
 - [Table 4-40](#)
 - [Table 4-41](#)
 - [Table 4-42](#)
 - [Table 4-43](#)
 - [Table 4-44](#)
 - [Table 4-45](#)
 - [Table 4-46](#)
 - [Table 4-47](#)

For this example, enter this command:

```

chg-
gta:gttsn=lidb:gta=9195554321:xlatt=dpccsn:ri=ssn:pc=001-255-2
52:ssn=254 :mapset=1:opcsn=gttset12:loopset=rtp2

```

When the command has successfully completed, this message appears.

```

rlghncxa03w 09-05-07 00:27:31 GMT EAGLE5 41.0.0
CHG-GTA: MASP A - COMPLTD

```

The command line on the terminal can contain up to 150 characters. If the parameters and values specified with the `chg-gta` command are too long to fit on the `chg-gta` command line, perform the `chg-gta` command as many times as required to complete changing the GTA entry.

23. Verify the changes to the GTT set using the `rtrv-gta` command with the `gttsn` parameter value and one of the following parameters and values specified in [22](#), depending on what type of GTT set was specified in [22](#).
 - The `gta` parameter and value – if the GTT set was a CDGTA or CGGTA GTT set, or if the GTT set had no `SETTYPE` value.
 - The `cgssn` parameter and value – if the GTT set was a CGSSN GTT set.

- The `cgpc/cgpca/cgpci/cgpcn/cgpcn24` parameter and value – if the GTT set was a CGPC GTT set.
- The `opc/opca/opci/opcn/opcn24` parameter and value – if the GTT set was an OPC GTT set.
- The `cdssn` parameter and value – if the GTT set was a CDSSN GTT set.
- The `opcode` parameter and value – if the GTT set was an OPCODE GTT set.
- The `dpc/dpca/dpci/dpcn/dpcn24` parameter and value – if the GTT set was a DPC GTT set.

If the `num` parameter is specified with the `rtrv-gta` command, and the value of the `num` parameter is greater than 1000, the `force=yes` parameter must be specified with the `rtrv-gta` command. For this example, enter this command.

```
rtrv-gta:gttsn=lidb:gta=9195554321
```

This is an example of the possible output.

```
rlghncxa03w 10-07-07 00:27:31 GMT EAGLE5 42.0.0
```

```
GTTSN      NETDOM  SETTYPE  NDGT
lidb       ansi     CDGTA    10
GTA TABLE IS  1 % FULL (17 of 26999)
```

```
START GTA  END GTA    XLAT  RI    PC
9195554321 9195554321 DPCSSN SSN    001-255-252
      MAPSET=1      SSN=254 CCGT=no CGGTMOD=NO
      GTMODID=modid2      TESTMODE=off
      LOOPSET = rtp2      FALLBACK=sysdflt
      OPTSN=----- CGSELID=----- OPCS=gttset12
      ACTSN=----- PPMEASREQD= NO
```

Command Retrieved 1 Entries

24. Back up the new changes using the `chg-db:action=backup:dest=fixed` command. These messages should appear, the active Maintenance and Administration Subsystem Processor (MASP) appears first.

```
BACKUP (FIXED) : MASP A - Backup starts on active MASP.
BACKUP (FIXED) : MASP A - Backup on active MASP to fixed disk
complete.
BACKUP (FIXED) : MASP A - Backup starts on standby MASP.
BACKUP (FIXED) : MASP A - Backup on standby MASP to fixed disk
complete.
```

Figure 4-23 Change Global Title Address Information - Sheet 1 of 15

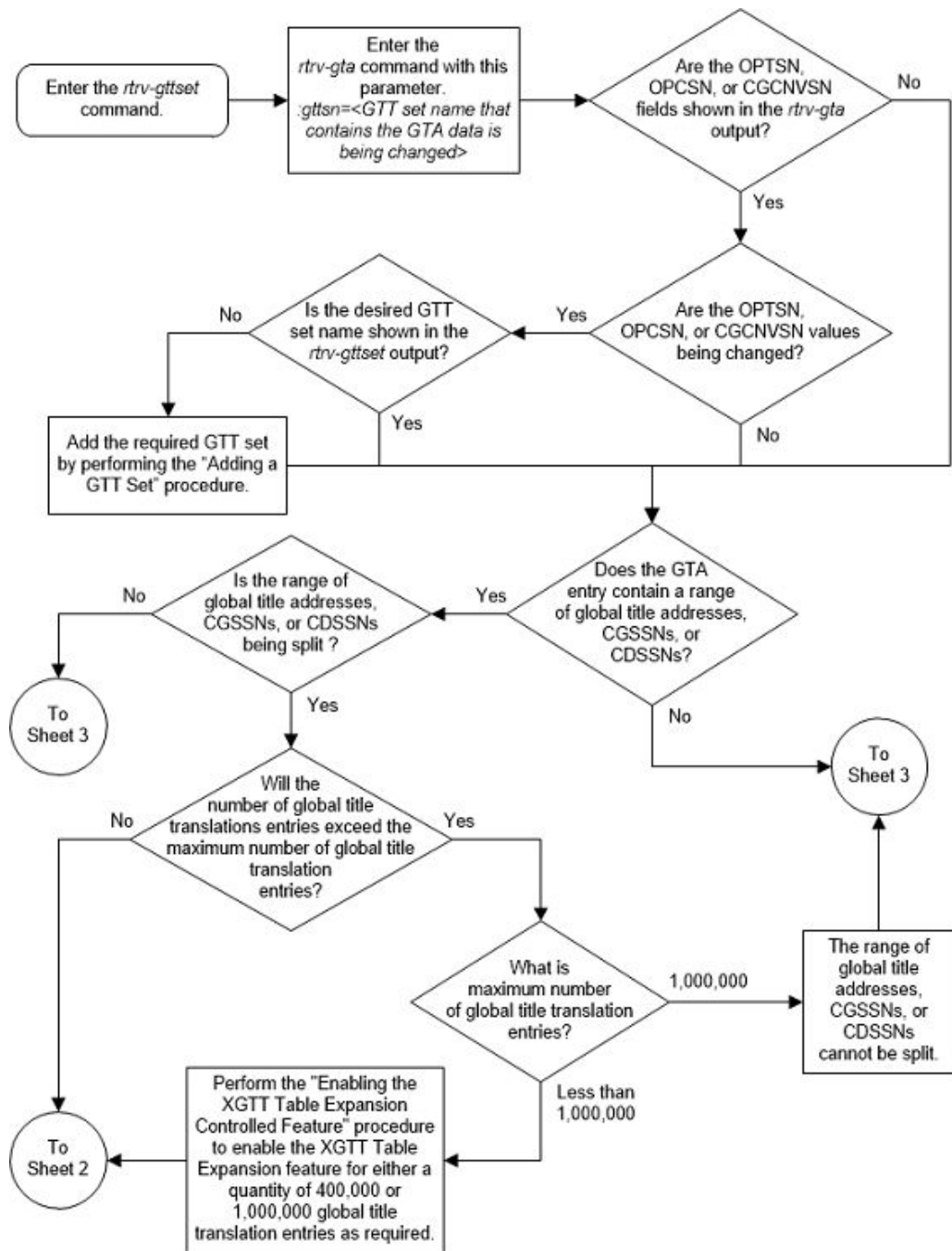

Figure 4-24 Change Global Title Address Information - Sheet 2 of 15

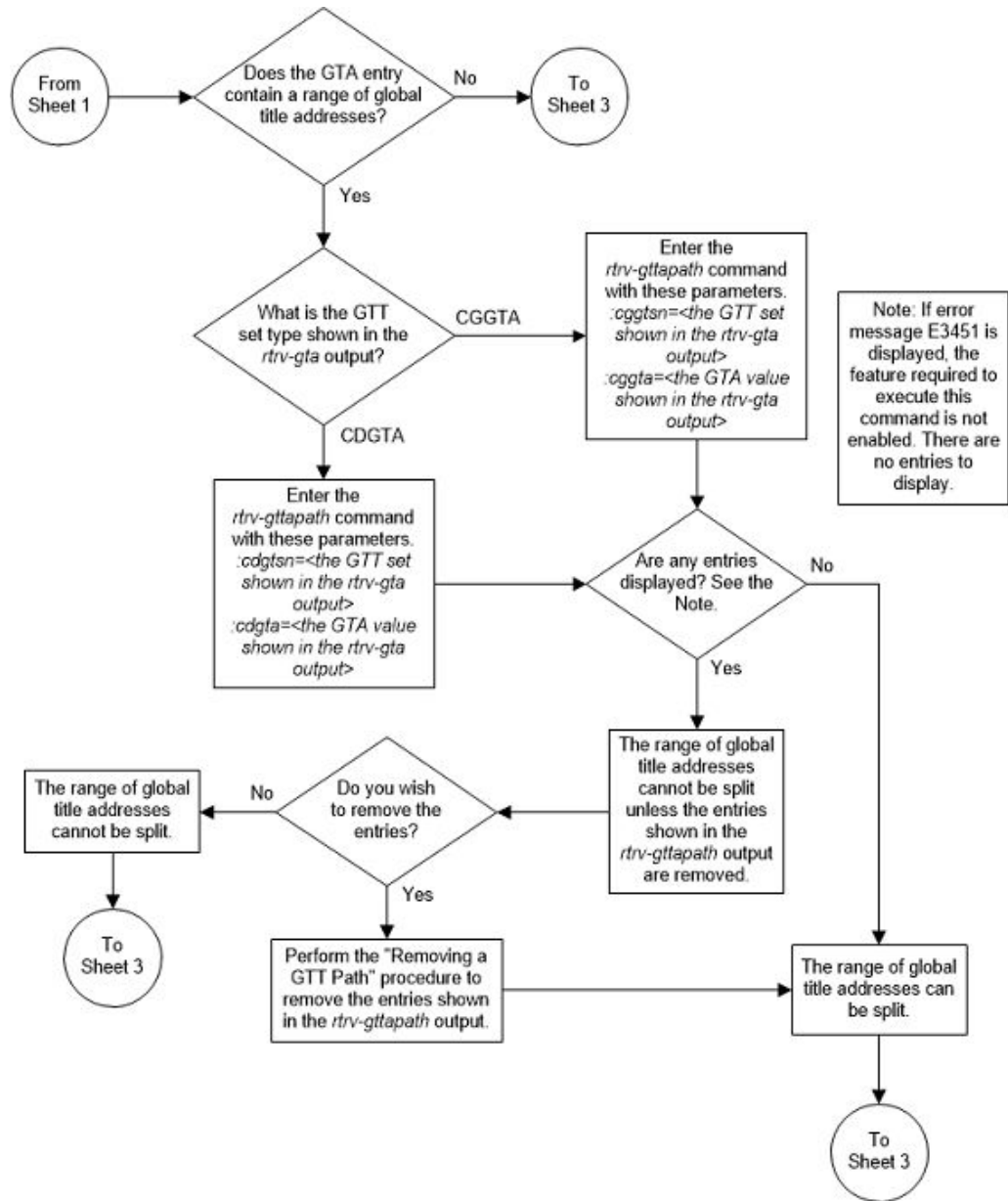

Figure 4-25 Change Global Title Address Information - Sheet 3 of 15

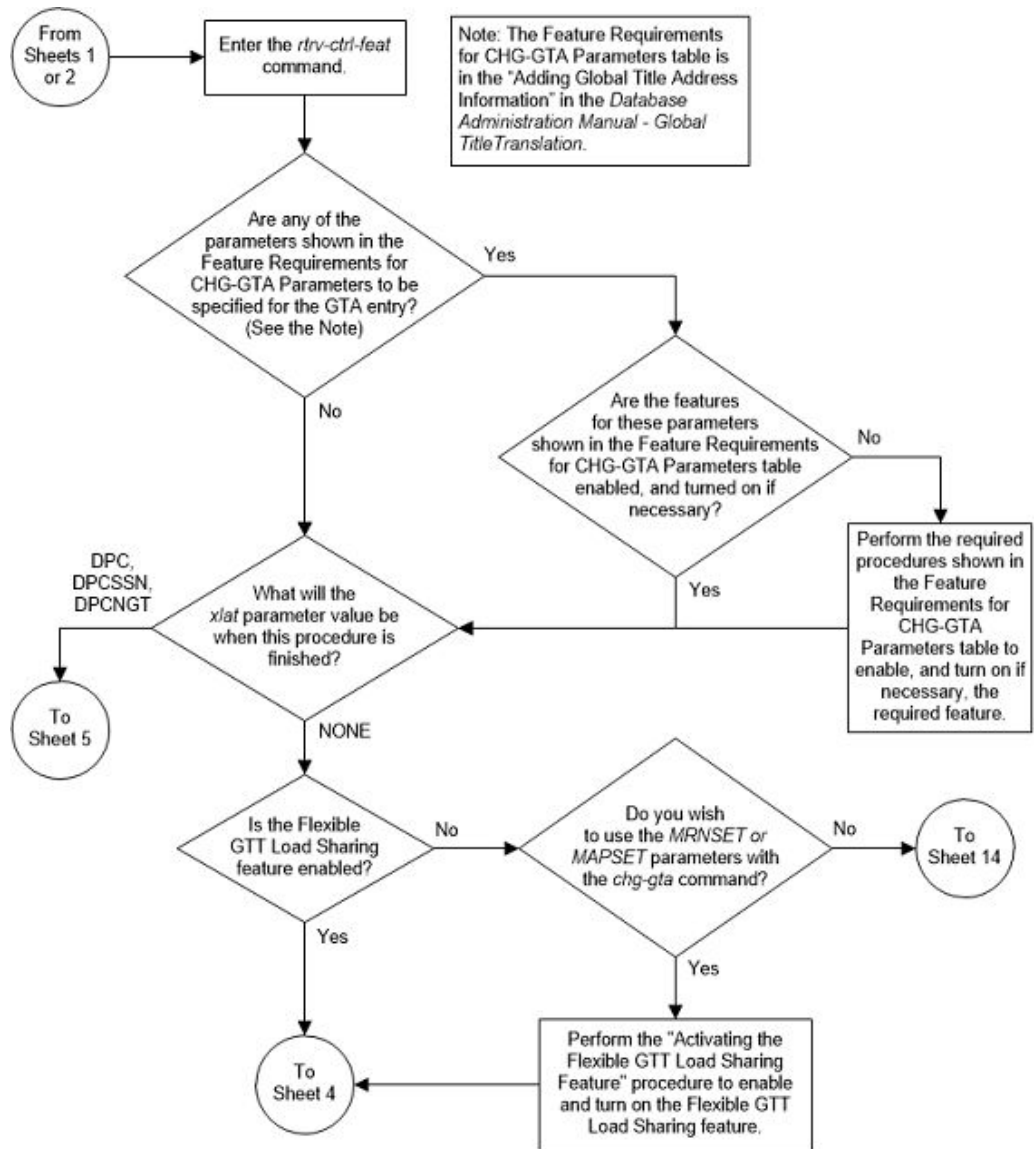

Figure 4-26 Change Global Title Address Information - Sheet 4 of 15

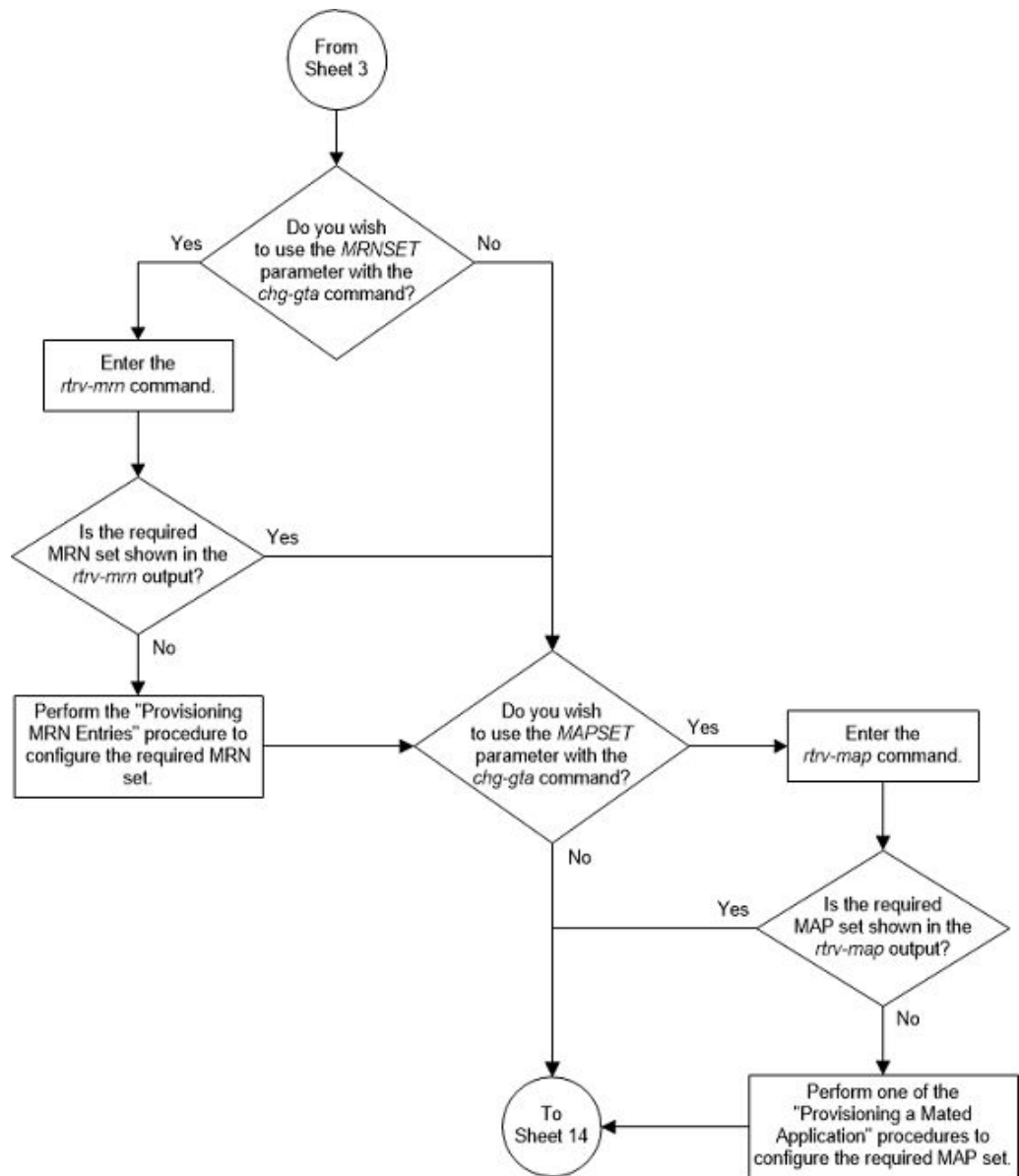

Figure 4-27 Change Global Title Address Information - Sheet 5 of 15

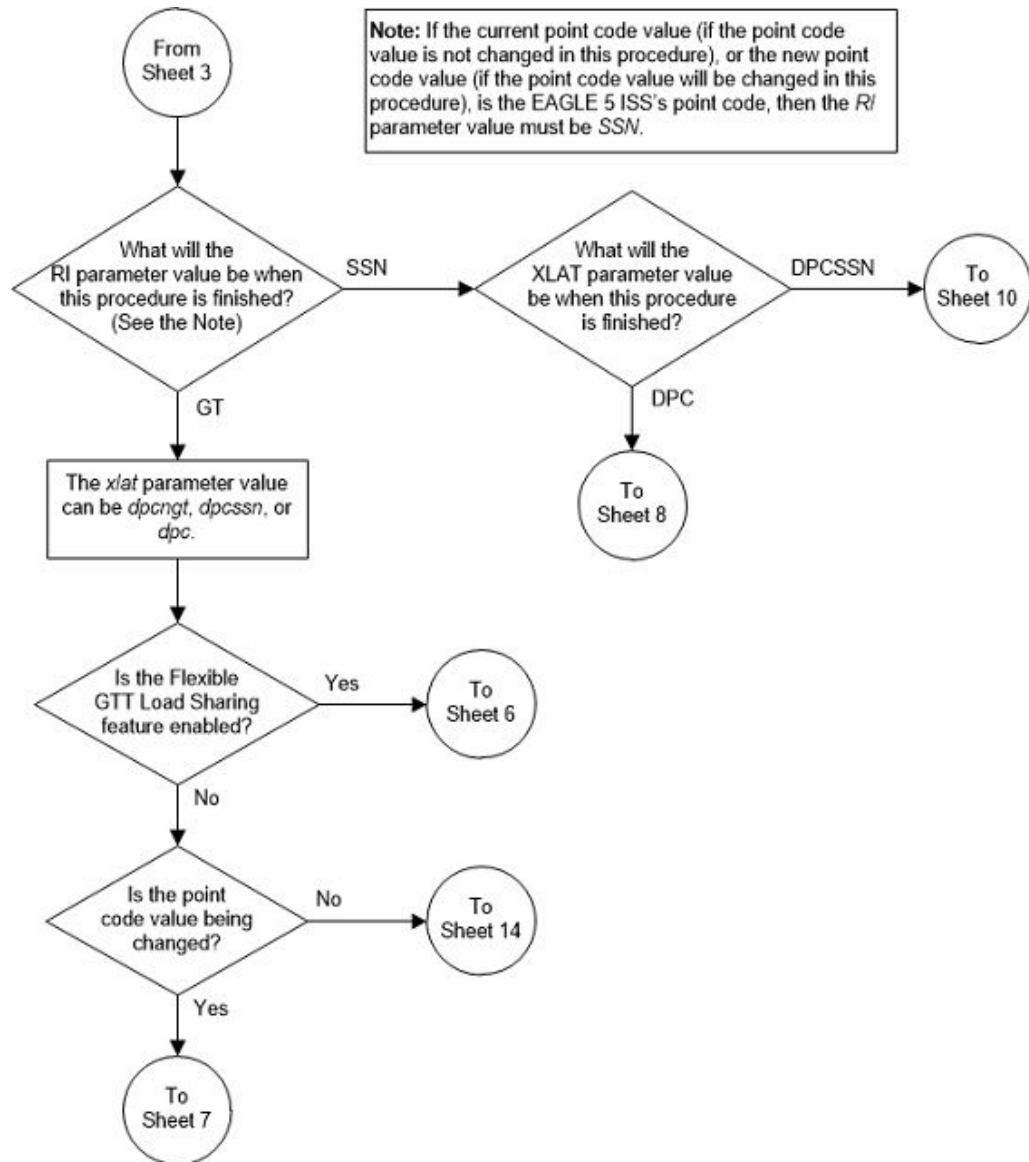

Figure 4-28 Change Global Title Address Information - Sheet 6 of 15

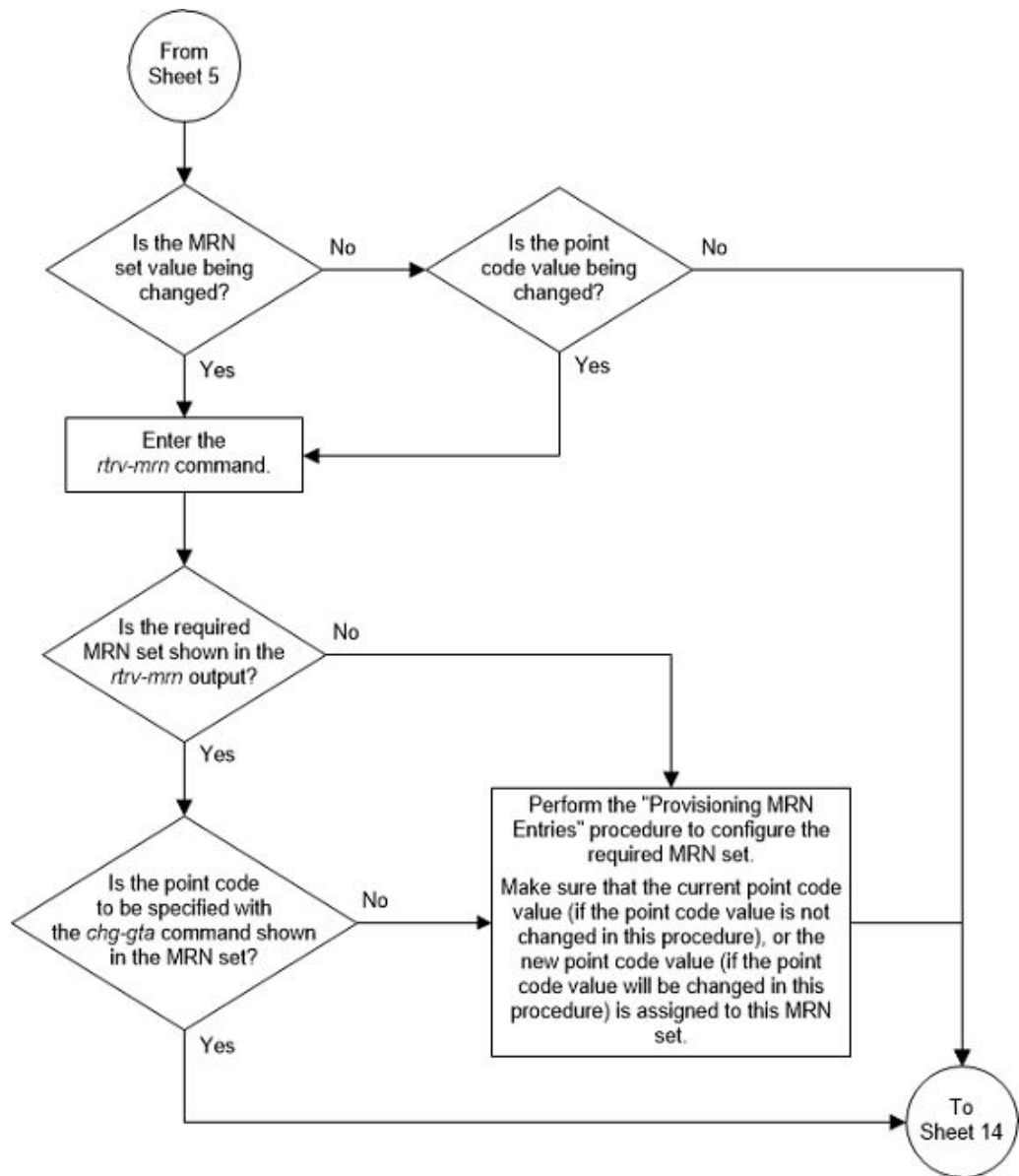

Figure 4-29 Change Global Title Address Information - Sheet 7 of 15

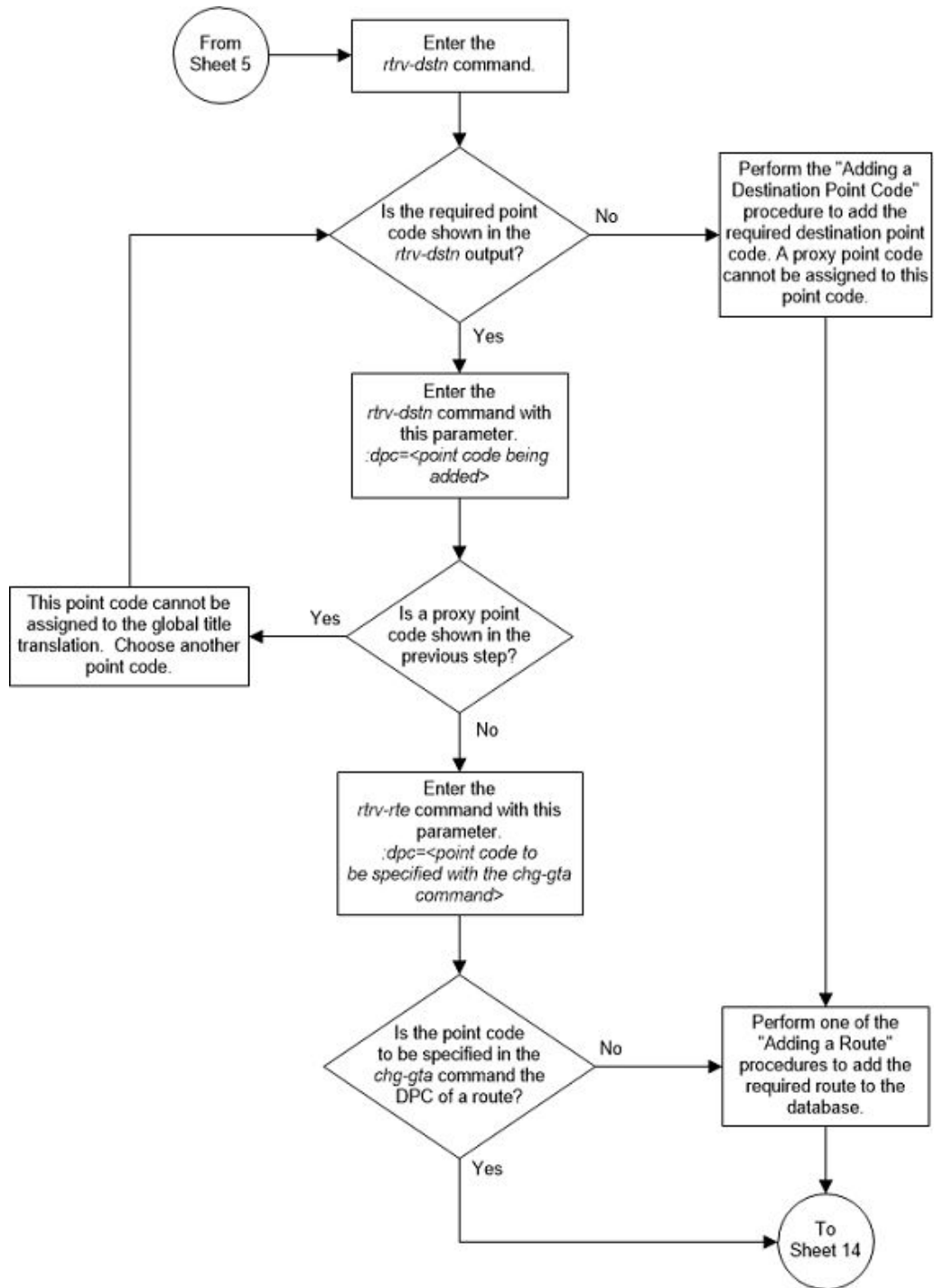

Figure 4-30 Change Global Title Address Information - Sheet 8 of 15

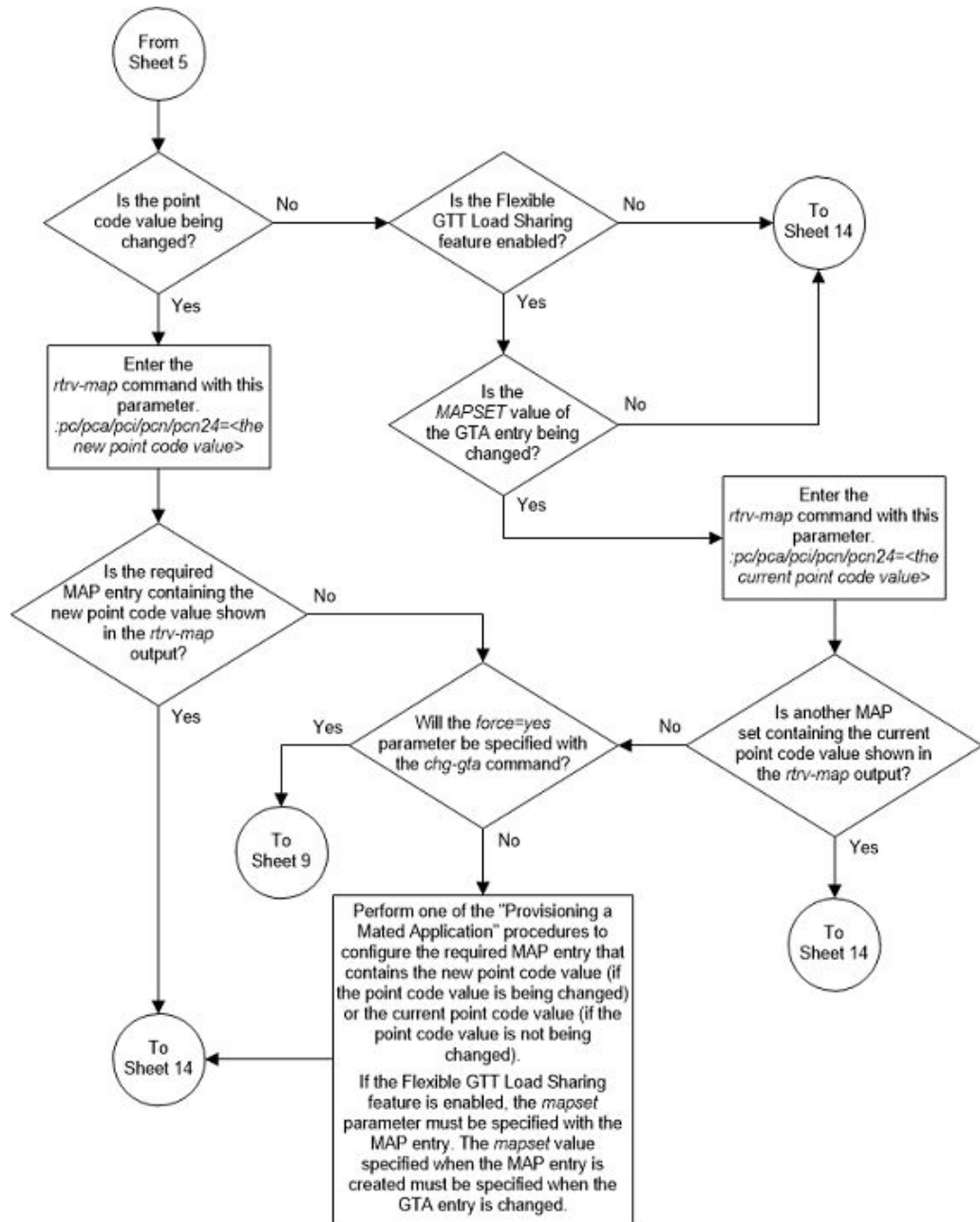

Figure 4-31 Change Global Title Address Information - Sheet 9 of 15

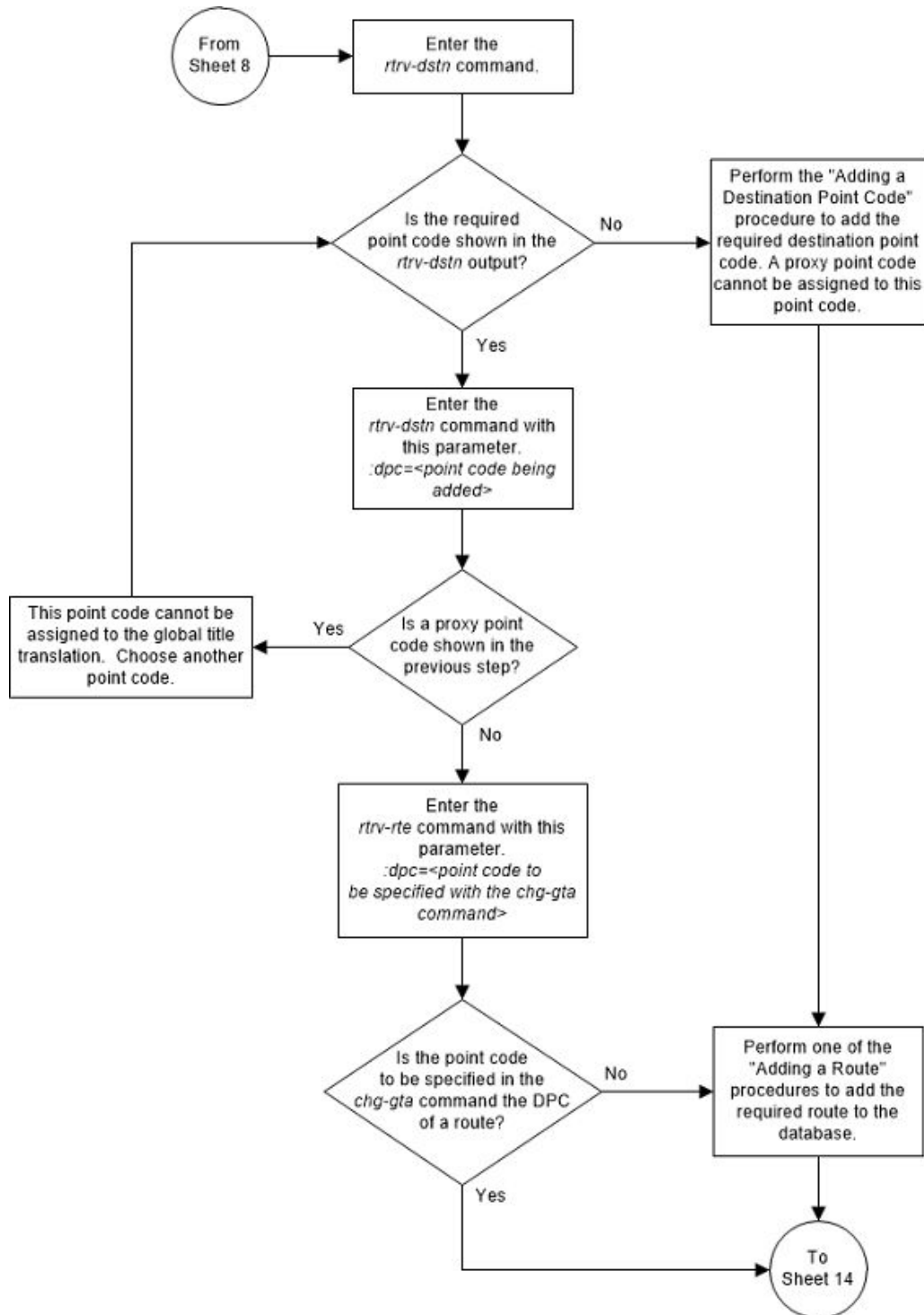

Figure 4-32 Change Global Title Address Information - Sheet 10 of 15

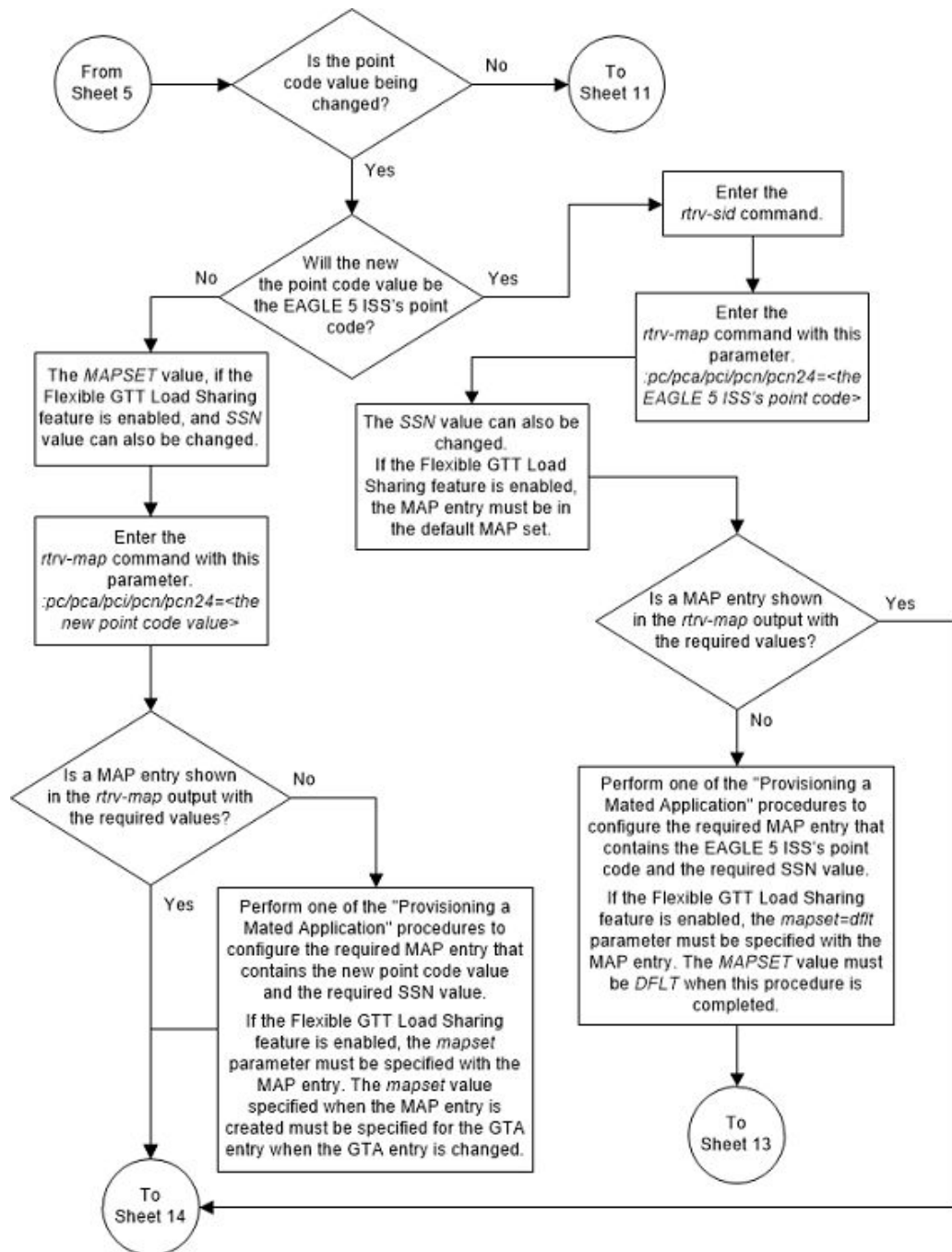

Figure 4-33 Change Global Title Address Information - Sheet 11 of 15

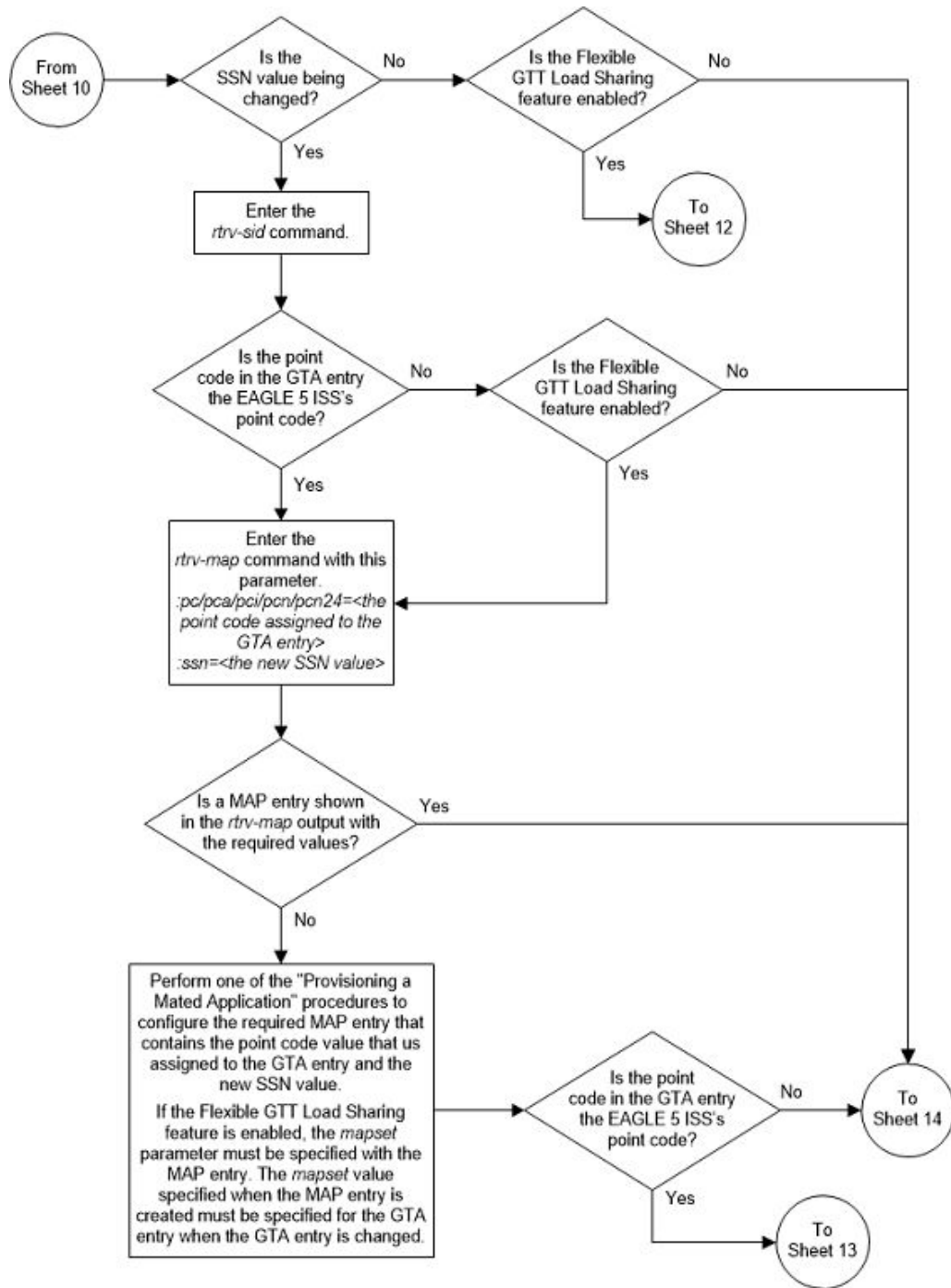

Figure 4-34 Change Global Title Address Information - Sheet 12 of 15

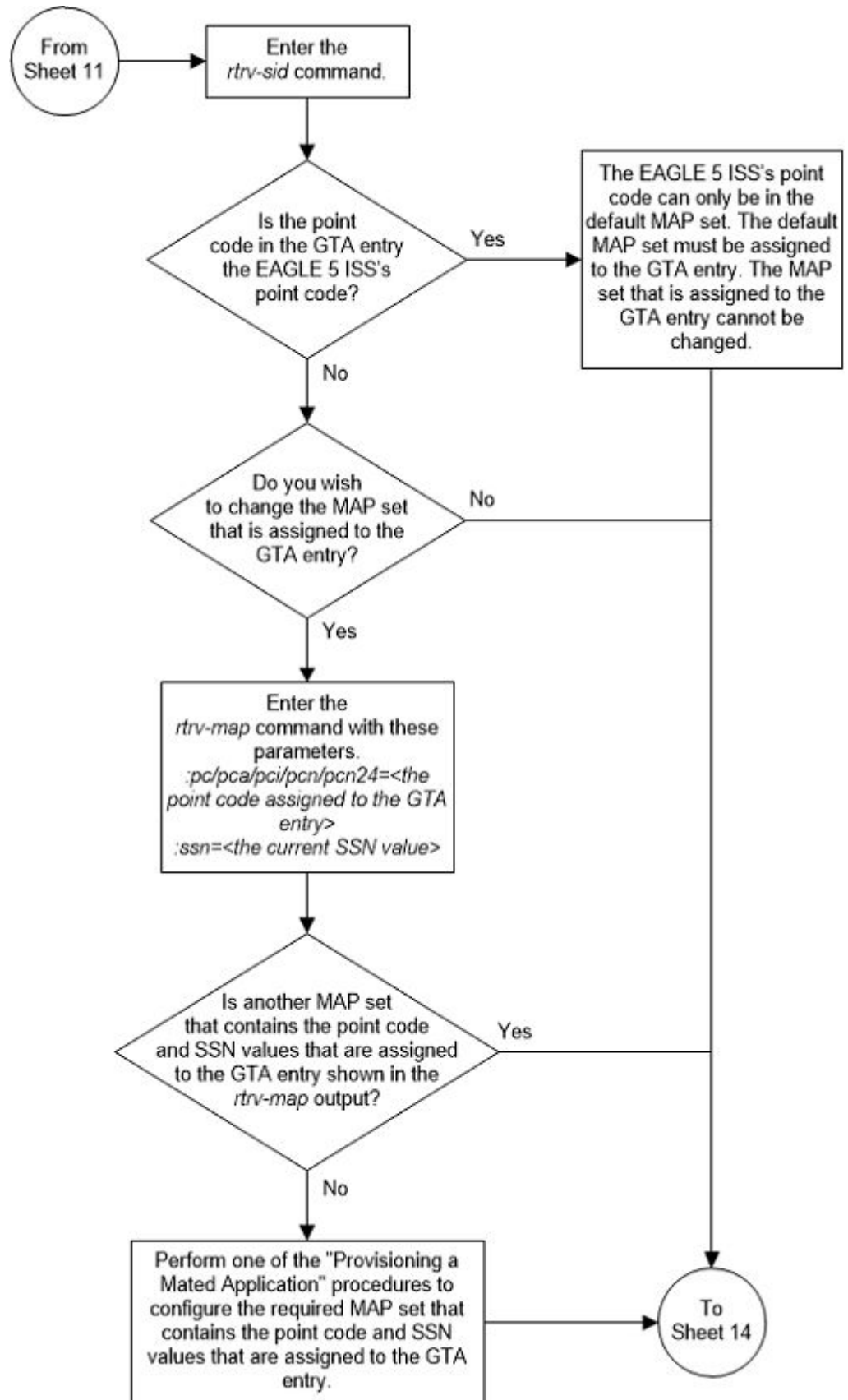

Figure 4-35 Change Global Title Address Information - Sheet 13 of 15

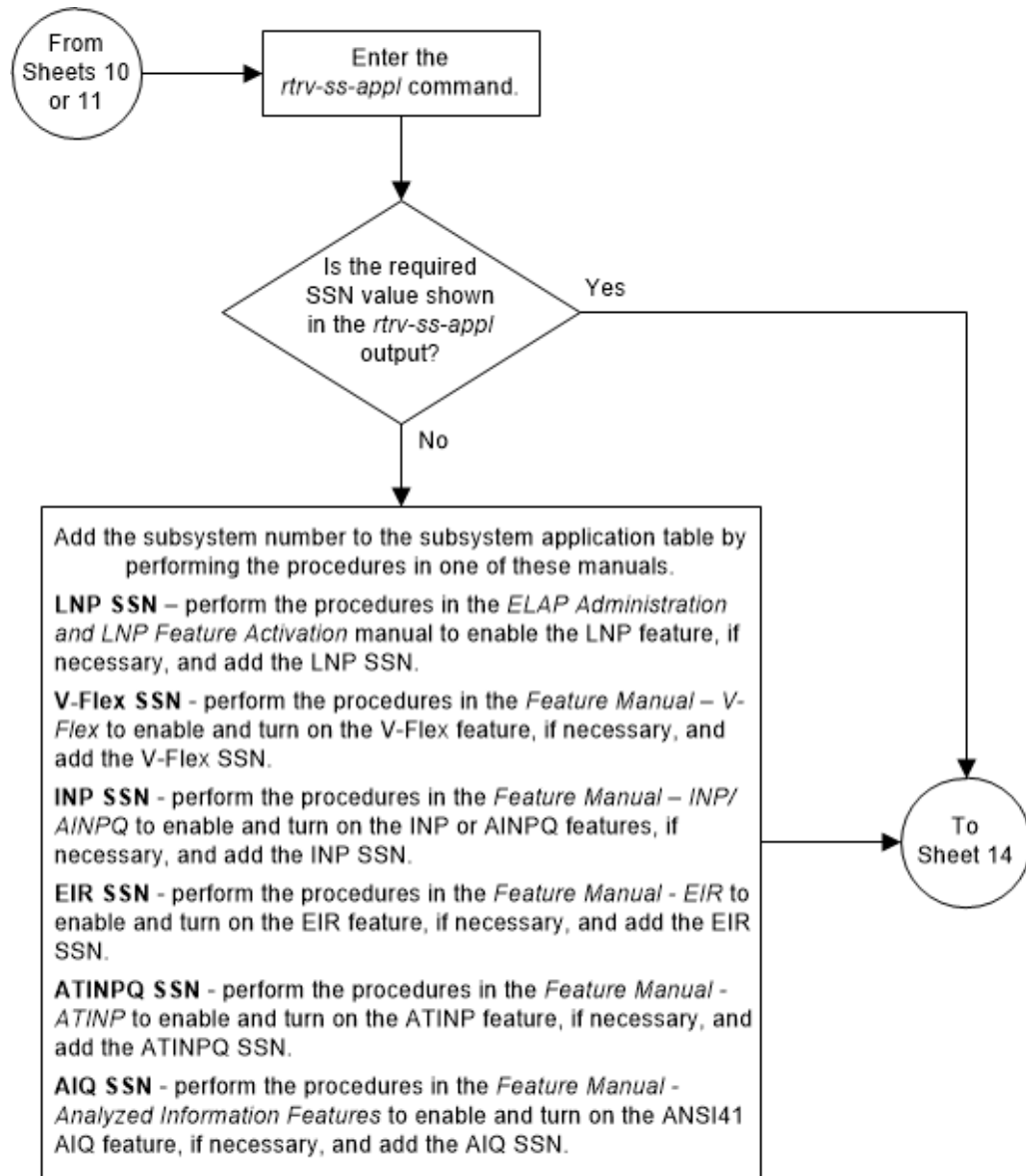

Figure 4-36 Change Global Title Address Information - Sheet 14 of 15

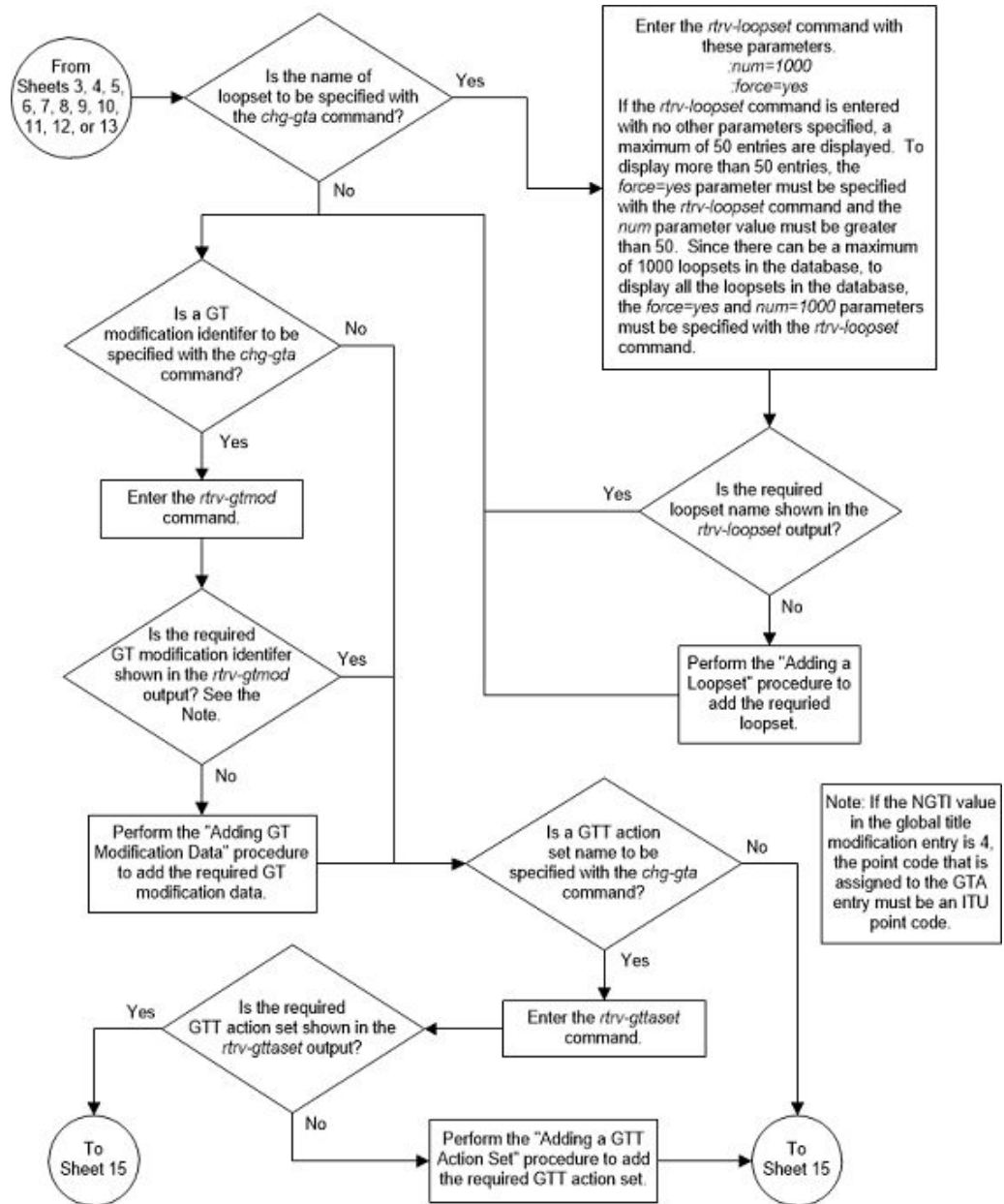
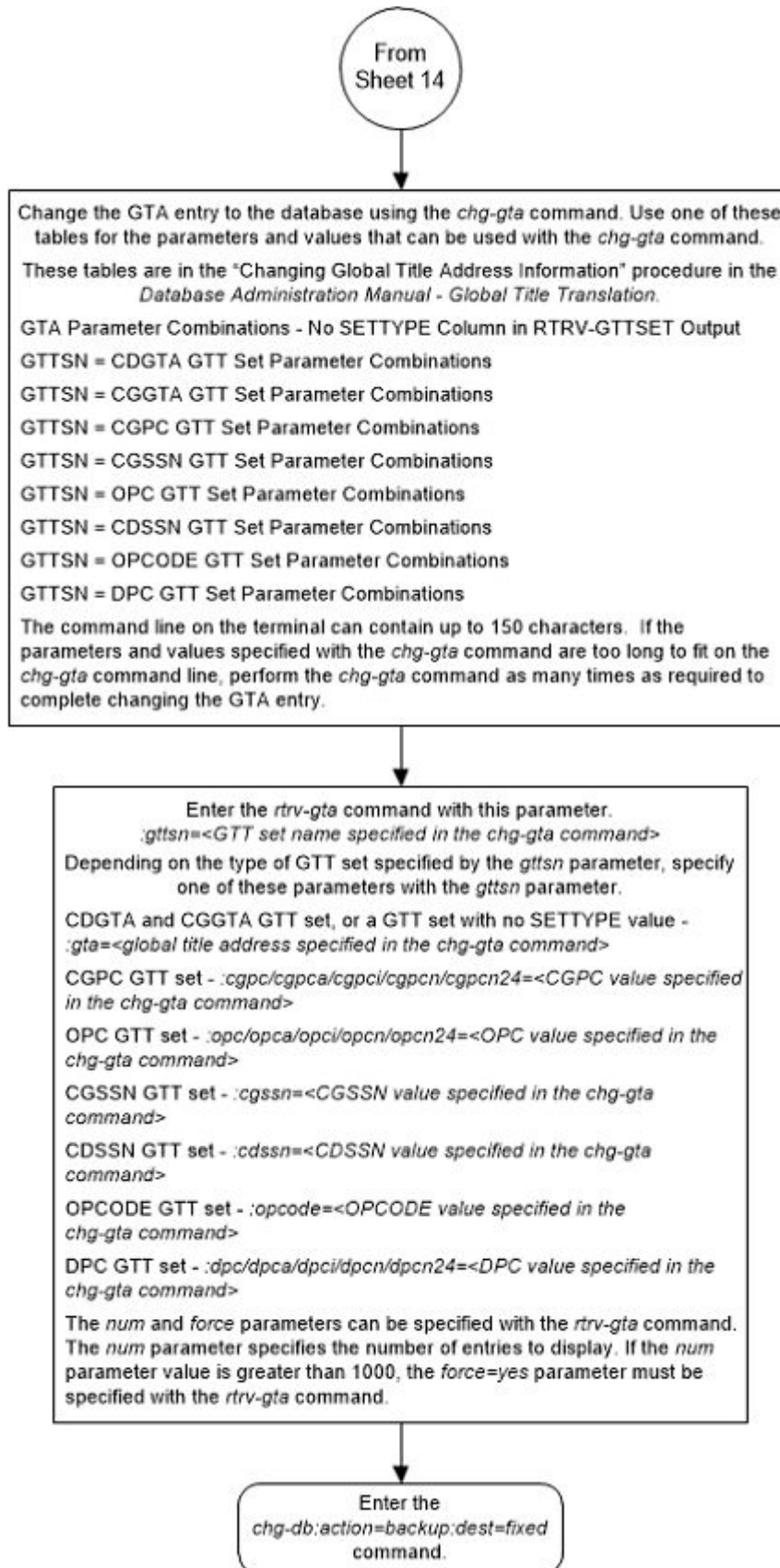

Figure 4-37 Change Global Title Address Information - Sheet 15 of 15



Changing the Default GTT Mode Options

This procedure is used to change the default GTT mode options using the `chg-sccpopts` command with these parameters.

`:dfלטgttmode` – the system default of the GTT mode hierarchy for the EAGLE to follow when performing global title translation. The values for this parameter are shown in [Table 4-50](#).

`:dfלטfallback` – the default fallback option - the action that is taken if the last translation does not match when performing global title translation using a Flexible Linkset Optional Based Routing specific GTT mode. This parameter has two values.

- `no` - Global title translation fails and the message is discarded.
- `yes` - Global title translation is performed in the message based on the last matched entry.

This procedure can be performed only if the Origin-Based SCCP Routing feature is enabled or if the Flexible Linkset Optional Based Routing feature is enabled and turned on.

For more information about the default GTT mode options, refer to the [Origin-Based SCCP Routing](#) or [Flexible Linkset Optional Based Routing](#) sections.

1. Display the existing default GTT mode values by entering the `rtrv-sccpopts` command.

This is an example of the possible output.

```
rlghncxa03w 10-07-17 16:02:05 GMT EAGLE5 42.0.0
```

```
SCCP OPTIONS
-----
DFLTGTTMODE           CdPA
DFLTFALLBACK         yes
```

The `rtrv-sccpopts` output contains other fields that are not used in this procedure. If you wish to see these fields, refer to the `rtrv-sccpopts` command description in *CommandsUser's Guide*.

To change the `DFLTFALLBACK` value to `yes`, the Flexible Linkset Optional Based Routing feature must be enabled and turned on. If the current `DFLTFALLBACK` value is `yes`, the Flexible Linkset Optional Based Routing feature is enabled and turned on.

To change the `DFLTGTTMODE` value to one of these values (a Flexible Linkset Optional Based Routing GTT mode hierarchy), the Flexible Linkset Optional Based Routing feature must be enabled and turned on. If any of these values are shown in the `rtrv-sccpopts` output for the `DFLTGTTMODE` option, the Flexible Linkset Optional Based Routing feature is enabled and turned on.

- `FLOBRCdPA`
- `FLOBRCgPA`
- `FLOBRCgPA,FLOBRCdPA`

- FLOBRCdPA,FLOBRCgPA

To change the `DFLTGTTMODE` value to one of these values (an Origin-Based SCCP Routing GTT mode hierarchy), the Origin-Based SCCP Routing feature must be enabled and turned on. If any of these values are shown in the `rtrv-sccpopts` output for the `DFLTGTTMODE` option, the Origin-Based SCCP Routing feature is enabled and turned on.

- CgPA
- AdvCdPA,CdPA
- AdvCdPA,CgPA,CdPA
- AdvCdPA,CdPA,CgPA
- CgPA,AdvCdPA,CdPA
- CgPA,CdPA
- CdPA,CgPA

The `DFLTGTTMODE` or the `DFLTFALLBACK` values must be changed in this procedure.

Continue the procedure with 4 if:

- The `DFLTGTTMODE` value will be changed to an Origin-Based SCCP Routing GTT mode hierarchy value; a value for one of the Origin-Based SCCP Routing GTT mode hierarchies (other than CdPA) is shown in the `rtrv-sccpopts` output; and the `DFLTFALLBACK` value will not be changed.
- The `DFLTGTTMODE` value will be changed to a Flexible Linkset Optional Based Routing GTT mode hierarchy value and a value for one of the Flexible Linkset Optional Based Routing GTT mode hierarchies (other than CdPA) is shown in the `rtrv-sccpopts` output. The `DFLTFALLBACK` value can also be changed to `yes`.
- The `DFLTGTTMODE` and the `DFLTFALLBACK` value will be changed to these values.
 - `DFLTGTTMODE - CdPA`
 - `DFLTFALLBACK - no`
- Only the `DFLTFALLBACK` value is changed to `no`.

If the `DFLTGTTMODE` value is being changed to an Origin-Based SCCP Routing GTT mode hierarchy, and a value for one of the Origin-Based SCCP Routing GTT mode hierarchies (other than CdPA) is not shown in the `rtrv-sccpopts` output, continue the procedure with 2.

If the `DFLTGTTMODE` value is being changed to a Flexible Linkset Optional Based Routing GTT mode hierarchy, and a value for one of the Flexible Linkset Optional Based Routing GTT mode hierarchies (other than CdPA) is not shown in the `rtrv-sccpopts` output, continue the procedure with 3.

If the `DFLTFALLBACK` value is being changed to `yes`, and a value for one of the Flexible Linkset Optional Based Routing GTT mode hierarchies (other than CdPA) is not shown in the `rtrv-sccpopts` output, continue the procedure with 3.

2. Display the status of the Origin-Based SCCP Routing feature by entering this command.

```
rtrv-ctrl-feat:partnum=893014301
```

This is an example of the possible output.

```
rlghncxa03w 10-07-07 00:29:31 GMT EAGLE5 42.0.0
The following features have been permanently enabled:
```

Feature Name	Partnum	Status	Quantity
Origin Based SCCP Routing	893014301	on	----

The following features have been temporarily enabled:

Feature Name	Partnum	Status	Quantity	Trial Period
Left				

Zero entries found.

The following features have expired temporary keys:

Feature Name	Partnum
Zero entries found.	

If the Origin-Based SCCP Routing feature is not enabled or turned on, perform [Activating the Origin-Based SCCP Routing Feature](#) to enable and turn on the Origin-Based SCCP Routing feature.

After [Activating the Origin-Based SCCP Routing Feature](#) has been performed, or if the `rtrv-ctrl-feat` output shows that the Origin-Based SCCP Routing feature is enabled and turned on, continue the procedure by performing one of these steps.

- If only the `DFLTGTTMODE` value is being changed to an Origin-Based SCCP Routing GTT mode hierarchy (other than CdPA), continue the procedure with [4](#).
 - If the `DFLTFALLBACK` value will be changed to `yes`, and a value for one of the Flexible Linkset Optional Based Routing GTT mode hierarchies (other than CdPA) is not shown in the `rtrv-sccpopts` output, continue the procedure with [3](#).
- 3.** Display the status of the Flexible Linkset Optional Based Routing feature by entering this command.

```
rtrv-ctrl-feat:partnum=893027701
```

This is an example of the possible output.

```
rlghncxa03w 10-07-07 00:29:31 GMT EAGLE5 42.0.0
The following features have been permanently enabled:
```

Feature Name	Partnum	Status	Quantity
Flex Lset Optnl Based Rtg	893027701	on	----

The following features have been temporarily enabled:

Feature Name	Partnum	Status	Quantity	Trial Period
Left				

Zero entries found.

The following features have expired temporary keys:

Feature Name	Partnum
Zero entries found.	

If the Flexible Linkset Optional Based Routing feature is not enabled or turned on, perform [Activating the Flexible Linkset Optional Based Routing Feature](#) to enable and turn on the Flexible Linkset Optional Based Routing.

After [Activating the Flexible Linkset Optional Based Routing Feature](#) has been performed as needed, or if the `rtrv-ctrl-feat` output shows that the Flexible Linkset Optional Based Routing feature is enabled and turned on, continue the procedure with 4.

4. Change the default GTT mode values using the `chg-sccpopts` command and with at least one of the parameters and values shown in [Table 4-50](#).

Table 4-50 Default GTT Mode Option Parameter Combinations

Origin-Based SCCP Routing Feature Enabled and Turned On Only	Flexible Linkset Optional Based Routing Feature (FLOBR) Enabled and Turned On Only	Origin-Based SCCP Routing Feature and Flexible Linkset Optional Based Routing Feature (FLOBR) Enabled and Turned On
:dfiltgttmode= one of these values	:dfiltgttmode= one of these values	:dfiltgttmode= one of these values
cd - CdPA GTT only cg - CgPA GTT only acdcd - Advanced CdPA GTT, CdPA GTT acdcg - Advanced CdPA GTT, CgPA GTT, CdPA GTT acdcdcg - Advanced CdPA GTT, CdPA GTT, CgPA GTT cgacdcd - CgPA GTT, Advanced CdPA GTT, CdPA GTT cgcd - CgPA GTT, CdPA GTT cdcg - CdPA GTT, CgPA GTT	cd - CdPA GTT only fcd - FLOBR CdPA fcg - FLOBR CgPA fcdfcg - FLOBR CdPA, FLOBR CgPA fcgfcg - FLOBR CgPA, FLOBR CdPA	cd - CdPA GTT only cg - CgPA GTT only acdcd - Advanced CdPA GTT, CdPA GTT acdcg - Advanced CdPA GTT, CgPA GTT, CdPA GTT acdcdcg - Advanced CdPA GTT, CdPA GTT, CgPA GTT cgacdcd - CgPA GTT, Advanced CdPA GTT, CdPA GTT cgcd - CgPA GTT, CdPA GTT cdcg - CdPA GTT, CgPA GTT fcd - FLOBR CdPA fcg - FLOBR CgPA fcdfcg - FLOBR CdPA, FLOBR CgPA fcgfcg - FLOBR CgPA, FLOBR CdPA
	:dfiltfallback=<yes, no>	:dfiltfallback=<yes, no>

For this example, enter this command.

```
chg-sccpopts:dfltgttmode=acdcd:dfltfallback=no
```

When the `chg-sccpopts` command has successfully completed, this message should appear.

```
rlghncxa03w 10-07-07 00:22:57 GMT EAGLE5 42.0.0  
CHG-SCCPOPTS: MASP A - COMPLTD
```

5. Verify the changes using the `rtrv-sccpopts` command. This is an example of the possible output.

```
rlghncxa03w 10-07-17 16:02:05 GMT EAGLE5 42.0.0
```

```
SCCP OPTIONS  
-----  
DFLTGTTMODE          AdvCdPA,CdPA  
DFLTFALLBACK                no
```

The `rtrv-sccpopts` output contains other fields that are not used in this procedure. If you wish to see these fields, refer to the `rtrv-sccpopts` command description in *Commands User's Guide*.

6. Back up the new changes using the `chg-db:action=backup:dest=fixed` command. These messages should appear, the active Maintenance and Administration Subsystem Processor (MASP) appears first.

```
BACKUP (FIXED) : MASP A - Backup starts on active MASP.  
BACKUP (FIXED) : MASP A - Backup on active MASP to fixed disk  
complete.  
BACKUP (FIXED) : MASP A - Backup starts on standby MASP.  
BACKUP (FIXED) : MASP A - Backup on standby MASP to fixed disk  
complete.
```

Figure 4-38 Change the Default GTT Mode Options - Sheet 1 of 3

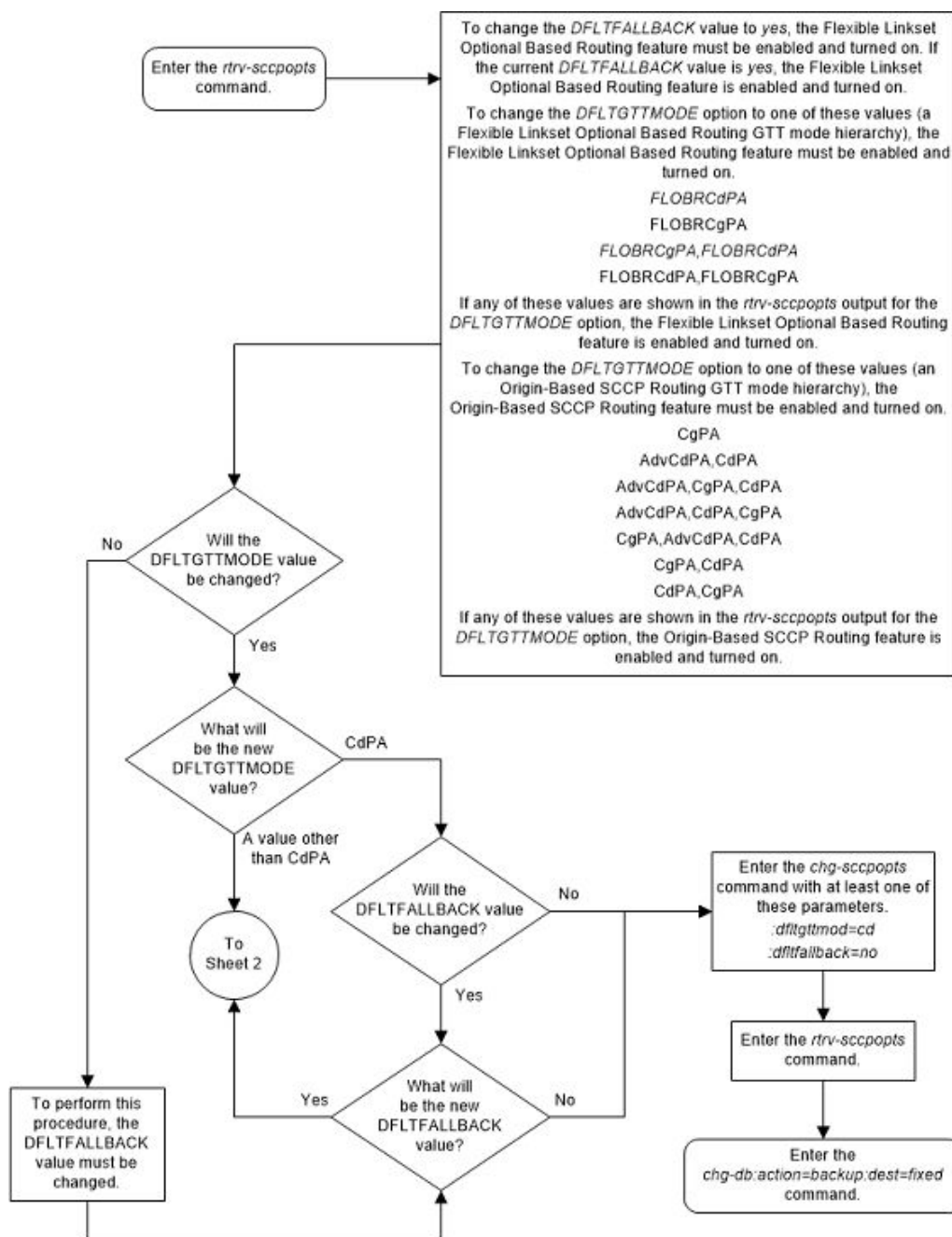

Figure 4-39 Change the Default GTT Mode Options - Sheet 2 of 3

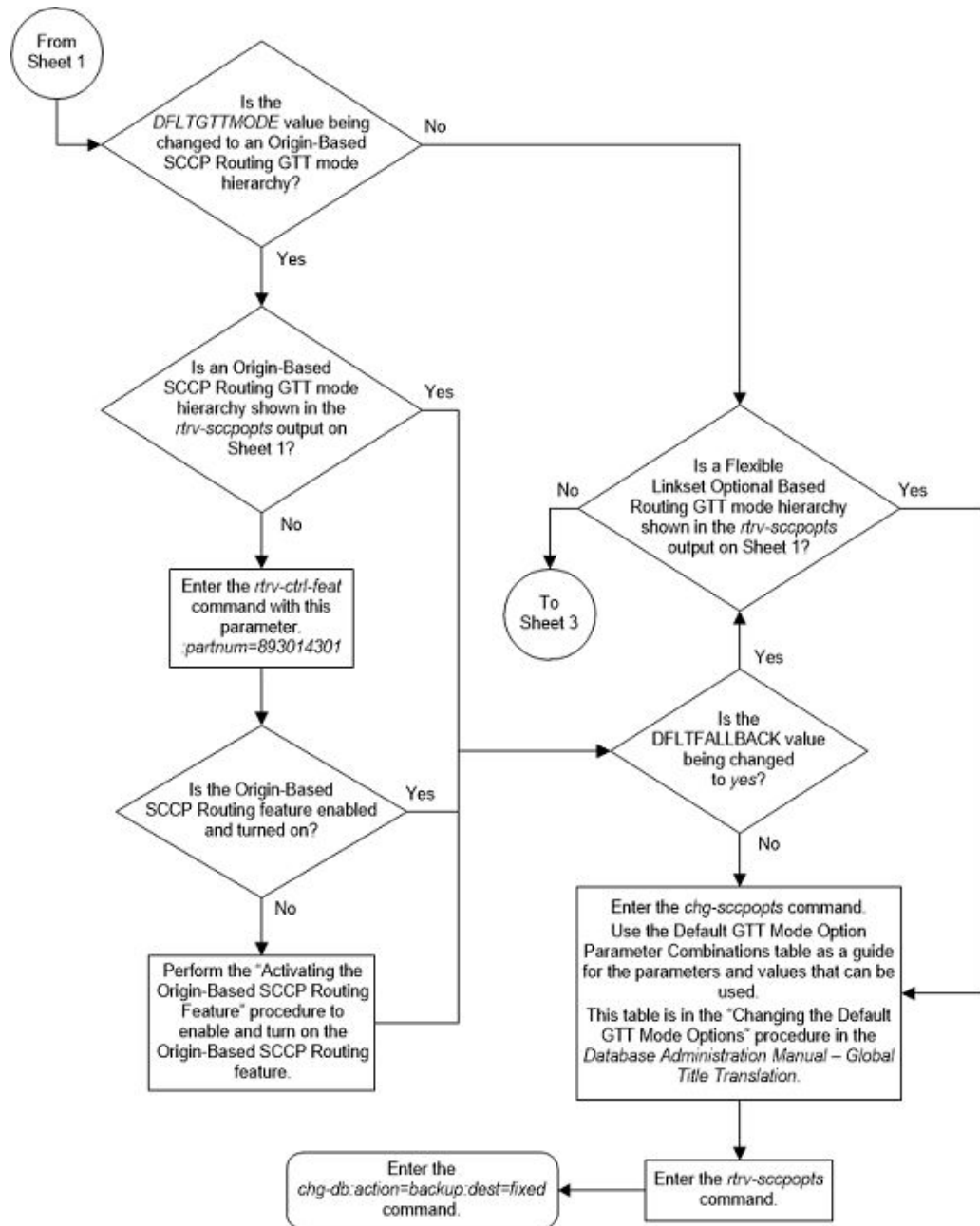
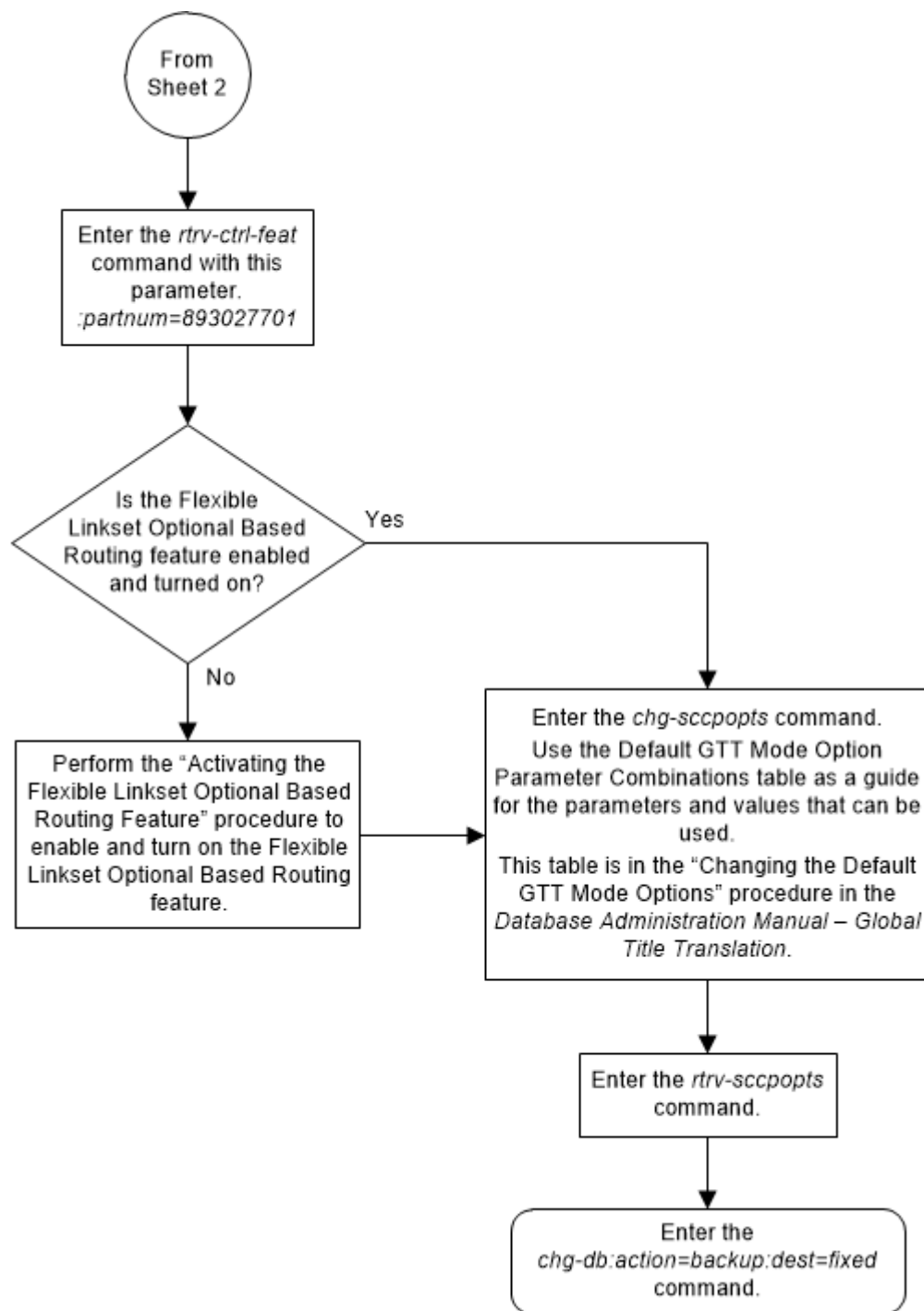

Figure 4-40 Change the Default GTT Mode Options - Sheet 3 of 3



Adding a GTT Action

This procedure is used to add a GTT action to the database using the `ent-gttact` command.

The `ent-gttact` command uses these parameters.

:act - the action that is applied to the message. This parameter has these values.

- disc — discard the message with no return error.
- dup — route a copy of the message to the specified duplicate node.
- tcaperr — discard the message that has the specified TCAP error.
- udts — discard the message and send an UDTS/XUDTS.
- fwd — route the original message to the specified forward node instead of the destination indicated by the global title translation data.

:actid - the name of the GTT action entry.

:atcaperr - the ANSI TCAP error cause - the reason for discarding the message containing the ANSI TCAP portion that is associated with the TCAP error GTT action.

:cdgtmodid - the name of the GT modification identifier that is associated with the called party of a GTT action entry.

:cggmodid - the name of the GT modification identifier that is associated with the calling party of a GTT action entry.

:cgpc/cgpc/cgpci/cgpcn/cgpcn24 - the calling party point code.

 **Note:**

See Chapter 2, "Configuring Destination Tables," in *Database Administration - SS7 User's Guide* for a definition of the point code types that are used on the EAGLE and for a definition of the different formats that can be used for ITU national point codes.

:cgpcogmsg - the data that is used as the calling party point code in the outgoing message.

:defactid - the default GTT action ID that is associated with the forward GTT action.

:itcaperr - the ITU TCAP error cause - the reason for discarding the message containing the ITU TCAP portion that is associated with the TCAP error GTT action.

:loopset - the name of the SCCP loopset name that is associated with the GTT action.

:mapset - the MAP set ID.

:mrnset - the MRN set ID.

:off - turns off the specified feature options.

- :off=uimreqd - a UIM is not generated.
- :off=useicmsg - apply the GTT action data to the message as the message was received.

:on - turns on the specified feature options.

- :on=uimreqd - a UIM is generated.
- :on=useicmsg - apply the GTT action data to the message after any EPAP or GTT translation/modification data has been applied.

:pc/pca/pci/pcn/pcn24 - the point code that the message will be routed to as a result of the duplicate or forward GTT action.

 **Note:**

See Chapter 2, "Configuring Destination Tables," in *Database Administration - SS7 User's Guide* for a definition of the point code types that are used on the EAGLE and for a definition of the different formats that can be used for ITU national point codes.

:ri - the routing indicator in the SCCP called party address of the duplicated copy of MSU.

:ssn - the subsystem number (SSN) in the SCCP called party address of the MSU.

:udtserr - the reason associated with the UDTs GTT action for discarding the message.

The values for the actid, atcaperr, itcaperr, udtser, pc/pca/pci/pcn/pcn24, ri, mrnset, mapset, ssn, loopset, cggtmodid, cdgtmodid, defactid, and cgpc/cgpcac/cgpci/cgpcn/cgpcn24 parameters are shown in [Table 4-51](#).

To add a GTT action to the database, one of these features must be enabled, depending on the act parameter value that will be specified with the GTT action.

- act=disc, act=udts, act=tcaperr - GTT Action - DISCARD feature - part number 893027501.
- act=dup - GTT Action - DUPLICATE feature - part number 893027601.
- act=fwd - GTT Action - FORWARD feature - part number 893037501.

The status of these features is shown in the rtrv-ctrl-feat output. Perform the [Activating the GTT Actions Features](#) procedure to enable one or more of these features.

The EAGLE database can contain a maximum of 2000 GTT action entries.

1. Display the GTT action entries in the database by entering the rtrv-gttact command. This is an example of the possible output.

```
rlghncxa03w 10-07-07 00:29:31 GMT EAGLE5 42.0.0
```

```
ACTID      ACTION    ATCAPERR  ITCAPERR  UDTSEERR  UIMREQD
-----
action2    disc      ---       ---       ---       off
```

```
ACTID      ACTION    PCA        RI  SSN  MRNSET  MAPSET
-----
---
action1    dup      002-002-002  gt  ---  DFLT    -----
          CDGTMODID = -----  CCGTMODID = -----
          LOOPSET = None
          USEICMSG = off      CGPCOGMSG = dflt      CGPCA = ---
```

```

ACTID      ACTION  PCI          RI  SSN  MRNSET  MAPSET
-----
---
```

```

ACTID      ACTION  PCN          RI  SSN  MRNSET  MAPSET
-----
---
```

```

ACTID      ACTION  PCN24       RI  SSN  MRNSET  MAPSET
-----
---
```

GTT-ACT table is (2 of 2000) 1% full.

If no entries are displayed, continue the procedure with 2.

If the number of entries that are displayed is 2000, this procedure cannot be performed. This is the maximum number of GTT action entries that can be in the database.

If there are less 2000 entries shown in the `rtrv-gttact` output, continue the procedure by performing one of these steps.

- If entries are shown in the `rtrv-gttact` output that contain the `act` parameter value of the new entry, continue the procedure by performing one of these steps.
 - If the `act` parameter value for the new entry will be `disc`, `udts`, or `tcaperr`, continue the procedure with 14.
 - If the `act` parameter value for the new entry will be `dup` or `fwd`, continue the procedure with 3.
 - If the `act` parameter value of the new entry is not shown in the `rtrv-gttact` output, continue the procedure with 2.
2. Display the features that are enabled by entering the `rtrv-ctrl-feat` command.

The following is an example of the possible output.

```

rlghncxa03w 10-07-28 21:15:37 GMT EAGLE5 42.0.0
The following features have been permanently enabled:
```

Feature Name	Partnum	Status	Quantity
Command Class Management	893005801	on	----
LNP Short Message Service	893006601	on	----
Intermed GTT Load Sharing	893006901	on	----
HC-MIM SLK Capacity	893012707	on	64

The following features have been temporarily enabled:

Feature Name	Partnum	Status	Quantity	Trial
Period Left				

Zero entries found.

The following features have expired temporary keys:

Feature Name	Partnum
Zero entries found.	

To add a GTT action to the database, one of these features must be enabled, depending on the `act` parameter value that will be specified with the GTT action.

- `act=disc, act=udts, act=tcaperr` - GTT Action - DISCARD feature - part number 893027501.
- `act=dup` - GTT Action - DUPLICATE feature - part number 893027601.
- `act=fwd` - GTT Action - FORWARD feature - part number 893037501.

If the required feature is not enabled, perform the [Activating the GTT Actions Features](#) procedure to enable the required feature.

After the [Activating the GTT Actions Features](#) procedure has been performed, or if the required is enabled as shown in this step, continue the procedure by performing one of these steps.

- If the `act` parameter value for the new entry will be `disc`, `udts`, or `tcaperr`, continue the procedure with [14](#).
 - If the `act` parameter value for the new entry will be `dup` or `fwd`, continue the procedure with [3](#).
3. For GTT action entries whose `act` value will be either `dup` or `fwd`, the `ri` parameter must be specified for the GTT action entry.

If the `ri` parameter value for the GTT action entry will be `gt`, the `pc/pca/pci/pcn/pcn24` parameter must be specified for the GTT action entry. The point code must be the DPC of a route and cannot contain a proxy point code.

If the `MRNSET` column is shown in the `rtrv-gttact` output, the Flexible GTT Load Sharing feature is enabled. If the Flexible GTT Load Sharing feature is enabled, the `mrnset` parameter must be specified for the GTT action entry. The point code that will be assigned to the GTT action entry must be in an MRN set. MRN sets are shown in the `rtrv-mrn` output.

If the `ri` parameter value for the GTT action entry will be `ssn`, the `pc/pca/pci/pcn/pcn24` and `ssn` parameters must be specified for the GTT action entry. The point code and `ssn` values must be in the `rtrv-map` output.

If the `MAPSET` column is shown in the `rtrv-gttact` output, the Flexible GTT Load Sharing feature is enabled. If the Flexible GTT Load Sharing feature is enabled, the `mapset` parameter must be specified for the GTT action entry. The point code and `ssn` values that will be assigned to the GTT action entry must be in a MAP set. MAP sets are shown in the `rtrv-map` output.

If the `ri` value for the GTT action entry will be `gt`, the `MRNSET` column is not shown in the `rtrv-gttact` output, the `mrnset` parameter will not be specified for the GTT action entry, and the point code value for the GTT action entry is not shown in the `rtrv-gttact` output, continue the procedure with [5](#).

If you wish to specify the `mrnset` parameter for the GTT action entry, perform these procedures to configure the MRNSET with the required MRNSET with the point code value: [Activating the Flexible GTT Load Sharing Feature](#)

and [Provisioning MRN Entries](#). After these procedures have been performed, continue the procedure with [11](#).

If the `ri` value for the GTT action entry will be `gt`, the `MRNSET` column is shown in the `rtrv-gttact` output, and the point code and `MRNSET` values for the GTT action entry are not shown in the `rtrv-gttact` output, continue the procedure with [4](#).

If the `ri` value for the GTT action entry will be `ssn`, the `MAPSET` column is not shown in the `rtrv-gttact` output, the `mapset` parameter will not be specified for the GTT action entry, and the point code and `SSN` values for the GTT action entry is not shown in the `rtrv-gttact` output, continue the procedure with [8](#).

If you wish to specify the `mapset` parameter for the GTT action entry, perform the [Activating the Flexible GTT Load Sharing Feature](#) procedure to enable the Flexible GTT Load Sharing Feature. After this procedure has been performed, continue the procedure with [8](#).

If the `ri` value for the GTT action entry will be `ssn`, the `MAPSET` column is shown in the `rtrv-gttact` output, and the point code, `SSN`, and `MAPSET` values for the GTT action entry are not shown in the `rtrv-gttact` output, continue the procedure with [8](#).

4. Display the MRN entries entering the `rtrv-mrn` command.

This is an example of the possible output.

```
rlghncxa03w 10-07-28 21:15:37 GMT EAGLE5 42.0.0
```

MRNSET	PC	RC
DFLT	002-002-002	1
	003-003-003	2
MRNSET	PC	RC
1	003-003-003	2
	004-004-004	3
	005-005-005	4

```
MRN table is (5 of 6000) 1% full.
```

If the required MRN set is shown in the `rtrv-mrn` output, continue the procedure with [11](#).

If the required MRN set is not shown in the `rtrv-mrn` output, perform the [Provisioning MRN Entries](#) procedure to provision the required MRN set. After the [Provisioning MRN Entries](#) procedure has been performed, continue the procedure with [11](#).

5. Display the destination point codes in the database by entering the `rtrv-dstn` command. This is an example of the possible output.

```
rlghncxa03w 10-12-10 11:43:04 GMT EAGLE5 43.0.0
Extended Processing Time may be Required
```

DPCA	CLLI	BEI	ELEI	ALIASI
ALIASN/N24	DMN			
001-207-000	-----	no	---	-----
-----	SS7			

```

001-001-001 ----- no --- -----
-----
SS7
001-001-002 ----- no --- -----
-----
SS7
001-005-000 ----- no --- -----
-----
SS7
001-007-000 ----- no --- -----
-----
SS7
008-012-003 ----- no --- -----
-----
SS7
003-002-004 ----- no --- -----
-----
SS7
009-002-003 ----- no --- -----
-----
SS7
010-020-005 ----- no --- -----
-----
SS7

```

```

DPCI          CLLI          BEI ELEI  ALIASA
ALIASN/N24    DMN
1-207-0      ----- no --- -----
-----
SS7
0-015-0      ----- no --- -----
-----
SS7
0-017-0      ----- no --- -----
-----
SS7
1-011-1      ----- no --- -----
-----
SS7
1-011-2      ----- no --- -----
-----
SS7

```

```

Destination table is (14 of 2000) 1% full
Alias table is (0 of 12000) 0% full
PPC table is (1 of 20) 5% full

```

If the required point code is not shown in the `rtrv-dstn` output, perform the "Adding a Destination Point Code" procedure in *Database Administration - SS7 User's Guide* to add the required point code. A proxy point code cannot be assigned to the point code.

After the new point code has been added, perform one of the Adding a Route procedures in *Database Administration - SS7 User's Guide* and add the required route to the database. After the route has been added, continue the procedure with 6.

6. Display the point code that will be assigned to the global title translation by using the `rtrv-dstn` command and specifying the point code. For this example, enter this command.

```
rtrv-dstn:dPCA=010-020-005
```

This is an example of the possible output.

```
rlghncxa03w 10-12-10 11:43:04 GMT EAGLE5 43.0.0
```

```

DPCA          CLLI          BEI ELEI  ALIASI

```

```

ALIASN/N24   DMN
010-020-005 ----- no  --- -----
-----    SS7

      PPCA          NCAI PRX      RCAUSE NPRST SPLITIAM HMSMSC HMSCP
SCCPMSGCNV
009-002-003 ---- no       50      on    20       no      no      none

```

```

Destination table is (14 of 2000) 1% full
Alias table is (0 of 12000) 0% full
PPC table is (1 of 20) 5% full

```

If the point code is not shown in the `rtrv-dstn` command output, the following output is displayed.

```
rlghncxa03w 10-07-10 11:43:04 GMT EAGLE5 42.0.0
```

No destinations meeting the requested criteria were found

```

Destination table is (14 of 2000) 1% full
Alias table is (0 of 12000) 0% full
PPC table is (1 of 20) 5% full

```

A proxy point code (a point code value is shown in the `PPC` column) cannot be assigned to the point code. If a proxy point code is shown in this step, choose another point code from the `rtrv-dstn` output in [5](#) and repeat this step.

If the point code is not shown in the `rtrv-dstn` output, perform the “Adding a Destination Point Code” procedure in *Database Administration - SS7 User's Guide* and add the point code to the destination point code table.

- The point code specified with the `ent-gtt` command must be the DPC of a route, unless the point code is the EAGLE's point code. Enter the `rtrv-rte` command with the `dpc` parameter specifying the point code to be used with the `ent-gtt` command to verify whether or not the point code is the DPC of a route.

For this example, enter these commands.

```
rtrv-rte:dPCA=007-007-007
```

This is an example of the possible output.

```

rlghncxa03w 10-07-07 11:43:04 GMT EAGLE5 42.0.0
      DPCA          ALIASI          ALIASN/N24      LSN          RC          APCA
007-007-007 ----- -----
                                     ls03         10         007-007-007
                                     ls02         30         150-150-150
                                     lsa2         50         200-200-200
                                           RTX:No     CLLI=ls03clli

```

```
rtrv-rte:dPCA=003-003-003
```

This is an example of the possible output.

```

rlghncxa03w 10-07-07 11:43:04 GMT EAGLE5 42.0.0
      DPCA          ALIASI          ALIASN/N24      LSN          RC          APCA
003-003-003 ----- -----
                                     ls02         10         002-002-002

```

```
ls08      30    025-025-150
lsa5      50    066-030-100
RTX:No    CLLI=ls07c11i
```

If the point code is not shown in the `rtrv-rte` output, perform one of the Adding a Route procedures in *Database Administration - SS7 User's Guide* and add the required route to the database. After the route has been added, continue the procedure with [11](#).

- Enter the `rtrv-map` command with the point code and SSN value that will be specified for the GTT action entry.

For this example enter this command.

```
rtrv-map:pca=005-005-005:ssn=75
```

If the Flexible GTT Load Sharing feature is not enabled, this is an example of the possible output.

```
rlghncxa03w 09-07-25 09:42:31 GMT EAGLE5 41.1.0

PCA          Mate PCA          SSN RC MULT SRM MRC GRP NAME SSO
005-005-005          250 10 SOL *Y *Y GRP01     ON
```

MAP table is (37 of 1024) 4% full.

If the Flexible GTT Load Sharing feature is enabled, this is an example of the possible output.

```
rlghncxa03w 09-07-25 09:42:31 GMT EAGLE5 41.1.0

MAPSET ID=DFLT
PCA          Mate PCA          SSN RC MULT SRM MRC GRP NAME SSO
005-005-005          55  5  DOM YES YES ----- OFF
                   001-001-002  15 15  DOM YES YES ----- ON
                   001-001-003  25 20  DOM YES YES ----- ON
                   001-001-002  40 35  DOM YES YES ----- OFF

MAPSET ID=1
PCA          Mate PCA          SSN RC MULT SRM MRC GRP NAME SSO
005-005-005          50  5  DOM YES YES ----- OFF
                   001-001-002  10 15  DOM YES YES ----- ON
                   001-001-003  20 20  DOM YES YES ----- ON
                   001-001-002  40 35  DOM YES YES ----- OFF

MAPSET ID= 2
PCA          Mate PCA          SSN RC MULT SRM MRC GRP NAME SSO
005-005-005          5  10 SOL *Y *Y ----- OFF
```

MAP table is (12 of 36000) 1% full.

If the required MAP entry is shown in the `rtrv-map` output, continue the procedure with [11](#).

If the required MAP entry is not shown in the `rtrv-map` output, continue the procedure with [9](#).

9. Display the EAGLE self-identification, using the `rtrv-sid` command.

This is an example of the possible output.

```
rlghncxa03w 10-07-10 11:43:04 GMT EAGLE5 42.0.0

PCA                PCI                PCN                CLLI                PCTYPE
010-020-030        1-023-1            12-0-14-1         rlghncxa03w        OTHER
                   s-1-023-1         s-12-0-14-1

CPCA
002-002-002        002-002-003        002-002-004        002-002-005
002-002-006        002-002-007        002-002-008        002-002-009
004-002-001        004-003-003        050-060-070

CPCI
1-001-1            1-001-2            1-001-3            1-001-4
1-002-1            1-002-2            1-002-3            1-002-4
2-001-1            7-222-7

CPCN
2-0-10-3           2-0-11-0           2-0-11-2           2-0-12-1
2-2-3-3           2-2-4-0            10-14-10-1
```

If the point code that will be specified for the GTT action entry is not shown in this step as the EAGLE's point code, perform one of these procedures to provision the required MAP entry. After the required MAP entry has been provisioned, continue the procedure with **11**.

- [Provisioning a Solitary Mated Application](#)
- [Provisioning a Dominant Mated Application](#)
- [Provisioning a Load Shared Mated Application](#)
- [Provisioning a Combined Dominant/Load Shared Mated Application](#)

If the point code that will be specified for the GTT action entry is shown in this step as the EAGLE's point code, perform one of these procedures to provision the required MAP entry. After the required MAP entry has been provisioned, continue the procedure with **10**.

- [Provisioning a Solitary Mated Application](#)
- [Provisioning a Dominant Mated Application](#)

10. Enter the `rtrv-ss-appl` command to verify that either the LNP, EIR, V-Flex, ATINPQ, INP, or AIQ subsystem number (depending on which feature is on) is in the subsystem application table.

This is an example of the possible output.

```
rlghncxa03w 10-07-28 14:42:38 GMT EAGLE5 42.0.0
APPL      SSN      STAT
LNP       254      ONLINE

SS-APPL table is 20% FULL (1 of 5)
```

If the subsystem number is shown in the `rtrv-ss-appl` output, continue the procedure with [11](#).

If no subsystem number is shown in the `rtrv-ss-appl` output, or if the `rtrv-ss-appl` command is rejected, perform the procedures in one of these user's guides, depending on the type of subsystem you wish to use, to enable and turn on the feature as necessary, and add the subsystem to the subsystem application table.

- EIR subsystem – go to *EIR User's Guide*.
- INP subsystem – go to *INP/AINPQ User's Guide*.
- LNP subsystem – go to *ELAP Administration and LNP Feature Activation Guide*.
- V-Flex subsystem – go to *V-Flex User's Guide*.
- ATINPQ subsystem – go to *ATINP*.
- AIQ subsystem – go to *Analyzed Information Features User's Guide*.

11. Continue the procedure by performing one of these steps.

If the `loopset` parameter will be specified for the GTT action entry, continue the procedure with [12](#). If `LOOPSET` values are shown in the `rtrv-gttact` output and you wish to use one of these values for the GTT action entry, [12](#) does not need to be performed.

If the `loopset` parameter will not be specified for the GTT action entry, but the `cdgtmodid` or `cggtmodid` parameters will be specified for the GTT action entry, continue the procedure with [13](#). If `CDGTMODID` or `CGGTMODID` values are shown in the `rtrv-gttact` output and you wish to use one of these values for the GTT action entry, [13](#) does not need to be performed.

Continue the procedure with [14](#) if the GTT action entry will not contain these parameter values.

- If the `loopset`, `cdgtmodid`, and `cggtmodid` parameters will not be specified for the GTT action entry and the `act` value of the GTT action entry will be `dup`.
- If the `loopset`, `cdgtmodid`, `cggtmodid`, and the `defactid` parameters will not be specified for the GTT action entry and the `act` value of the GTT action entry will be `fwd`.

12. Display all the loopsets in the database by entering this command

```
rtrv-loopset:num=1000:force=yes
```

This is an example of the possible output.

LoopSet	Mode	Point Codes	
cary2	notify	005-015-005	007-007-007 (ANSI)
		033-004-003	033-007-003
		005-027-005	007-004-007
cary4	notify	005-012-005	007-026-007 (ANSI)
		003-049-003	033-002-003
		005-008-055	007-014-007
apex3	discard	005-017-008	007-017-009 (ANSI)
		033-005-043	005-014-005

		005-017-005	007-014-007
		033-002-043	005-038-005
		007-009-027	033-003-043
		005-012-005	007-002-027
apex4	discard	005-007-008	027-007-009 (ANSI)
		033-005-003	005-004-055
		027-001-007	033-008-003
		033-007-003	005-003-055
		027-008-007	
ral5	notify	005-005-005	007-007-007 (ANSI)
		003-004-003	003-001-003
		005-007-005	007-004-007
		003-002-003	005-008-005
		007-009-007	003-003-003
		005-002-005	007-002-007
ral6	notify	005-007-008	007-007-009 (ANSI)
		003-005-003	003-007-003
		005-007-005	
dunn1	discard	005-002-055	007-051-007 (ANSI)
		003-008-033	
rtp9	discard	005-002-005	007-001-007 (ANSI)
		003-008-003	003-007-003
		005-003-005	007-008-007
		005-004-005	
rtp5	discard	005-007-008	007-007-009 (ANSI)
		003-005-003	
rtp1	discard	005-005-005	007-007-007 (ANSI)
		003-004-003	003-007-003
		005-007-005	007-004-007
		005-004-005	
rtp2	notify	005-007-008	007-007-009 (ANSI)
		003-005-003	

```
rlghncxa03w 09-05-28 21:15:37 GMT EAGLE5 41.0.0
LOOPSET table is (11 of 1000) 1% full
RTRV-LOOPSET: MASP A - COMPLTD
```

 **Note:**

If the `rtrv-loopset` command is entered with no other parameters specified, a maximum of 50 entries are displayed. To display more than 50 entries, the `force=yes` parameter must be specified with the `rtrv-loopset` command and the `num` parameter value must be greater than 50. Since there can be a maximum of 1000 loopsets in the database, to display all the loopsets in the database, the `force=yes` and `num = 1000` parameters must be specified with the `rtrv-loopset` command.

If the required loopset is not shown in the `rtrv-loopset` output, perform the [Adding a Loopset](#) procedure to add the required loopset.

If the required loopset is shown in the `rtrv-loopset` output, or if the [Adding a Loopset](#) procedure was performed and the `cdgtmodid` or `cggtmodid`

parameters will be specified for the GTT action entry, continue the procedure with [13](#).

If CDGTMODID or CGGTMODID values are shown in the `rtrv-gttact` output and you wish to use one of these values for the GTT action entry, [13](#) does not need to be performed. Continue the procedure with [14](#).

 **Note:**

If an ANSI point code will be assigned to the GTT action entry, the `NGTI` value in the GT modification entry must be 2.

- 13.** Display the GT modification information in the database using the `rtrv-gtmod` command.

This is an example of the possible output.

```
rlghncxa03w 10-07-07 00:29:31 GMT EAGLE5 42.0.0

GTMODID   NTT   NGTI  GT0FILL  NNP   NNAI  NPDD  NSDD  PRECD  CGPASSN
modid2    --    2     ON       --    --    --    --    PFX    --
NPDS=
modid5    --    2     OFF      --    --    --    --    PFX    --
NPDS=
modid6    --    4     ON       4     5     3     3     SFX    --
NPDS=123
modid10   --    --    OFF      5     5     --    --    PFX    --
NPDS=
modid11   --    --    OFF      5     5     --    --    PFX    --
NPDS=
```

GTMOD table is (5 of 100000) 1% full.

If the desired GT modification entry is not displayed, perform the [Adding Global Title Modification Information](#) procedure to add the desired GT modification entry to the database.

If the desired GT modification entry is displayed or the [Adding Global Title Modification Information](#) procedure was performed, continue the procedure with [14](#).

 **Note:**

If an ANSI point code will be assigned to the GTT action entry, the `NGTI` value in the GT modification entry must be 2.

- 14.** Add the GTT action entry to the database using the `ent-gttact` command.

[Table 4-51](#) shows the parameter combinations that can be used with the `ent-gttact` command.

Table 4-51 GTT Actions Parameter Combinations

ACT Value DISC	ACT Value UDTS	ACT Value TCAPERR	ACT Value DUP	ACT Value FWD
Mandatory Parameters				
actid	actid	actid	actid pc/pca/pci/ pcn/pcn24 ri=gt, ssn	actid pc/pca/pci/ pcn/pcn24 ri=gt, ssn
Optional Parameters				
on=uimreqd (See Note 1)	on=uimreqd (See Note 1)	on=uimreqd (See Note 1)	ssn=2 - 255 (See Note 3)	ssn=2 - 255 (See Note 3)
off=uimreqd (See Note 1)	off=uimreqd (See Note 1)	off=uimreqd (See Note 1)	mrnset	mrnset
	udtserr	atcaperr itcaperr	mapset cgpc/cgpca/ cgpci/ cgpcn/cgpcn24 loopset on=useicmsg (See Note 2) off=useicmsg (See Note 2) cgpogmsg cdgtmodid cggmodid	mapset cgpc/cgpca/ cgpci/ cgpcn/cgpcn24 loopset on=useicmsg (See Note 2) off=useicmsg (See Note 2) cgpogmsg cdgtmodid cggmodid defactid

Table 4-51 (Cont.) GTT Actions Parameter Combinations

ACT Value DISC	ACT Value UDTS	ACT Value TCAPERR	ACT Value DUP	ACT Value FWD
Parameter Values:				
actid = the name of the GTT action entry consisting of one alphabetic character and up to eight alphanumeric characters. The actid value cannot be the words none or fallback.				
udtserr = 0 to 255. The default value is 7.				
atcaperr = 0 to 255. The default value is 0.				
itcaperr = 0 to 255. The default value is 0.				
pc/pca/pci/pcn/pcn24 - one of these types of point codes.				
<ul style="list-style-type: none"> • pc/pca = ANSI point code • pci = ITU-I or ITU-I spare point code • pcn = 14-bit ITU-N or 14-bit ITU-N spare point code • pcn24 = 24-bit ITU-N point code. 				
mrnset - the MRN set ID from the rtrv-mrn output, or the value none. This parameter must be specified if the Flexible GTT Load Sharing feature is enabled and the ri value is gt. This parameter cannot be specified if the Flexible GTT Load Sharing feature is not enabled.				
mapset - the MAP set ID from the rtrv-map output. This parameter must be specified if the Flexible GTT Load Sharing feature is enabled and the ri value is ssn. This parameter cannot be specified if the Flexible GTT Load Sharing feature is not enabled.				
cgpc/cgpca/cgpci/cgpcn/cgpcn24 - the calling party point code. The network type of this parameter and the pc/pca/pci/pcn/pcn24 parameter must be the same.				
<ul style="list-style-type: none"> • cgpc/cgpca = ANSI point code • cgpci = ITU-I or ITU-I spare point code • cgpcn = 14-bit ITU-N or 14-bit ITU-N spare point code • cgpcn24 = 24-bit ITU-N point code. 				
loopset - the loopset name from the rtrv-loopset output.				
cgopgmsg - one of these values.				
<ul style="list-style-type: none"> • dflt - Default. The standard global title translation process supplies the calling party point code. This is the default value for the cgopgmsg parameter. • cgpcicmsg - the calling party point code from the incoming MSU is used as the calling party point code. • opcicmsg - The OPC from the incoming MSU is used as the calling party point code. • provcgpc - the value of the cgpc/cgpca/cgpci/cgpcn/cgpcn24 parameter specified in this procedure is used as the calling party point code. If this value is specified, the cgpc/cgpca/cgpci/cgpcn/cgpcn24 parameter must be specified. 				
cdgtmodid - The called party global title modification identifier from the rtrv-gtmod output.				
cggmodid - The calling party global title modification identifier from the rtrv-gtmod output.				
defactid - one of these values.				
<ul style="list-style-type: none"> • The GTT action ID whose act value is disc, udts, or tcaperr. If the required GTT action entry is not shown in the rtrv-gttact output, perform this procedure to add the required GTT action entry before this value is specified. • fallback - The message is routed using the routing data in the incoming MSU. This is the default value for the defactid parameter. 				

Notes:

- a. If the on=uimreqd is specified, the off=uimreqd parameter cannot be specified. If the off=uimreqd is specified, the on=uimreqd parameter cannot be specified.

Table 4-51 (Cont.) GTT Actions Parameter Combinations

ACT Value DISC	ACT Value UDTS	ACT Value TCAPERR	ACT Value DUP	ACT Value FWD
<p>b. If the <code>on=useicmsg</code> is specified, the <code>off=useicmsg</code> parameter cannot be specified. If the <code>off=useicmsg</code> is specified, the <code>on=useicmsg</code> parameter cannot be specified.</p>				
<p>c. if the <code>ri</code> parameter value is <code>ssn</code>, the <code>ssn</code> parameter must be specified.</p>				

For this example, enter these commands.

```
ent-gttact:actid=action11:act=disc:on=uimreqd
ent-gttact:actid=action15:act=udts
ent-gttact:actid=action17:act=tcaperr:atcaperr=10:itcaperr=20
ent-gttact:actid=action20:act=dup:pc=2-2-2:ri=gt:mrnset=dflt
ent-
gttact:actid=action21:act=dup:pc=2-2-2:ri=ssn:mapset=dflt:ssn
=50
ent-
gttact:actid=action22:act=fwd:pc=2-2-2:ri=ssn:mapset=dflt:ssn
=50
ent-gttact:actid=action23:act=fwd:pc=2-2-2:ri=gt:mrnset=dflt
```

When each of these commands have successfully completed, this message should appear.

```
rlghncxa03w 10-07-21 00:29:31 GMT EAGLE5 42.0.0
```

```
GTT-ACT table is (14 of 2000) 1% full.
```

```
ENT-GTTACT: MASP A - COMPLTD
```

- 15.** Verify the changes using the `rtrv-gttact` command with the `actid` parameter and value specified in [14](#).

For this example, enter these commands.

```
rtrv-gttact:actid=action11

rlghncxa03w 10-07-07 00:30:31 GMT EAGLE5 42.0.0

ACTID      ACTION    ATCAPERR  ITCAPERR  UDTSEERR  UIMREQD
-----
action11   disc      ---       ---       ---       on

GTT-ACT table is (14 of 2000) 1% full.
```

rtrv-gttact:actid=action15

rlghncxa03w 10-07-07 00:30:31 GMT EAGLE5 42.0.0

ACTID	ACTION	ATCAPERR	ITCAPERR	UDTSERR	UIMREQD
action15	udts	---	---	7	off

GTT-ACT table is (14 of 2000) 1% full.

rtrv-gttact:actid=action17

rlghncxa03w 10-07-07 00:30:31 GMT EAGLE5 42.0.0

ACTID	ACTION	ATCAPERR	ITCAPERR	UDTSERR	UIMREQD
action17	tcaperr	10	20	---	off

GTT-ACT table is (14 of 2000) 1% full.

rtrv-gttact:actid=action20

rlghncxa03w 10-07-07 00:30:31 GMT EAGLE5 42.0.0

ACTID	ACTION	ATCAPERR	ITCAPERR	UDTSERR	UIMREQD

ACTID	ACTION	PCA	RI	SSN	MRNSET	MAPSET

 action20 dup 002-002-002 gt --- DFLT -----
 CDGTMODID = ----- CGGTMODID = -----
 LOOPSET = None
 USEICMSG = off CGPCOGMSG = dflt CGPCA = ---

ACTID	ACTION	PCI	RI	SSN	MRNSET	MAPSET

ACTID	ACTION	PCN	RI	SSN	MRNSET	MAPSET

ACTID	ACTION	PCN24	RI	SSN	MRNSET	MAPSET

GTT-ACT table is (14 of 2000) 1% full.

rtrv-gttact:actid=action21

rlghncxa03w 10-07-07 00:30:31 GMT EAGLE5 42.0.0

ACTID	ACTION	ATCAPERR	ITCAPERR	UDTSERR	UIMREQD

ACTID	ACTION	PCA	RI	SSN	MRNSET	MAPSET

action21	dup	002-002-002	ssn	50	----	DFLT
		CDGTMODID =	-----	CGGTMODID =	-----	
		LOOPSET =	None			
		USEICMSG =	off	CGPCOGMSG =	dflt	CGPCA =

ACTID	ACTION	PCI	RI	SSN	MRNSET	MAPSET

ACTID	ACTION	PCN	RI	SSN	MRNSET	MAPSET

ACTID	ACTION	PCN24	RI	SSN	MRNSET	MAPSET

GTT-ACT table is (15 of 2000) 1% full.

rtrv-gttact:actid=action22

rlghncxa03w 10-07-07 00:30:31 GMT EAGLE5 42.0.0

ACTID	ACTION	ATCAPERR	ITCAPERR	UDTSERR	UIMREQD

ACTID	ACTION	PCA	RI	SSN	MRNSET	MAPSET

action22	fwd	002-002-002	ssn	50	----	DFLT
		CDGTMODID =	-----	CGGTMODID =	-----	
		LOOPSET =	None	DEFACTID =	Fallback	
		USEICMSG =	off	CGPCOGMSG =	dflt	CGPCA =

```

ACTID      ACTION  PCI          RI  SSN  MRNSET  MAPSET
-----
---
```

```

ACTID      ACTION  PCN          RI  SSN  MRNSET  MAPSET
-----
---
```

```

ACTID      ACTION  PCN24       RI  SSN  MRNSET  MAPSET
-----
---
```

GTT-ACT table is (15 of 2000) 1% full.

rtrv-gttact:actid=action23

rlghncxa03w 10-07-07 00:30:31 GMT EAGLE5 42.0.0

```

ACTID      ACTION  ATCAPERR ITCAPERR UDTSERR UIMREQD
-----
```

```

ACTID      ACTION  PCA          RI  SSN  MRNSET  MAPSET
-----
---
action23  fwd      002-002-002  gt  ---  DFLT    -----
          CDGTMODID = -----  CGGTMODID = -----
          LOOPSET = None      DEFACTID = Fallback
          USEICMSG = off     CGPCOGMSG = dflt      CGPCA = ---
```

```

ACTID      ACTION  PCI          RI  SSN  MRNSET  MAPSET
-----
---
```

```

ACTID      ACTION  PCN          RI  SSN  MRNSET  MAPSET
-----
---
```

```

ACTID      ACTION  PCN24       RI  SSN  MRNSET  MAPSET
-----
---
```

GTT-ACT table is (15 of 2000) 1% full.

- Backup the new changes using the `chg-db:action=backup:dest=fixed` command. These messages should appear, the active Maintenance and Administration Subsystem Processor (MASP) appears first.

```

BACKUP (FIXED) : MASP A - Backup starts on active MASP.
BACKUP (FIXED) : MASP A - Backup on active MASP to fixed disk
complete.
BACKUP (FIXED) : MASP A - Backup starts on standby MASP.
BACKUP (FIXED) : MASP A - Backup on standby MASP to fixed disk
complete.
    
```

Figure 4-41 Add a GTT Action - Sheet 1 of 8

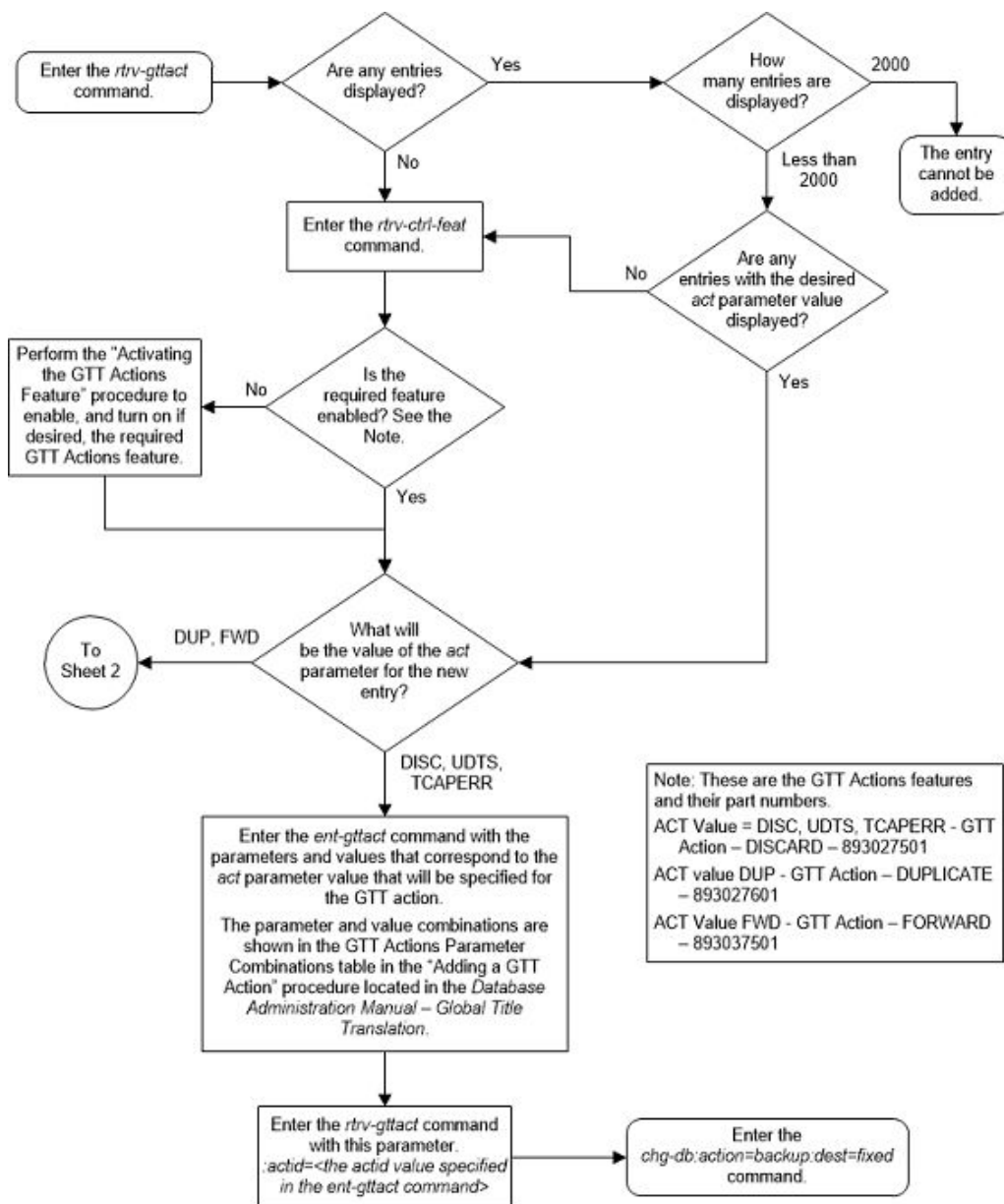

Figure 4-42 Add a GTT Action - Sheet 2 of 8

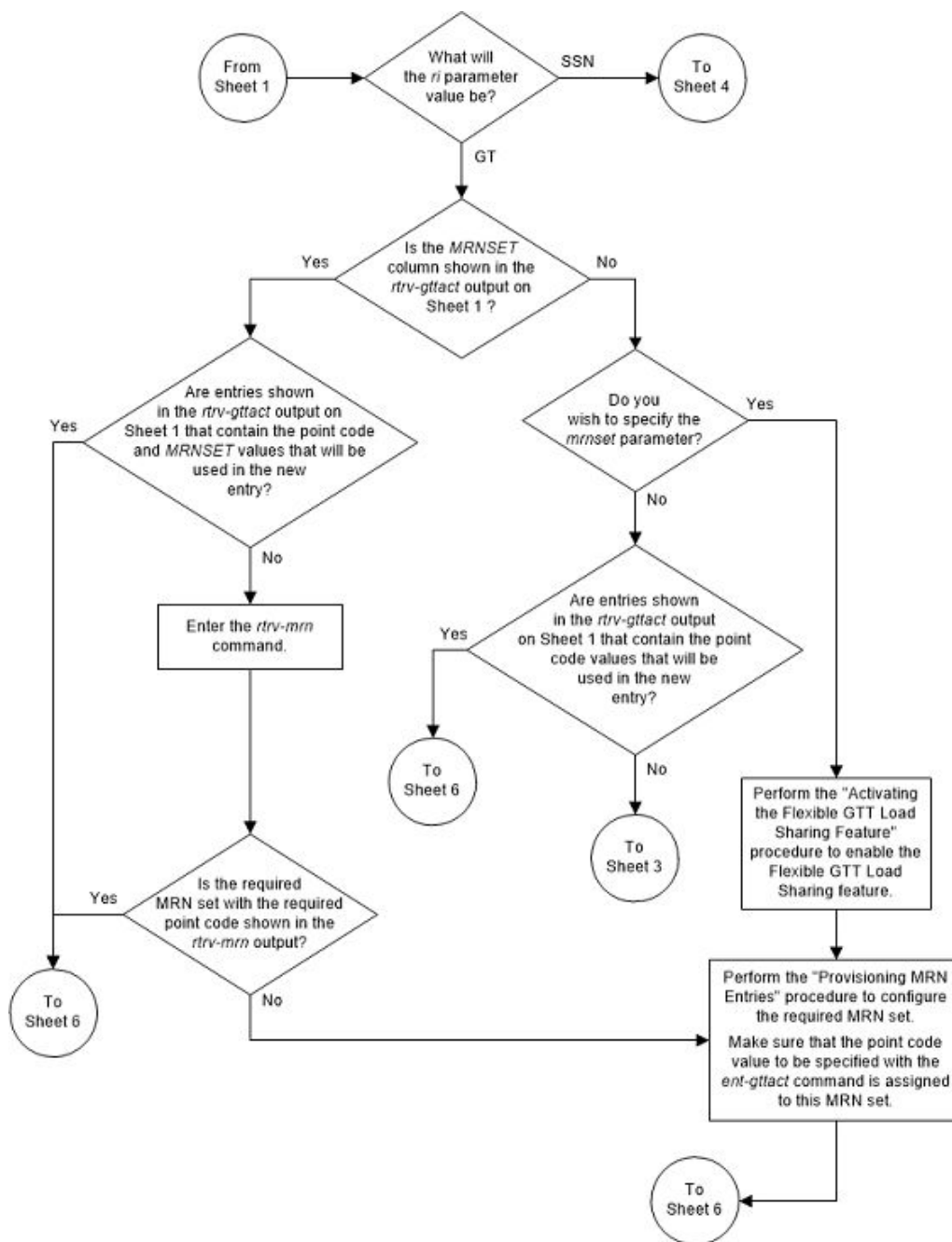

Figure 4-43 Add a GTT Action - Sheet 3 of 8

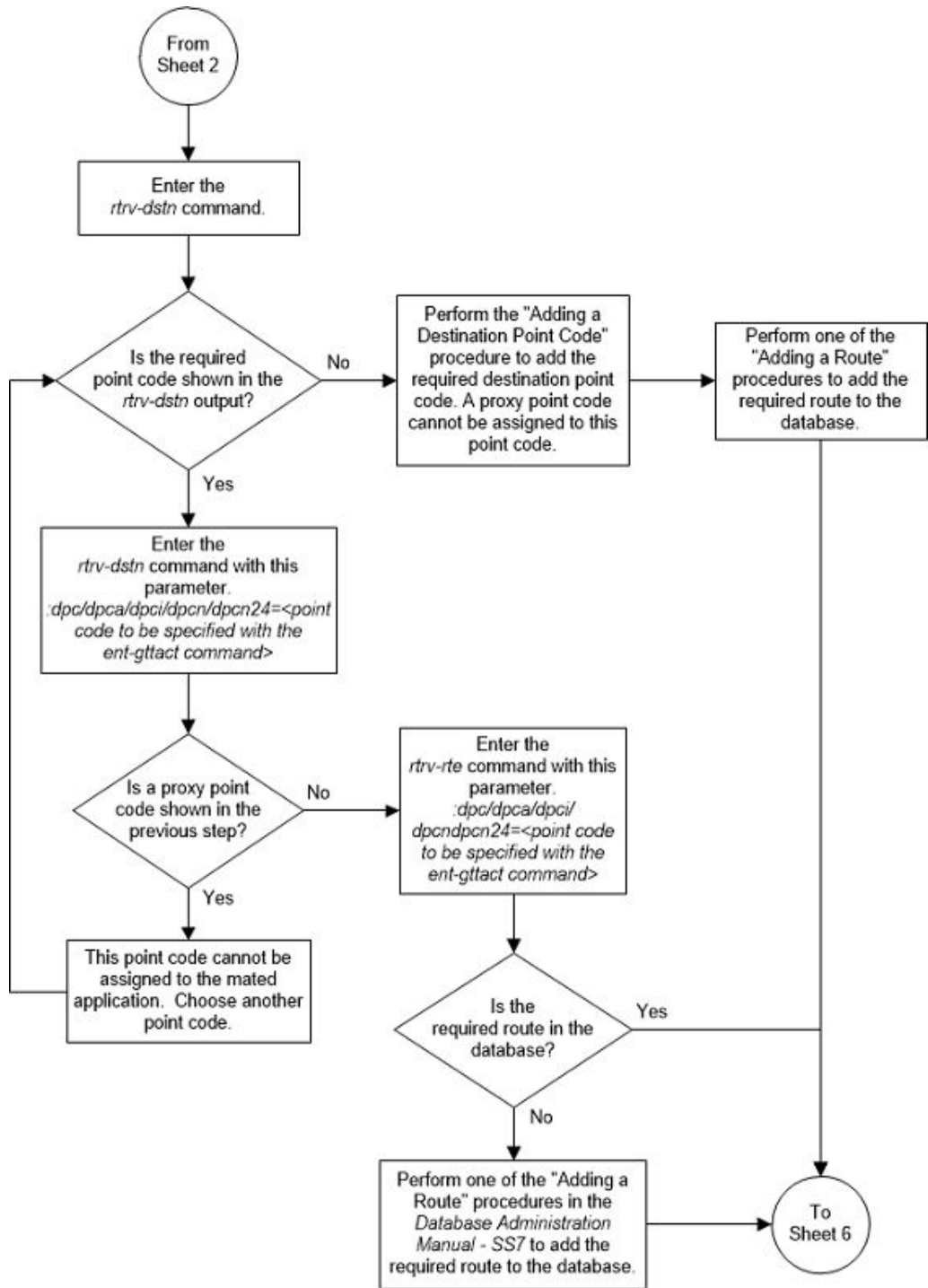

Figure 4-44 Add a GTT Action - Sheet 4 of 8

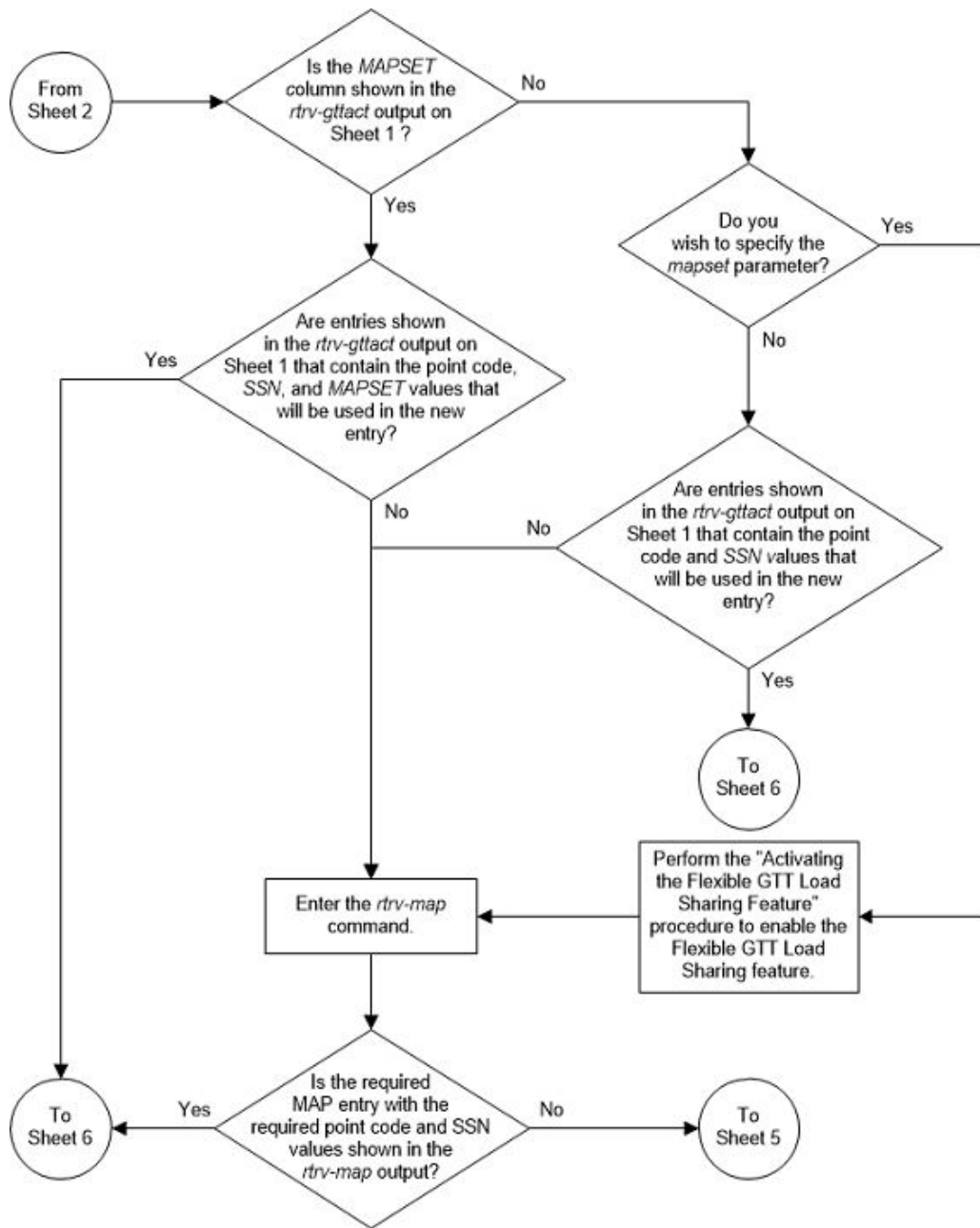

Figure 4-45 Add a GTT Action - Sheet 5 of 8

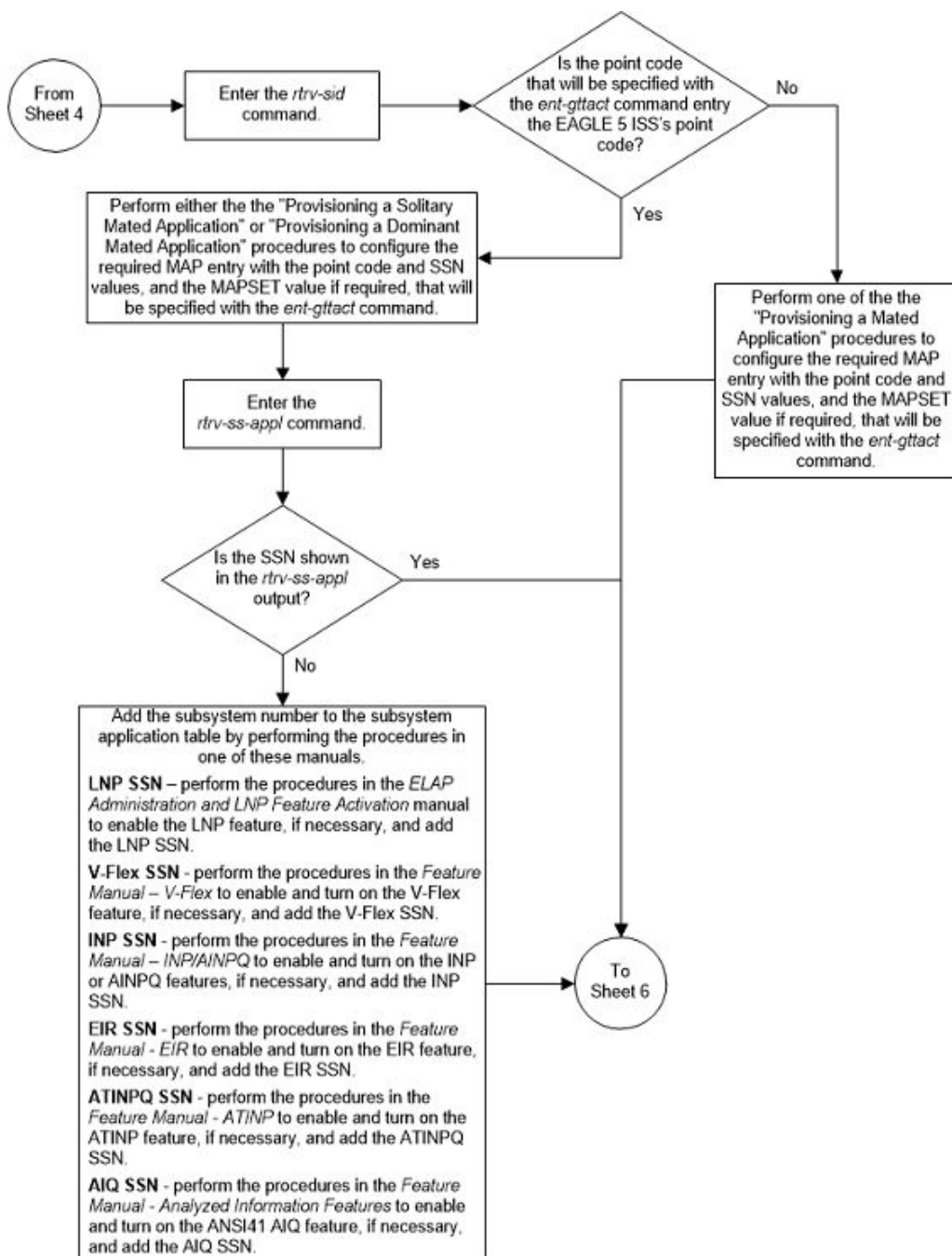

Figure 4-46 Add a GTT Action - Sheet 6 of 8

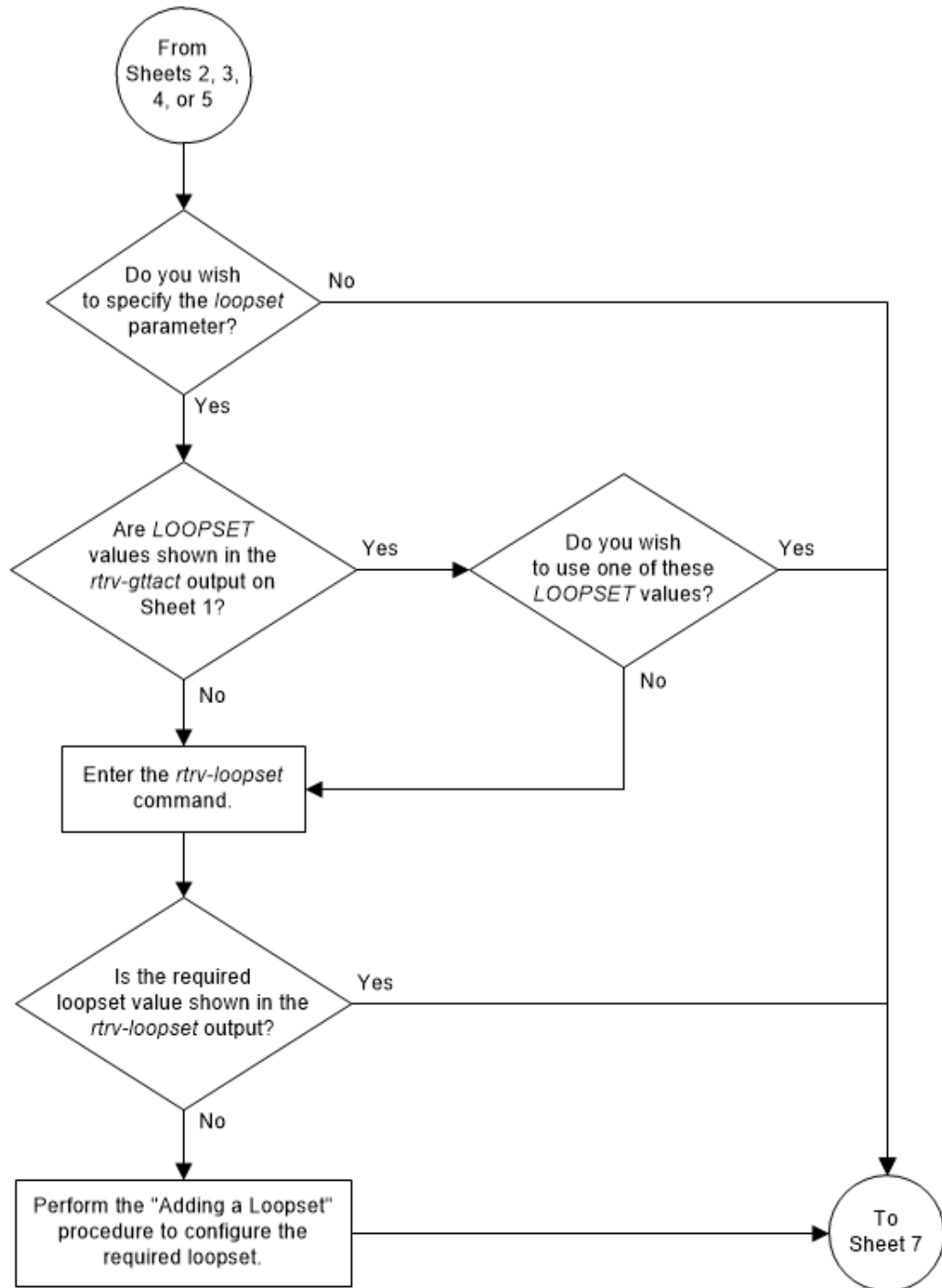

Figure 4-47 Add a GTT Action - Sheet 7 of 8

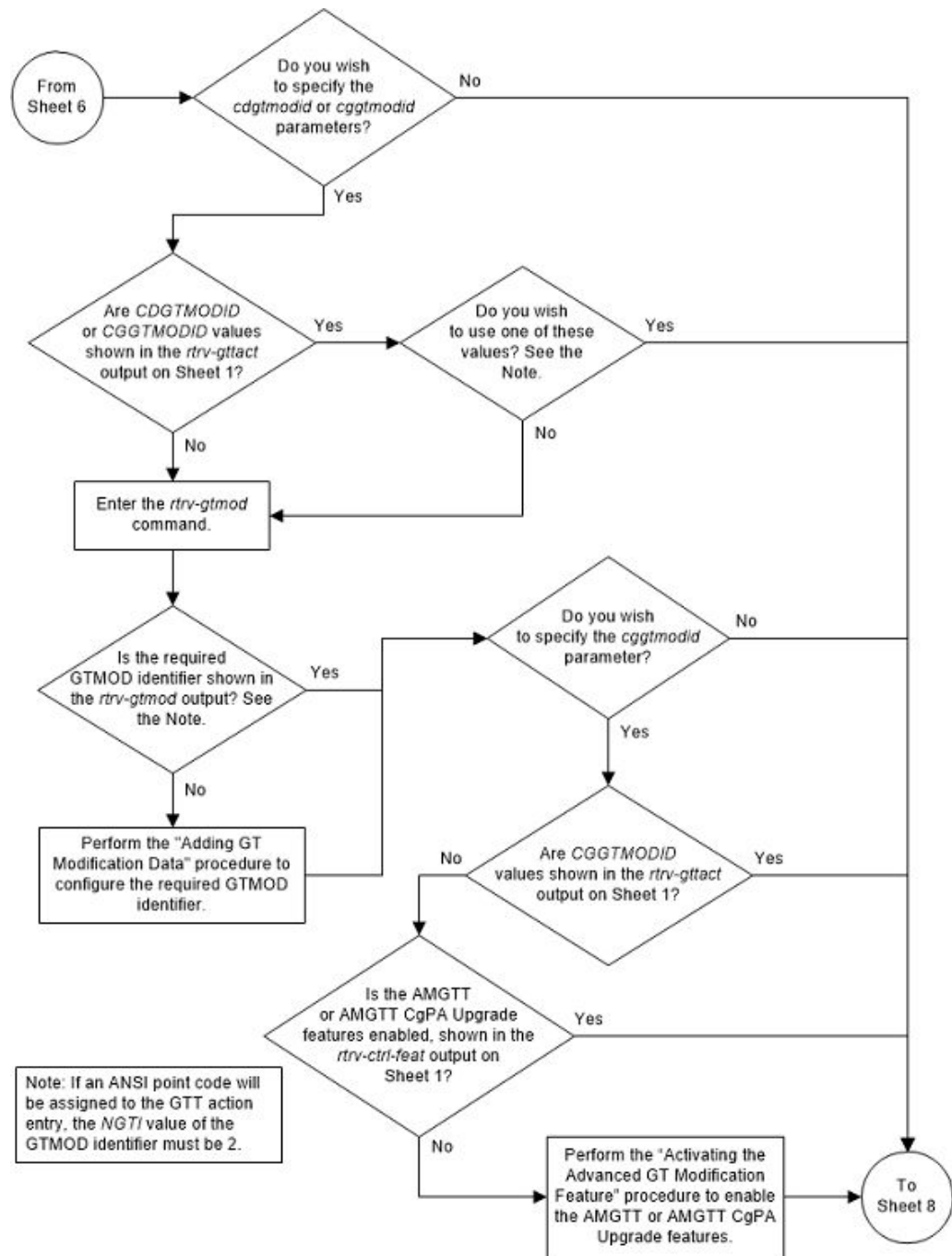
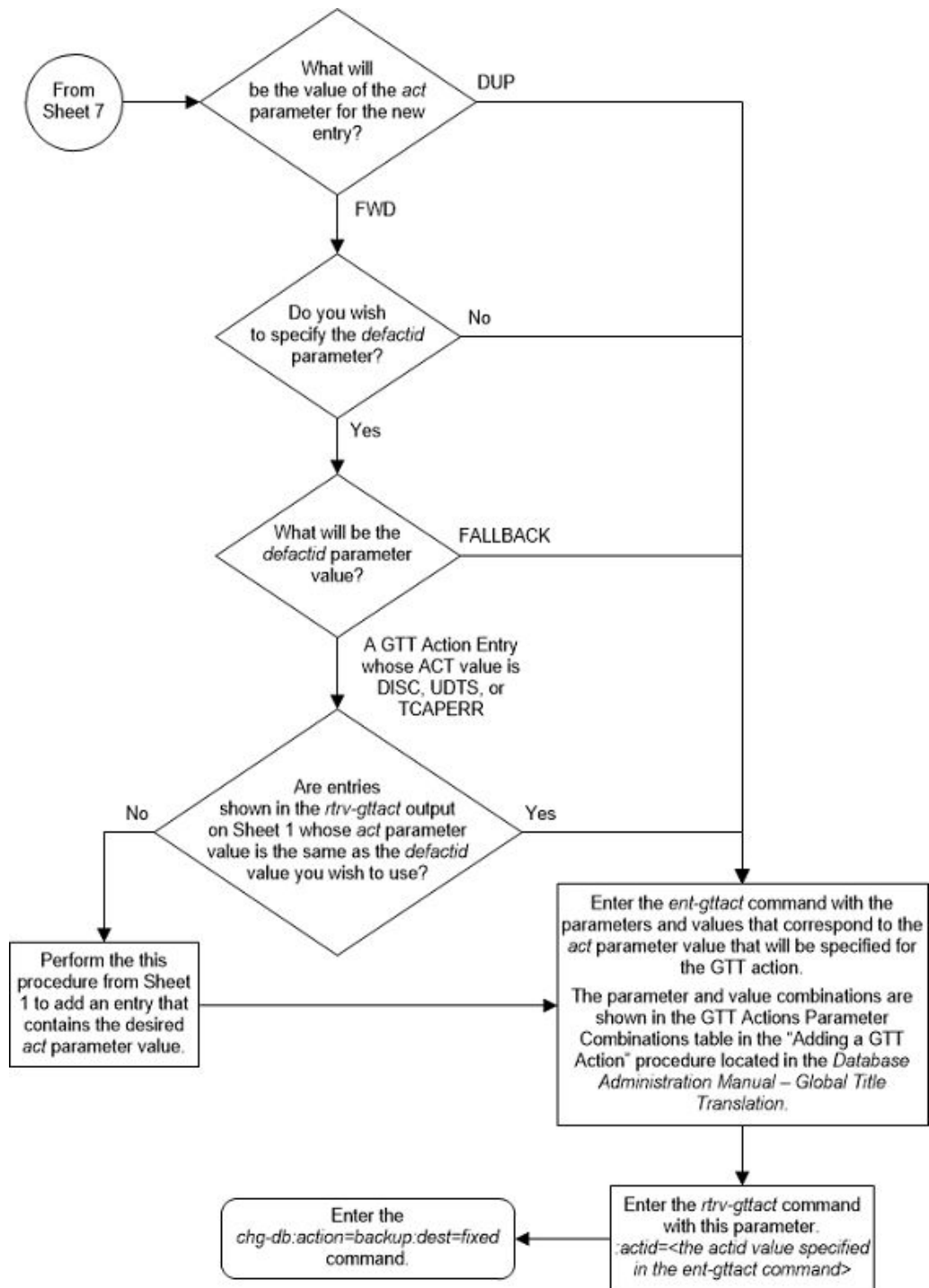

Figure 4-48 Add a GTT Action - Sheet 8 of 8



Removing a GTT Action

Use this procedure to remove a GTT action entry from the database using the `dlr-gttact` command.

The `dlt-gttset` command uses this parameter.

`:actid` – The GTT action identifier shown in the `rtrv-gttact` output.

The GTT action entry cannot be removed if it is assigned to a GTT action set. The `rtrv-gttaset` command output shows the GTT action sets.

The GTT action entry cannot be removed if it is referenced by one or more of these database entities.

- A forward GTT action that references a discard, UDTS, or TCAPERR GTT action. The GTT action that is being removed is shown in the `DEFACTID` column in the `rtrv-gttact` output.
- A GTT action set. The GTT action sets are shown in the `rtrv-gttaset` output.
- An LNP service. LNP services are shown in the `rtrv-lnp-serv` output.

1. Display the existing GTT action entries in the database by entering this command.

```
rtrv-gttact:on=refcnt
```

This is an example of the possible output.

```
rlghncxa03w 10-07-07 00:27:31 GMT EAGLE5 42.0.0
```

```
ACTID      ACTION    ATCAPERR  ITCAPERR  UDTSEERR  UIMREQD  REFCNT
-----
action2    disc      ---       ---       ---       off       2
```

```
ACTID      ACTION    PCA        RI  SSN  MRNSET  MAPSET  REFCNT
-----
---
action1    dup      002-002-002  gt  ---  DFLT   -----  1
          CDGTMODID = -----  CGGTMODID = -----
          LOOPSET = None
          USEICMSG = off    CGPCOGMSG = dflt    CGPCA = ---
action3    dup      003-003-003  gt  ---  1      -----  0
          CDGTMODID = -----  CGGTMODID = -----
          LOOPSET = None
          USEICMSG = off    CGPCOGMSG = dflt    CGPCA = ---
```

```
ACTID      ACTION    PCI        RI  SSN  MRNSET  MAPSET  REFCNT
-----
---
```

```
ACTID      ACTION    PCN        RI  SSN  MRNSET  MAPSET  REFCNT
-----
---
```

```
ACTID      ACTION    PCN24      RI  SSN  MRNSET  MAPSET  REFCNT
-----
---
```

GTT-ACT table is (3 of 2000) 1% full.

If the number of entities that reference the GTT action entry, the reference count, that is being removed is 0 (zero), continue the procedure with [6](#). The reference count is shown in the `REFCNT` column in the `rtrv-gttact` output.

If the number of entities that reference the GTT action entry that is being removed is greater than 0 (zero), continue the procedure by performing one these steps.

- If the `ACTION` value of the GTT action entry is `DUP` or `FWD`, continue the procedure with [5](#).
 - If the `ACTION` value of the GTT action entry is `DISC`, `UDTS`, or `TCAPERR`, continue the procedure with [2](#).
 - If the `ACTION` value of the GTT action entry is `DISC`, `UDTS`, or `TCAPERR`, perform one of these steps
 - If the `rtrv-gttact` output contains entries whose `ACTION` value is `FWD` and whose `DEFACTID` value is the `ACTION` value of the GTT action entry that is being removed, perform the [Changing a GTT Action](#) procedure to change the `DEFACTID` value to another GTT action entry. Perform the [Changing a GTT Action](#) procedure for each entry whose `ACTION` value is `FWD` and whose `DEFACTID` value is the `ACTION` value of the GTT action entry that is being removed. If all references to the GTT action entry have been removed, continue the procedure with [6](#).
 - If all references to the GTT action entry have not been removed, or there are no entries whose `ACTION` value is `FWD` and whose `DEFACTID` value is the `ACTION` value of the GTT action entry that is being removed, continue the procedure with [5](#).
 - If the `ACTION` value of the GTT action entry is `DUP` or `FWD`, continue the procedure with [5](#).
2. If the `rtrv-gttact` output contains entries whose `ACTION` value is `FWD` and whose `DEFACTID` value is the `ACTION` value of the GTT action entry that is being removed, perform the [Changing a GTT Action](#) procedure to change the `DEFACTID` value to another GTT action entry.

Perform the [Changing a GTT Action](#) procedure for each entry whose `ACTION` value is `FWD` and whose `DEFACTID` value is the `ACTION` value of the GTT action entry that is being removed. If all references to the GTT action entry have been removed, continue the procedure with [6](#).

Continue the procedure with [3](#):

- If all the references to the GTT action have not been removed.
 - If no entries are shown in the `rtrv-gttact` output whose `ACTION` value is `FWD`.
 - If entries are shown in the `rtrv-gttact` output whose `ACTION` value is `FWD`, but none of these entries reference the GTT action that is being removed.
3. Verify whether or not the LNP feature is enabled by entering the `rtrv-ctrl-feat` command.

This is an example of the possible output.

```
rlghncxa03w 10-12-28 21:15:37 GMT EAGLE5 43.0.0
The following features have been permanently enabled:
```

Feature Name	Partnum	Status	Quantity
Command Class Management	893005801	on	----
Intermed GTT Load Sharing	893006901	on	----
HC-MIM SLK Capacity	893012707	on	64

The following features have been temporarily enabled:

Feature Name	Partnum	Status	Quantity	Trial
Period Left				
Zero entries found.				

The following features have expired temporary keys:

Feature Name	Partnum
Zero entries found.	

If the LNP feature is enabled, the entry LNP ported TNs is shown in the `rtrv-ctrl-feat` output with a number shown in the `Quantity` column.

Continue the procedure with [5](#) if the LNP feature is not enabled.

Continue the procedure with [4](#) if the LNP feature is enabled.

4. Display the LNP services by entering the `rtrv-lnp-serv` command.

This is an example of the possible output.

```
rlghncxa03w 10-12-11 13:45:15 GMT EAGLE5 43.0.0
SERV TT TTN DV ALIAS GTTRQD SELID DFLTACT
CNAM 1 cnam1 SCCP --- On 10 fallback
      8 On 20 action2
LIDB 2 lidb1 SCCP --- Off None action2
      19 On None falltogtt
AIN 3 ain TCAP --- Off None fallback
UDF1 22 udf1 TCAP --- --- --- ---
```

LNP-SERV TABLE IS 2% FULL (6 of 256)

If entries are shown in the `rtrv-lnp-serv` output that reference the GTT action that is being removed, shown in the `DFLTACT` column, perform the "Changing an LNP Service" procedure in *ELAP Administration and LNP Feature Activation Guide* to change the `DFLTACT` value to another value. If all references to the GTT action entry have been removed after the "Changing an LNP Service" procedure has been performed, continue the procedure with [6](#).

Continue the procedure with [5](#):

- If all the references to the GTT action have not been removed after the "Changing an LNP Service" procedure has been performed.
- If no entries are shown in the `rtrv-lnp-serv` output that reference the GTT action that is being removed.

5. Display the GTT action sets that reference the GTT action entry that is being removed by entering the `rtrv-gttaset` command with the GTT action identifier the GTT action entry that is being removed.

For this example, enter this command.

```
rtrv-gttaset:actid1=action2
```

 **Note:**

There are six `actid` parameters that can be used with the `rtrv-gttaset` command: `actid1`, `actid2`, `actid3`, `actid4`, `actid5`, `actid6`. Any of these parameters can be used in this step.

This is an example of the possible output.

```
rlghncxa03w 10-07-07 00:28:31 GMT EAGLE5 42.0.0
```

```
ACTSN      TEST  ActIds
          MODE
-----
act2      off  action2 (DISC),-----,-----,
          -----,-----,-----
act3      off  action2 (DISC),-----,-----,
          -----,-----,-----
```

```
GTT-ASET table is (3 of 20000) 1% full.
```

Perform one of these procedures.

- [Removing a GTT Action Set](#) to remove the GTT action set that references the GTT action entry specified in this step.
- [Changing a GTT Action Set](#) to remove the GTT action entry specified in this step from the GTT action set.

Perform these procedures for each entry shown in this step.

6. Remove the GTT action entry from the database using the `dlt-gttact` command with the `ACTID` value of the GTT action entry that is being removed.

For this example, enter this command.

```
dlt-gttact:actid=action2
```

When the command has successfully completed, this message should appear:

```
rlghncxa03w 10-07-07 00:29:31 GMT EAGLE5 42.0.0
```

```
GTT-ACT table is (2 of 2000) 1% full
```

```
DLT-GTTACT: MASP A - COMPLTD
```

7. Verify the changes using the `rtrv-gttact` command with the `actid` parameter value specified in 6.

The following message is displayed.

```
E5071 Cmd Rej: GTT Action Id does not exist
```

8. Backup the new changes using the `chg-db:action=backup:dest=fixed` command.

These messages should appear, the active Maintenance and Administration Subsystem Processor (MASP) appears first.

```
BACKUP (FIXED) : MASP A - Backup starts on active MASP.  
BACKUP (FIXED) : MASP A - Backup on active MASP to fixed disk  
complete.  
BACKUP (FIXED) : MASP A - Backup starts on standby MASP.  
BACKUP (FIXED) : MASP A - Backup on standby MASP to fixed disk  
complete.
```

Figure 4-49 Remove a GTT Action Entry - Sheet 1 of 3

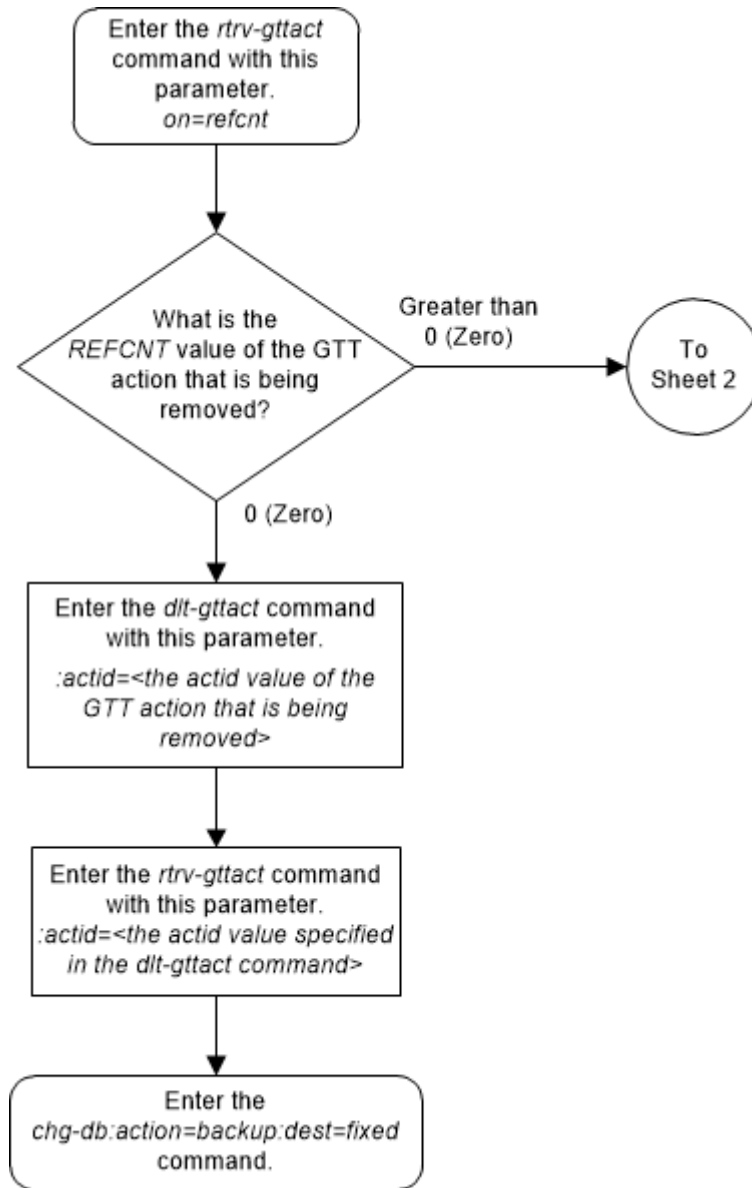

Figure 4-50 Remove a GTT Action Entry - Sheet 2 of 3

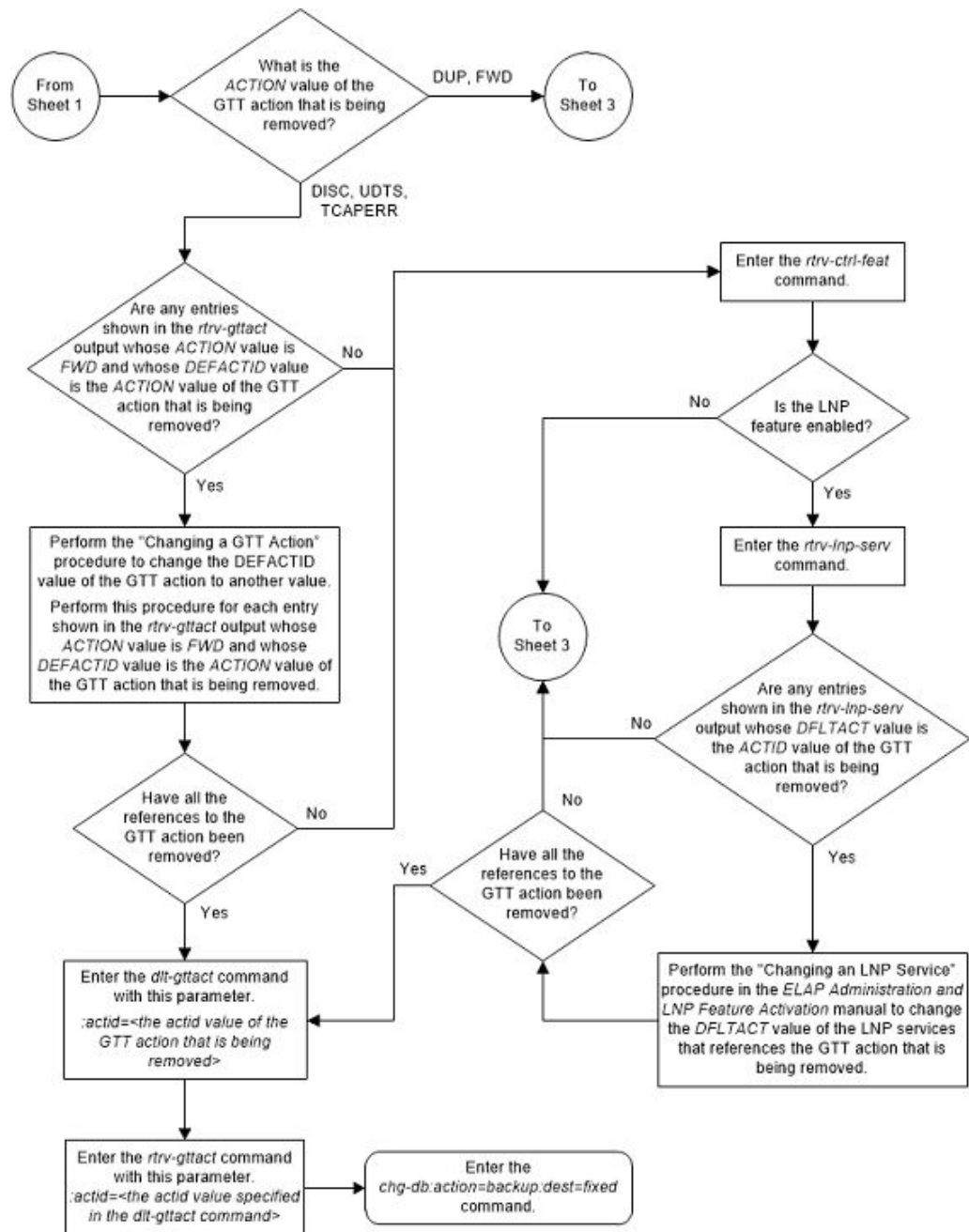
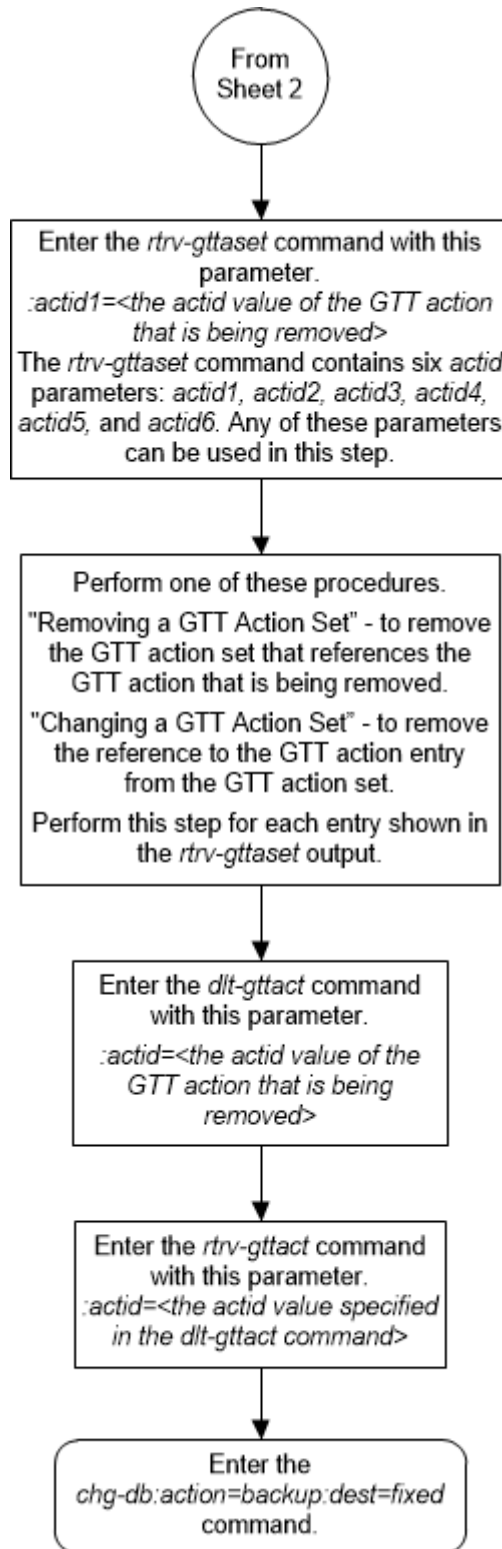

Figure 4-51 Remove a GTT Action Entry - Sheet 3 of 3



Changing a GTT Action

This procedure is used to change the attributes of a GTT action entry using the `chg-gttact` command.

The `chg-gttact` command uses these parameters.

`:act` - the action that is applied to the message. This parameter has these values.

- `disc` — discard the message with no return error.
- `dup` — route a copy of the message to the specified duplicate node.
- `tcaperr` — discard the message that has the specified TCAP error.
- `udts` — discard the message and send an UDTS/XUDTS.
- `fwd` — route the original message to the specified forward node instead of the destination indicated by the global title translation data.

`:actid` - the current name of the GTT action entry.

`:nactid` - the new name of the GTT action entry.

`:atcaperr` - the ANSI TCAP error cause - the reason for discarding the message containing the ANSI TCAP portion that is associated with the TCAP error GTT action.

`:cdgtmodid` - the name of the GT modification identifier that is associated with the called party of a GTT action entry.

`:cggtmodid` - the name of the GT modification identifier that is associated with the calling party of a GTT action entry.

`:cgpc/cgpc/cgpci/cgpcn/cgpcn24` - the calling party point code.

 **Note:**

See Chapter 2, "Configuring Destination Tables," in *Database Administration - SS7 User's Guide* for a definition of the point code types that are used on the EAGLE and for a definition of the different formats that can be used for ITU national point codes.

`:cgpcogmsg` - the data that is used as the calling party point code in the outgoing message.

`:defactid` - the default GTT action ID that is associated with the forward GTT action.

`:itcaperr` - the ITU TCAP error cause - the reason for discarding the message containing the ITU TCAP portion that is associated with the TCAP error GTT action.

`:loopset` - the name of the SCCP loopset name that is associated with the GTT action.

`:mapset` - the MAP set ID.

`:mrnset` - the MRN set ID.

`:off` - turns off the specified feature options.

- `:off=uimreqd` - a UIM is not generated.
- `:off=useicmsg` - apply the GTT action data to the message as the message was received.

`:on` - turns on the specified feature options.

- `:on=uimreqd` - a UIM is generated.
- `:on=useicmsg` - apply the GTT action data to the message after any EPAP or GTT translation/modification data has been applied.

`:pc/pca/pci/pcn/pcn24` - the point code that the message will be routed to as a result of the duplicate or forward GTT action.



Note:

See Chapter 2, "Configuring Destination Tables," in *Database Administration - SS7 User's Guide* for a definition of the point code types that are used on the EAGLE and for a definition of the different formats that can be used for ITU national point codes.

`:ri` - the routing indicator in the SCCP called party address of the duplicated copy of MSU.

`:ssn` - the subsystem number (SSN) in the SCCP called party address of the MSU.

`:udtserr` - the reason associated with the UDTs GTT action for discarding the message.

The values for the `actid`, `nactid`, `atcaperr`, `itcaperr`, `udtserr`, `pc/pca/pci/pcn/pcn24`, `ri`, `mrnset`, `mapset`, `ssn`, `loopset`, `cggmodid`, `cdgtmodid`, `defactid`, and `cgpc/cgpcac/cgpci/cgpcn/cgpcn24` parameters are shown in [Table 4-51](#).

One of these features must be enabled depending on the `act` parameter value that will be specified with the GTT action.

- `act=disc`, `act=udts`, `act=tcaperr` - GTT Action - DISCARD feature - part number 893027501.
- `act=dup` - GTT Action - DUPLICATE feature - part number 893027601.
- `act=fwd` - GTT Action - FORWARD feature - part number 893037501.

The status of these features is shown in the `rtrv-ctrl-feat` output. Perform the [Activating the GTT Actions Features](#) procedure to enable one or more of these features.

1. Display the existing GTT action entries in the database by entering this command.

```
rtrv-gttact:on=refcnt
```

This is an example of the possible output.

```
rlghncxa03w 10-07-07 00:27:31 GMT EAGLE5 42.0.0
```

```
ACTID      ACTION    ATCAPERR  ITCAPERR  UDTSEERR  UIMREQD  REFCNT
```

```
-----
action2  disc    ---    ---    ---    off    2
action10 disc    ---    ---    ---    off    3
action11 disc    ---    ---    ---    on     1
action15 udts    ---    ---    7     off    0
action16 tcaperr 0      0      ---    off    5
action17 tcaperr 10     20     ---    off    7
```

```
ACTID      ACTION      PCA          RI  SSN  MRNSET  MAPSET  REFCNT
-----
```

```
---
action1  dup      002-002-002  gt  ---  DFLT   -----  1
      CDGTMODID = -----  CGGTMODID = -----
      LOOPSET = None
      USEICMSG = off      CGPCOGMSG = dflt      CGPCA = ---
action3  dup      003-003-003  gt  ---  1     -----  0
      CDGTMODID = -----  CGGTMODID = -----
      LOOPSET = None
      USEICMSG = off      CGPCOGMSG = dflt      CGPCA = ---
action3  dup      002-002-002  gt  ---  DFLT   -----  2
      CDGTMODID = modid2    CGGTMODID = -----
      LOOPSET = None
      USEICMSG = off      CGPCOGMSG = dflt      CGPCA = ---
action4  dup      002-002-002  gt  ---  DFLT   -----  1
      CDGTMODID = -----  CGGTMODID = modid2
      LOOPSET = None
      USEICMSG = off      CGPCOGMSG = dflt      CGPCA = ---
action20 dup      002-002-002  gt  ---  DFLT   -----  1
      CDGTMODID = -----  CGGTMODID = -----
      LOOPSET = None
      USEICMSG = off      CGPCOGMSG = dflt      CGPCA = ---
action21 dup      002-002-002  ssn 50  ----  DFLT   1
      CDGTMODID = -----  CGGTMODID = -----
      LOOPSET = None
      USEICMSG = off      CGPCOGMSG = dflt      CGPCA = ---
action22 fwd      002-002-002  ssn 50  ----  DFLT   1
      CDGTMODID = -----  CGGTMODID = -----
      LOOPSET = None      DEFACTID = Fallback
      USEICMSG = off      CGPCOGMSG = dflt      CGPCA = ---
action23 fwd      002-002-002  gt  ---  DFLT   -----  1
      CDGTMODID = -----  CGGTMODID = -----
      LOOPSET = None      DEFACTID = Fallback
      USEICMSG = off      CGPCOGMSG = dflt      CGPCA = ---
action24 fwd      002-002-002  gt  ---  NONE   -----
      CDGTMODID = -----  CGGTMODID = -----
      LOOPSET = None      DEFACTID = Fallback
      USEICMSG = off      CGPCOGMSG = dflt      CGPCA = ---
action25 fwd      002-002-002  gt  ---  NONE   -----  1
      CDGTMODID = -----  CGGTMODID = -----
      LOOPSET = None      DEFACTID = action10
      USEICMSG = off      CGPCOGMSG = dflt      CGPCA = ---
```

```
ACTID      ACTION      PCI          RI  SSN  MRNSET  MAPSET  REFCNT
```

```
-----
---
ACTID      ACTION      PCN          RI  SSN  MRNSET  MAPSET  REFCNT
-----
---
```

```
ACTID      ACTION      PCN24       RI  SSN  MRNSET  MAPSET  REFCNT
-----
---
```

```
GTT-ACT  table is (15 of 2000) 1% full.
```

If the number of entities that reference the GTT action entry, the reference count, that is being changed is 0 (zero), continue the procedure with 4. The reference count is shown in the `REFCNT` column in the `rtrv-gttact` output.

If the number of entities that reference the GTT action entry that is being removed is greater than 0 (zero), these actions cannot be performed in this procedure continue the procedure by performing one these steps.

- The current `actid` value cannot be changed. If you wish to change the current `actid` value,
- The current `act` value cannot be changed unless the current `act` value is either `disc`, `udts`, or `tcaperr`, and the new `act` value will be either `disc`, `udts`, or `tcaperr`.

If you wish to change the current `actid` value or the current `act` value, continue the procedure by performing one of these steps.

- If the current `act` value is `dup` or `fwd`, continue the procedure with 3.
 - If the current `act` value is `disc`, `udts`, or `tcaperr`, continue the procedure by performing one of these steps.
 - If the `actid` value of the GTT action entry that is being changed is not shown as the `defactid` value of another GTT action entry, an entry whose `act` value is `fwd`, continue the procedure with 3.
 - If the `actid` value of the GTT action entry that is being changed is shown as the `defactid` value of another GTT action entry, an entry whose `act` value is `fwd`, continue the procedure with 2.
2. Enter the `chg-gttact` command with the `actid` and `defactid` parameters to change the `defactid` value of the GTT action entry to a value that is not the current `defactid` value.

For this example, enter this command.

```
chg-gttact:actid=action25:defactid=fallback
```

When this command has successfully completed, this message should appear.

```
rlghncxa03w 10-07-07 00:27:31 GMT EAGLE5 42.0.0
```

```
GTT-ACT  table is (15 of 2000) 1% full.
```

CHG-GTTACT: MASP A - COMPLTD

Perform this step for each entry shown in the `rtrv-gttact` output whose `act` value is `fwd` and whose `defactid` value is the `actid` value of the GTT action entry that is being changed.

If all the references to the GTT action entry that is being changed have been removed, continue the procedure with [4](#).

If all the references to the GTT action entry that is being changed have not been removed, continue the procedure with [3](#).

3. Display the GTT action sets that contain the GTT action entry that is being changed by entering the `rtrv-gttact` command with the name of the GTT action entry.

For this example, enter these commands.

```
rtrv-gttact:actid1=action10
```

The following is an example of the possible output.

```
rlghncxa03w 10-07-28 21:15:37 GMT EAGLE5 42.0.0
```

```
ACTSN      TEST  ActIds
          MODE
-----
act11      off  action10 (UDTS),-----,-----,
          -----,-----,-----
```

GTT-ASET table is (5 of 20000) 1% full.

```
rtrv-gttact:actid1=action1
```

The following is an example of the possible output.

```
rlghncxa03w 10-07-28 21:15:37 GMT EAGLE5 42.0.0
```

```
ACTSN      TEST  ActIds
          MODE
-----
act1       off  action1 (DUP),action4 (DUP),action25 (FWD),
          -----,-----,-----
act5       on   action1 (DUP),action3 (DUP),action4 (DUP),
          action20 (DUP),action21 (DUP),action17 (TCAPERR)
```

GTT-ASET table is (5 of 20000) 1% full.

Perform one of these procedures.

- [Removing a GTT Action Set](#) - to remove the GTT action set that references the GTT action entry that is being changed.
- [Changing a GTT Action Set](#) - to change the GTT action set to remove the references to the GTT action entry that is being changed.

Perform these procedures for each entry that is shown in the `rtrv-gttaset` output.

4. Continue the procedure by performing one of these steps.

If the `act` value of the GTT action entry will be `disc`, `udts`, or `tcaperr` when this procedure is finished, continue the procedure by performing one of these steps.

- If the current `act` value is `disc`, `udts`, or `tcaperr`, continue the procedure with 16.
- If the current `act` value is `dup` or `fwd`, continue the procedure by performing one of these steps.
 - If entries are shown in the `rtrv-gttact` output whose `act` values are `disc`, `udts`, or `tcaperr`, continue the procedure with 16.
 - If no entries are shown in the `rtrv-gttact` output whose `act` values are `disc`, `udts`, or `tcaperr`, perform the [Activating the GTT Actions Features](#) procedure to enable and turn on the GTT Action - DISCARD feature. After the [Activating the GTT Actions Features](#) procedure has been performed, continue the procedure with 16.

If the `act` value of the GTT action entry will be `dup` when this procedure is finished, continue the procedure by performing one of these steps.

- If the `rtrv-gttact` output contains no entries whose `act` value is `dup`, perform the [Activating the GTT Actions Features](#) procedure to enable and turn on the GTT Action - DUPLICATE feature.
- If the `rtrv-gttact` output contains entries whose `act` value is `dup`, or the [Activating the GTT Actions Features](#) procedure has been performed, continue the procedure 5.

If the `act` value of the GTT action entry will be `fwd` when this procedure is finished, continue the procedure by performing one of these steps.

- If the `rtrv-gttact` output contains no entries whose `act` value is `fwd`, perform the [Activating the GTT Actions Features](#) procedure to enable and turn on the GTT Action - FORWARD feature.
- If the `rtrv-gttact` output contains entries whose `act` value is `dup`, or the [Activating the GTT Actions Features](#) procedure has been performed, continue the procedure 5.

5. For GTT action entries whose `act` value will be either `dup` or `fwd`, the GTT action entry must contain a value for the `ri` parameter must be specified for the GTT action entry.

If the `ri` parameter value for the GTT action entry will be `gt`, the `pc/pca/pci/pcn/pcn24` parameter must be specified for the GTT action entry. The point code must be the DPC of a route and cannot contain a proxy point code.

If the `MRNSET` column is shown in the `rtrv-gttact` output, the Flexible GTT Load Sharing feature is enabled. If the Flexible GTT Load Sharing feature is enabled, the `mrnset` parameter must be specified for the GTT action entry. The point code that will be assigned to the GTT action entry must be in an MRN set. MRN sets are shown in the `rtrv-mrn` output.

If the `ri` parameter value for the GTT action entry will be `ssn`, the `pc/pca/pci/pcn/pcn24` and `ssn` parameters must be specified for the GTT action entry. The point code and `ssn` values must be in the `rtrv-map` output.

If the `MAPSET` column is shown in the `rtrv-gttact` output, the Flexible GTT Load Sharing feature is enabled. If the Flexible GTT Load Sharing feature is enabled, the `mapset` parameter must be specified for the GTT action entry. The point code and `ssn` values that will be assigned to the GTT action entry must be in a MAP set. MAP sets are shown in the `rtrv-map` output.

If the `ri` value for the GTT action entry will be `gt`, the `MRNSET` column is not shown in the `rtrv-gttact` output, the `mrnset` parameter will not be specified for the GTT action entry, and the point code value for the GTT action entry is not shown in the `rtrv-gttact` output, continue the procedure with 7.

If you wish to specify the `mrnset` parameter for the GTT action entry, perform these procedures to configure the MRNSET with the required MRNSET with the point code value: [Activating the Flexible GTT Load Sharing Feature](#) and [Provisioning MRN Entries](#). After these procedures have been performed, continue the procedure with 13.

If the `ri` value for the GTT action entry will be `gt`, the `MRNSET` column is shown in the `rtrv-gttact` output, and the point code and MRNSET values for the GTT action entry are not shown in the `rtrv-gttact` output, continue the procedure with 6.

If the `ri` value for the GTT action entry will be `ssn`, the `MAPSET` column is not shown in the `rtrv-gttact` output, the `mapset` parameter will not be specified for the GTT action entry, and the point code and SSN values for the GTT action entry is not shown in the `rtrv-gttact` output, continue the procedure with 10.

If you wish to specify the `mapset` parameter for the GTT action entry, perform the [Activating the Flexible GTT Load Sharing Feature](#) procedure to enable the Flexible GTT Load Sharing Feature. After this procedure has been performed, continue the procedure with 10.

If the `ri` value for the GTT action entry will be `ssn`, the `MAPSET` column is shown in the `rtrv-gttact` output, and the point code, SSN, and MAPSET values for the GTT action entry are not shown in the `rtrv-gttact` output, continue the procedure with 10.

Note:

If the entry that is being changed will have a calling party point code value when this procedure is finished, the network type of the point code and the calling party point code values must be the same. The calling party point code is provisioned with the `cgpc/cgpca/cgpci/cgpcn/cgpcn24` parameter and is shown in the `CGPCA/CGPCI/CGPCN/CGPCN24` fields in the `rtrv-gttact` output.

6. Display the MRN entries entering the `rtrv-mrn` command.

This is an example of the possible output.

```
rlghncxa03w 10-07-28 21:15:37 GMT EAGLE5 42.0.0
```

MRNSET	PC	RC
DFLT	002-002-002	1
	003-003-003	2

MRNSET	PC	RC
1	003-003-003	2
	004-004-004	3
	005-005-005	4

MRN table is (5 of 6000) 1% full.

If the required MRN set is shown in the `rtrv-mrn` output, continue the procedure with [13](#).

If the required MRN set is not shown in the `rtrv-mrn` output, perform the [Provisioning MRN Entries](#) procedure to provision the required MRN set. After the [Provisioning MRN Entries](#) procedure has been performed, continue the procedure with [13](#).

7. Display the destination point codes in the database by entering the `rtrv-dstn` command. This is an example of the possible output.

```
rlghncxa03w 10-12-10 11:43:04 GMT EAGLE5 43.0.0
Extended Processing Time may be Required
```

DPCA	CLLI	BEI	ELEI	ALIASI
ALIASN/N24	DMN			
001-207-000	-----	no	---	-----
-----	SS7			
001-001-001	-----	no	---	-----
-----	SS7			
001-001-002	-----	no	---	-----
-----	SS7			
001-005-000	-----	no	---	-----
-----	SS7			
001-007-000	-----	no	---	-----
-----	SS7			
008-012-003	-----	no	---	-----
-----	SS7			
003-002-004	-----	no	---	-----
-----	SS7			
009-002-003	-----	no	---	-----
-----	SS7			
010-020-005	-----	no	---	-----
-----	SS7			

DPCI	CLLI	BEI	ELEI	ALIASA
ALIASN/N24	DMN			
1-207-0	-----	no	---	-----
-----	SS7			
0-015-0	-----	no	---	-----
-----	SS7			
0-017-0	-----	no	---	-----
-----	SS7			
1-011-1	-----	no	---	-----
-----	SS7			
1-011-2	-----	no	---	-----
-----	SS7			

```
Destination table is (14 of 2000) 1% full
Alias table is (0 of 12000) 0% full
PPC table is (1 of 20) 5% full
```

If the required point code is not shown in the `rtrv-dstn` output, perform the "Adding a Destination Point Code" procedure in *Database Administration - SS7 User's Guide* to add the required point code. A proxy point code cannot be assigned to the point code.

After the new point code has been added, perform one of the Adding a Route procedures in the *Database Administration - SS7* and add the required route to the database. After the route has been added, continue the procedure with 8.

8. Display the point code that will be assigned to the global title translation by using the `rtrv-dstn` command and specifying the point code. For this example, enter this command.

```
rtrv-dstn:dPCA=010-020-005
```

This is an example of the possible output.

```
rlghncxa03w 10-12-10 11:43:04 GMT EAGLE5 43.0.0
```

DPCA	CLLI	BEI	ELEI	ALIASI
ALIASN/N24	DMN			
010-020-005	-----	no	---	-----
-----	SS7			

PPCA	NCAI	PRX	RCAUSE	NPRST	SPLITIAM	HMSMSC	HMSCP
SCCPMSGCNV							
009-002-003	----	no	50	on	20	no	no none

```
Destination table is (14 of 2000) 1% full
Alias table is (0 of 12000) 0% full
PPC table is (1 of 20) 5% full
```

If the point code is not shown in the `rtrv-dstn` command output, the following output is displayed.

```
rlghncxa03w 10-07-10 11:43:04 GMT EAGLE5 42.0.0
```

```
No destinations meeting the requested criteria were found
```

```
Destination table is (14 of 2000) 1% full
Alias table is (0 of 12000) 0% full
PPC table is (1 of 20) 5% full
```

A proxy point code (a point code value is shown in the `PPC` column) cannot be assigned to the point code. If a proxy point code is shown in this step, choose another point code from the `rtrv-dstn` output in 7 and repeat this step.

If the point code is not shown in the `rtrv-dstn` output, perform the "Adding a Destination Point Code" procedure in the *Database Administration - SS7* and add the point code to the destination point code table.

9. The point code specified with the `ent-gtt` command must be the DPC of a route, unless the point code is the EAGLE's point code. Enter the `rtrv-rte` command with the `dpc` parameter specifying the point code to be used with the `ent-gtt` command to verify whether or not the point code is the DPC of a route.

For this example, enter these commands.

```
rtrv-rte:dpc=007-007-007
```

This is an example of the possible output.

```
rlghncxa03w 10-07-07 11:43:04 GMT EAGLE5 42.0.0
  DPCA      ALIASI      ALIASN/N24    LSN          RC          APCA
007-007-007 -----
                                ls03         10          007-007-007
                                ls02         30          150-150-150
                                lsa2         50          200-200-200
                                RTX:No      CLLI=ls03clli
```

```
rtrv-rte:dpc=003-003-003
```

This is an example of the possible output.

```
rlghncxa03w 10-07-07 11:43:04 GMT EAGLE5 42.0.0
  DPCA      ALIASI      ALIASN/N24    LSN          RC          APCA
003-003-003 -----
                                ls02         10          002-002-002
                                ls08         30          025-025-150
                                lsa5         50          066-030-100
                                RTX:No      CLLI=ls07clli
```

If the point code is not shown in the `rtrv-rte` output, perform one of the Adding a Route procedures in *Database Administration - SS7 User's Guide* and add the required route to the database. After the route has been added, continue the procedure with [13](#).

10. Enter the `rtrv-map` command with the point code and SSN value that will be specified for the GTT action entry.

For this example enter this command.

```
rtrv-map:pca=005-005-005:ssn=75
```

If the Flexible GTT Load Sharing feature is not enabled, this is an example of the possible output.

```
rlghncxa03w 09-07-25 09:42:31 GMT EAGLE5 41.1.0
  PCA      Mate PCA      SSN RC MULT SRM MRC GRP NAME SSO
005-005-005
                                250 10 SOL *Y *Y GRP01 ON
```

MAP table is (37 of 1024) 4% full.

If the Flexible GTT Load Sharing feature is enabled, this is an example of the possible output.

```
rlghncxa03w 09-07-25 09:42:31 GMT EAGLE5 41.1.0
```

```

MAPSET ID=DFLT
PCA           Mate PCA           SSN RC MULT SRM MRC GRP NAME SSO
005-005-005           55  5  DOM YES YES ----- OFF
                   001-001-002   15 15  DOM YES YES ----- ON
                   001-001-003   25 20  DOM YES YES ----- ON
                   001-001-002   40 35  DOM YES YES ----- OFF

```

```

MAPSET ID=1
PCA           Mate PCA           SSN RC MULT SRM MRC GRP NAME SSO
005-005-005           50  5  DOM YES YES ----- OFF
                   001-001-002   10 15  DOM YES YES ----- ON
                   001-001-003   20 20  DOM YES YES ----- ON
                   001-001-002   40 35  DOM YES YES ----- OFF

```

```

MAPSET ID=      2
005-005-005           5 10  SOL *Y *Y ----- OFF

```

MAP table is (12 of 36000) 1% full.

If the required MAP entry is shown in the `rtrv-map` output, continue the procedure with [13](#).

If the required MAP entry is not shown in the `rtrv-map` output, continue the procedure with [11](#).

11. Display the EAGLE self-identification, using the `rtrv-sid` command.

This is an example of the possible output.

```
rlghncxa03w 10-07-10 11:43:04 GMT EAGLE5 42.0.0
```

```

PCA           PCI           PCN           CLLI           PCTYPE
010-020-030   1-023-1           12-0-14-1     rlghncxa03w    OTHER
                   s-1-023-1         s-12-0-14-1

```

```

CPCA
002-002-002   002-002-003       002-002-004   002-002-005
002-002-006   002-002-007       002-002-008   002-002-009
004-002-001   004-003-003       050-060-070

```

```

CPCI
1-001-1       1-001-2           1-001-3       1-001-4
1-002-1       1-002-2           1-002-3       1-002-4
2-001-1       7-222-7

```

```

CPCN
2-0-10-3     2-0-11-0         2-0-11-2     2-0-12-1
2-2-3-3     2-2-4-0         10-14-10-1

```

If the point code that will be specified for the GTT action entry is not shown in this step as the EAGLE's point code, perform one of these procedures to provision the required MAP entry. After the required MAP entry has been provisioned, continue the procedure with [13](#).

- [Provisioning a Solitary Mated Application](#)

- [Provisioning a Dominant Mated Application](#)
- [Provisioning a Load Shared Mated Application](#)
- [Provisioning a Combined Dominant/Load Shared Mated Application](#)

If the point code that will be specified for the GTT action entry is shown in this step as the EAGLE's point code, perform one of these procedures to provision the required MAP entry. After the required MAP entry has been provisioned, continue the procedure with [12](#).

- [Provisioning a Solitary Mated Application](#)
- [Provisioning a Dominant Mated Application](#)

12. Enter the `rtrv-ss-appl` command to verify that either the LNP, EIR, V-Flex, ATINPQ, INP, or AIQ subsystem number (depending on which feature is on) is in the subsystem application table.

This is an example of the possible output.

```
rlghncxa03w 10-07-28 14:42:38 GMT EAGLE5 42.0.0
APPL      SSN      STAT
LNP      254      ONLINE
```

SS-APPL table is 20% FULL (1 of 5)

If the subsystem number is shown in the `rtrv-ss-appl` output, continue the procedure with [13](#).

If no subsystem number is shown in the `rtrv-ss-appl` output, or if the `rtrv-ss-appl` command is rejected, perform the procedures in one of these user's guide, depending on the type of subsystem you wish to use, to enable and turn on the feature as necessary, and add the subsystem to the subsystem application table.

- EIR subsystem – go to *EIR User's Guide*.
- INP subsystem – go to *INP/AINPQ User's Guide*.
- LNP subsystem – go to *ELAP Administration and LNP Feature Activation Guide*.
- V-Flex subsystem – go to *V-Flex User's Guide*.
- ATINPQ subsystem – go to *ATINP*.
- AIQ subsystem – go to *Analyzed Information Features User's Guide*.

13. Continue the procedure by performing one of these steps.

If the `loopset` parameter will be specified for the GTT action entry, continue the procedure with [14](#). If `LOOPSET` values are shown in the `rtrv-gttact` output and you wish to use one of these values for the GTT action entry, [14](#) does not need to be performed.

If the `loopset` parameter will not be specified for the GTT action entry, but the `cdgtmodid` or `cggtmodid` parameters will be specified for the GTT action entry, continue the procedure with [15](#). If `CDGTMODID` or `CGGTMODID` values are shown in the `rtrv-gttact` output and you wish to use one of these values for the GTT action entry, [15](#) does not need to be performed.

Continue the procedure with 16 if the GTT action entry will not contain these parameter values.

- If the `loopset`, `cdgtmodid`, and `cggtmodid` parameters will not be specified for the GTT action entry and the `act` value of the GTT action entry will be `dup`.
- If the `loopset`, `cdgtmodid`, `cggtmodid`, and the `defactid` parameters will not be specified for the GTT action entry and the `act` value of the GTT action entry will be `fwd`.

14. Display all the loopsets in the database by entering this command

```
rtrv-loopset:num=1000:force=yes
```

This is an example of the possible output.

LoopSet	Mode	Point Codes
cary2	notify	005-015-005 007-007-007 (ANSI) 033-004-003 033-007-003 005-027-005 007-004-007
cary4	notify	005-012-005 007-026-007 (ANSI) 003-049-003 033-002-003 005-008-055 007-014-007
apex3	discard	005-017-008 007-017-009 (ANSI) 033-005-043 005-014-005 005-017-005 007-014-007 033-002-043 005-038-005 007-009-027 033-003-043 005-012-005 007-002-027
apex4	discard	005-007-008 027-007-009 (ANSI) 033-005-003 005-004-055 027-001-007 033-008-003 033-007-003 005-003-055 027-008-007
ral5	notify	005-005-005 007-007-007 (ANSI) 003-004-003 003-001-003 005-007-005 007-004-007 003-002-003 005-008-005 007-009-007 003-003-003 005-002-005 007-002-007
ral6	notify	005-007-008 007-007-009 (ANSI) 003-005-003 003-007-003 005-007-005
dunn1	discard	005-002-055 007-051-007 (ANSI) 003-008-033
rtp9	discard	005-002-005 007-001-007 (ANSI) 003-008-003 003-007-003 005-003-005 007-008-007 005-004-005
rtp5	discard	005-007-008 007-007-009 (ANSI) 003-005-003
rtp1	discard	005-005-005 007-007-007 (ANSI) 003-004-003 003-007-003 005-007-005 007-004-007 005-004-005

```
rtp2          notify          005-007-008    007-007-009 (ANSI)
              003-005-003
```

```
rlghncxa03w 09-05-28 21:15:37 GMT EAGLE5 41.0.0
LOOPSET table is (11 of 1000) 1% full
RTRV-LOOPSET: MASP A - COMPLTD
```

 **Note:**

If the `rtrv-loopset` command is entered with no other parameters specified, a maximum of 50 entries are displayed. To display more than 50 entries, the `force=yes` parameter must be specified with the `rtrv-loopset` command and the `num` parameter value must be greater than 50. Since there can be a maximum of 1000 loopsets in the database, to display all the loopsets in the database, the `force=yes` and `num = 1000` parameters must be specified with the `rtrv-loopset` command.

If the required loopset is not shown in the `rtrv-loopset` output, perform the [Adding a Loopset](#) procedure to add the required loopset.

If the required loopset is shown in the `rtrv-loopset` output, or if the [Adding a Loopset](#) procedure was performed and the `cdgtmodid` or `cggtmodid` parameters will be specified for the GTT action entry, continue the procedure with [15](#).

If `CDGTMODID` or `CGGTMODID` values are shown in the `rtrv-gttact` output and you wish to use one of these values for the GTT action entry, [15](#) does not need to be performed. Continue the procedure with [16](#).

 **Note:**

If an ANSI point code will be assigned to the GTT action entry when this procedure is completed, the `NGTI` value in the GT modification entry must be 2.

15. Display the GT modification information in the database using the `rtrv-gtmod` command.

This is an example of the possible output.

```
rlghncxa03w 10-07-07 00:29:31 GMT EAGLE5 42.0.0

GTMODID  NTT  NGTI  GT0FILL  NNP  NNAI  NPDD  NSDD  PRECD  CGPASSN
modid2   --   2     ON      --   --    --    --    PFX    --
NPDS=
modid5   --   2     OFF     --   --    --    --    PFX    --
NPDS=
modid6   --   4     ON      4     5     3     3     SFX    --
NPDS=123
modid10  --   --     OFF     5     5     --    --    PFX    --
NPDS=
NSDS=456
```

```
modid11  --  --  OFF  5  5  --  --  PFX  --
          NPDS=                NSDS=
```

GTMOD table is (5 of 100000) 1% full.

If the desired GT modification entry is not displayed, perform the [Adding Global Title Modification Information](#) procedure to add the desired GT modification entry to the database.

If the desired GT modification entry is displayed or the [Adding Global Title Modification Information](#) procedure was performed, continue the procedure with 16.

 **Note:**

If an ANSI point code will be assigned to the GTT action entry when this procedure is completed, theNGTI value in the GT modification entry must be 2.

16. Change the GTT action entry using the `chg-gttact` command.

[Table 4-51](#) shows the parameter combinations that can be used with the `chg-gttact` command.

For this example, enter these commands.

```
chg-
gttact:actid=action10:nactid=action50:act=dup:pc=002-002-002:
ri=gt :mrnset=2:cdgtmodid=modid2:cggmodid=modid5:loopset=loo
p1:on=useicmsg
```

```
chg-
gttact:actid=action1:nactid=action60:act=tcaperr:atcaperr=40:
itcaperr=60
```

When this command has successfully completed, this message should appear.

```
rlghncxa03w 10-07-07 00:29:31 GMT EAGLE5 42.0.0
```

```
GTT-ACT table is (15 of 2000) 1% full.
```

```
CHG-GTTACT: MASP A - COMPLTD
```

17. Verify the changes using the `rtrv-gttact` command with the current name of the GTT action entry that was changed, if the name the GTT action entry was not changed in 16, or the new name of the GTT action entry if the name of the GTT action entry was changed in 16.

For this example, enter these commands.

```
rtrv-gttact:actid=action50
```

The following is an example of the possible output.

```
rlghncxa03w 10-07-07 00:27:31 GMT EAGLE5 42.0.0
```

```
ACTID      ACTION  ATCAPERR ITCAPERR UDTSERR UIMREQD
-----
```

```
ACTID      ACTION  PCA          RI  SSN  MRNSET  MAPSET
-----
```

```
---
action50  dup      002-002-002  gt  ---  2      -----
          CDGTMODID = modid2      CGGTMODID = modid5
          LOOPSET = loop1
          USEICMSG = on          CGPCOGMSG = dflt          CGPCA = ---
```

```
ACTID      ACTION  PCI          RI  SSN  MRNSET  MAPSET
-----
```

```
---
```

```
ACTID      ACTION  PCN          RI  SSN  MRNSET  MAPSET
-----
```

```
---
```

```
ACTID      ACTION  PCN24        RI  SSN  MRNSET  MAPSET
-----
```

```
---
```

GTT-ACT table is (15 of 2000) 1% full.

```
rtrv-gttact:actid=action60
```

The following is an example of the possible output.

```
rlghncxa03w 10-07-07 00:27:31 GMT EAGLE5 42.0.0
```

```
ACTID      ACTION  ATCAPERR ITCAPERR UDTSERR UIMREQD
-----
```

```
action60  tcaperr 40      60      ---     off
```

GTT-ACT table is (15 of 2000) 1% full.

- Backup the new changes using the `chg-db:action=backup:dest=fixed` command.

These messages should appear, the active Maintenance and Administration Subsystem Processor (MASP) appears first.

```
BACKUP (FIXED) : MASP A - Backup starts on active MASP.
BACKUP (FIXED) : MASP A - Backup on active MASP to fixed disk
complete.
BACKUP (FIXED) : MASP A - Backup starts on standby MASP.
```

BACKUP (FIXED) : MASP A - Backup on standby MASP to fixed disk complete.

Figure 4-52 Change a GTT Action - Sheet 1 of 10

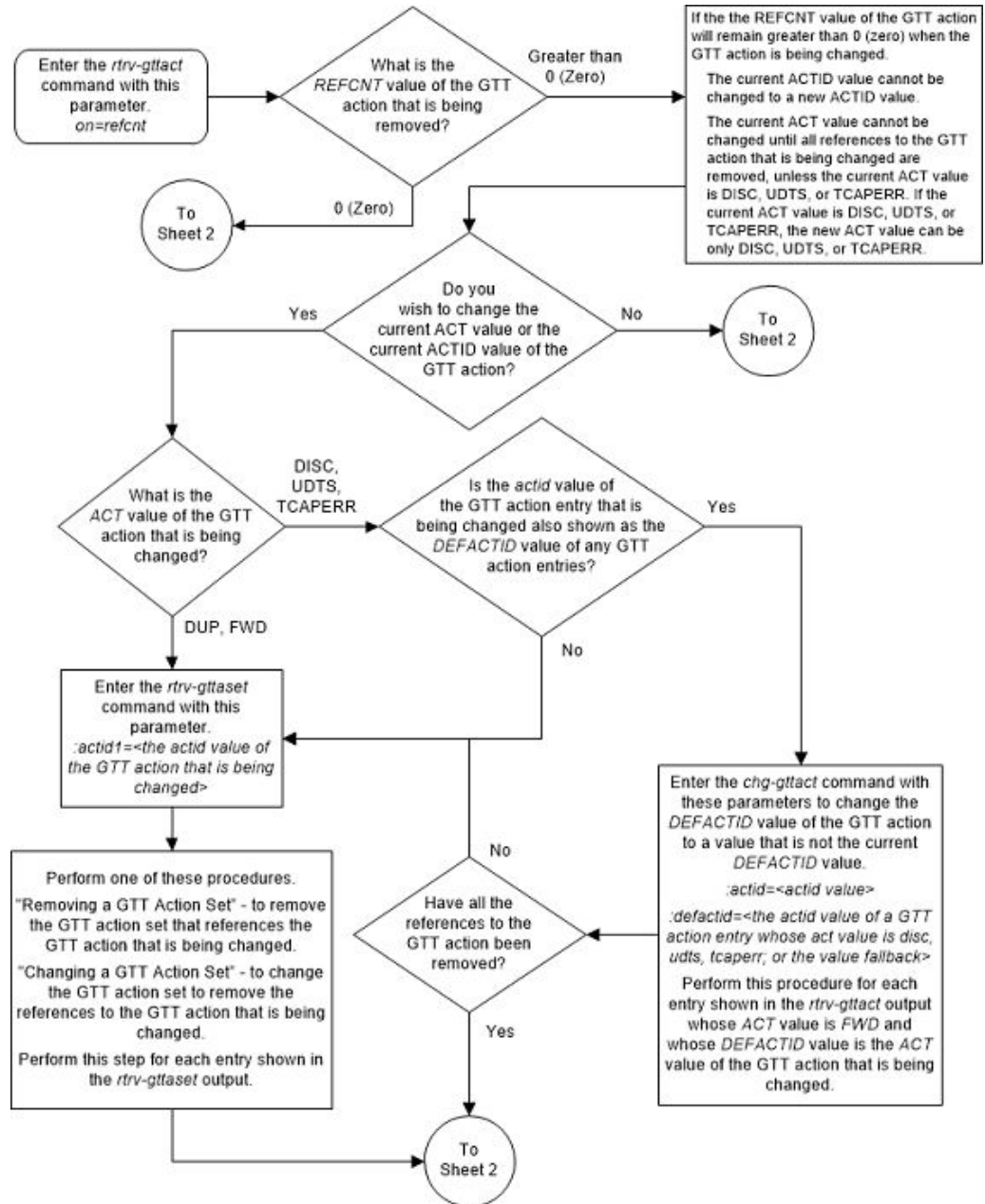

Figure 4-53 Change a GTT Action - Sheet 2 of 10

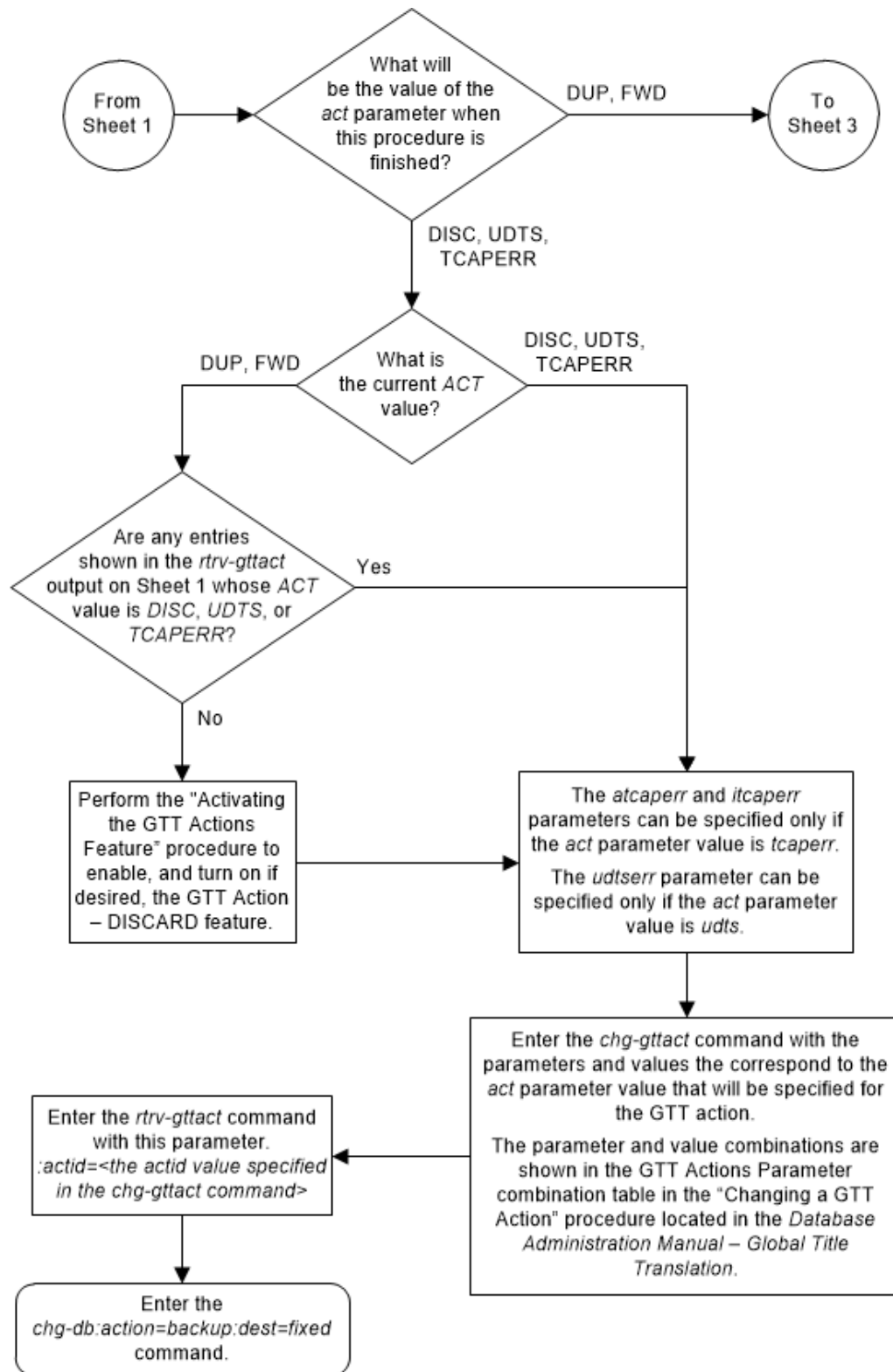

Figure 4-54 Change a GTT Action - Sheet 3 of 10

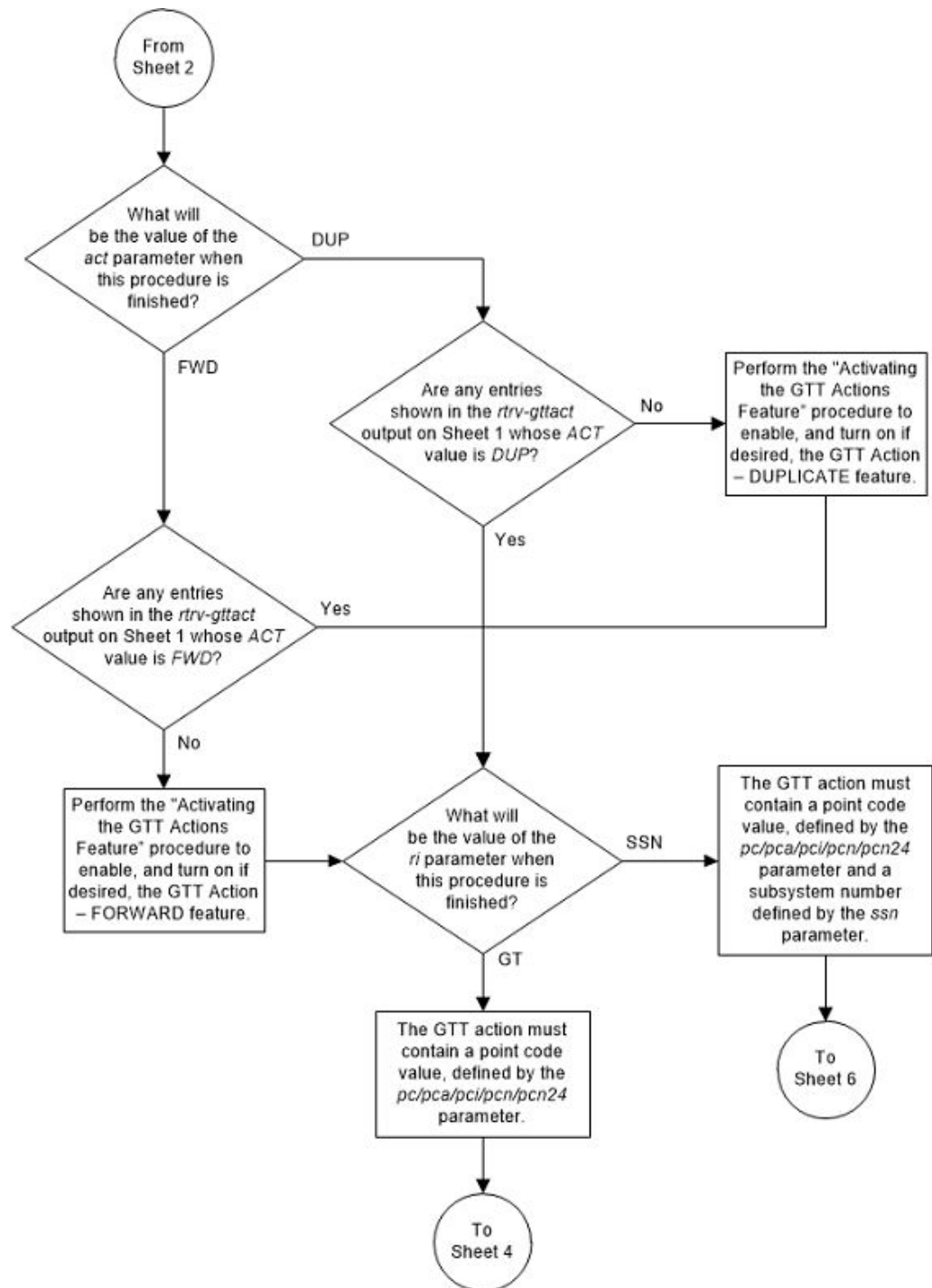

Figure 4-55 Change a GTT Action - Sheet 4 of 10

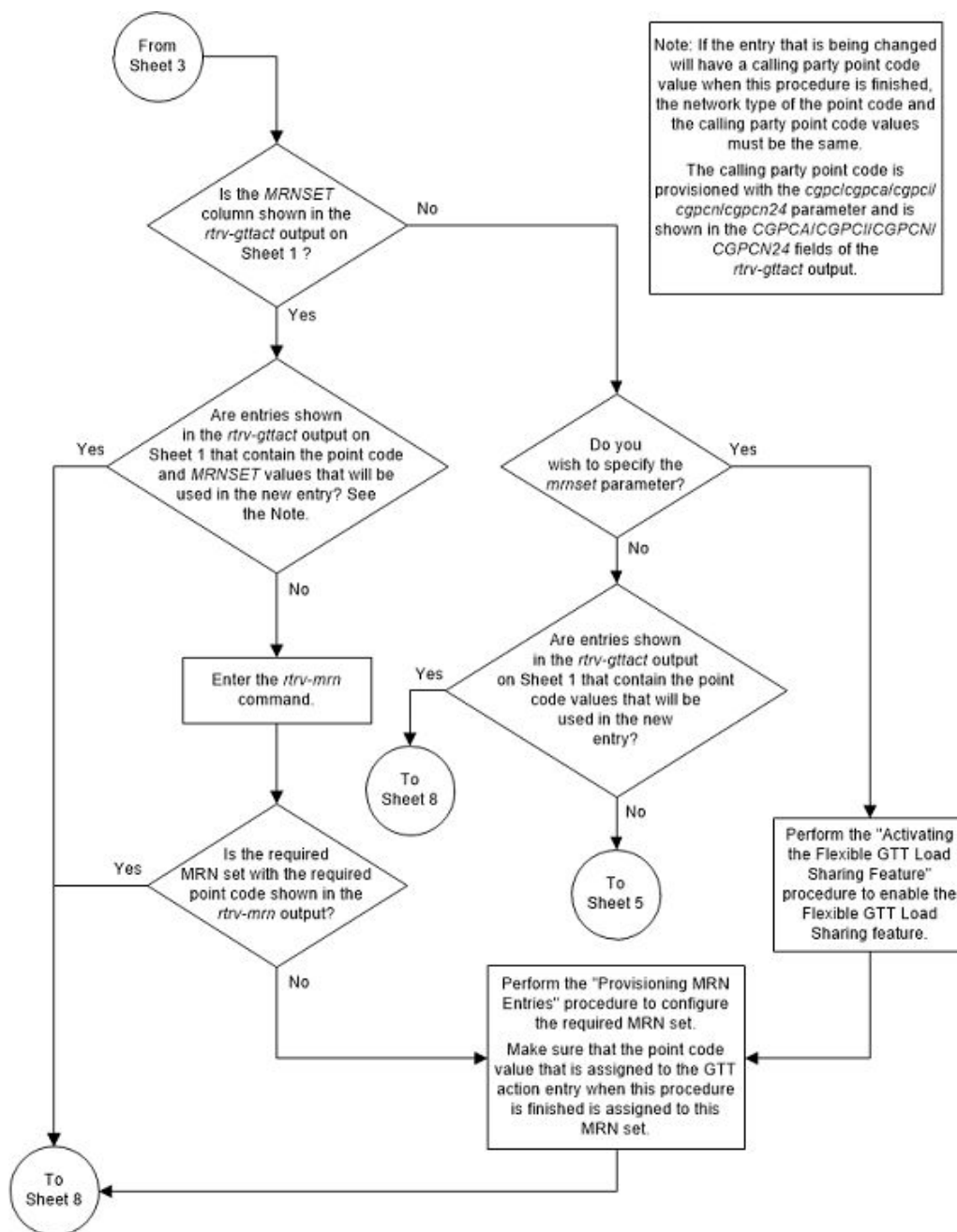

Figure 4-56 Change a GTT Action - Sheet 5 of 10

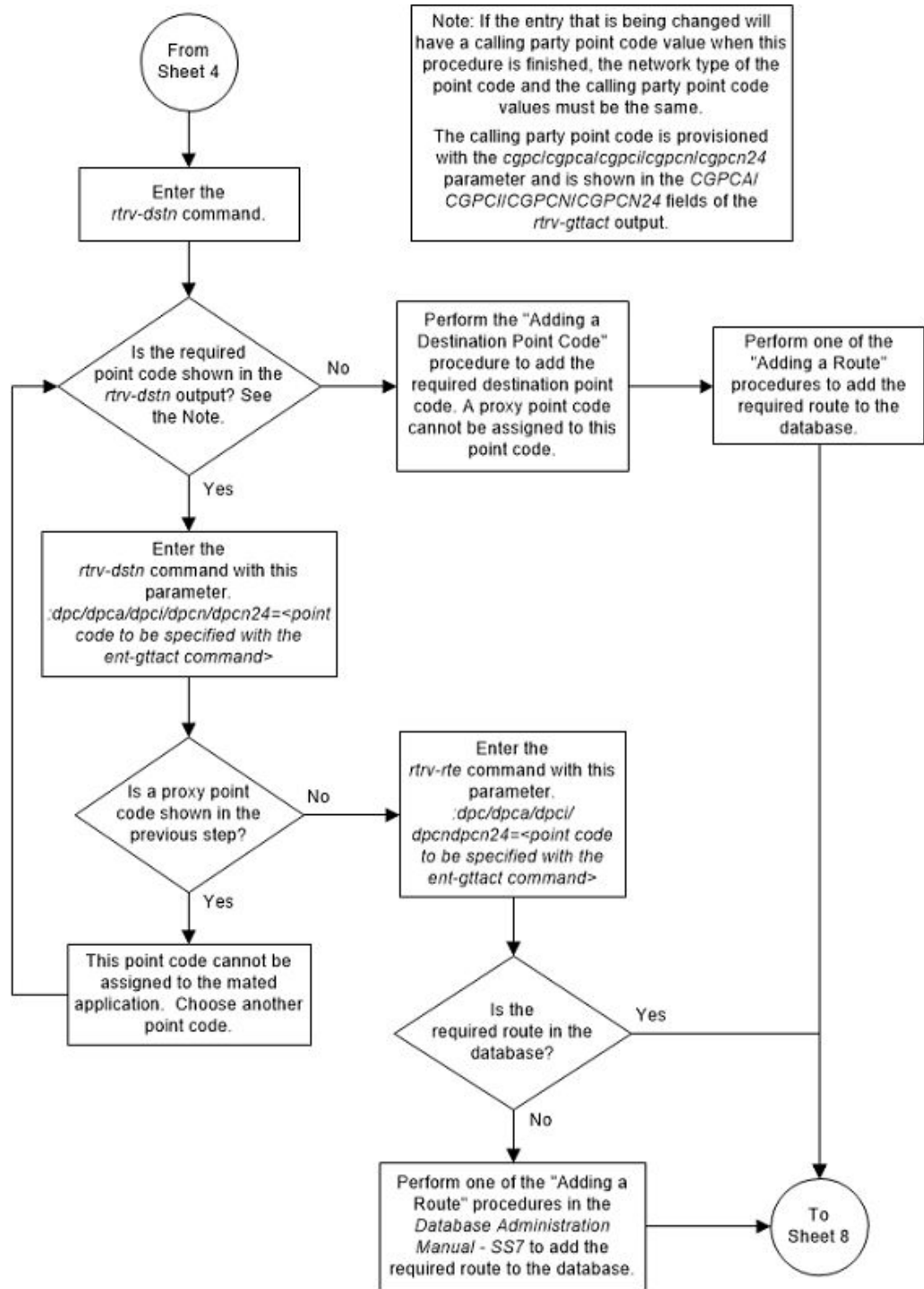

Figure 4-57 Change a GTT Action - Sheet 6 of 10

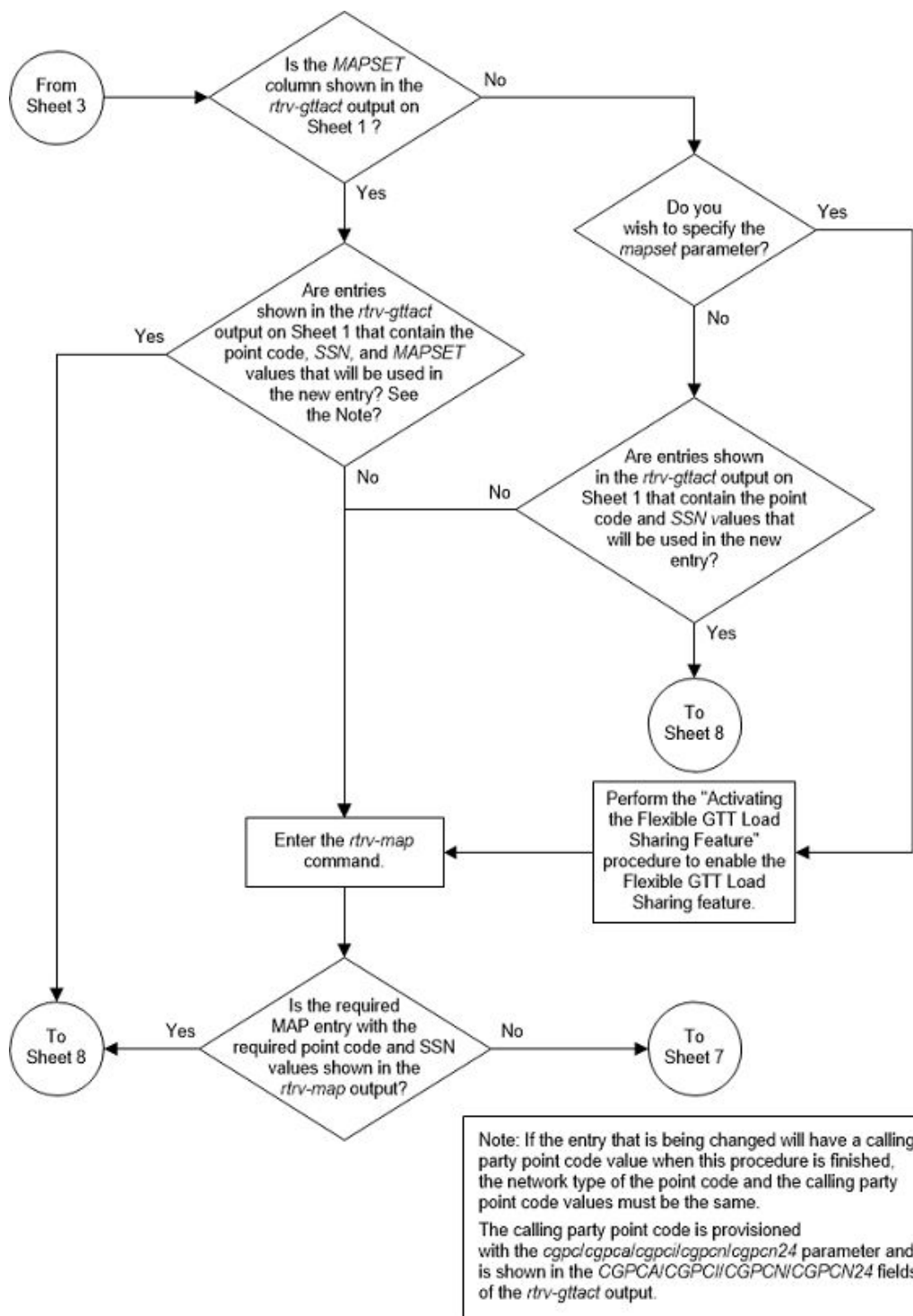

Figure 4-58 Change a GTT Action - Sheet 7 of 10

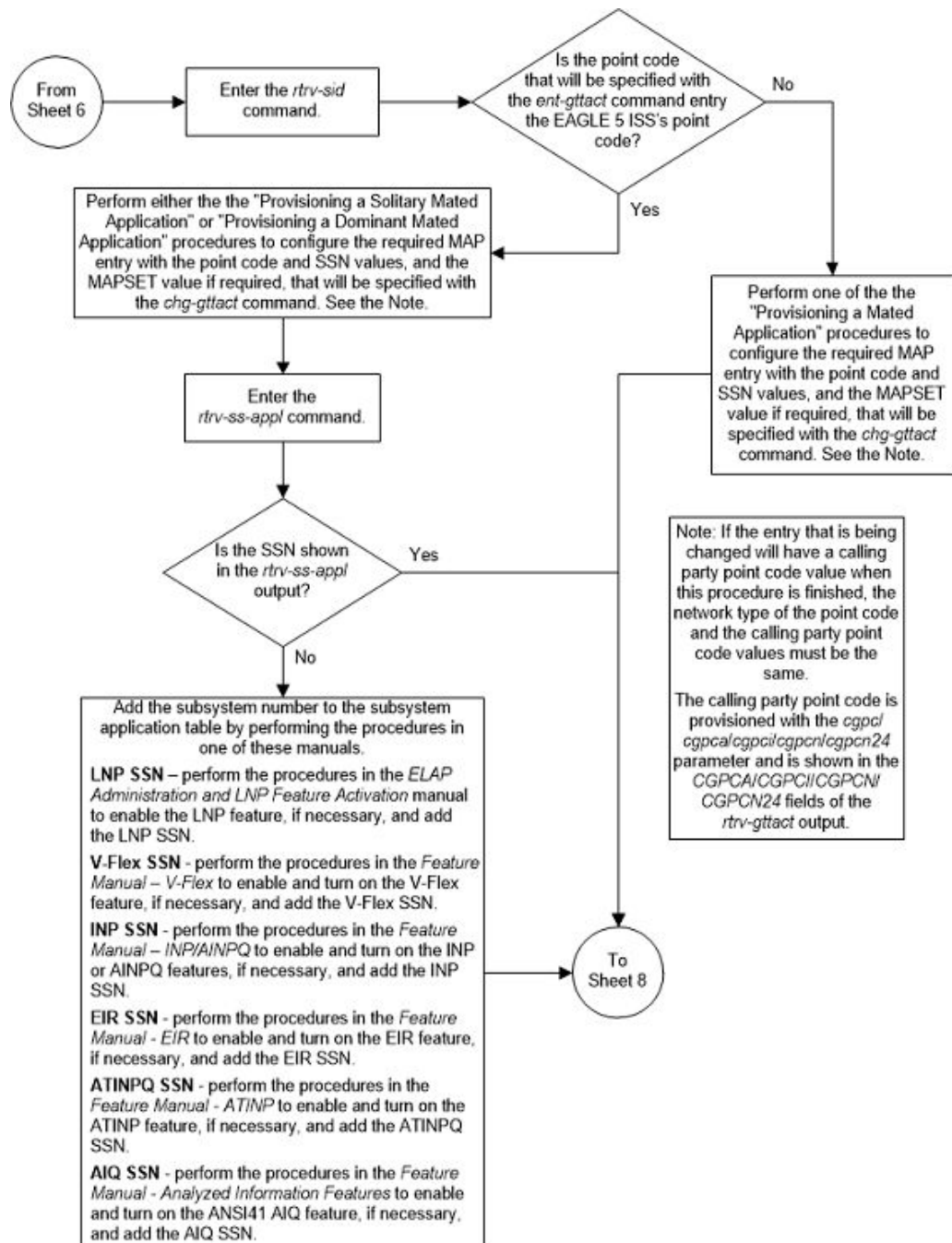

Figure 4-59 Change a GTT Action - Sheet 8 of 10

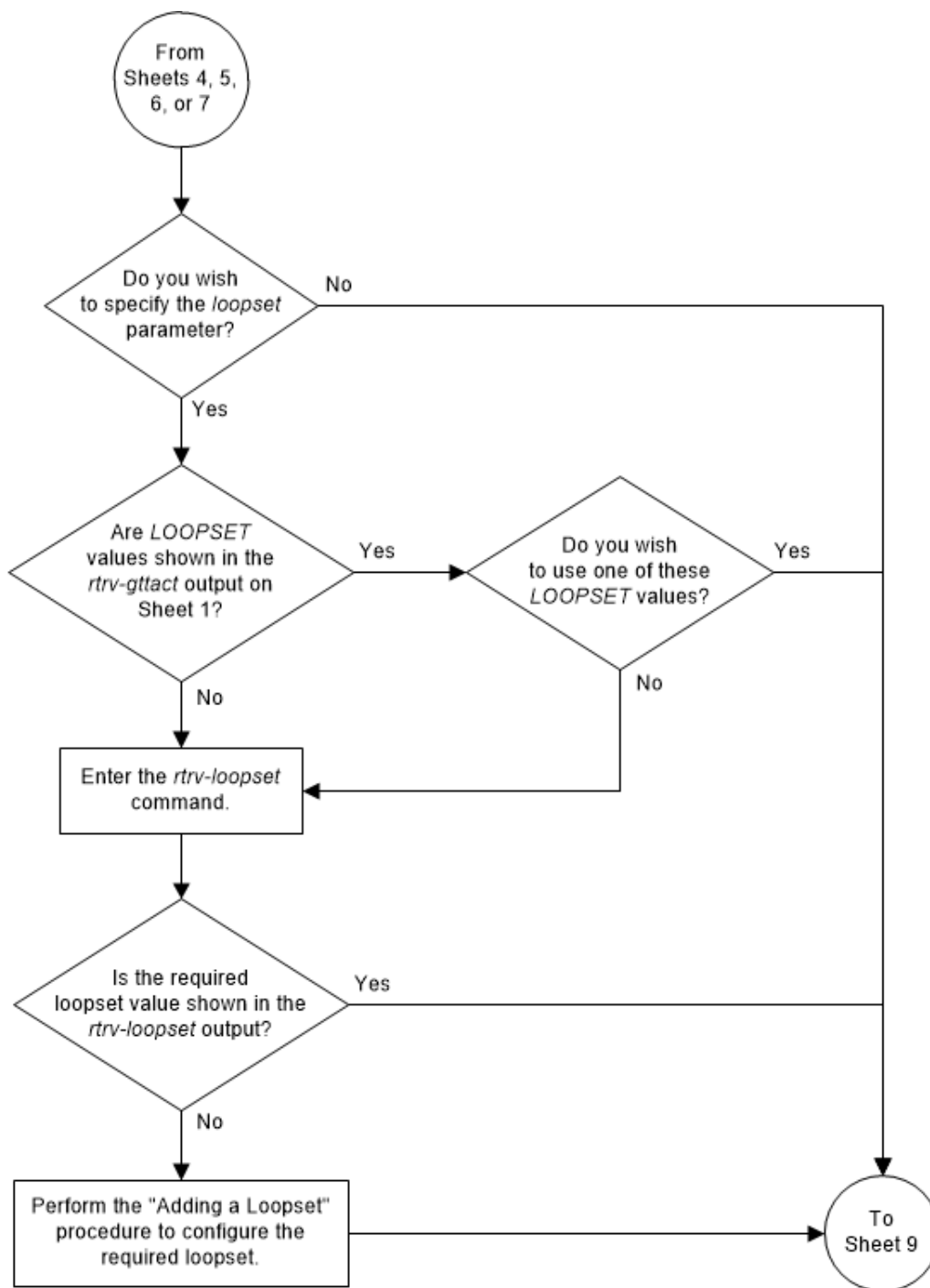

Figure 4-60 Change a GTT Action - Sheet 9 of 10

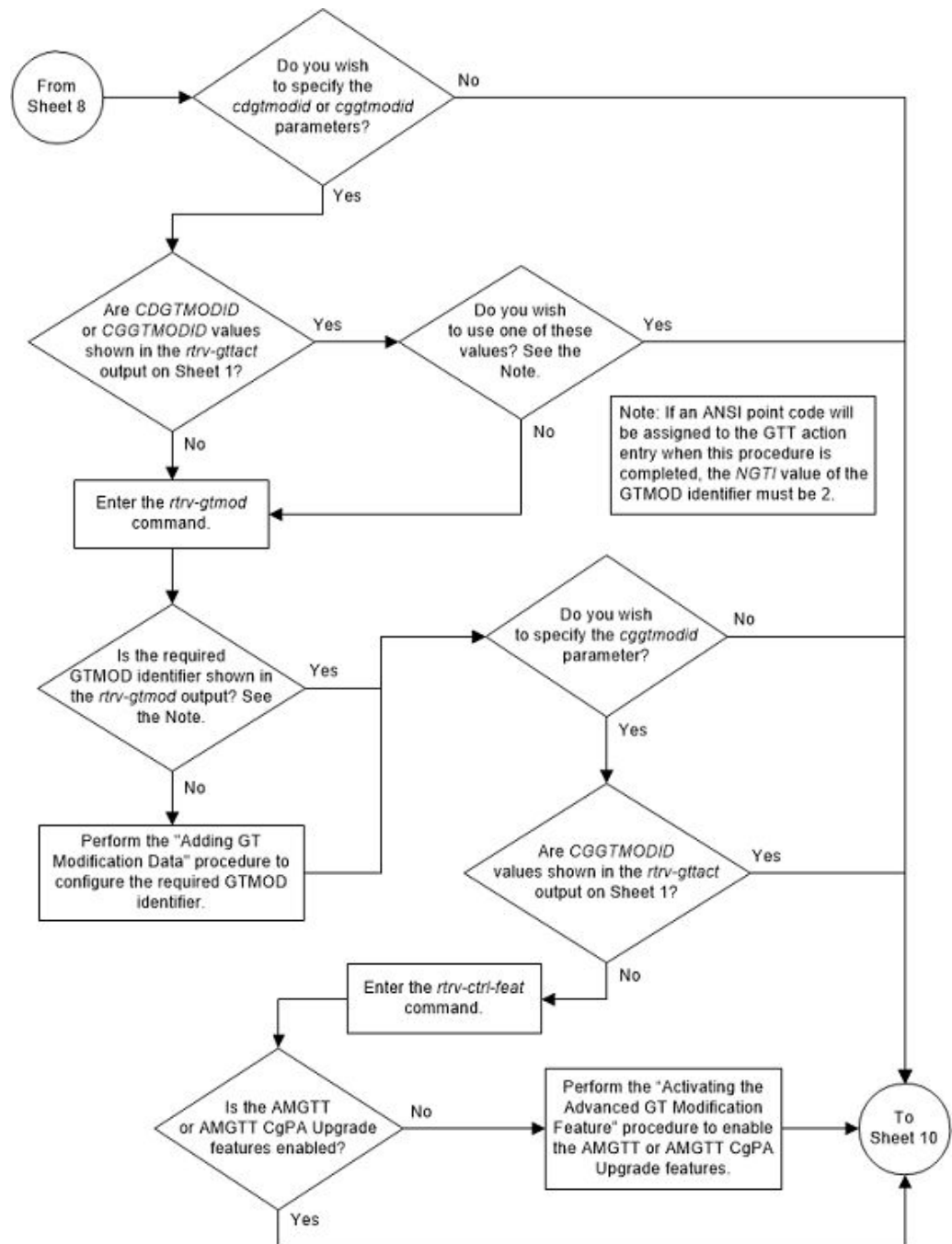
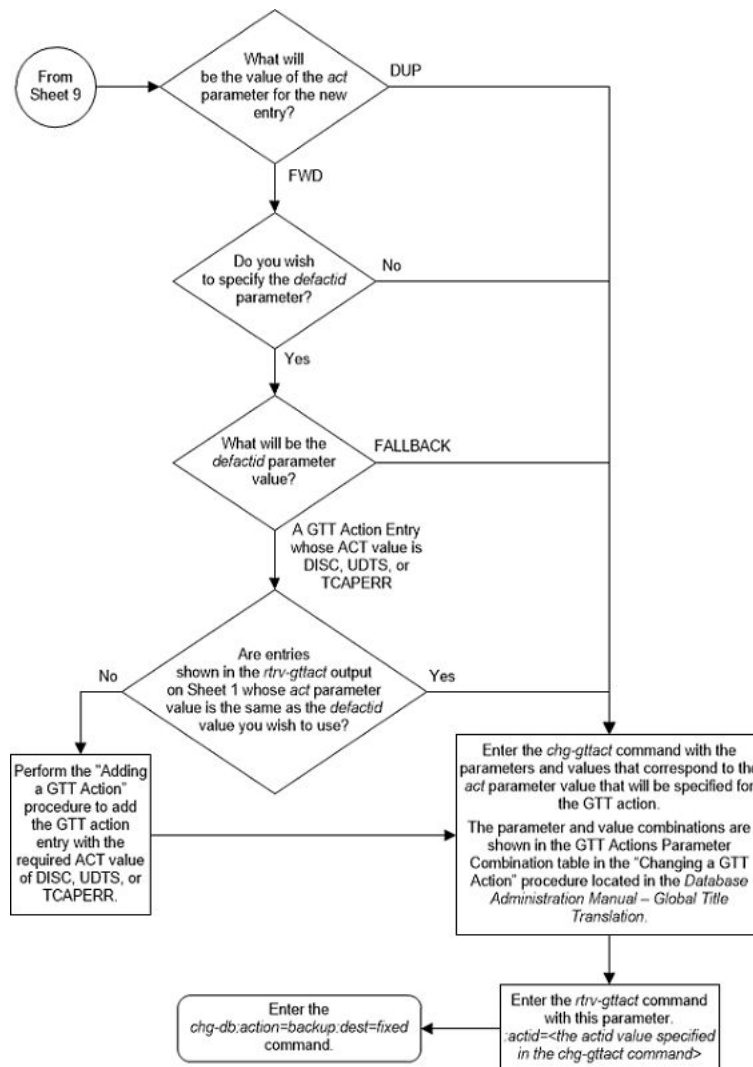

Figure 4-61 Change a GTT Action - Sheet 10 of 10



Adding a GTT Action Set

This procedure to add a GTT action set to the database using the `ent-gttaset` command. A GTT action set is a group of GTT actions, provisioned by the [Adding a GTT Action](#) procedure. The GTT action set is assigned to a GTA entry using either the `ent-gta` or `chg-gta` commands.

The `ent-gttaset` command uses these parameters.

`:actsn` – The name of the GTT action set consisting of one alphabetic character and up to eight alphanumeric characters.

`:actid1` – The identifier of the GTT action that is being added to the GTT action set.

`:actid2` – The identifier of the GTT action that is being added to the GTT action set.

`:actid3` – The identifier of the GTT action that is being added to the GTT action set.

- :actid4 – The identifier of the GTT action that is being added to the GTT action set.
- :actid5 – The identifier of the GTT action that is being added to the GTT action set.
- :actid6 – The identifier of the GTT action that is being added to the GTT action set.
- :on=testmode – The GTT action set is used only by the test message tool.
- :off=testmode – The GTT action set is used for real-time message processing.

The values of the `actid` parameters are shown in either the `rtrv-gttact` output or assigned to an existing GTT action set and shown in the `rtrv-gttaset` output.

1. Display the GTT action sets in the database by entering the `rtrv-gttaset` command. This is an example of the possible output.

```
rlghncxa03w 10-07-07 00:29:31 GMT EAGLE5 42.0.0
```

```
ACTSN      TEST  ActIds
          MODE
-----
act2      off  action2 (DISC),-----,-----,
          -----,-----,-----
act3      off  action2 (DISC),-----,-----,
          -----,-----,-----
```

GTT-ASET table is (2 of 20000) 1% full.

If the `rtrv-gttaset` output contains 20,000 entries, this procedure cannot be performed. The database can contain a maximum of 20,000 GTT action sets.

If the `rtrv-gttaset` output contains less than 20,000 entries, continue the procedure by performing one of these steps.

- If all the GTT actions that will be assigned to the new GTT action set are shown in the `rtrv-gttaset` output, continue the procedure with [3](#).
- If any of the GTT actions that will be assigned to the new GTT action set are not shown in the `rtrv-gttaset` output, continue the procedure with [2](#).

If error message “E3557 Cmd Rej: EGTT must be ON before this command can be entered,” is displayed, the EGTT feature is not on. Perform [Adding a Service Module](#) to turn the EGTT feature on and to make sure that the correct hardware is installed and provisioned. After [Adding a Service Module](#) has been performed, continue the procedure with [2](#).

2. Display the GTT actions that are in the database by entering the `rtrv-gttact` command.

This is an example of the possible output.

```
rlghncxa03w 10-07-07 00:28:31 GMT EAGLE5 42.0.0
```

```
ACTID      ACTION  ATCAPERR  ITCAPERR  UDTSEERR  UIMREQD
-----
action2    disc    ---       ---       ---       off
action10   disc    ---       ---       ---       off
action11   disc    ---       ---       ---       on
```

```

action15  udts    ---    ---    7    off
action16  tcaperr  0      0      ---  off
action17  tcaperr  10     20     ---  off

```

```

ACTID      ACTION    PCA          RI  SSN  MRNSET  MAPSET
-----
---
action1    dup      002-002-002  gt  ---  DFLT    -----
          CDGTMODID = -----  CGGTMODID = -----
          LOOPSET = None
          USEICMSG = off    CGPCOGMSG = dflt    CGPCA = ---
action3    dup      002-002-002  gt  ---  DFLT    -----
          CDGTMODID = modid2  CGGTMODID = -----
          LOOPSET = None
          USEICMSG = off    CGPCOGMSG = dflt    CGPCA = ---
action4    dup      002-002-002  gt  ---  DFLT    -----
          CDGTMODID = -----  CGGTMODID = modid2
          LOOPSET = None
          USEICMSG = off    CGPCOGMSG = dflt    CGPCA = ---
action20   dup      002-002-002  gt  ---  DFLT    -----
          CDGTMODID = -----  CGGTMODID = -----
          LOOPSET = None
          USEICMSG = off    CGPCOGMSG = dflt    CGPCA = ---
action21   dup      002-002-002  ssn 50  ----  DFLT
          CDGTMODID = -----  CGGTMODID = -----
          LOOPSET = None
          USEICMSG = off    CGPCOGMSG = dflt    CGPCA = ---
action22   fwd      002-002-002  ssn 50  ----  DFLT
          CDGTMODID = -----  CGGTMODID = -----
          LOOPSET = None    DEFACTID = Fallback
          USEICMSG = off    CGPCOGMSG = dflt    CGPCA = ---
action23   fwd      002-002-002  gt  ---  DFLT    -----
          CDGTMODID = -----  CGGTMODID = -----
          LOOPSET = None    DEFACTID = Fallback
          USEICMSG = off    CGPCOGMSG = dflt    CGPCA = ---
action24   fwd      002-002-002  gt  ---  NONE    -----
          CDGTMODID = -----  CGGTMODID = -----
          LOOPSET = None    DEFACTID = Fallback
          USEICMSG = off    CGPCOGMSG = dflt    CGPCA = ---
action25   fwd      002-002-002  gt  ---  NONE    -----
          CDGTMODID = -----  CGGTMODID = -----
          LOOPSET = None    DEFACTID = Fallback
          USEICMSG = off    CGPCOGMSG = dflt    CGPCA = ---

```

```

ACTID      ACTION    PCI          RI  SSN  MRNSET  MAPSET
-----
---

```

```

ACTID      ACTION    PCN          RI  SSN  MRNSET  MAPSET
-----
---

```

```

ACTID      ACTION      PCN24      RI  SSN  MRNSET  MAPSET
-----
---
```

GTT-ACT table is (15 of 2000) 1% full.

If the required GTT actions are shown in the `rtrv-gttact` output, continue the procedure with [3](#).

If the required GTT actions are not shown in the `rtrv-gttact` output, perform the [Adding a GTT Action](#) procedure to add the required GTT actions to the database. After the [Adding a GTT Action](#) procedure has been performed, continue the procedure with [3](#).

3. Add the GTT action set to the database using the `ent-gttaset` command.

A GTT action set can contain these combinations of GTT actions.

- A GTT action set can contain a maximum of six GTT actions.
- The GTT action set can contain one GTT action whose ACT value is either `disc`, `udts`, `tcaperr`, or `fwd`.
- If the ACT value one of the GTT actions in the GTT action set is `fwd`, the ACT values of the other GTT actions in the GTT action set can only be `dup`.
- The GTT action set can contain a maximum of five GTT actions whose ACT value is `dup`.
- GTT actions whose ACT value is `disc`, `udts`, `tcaperr`, or `fwd` must be the last entry in the GTT action set.
- All the ACTID values in the GTT action set must be unique.

For this example, enter these commands.

```

ent-
gttaset:actsn=act1:actid1=action1:actid2=action4:actid3=actio
n25
```

```

ent-
gttaset:actsn=act5:actid1=action1:actid2=action3:actid3=actio
n4:actid4=action20 :actid5=action21:actid6=action17:on=testmo
de
```

When each of these commands have successfully completed, this message should appear.

```

rlghncxa03w 10-07-07 00:29:31 GMT EAGLE5 42.0.0
```

GTT-ASET table is (4 of 20000) 1% full.

```

ENT-GTTASET: MASP A - COMPLTD
```

If the `on=testmode` parameter is specified, this message appears in the output of the `ent-gttaset` command in addition to the other information that is displayed.

WARNING: Processing of traffic shall be affected when testmode is ON

4. Verify the changes using the `rtrv-gttaset` command with the `actsn` parameter and value specified in 3.

For this example, enter these commands.

```
rtrv-gttaset:actsn=act1
```

```
rlghncxa03w 10-07-07 00:30:31 GMT EAGLE5 42.0.0
```

```
ACTSN      TEST  ActIds
          MODE
-----
act1      off  action1 (DUP),action4 (DUP),action25 (FWD),
          -----,-----,-----
```

GTT-ASET table is (4 of 20000) 1% full.

```
rtrv-gttaset:actsn=act5
```

```
rlghncxa03w 10-07-07 00:30:31 GMT EAGLE5 42.0.0
```

```
ACTSN      TEST  ActIds
          MODE
-----
act5      on   action1 (DUP),action3 (DUP),action4 (DUP),
          action20 (DUP),action21 (DUP),action17 (TCAPERR)
```

GTT-ASET table is (4 of 20000) 1% full.

5. Backup the new changes using the `chg-db:action=backup:dest=fixed` command. These messages should appear, the active Maintenance and Administration Subsystem Processor (MASP) appears first.

```
BACKUP (FIXED) : MASP A - Backup starts on active MASP.
```

```
BACKUP (FIXED) : MASP A - Backup on active MASP to fixed disk
complete.
```

```
BACKUP (FIXED) : MASP A - Backup starts on standby MASP.
```

```
BACKUP (FIXED) : MASP A - Backup on standby MASP to fixed disk
complete.
```

Figure 4-62 Add a GTT Action Set

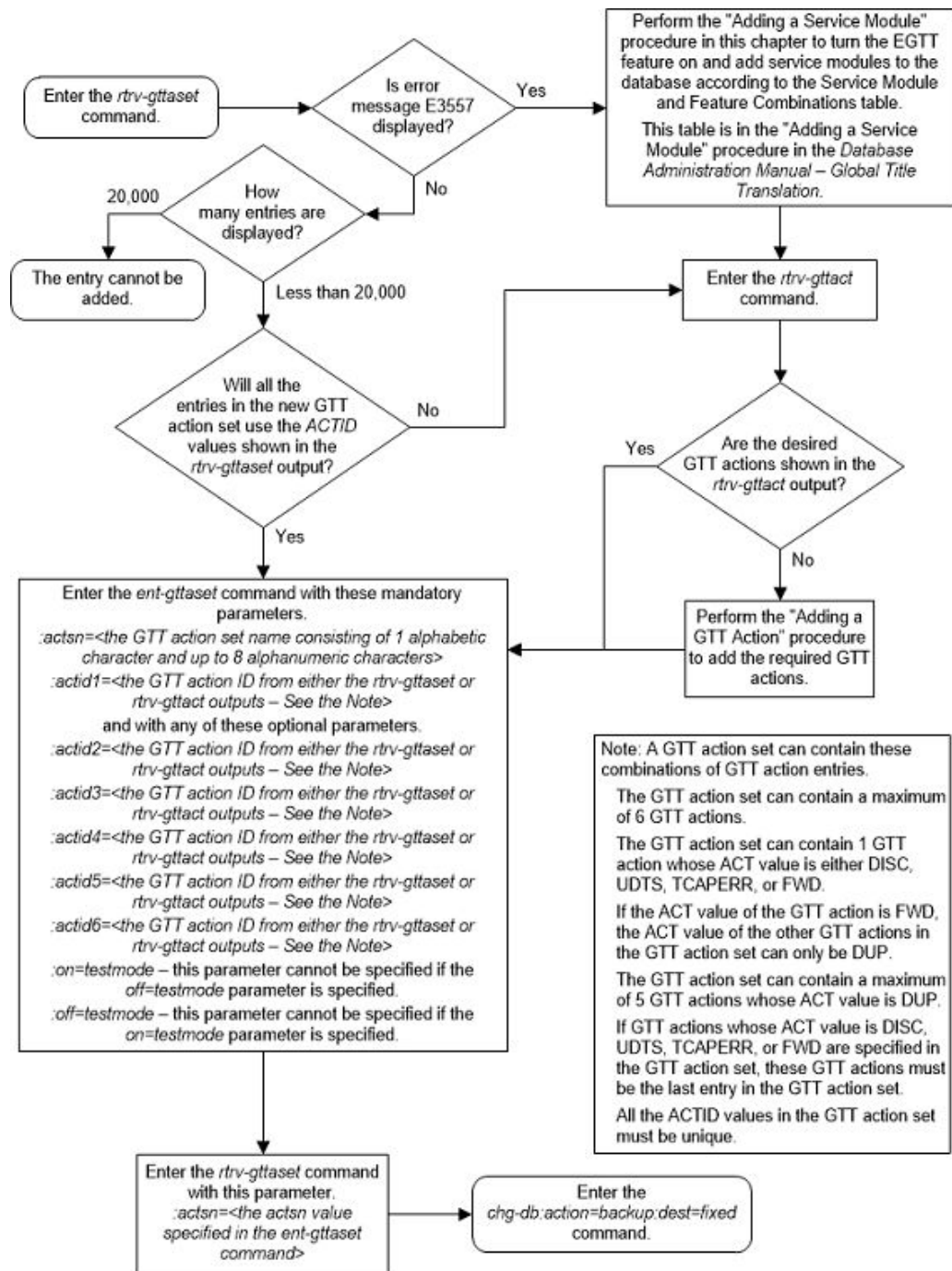

Removing a GTT Action Set

This procedure to remove a GTT action set from the database using the `dlt-gttaset` command.

The `dlt-gttaset` command uses this parameter.

:actsn – The name of the GTT action set shown in the `rtrv-gttaset` output.

The GTT set action cannot be removed if it is referenced by a GTA entry, configured with the `ent-gta` or `chg-gta` commands. The `rtrv-gta` command output shows the GTA entries.

1. Display the existing GTT action sets from the database by entering this command.

```
rtrv-gttaset:on=refcnt
```

This is an example of the possible output.

```
rlghncxa03w 10-07-07 00:27:31 GMT EAGLE5 42.0.0
```

ACTSN	REFCNT	TEST MODE	ActIds
action1	0	off	action1 (DUP),-----,-----, -----,-----,-----
act2	0	off	action2 (DISC),-----,-----, -----,-----,-----
act3	0	off	action2 (DISC),-----,-----, -----,-----,-----

GTT-ASET table is (3 of 20000) 1% full.

If the number of entities that reference the GTT action set, the reference count, that is being removed is 0 (zero), continue the procedure with [4](#) The reference count is shown in the `REFCNT` column in the `rtrv-gttaset` output.

If the number of entities that reference the GTT action set that is being removed is greater than 0 (zero), continue the procedure with [2](#)

2. Display the GTT sets that contain the GTA entries that reference the GTT action set that is being removed. Enter the `rtrv-gttset` command with the name GTT action set shown in [1](#).

For this example, enter this command.

```
rtrv-gttset:actsn=act2
```

This is an example of the possible output.

```
rlghncxa03w 10-07-07 00:28:31 GMT EAGLE5 42.0.0
```

GTTSN	NETDOM	SETTYPE	NDGT
setans010	ansi	CDGTA	6

GTT-SET table is (8 of 2000) 1% full.

3. Display the GTA entries that are assigned to the GTT set shown in [2](#) by entering the `rtrv-gta` command with these parameters.

- :gttsn - The `GTTSN` value shown in [2](#).
- :actsn - The `actsn` parameter value specified in [2](#).

For this example, enter this command.

```
rtrv-gta:gttsn=setans010:actsn=act2
```

This is an example of the possible output.

```
rlghncxa03w 10-07-07 00:29:31 GMT EAGLE5 42.0.0
```

```
GTTSN      NETDOM  SETTYPE  NDGT
setans010  ansi    CDGTA    6
```

GTA table is (8 of 269999) 1% full.

```
START GTA END GTA  XLAT  RI    PC
888888  888888  DPC   SSN  002-002-002
      MAPSET=DFLT  SSN=--- CCGT=no CCGTMOD=NO
      GTMODID=----- TESTMODE=off
      LOOPSET = none
      OPTSN=----- CGSELID=----- OPCSN=-----
      ACTSN=act2     PPMEASREQD= NO
```

Command Retrieved 1 Entries

Continue the procedure by performing one of these procedures.

- [Removing Global Title Address Information](#) to remove the GTA entry that references the GTT action set specified in this step.
- [Changing Global Title Address Information](#) to remove the GTA entry reference another GTT action set or to reference no GTT action set.

Perform these procedures for each entry shown in this step.

4. Remove the GTT action set from the database using the `dlt-gttaset` command with the `ACTSN` parameter value of the GTT action set that is being removed.

For this example, enter this command.

```
dlt-gttaset:actsn=act2
```

When the command has successfully completed, this message should appear:

```
rlghncxa03w 10-07-07 00:29:31 GMT EAGLE5 42.1.0
```

GTT-ASET table is (2 of 20000) 1% full.

```
DLT-GTTASET: MASP A - COMPLTD
```

5. Verify the changes using the `rtrv-gttaset` command with the `actsn` parameter value specified in 4.

The following message is displayed.

```
E5196 Cmd Rej: GTT Action Set does not exist
```

6. Backup the new changes using the `chg-db:action=backup:dest=fixed` command.

These messages should appear, the active Maintenance and Administration Subsystem Processor (MASP) appears first.

```
BACKUP (FIXED) : MASP A - Backup starts on active MASP.  
BACKUP (FIXED) : MASP A - Backup on active MASP to fixed disk  
complete.  
BACKUP (FIXED) : MASP A - Backup starts on standby MASP.  
BACKUP (FIXED) : MASP A - Backup on standby MASP to fixed disk  
complete.
```

Figure 4-63 Remove a GTT Action Set

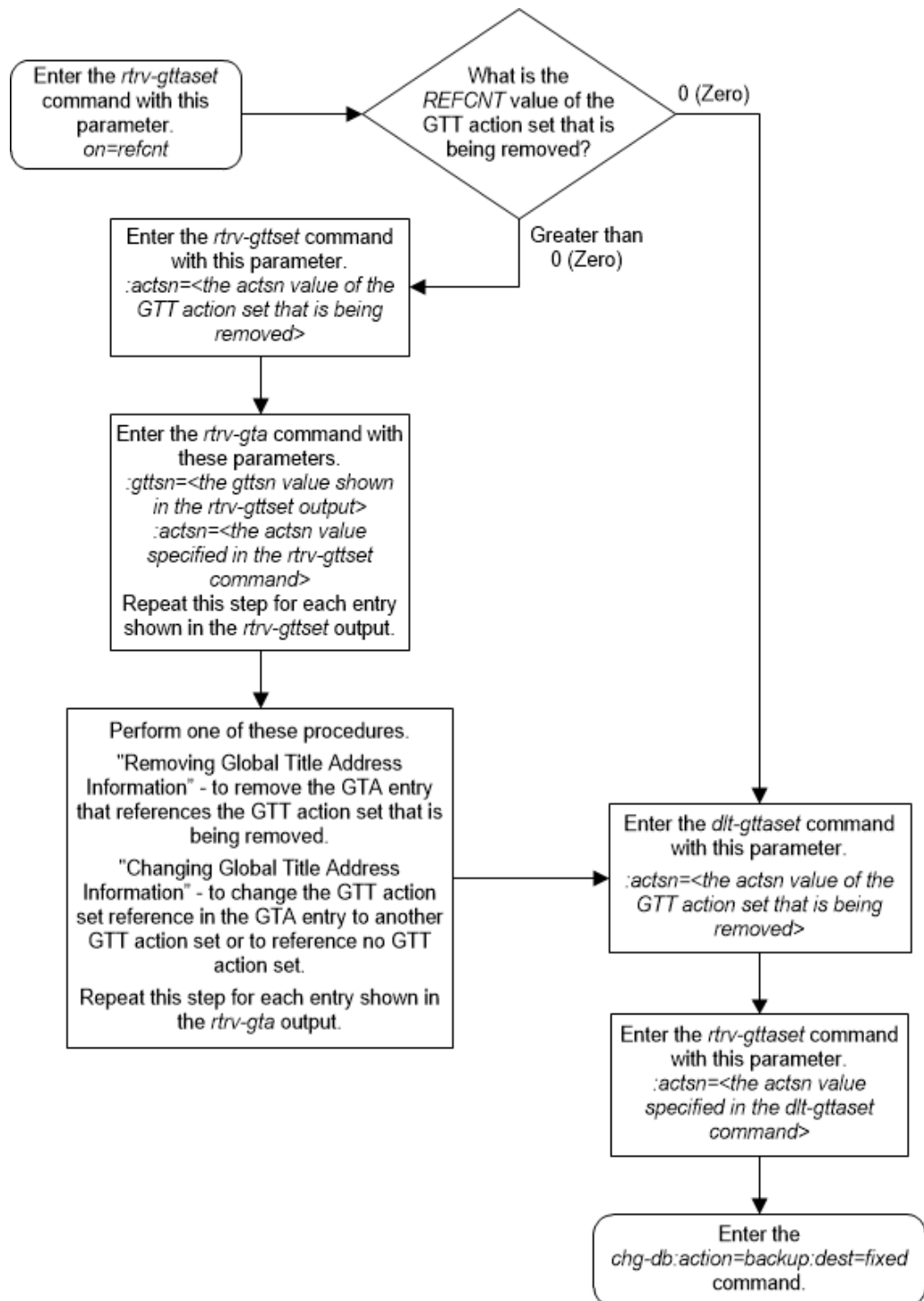

Changing a GTT Action Set

This procedure is used to change the attributes of a GTT action set using the `chg-gttaset` command.

The `chg-gttaset` command uses these parameters.

`:actsn` – The current name of the GTT action set shown in the `rtrv-gttaset` output.

`:nactsn` – The new name of the GTT action set consisting of one alphabetic character and up to eight alphanumeric characters.

`:actid1` – The identifier of the GTT action that is being added to the GTT action set,

`:actid2` – The identifier of the GTT action that is being added to the GTT action set.

`:actid3` – The identifier of the GTT action that is being added to the GTT action set.

`:actid4` – The identifier of the GTT action that is being added to the GTT action set.

`:actid5` – The identifier of the GTT action that is being added to the GTT action set.

`:actid6` – The identifier of the GTT action that is being added to the GTT action set.

`:on=testmode` – The GTT action set is used only by the test message tool.

`:off=testmode` – The GTT action set is used for real-time message processing.

The values of the `actid` parameters are shown in either the `rtrv-gttact` output or assigned to an existing GTT action set and shown in the `rtrv-gttaset` output.

1. Display the existing GTT action sets in the database by entering this command.

```
rtrv-gttaset:on=refcnt
```

This is an example of the possible output.

```
rlghncxa03w 10-07-07 00:29:31 GMT EAGLE5 42.0.0
```

ACTSN	REFCNT	TEST MODE	ActIds
act1 (FWD),	0	off	action1 (DUP),action4 (DUP),action25 (FWD),
act2	1	off	action2 (DISC),-----,-----, -----,-----,-----
act3	0	off	action2 (DISC),-----,-----, -----,-----,-----
act5 (DUP), (TCAPERR)	0	on	action1 (DUP),action3 (DUP),action4 (DUP), action20 (DUP),action21 (DUP),action17

GTT-ASET table is (4 of 20000) 1% full.

If error message “E3557 Cmd Rej: EGTT must be ON before this command can be entered” is displayed, this procedure cannot be performed.

If error message “E3557 Cmd Rej: EGTT must be ON before this command can be entered” is displayed, and the `rtrv-gttaset` output contains no entries, this procedure cannot be performed.

If error message “E3557 Cmd Rej: EGTT must be ON before this command can be entered” is not displayed and entries are displayed in the `rtrv-gttaset` output, continue the procedure by performing one of these steps.

- If all the new ACTID entries for the GTT action set are shown in the `rtrv-gttaset` output, continue the procedure with 3.
 - If any of the new ACTID entries for the GTT action set are not shown in the `rtrv-gttaset` output, continue the procedure with 2.
2. Display the GTT action entries in the database by entering the `rtrv-gttact` command.

This is an example of the possible output.

```
rlghncxa03w 10-07-07 00:28:31 GMT EAGLE5 42.0.0
```

```
ACTID      ACTION    ATCAPERR  ITCAPERR  UDTSEERR  UIMREQD
-----
action2    disc      ---       ---       ---       off
action10   disc      ---       ---       ---       off
action11   disc      ---       ---       ---       on
action15   udts      ---       ---       7         off
action16   tcaperr   0         0         ---       off
action17   tcaperr   10        20        ---       off
```

```
ACTID      ACTION    PCA          RI  SSN  MRNSET  MAPSET
-----
---
action1    dup      002-002-002  gt  ---  DFLT    -----
          CDGTMODID = -----  CGGTMODID = -----
          LOOPSET = None
          USEICMSG = off    CGPCOGMSG = dflt    CGPCA = ---
action3    dup      002-002-002  gt  ---  DFLT    -----
          CDGTMODID = modid2  CGGTMODID = -----
          LOOPSET = None
          USEICMSG = off    CGPCOGMSG = dflt    CGPCA = ---
action4    dup      002-002-002  gt  ---  DFLT    -----
          CDGTMODID = -----  CGGTMODID = modid2
          LOOPSET = None
          USEICMSG = off    CGPCOGMSG = dflt    CGPCA = ---
action20   dup      002-002-002  gt  ---  DFLT    -----
          CDGTMODID = -----  CGGTMODID = -----
          LOOPSET = None
          USEICMSG = off    CGPCOGMSG = dflt    CGPCA = ---
action21   dup      002-002-002  ssn 50  ----  DFLT
          CDGTMODID = -----  CGGTMODID = -----
          LOOPSET = None
          USEICMSG = off    CGPCOGMSG = dflt    CGPCA = ---
action22   fwd      002-002-002  ssn 50  ----  DFLT
          CDGTMODID = -----  CGGTMODID = -----
          LOOPSET = None    DEFACTID = Fallback
          USEICMSG = off    CGPCOGMSG = dflt    CGPCA = ---
action23   fwd      002-002-002  gt  ---  DFLT    -----
          CDGTMODID = -----  CGGTMODID = -----
          LOOPSET = None    DEFACTID = Fallback
```

```

        USEICMSG = off      CGPCOGMSG = dflt      CGPCA = ---
action24  fwd      002-002-002  gt  ---  NONE  -----
        CDGTMODID = -----  CGGTMODID = -----
        LOOPSET = None      DEFACTID = Fallback
        USEICMSG = off      CGPCOGMSG = dflt      CGPCA = ---
action25  fwd      002-002-002  gt  ---  NONE  -----
        CDGTMODID = -----  CGGTMODID = -----
        LOOPSET = None      DEFACTID = Fallback
        USEICMSG = off      CGPCOGMSG = dflt      CGPCA = ---

```

```

ACTID      ACTION  PCI          RI  SSN  MRNSET  MAPSET
-----

```

```

ACTID      ACTION  PCN          RI  SSN  MRNSET  MAPSET
-----

```

```

ACTID      ACTION  PCN24        RI  SSN  MRNSET  MAPSET
-----

```

GTT-ACT table is (15 of 2000) 1% full.

If the required GTT actions are shown in the `rtrv-gttact` output, continue the procedure with [3](#).

If the required GTT actions are not shown in the `rtrv-gttact` output, perform the [Adding a GTT Action](#) procedure to add the required GTT actions to the database. After the [Adding a GTT Action](#) procedure has been performed, continue the procedure with [3](#).

3. Change the GTT action set using the `chg-gttaset` command.

A GTT action set can contain these combinations of GTT actions.

- A GTT action set can contain a maximum of six GTT actions.
- The GTT action set can contain one GTT action whose ACT value is either `disc`, `udts`, `tcaperr`, or `fwd`.
- If the ACT value one of the GTT actions in the GTT action set is `fwd`, the ACT values of the other GTT actions in the GTT action set can only be `dup`.
- The GTT action set can contain a maximum of five GTT actions whose ACT value is `dup`.
- GTT actions whose ACT value is `disc`, `udts`, `tcaperr`, or `fwd` must be the last entry in the GTT action set.
- All the ACTID values in the GTT action set must be unique.

if the name of the GTT action set will be changed with the `nactsn` parameter, the `nactsn` parameter value cannot be `none`. When the GTT action set name is changed, all references to the current GTT action set name are changed to the new GTT action set name.

For this example, enter this command.

```
chg-
gttaset:actsn=act2:nactsn=act10:actid1=action20:actid2=action
1:actid2=action4 :actid3=action21:actid4=action25:on=testmode
```

When this command has successfully completed, this message should appear.

```
rlghncxa03w 10-07-07 00:29:31 GMT EAGLE5 42.0.0
```

```
GTT-ASET table is (4 of 20000) 1% full.
```

```
CHG-GTTASET: MASP A - COMPLTD
```

If the `on=testmode` parameter is specified, this message appears in the output of the `chg-gttaset` command in addition to the other information that is displayed.

```
WARNING: Processing of traffic shall be affected when testmode is ON
```

4. Verify the changes using the `rtrv-gttaset` command with the current name of the GTT action set that was changed, if the name the GTT action set was not changed in 3, or the new name of the GTT action set if the name of the GTT action set was changed in 3.

For this example, enter this command.

```
rtrv-gttaset:actsn=act10
```

The following is an example of the possible output.

```
rlghncxa03w 10-07-07 00:27:31 GMT EAGLE5 42.0.0
```

```
ACTSN      TEST  ActIds
          MODE
-----
act10      on    action20 (DUP),action4 (DUP),action21 (DUP),
          action25 (FWD),-----,-----
```

```
GTT-ASET table is (4 of 20000) 1% full.
```

5. Back up the new changes using the `chg-db:action=backup:dest=fixed` command.

These messages should appear, the active Maintenance and Administration Subsystem Processor (MASP) appears first.

```
BACKUP (FIXED) : MASP A - Backup starts on active MASP.
BACKUP (FIXED) : MASP A - Backup on active MASP to fixed disk
complete.
BACKUP (FIXED) : MASP A - Backup starts on standby MASP.
BACKUP (FIXED) : MASP A - Backup on standby MASP to fixed disk
complete.
```

Figure 4-64 Change a GTT Action Set - Sheet 1 of 2

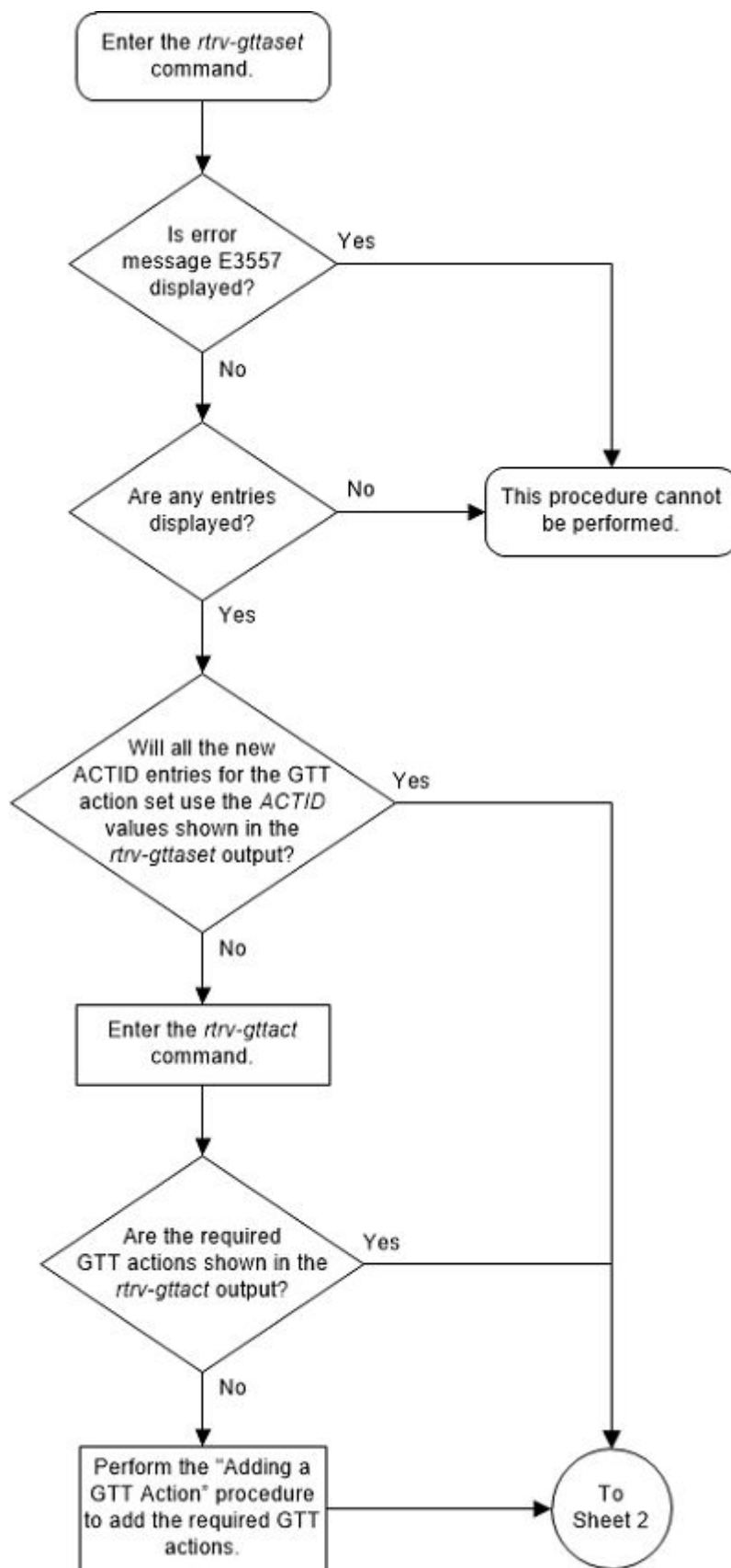
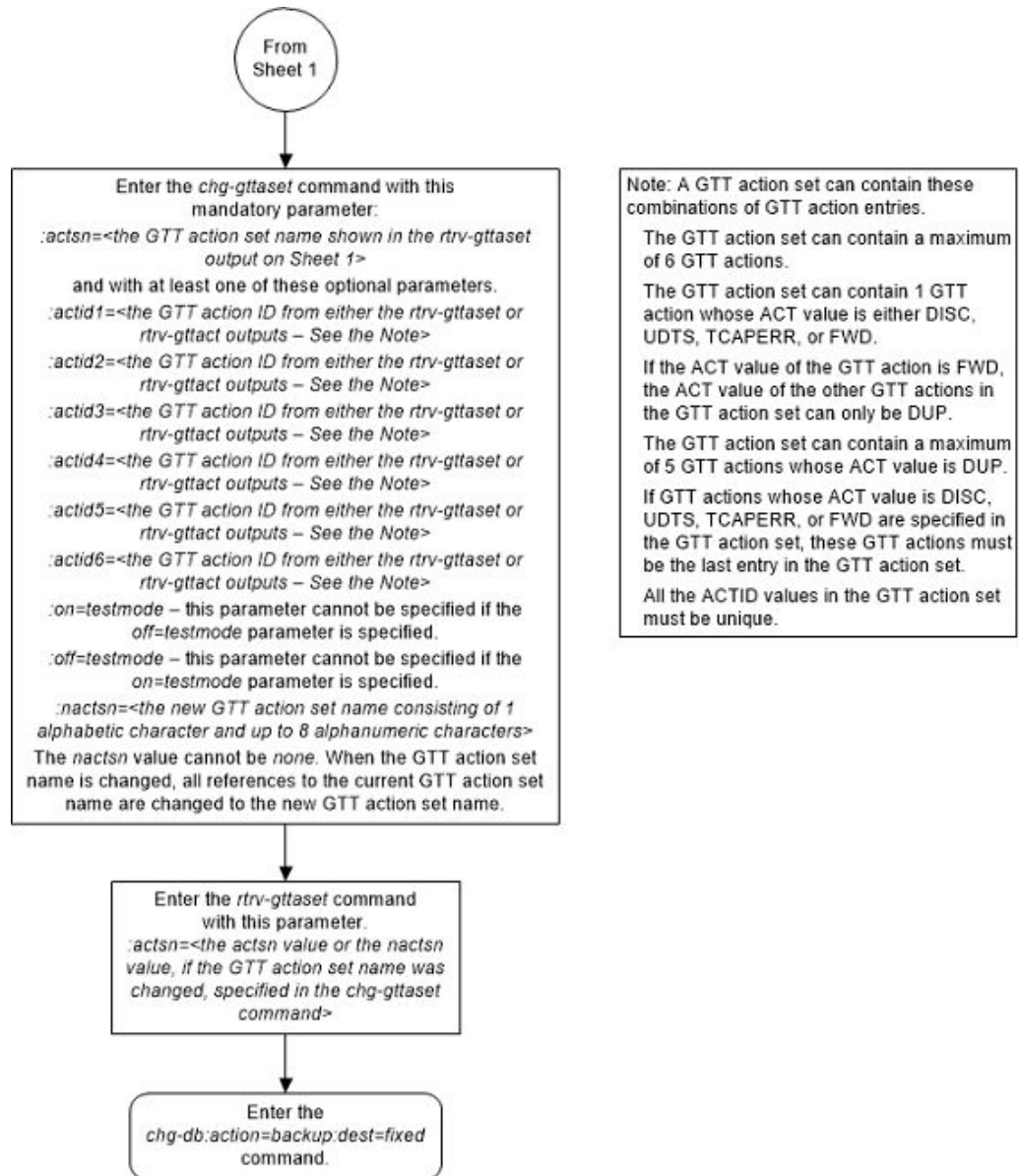

Figure 4-65 Change a GTT Action Set - Sheet 2 of 2



Adding a GTT Action Path Entry

This procedure to add a GTT action path entry to the database using the `ent-gttapath` command.

The `ent-gttapath` command uses these parameters.

`:gttpn` – The name of the GTT action path entry consisting of one alphabetic character followed by up to four alphanumeric characters.

`:cdgttsn` – The name of the GTT set whose SETTYPE value is CDGTA.

`:cdgta` – The GTA value in the GTA entry shown in the `rtrv-gta` output that is assigned to the CDGTA GTT set.

- :cggtsn – The name of the GTT set whose SETTYPE value is CGGTA.
- :cggta – The GTA value in the GTA entry shown in the rtrv-gta output that is assigned to the CGGTA GTT set.
- :opgtsn – The name of the GTT set whose SETTYPE value is OPCODE.
- :opcode – The OPCODE value in the GTA entry shown in the rtrv-gta output that is assigned to the OPCODE GTT set.
- acn – The ACN value in the GTA entry shown in the rtrv-gta output that is assigned to the OPCODE GTT set.
- family – The FAMILY value in the GTA entry shown in the rtrv-gta output that is assigned to the OPCODE GTT set.
- pkgtype – The PKGTYPE value in the GTA entry shown in the rtrv-gta output that is assigned to the OPCODE GTT set.

One of the features shown in [Table 4-52](#) must be enabled to add a GTT action path to the database.

Table 4-52 GTT Actions Features Part Numbers

GTT Actions Features	Part Number
GTT Action - DISCARD	893027501
GTT Action - Duplicate	893027601
GTT Action - Forward	893037501

The status of these features is shown in the rtrv-ctrl-feat command output. If the desired feature is not enabled, perform the [Activating the GTT Actions Features](#) procedure to enable the desired feature.

1. Display the GTT action path entries in the database by entering the rtrv-gttapath command. This is an example of the possible output.

```
rlghncxa03w 10-07-07 00:27:31 GMT EAGLE5 42.0.0

GTPN   OPGTTSN           CGGTTSN           CDGTTSN
-----
path1  -----          -----          setans010
      CDGTA = 336684                ECDGTA = 336684

path2  opcode1          cggtset1          -----
      OPCODE = 10   PKGTYPE = any    FAMILY = 20
      CGGTA = 333333                ECGGTA = 333333

path3  -----          cggtset1          -----
      CGGTA = 333333                ECGGTA = 333333

path4  opcode1          -----          -----
      OPCODE = 10   PKGTYPE = any    FAMILY = 20

path5  opcode2          -----          -----
      OPCODE = 30   PKGTYPE = any    ACN = 50
```

```

path6  opcode2          cggset1      setans010
      OPCODE = 30      PKGTYPE = any ACN = 50
      CCGTA = 333333   ECGGTA = 333333
      CDGTA = 336684   ECDGTA = 336684

path7  opcode1          cggset1      setans010
      OPCODE = 10      PKGTYPE = any FAMILY = 20
      CCGTA = 333333   ECGGTA = 333333
      CDGTA = 336684   ECDGTA = 336684

```

GTT-PATH table is (7 of 10000) 1% full.

If error message “E3451 Cmd Rej: Controlled Feature is not enabled” is not displayed and the `rtrv-gttapath` output contains 10,000 entries, this procedure cannot be performed. The database can contain a maximum of 10,000 GTT action sets.

If error message “E3451 Cmd Rej: Controlled Feature is not enabled” is not displayed and the `rtrv-gttapath` output contains less than 10,000 entries, continue the procedure with 2.

If error message “E3451 Cmd Rej: Controlled Feature is not enabled” is displayed, perform the [Activating the GTT Actions Features](#) procedure to enable one or more of the GTT Actions features. After the [Activating the GTT Actions Features](#) procedure has been performed, continue the procedure with 2.

2. Display the GTT sets in the database by entering the `rtrv-gttset` command.

This is an example of the possible output.

```
rlghncxa03w 10-07-07 00:29:31 GMT EAGLE5 42.0.0
```

```

GTTSN      NETDOM  SETTYPE  NDGT
cdgttl1    ansi    CDGTA    6
opcode1    ansi    OPCODE   -
opcode2    itu     OPCODE   -
opcode3    ansi    OPCODE   -
cdssn1     ansi    CDSSN    -
cggta1     ansi    CCGTA    0
cdgttl2    itu     CDGTA    0
cgpc1     ansi    CGPC     -
cgpc2     ansi    CGSSN    -
cgssn2     ansi    CGSSN    -
opc2       ansi    OPC      -
opcode6    itu     OPCODE   -
opcode7    itu     OPCODE   -
cdssn6     itu     CDSSN    -
cdssn7     itu     CDSSN    -
setans010  ansi    CDGTA    6
cggset1    ansi    CCGTA    6

```

GTT-SET table is (17 of 2000) 1% full.

A CDGTA GTT set, CGGTA GTT set, or OPCODE GTT set must be specified for the GTT action path.

If the desired GTT sets are not shown in the `rtrv-gttset` output, perform the [Adding a GTT Set](#) procedure to add the required GTT sets. After the required GTT sets have been added, perform the [Adding Global Title Address Information](#) procedure to add the GTA entries with the information required for the GTT action path.

If all the desired information for the GTT action path entry was added to the database by performing the [Adding a GTT Set](#) and the [Adding Global Title Address Information](#) procedures, continue the procedure with [4](#).

If any of the GTT sets shown in the `rtrv-gttset` output will be used for the GTT action path entry, continue the procedure with [3](#).

3. Display the GTA entries that are associated with the GTT set shown in [2](#) by entering the `rtrv-gta` command with the name of the GTT set.

For this example enter these commands.

```
rtrv-gta:gttsn=cdgtt1
```

This is an example of the possible output.

```
rlghncxa03w 10-07-07 00:29:31 GMT EAGLE5 42.0.0
```

```
GTTSN      NETDOM  SETTYPE  NDGT
cdgtt1     ansi    CGGTA    6
```

GTA table is (14 of 269999) 1% full.

```
START GTA END GTA  XLAT  RI    PC
919460   919460  DPC   SSN   002-002-002
          SSN=--- CCGT=no CGGTMOD=NO
          GTMODID=----- TESTMODE=off
          LOOPSET = none      FALLBACK=sysdflt CGCNVSN=-----
          OPTSN=----- CGSELID=----- CDSSELID=-----
          ACTSN=----- PPMEASREQD= NO
```

```
rtrv-gta:gttsn=opcode6
```

This is an example of the possible output.

```
rlghncxa03w 10-07-07 00:29:31 GMT EAGLE5 42.0.0
```

```
GTTSN      NETDOM  SETTYPE  NDGT
opcode6    itu     OPCODE   -
```

GTA table is (14 of 269999) 1% full.

```
FAMILY                                OPCODE  PKGTYPE  XLAT  RI    PC
ACN                                    OPCODE  PKGTYPE  XLAT  RI    PC
60                                     90      any      DPC   SSN   2-002-2
          SSN=--- CCGT=no CGGTMOD=NO
```

```
GTMODID=----- TESTMODE=off
LOOPSET = none     FALLBACK=sysdf1t CGCNVSN=-----
OPTSN=----- CGSELID=----- CDSELID=----- OPCS=-----
ACTSN=----- PPMEASREQD= NO
```

Command Retrieved 1 Entries

If a CDGTA GTT set will be specified for the GTT action path entry (the GTT action path `cdgttsn` parameter value), a value must be in the `GTA` column of a GTA entry (the GTT action path `cdgta` parameter value) that is assigned to the CDGTA GTT set.

If a CGGTA GTT set will be specified for the GTT action path entry (the GTT action path `cggtsn` parameter value), a value must be in the `GTA` column of a GTA entry (the GTT action path `cggta` parameter value) that is assigned to the CGGTA GTT set.

If an OPCODE GTT set will be specified for the GTT action path entry (the GTT action path `opgttsn` parameter value), these values must be in the GTA entry that is assigned to the OPCODE GTT set.

- GTT action path OPCODE value must be in the `OPCODE` column of the GTA entry.
- GTT action path ACN value must be in the `ACN` column of an ITU GTA entry.
- GTT action path FAMILY value must be in the `FAMILY` column of an ANSI GTA entry.
- GTT action path PKGTYPE value must be in the `PKGTYPE` column of the GTA entry.

If the required information for the GTT action path entry is shown in the `rtrv-gta` output, continue the procedure with [4](#).

if the required information for the GTT action path entry is not shown in the `rtrv-gta` output, continue the procedure by performing one of these steps.

- If other GTT sets of the set type that you wish to use for the GTT action path entry are shown in the [2](#) and you wish to use one of these GTT sets, repeat this step with the name of the GTT set shown in [2](#).
- If other GTT sets of the set type that you wish to use for the GTT action path entry are not shown in the [2](#), add the required information for the GTT action path entry by performing the [Adding Global Title Address Information](#) procedure with the name of the GTT set that was specified in this step. After the [Adding Global Title Address Information](#) procedure has been performed, continue the procedure with [4](#).

4. Add the GTT action path entry to the database using the `ent-gttapath` command with these parameters.

If a CDGTA GTT set will be specified for the GTT action path entry, specify these parameters.

- `cdgttsn` - the name of the GTT set shown in [2](#) or provisioned with the [Adding a GTT Set](#) procedure whose `SETTYPE` value is CDGTA.
- `cdgta` - the GTA value shown in [3](#) or provisioned with the [Adding Global Title Address Information](#) procedure. The GTA entry must be associated with the `cdgttsn` parameter value.

If a CGGTA GTT set will be specified for the GTT action path entry, specify these parameters.

- `cggttsn` - the name of the GTT set shown in 2 or provisioned with the [Adding a GTT Set](#) procedure whose `SETTYPE` value is CGGTA.
- `cggta` - the GTA value shown in 3 or provisioned with the [Adding Global Title Address Information](#) procedure. The GTA entry must be associated with the `cggttsn` parameter value.

If an OPCODE GTT set will be specified for the GTT action path entry, specify these parameters.

- `opgttsn` - the name of the GTT set shown in 2 or provisioned with the [Adding a GTT Set](#) procedure whose `SETTYPE` value is CDGTA.
- If the OPCODE GTA entry is an ANSI OPCODE GTA entry, specify the `family` and `pkgtype` parameters and values shown in 3 or provisioned with the [Adding Global Title Address Information](#) procedure. The GTA entry must be associated with the `opgttsn` parameter value.
- If the OPCODE GTA entry is an ITU OPCODE GTA entry, specify the `acn` and `pkgtype` parameters and values shown in 3 or provisioned with the [Adding Global Title Address Information](#) procedure. The GTA entry must be associated with the `opgttsn` parameter value.

For this example, enter these commands.

```
ent-gttapath:gttpn=pth10:cdgttsn=cdgtt1:cdgta=919460
ent-
gttapath:gttpn=pth11:cdgttsn=cdgtt1:cdgta=919460:cggttsn=cggt
a1:cggta=800555
ent-
gttapath:gttpn=pth12:cdgttsn=cdgtt1:cdgta=919460:cggttsn=cggt
a1:cggta=800555 :opgttsn=opccode11:opcode=100:family=20:pkgty
pe=any
ent-
gttapath:gttpn=pth13:opgttsn=opcode6:opcode=60:acn=90:pkgtype
=any
```

When each of these commands have successfully completed, this message should appear.

```
rlghncxa03w 10-07-07 00:29:31 GMT EAGLE5 42.0.0
GTT-PATH table is (11 of 10000) 1% full.
ENT-GTTAPATH: MASP A - COMPLTD
```

5. Verify the changes using the `rtrv-gttapath` command with the `gttpn` parameter and value specified in 4.

For this example, enter these commands.

```
rtrv-gttapath:gttpn=pth10
rlghncxa03w 10-07-07 00:30:31 GMT EAGLE5 42.0.0
```

```

GTPN   OPGTTSN           CGGTTSN           CDGTTSN
-----
pth10  -----           -----           cdgttl
      CDGTA = 919460                ECDGTA = 919460

```

GTT-PATH table is (11 of 10000) 1% full.

rtrv-gttapath:gttpn=pth11

rlghncxa03w 10-07-07 00:30:31 GMT EAGLE5 42.0.0

```

GTPN   OPGTTSN           CGGTTSN           CDGTTSN
-----
pth11  -----           cggtal           cdgttl
      CGGTA = 800555                ECGGTA = 800555
      CDGTA = 919460                ECDGTA = 919460

```

GTT-PATH table is (11 of 10000) 1% full.

rtrv-gttapath:gttpn=pth12

rlghncxa03w 10-07-07 00:30:31 GMT EAGLE5 42.0.0

```

GTPN   OPGTTSN           CGGTTSN           CDGTTSN
-----
pth12  opccode11         cggtal           cdgttl
      OPCODE = 100   PKGTYPE = any   FAMILY = 20
      CGGTA = 800555                ECGGTA = 800555
      CDGTA = 919460                ECDGTA = 919460

```

GTT-PATH table is (11 of 10000) 1% full.

rtrv-gttapath:gttpn=pth13

rlghncxa03w 10-07-07 00:30:31 GMT EAGLE5 42.0.0

```

GTPN   OPGTTSN           CGGTTSN           CDGTTSN
-----
pth13  opcode6             -----           -----
      OPCODE = 60   PKGTYPE = any   ACN = 90

```

GTT-PATH table is (11 of 10000) 1% full.

6. Backup the new changes using the `chg-db:action=backup:dest=fixed` command. These messages should appear, the active Maintenance and Administration Subsystem Processor (MASP) appears first.

```
BACKUP (FIXED) : MASP A - Backup starts on active MASP.  
BACKUP (FIXED) : MASP A - Backup on active MASP to fixed disk  
complete.  
BACKUP (FIXED) : MASP A - Backup starts on standby MASP.  
BACKUP (FIXED) : MASP A - Backup on standby MASP to fixed disk  
complete.
```

Figure 4-66 Add a GTT Action Path Entry - Sheet 1 of 3

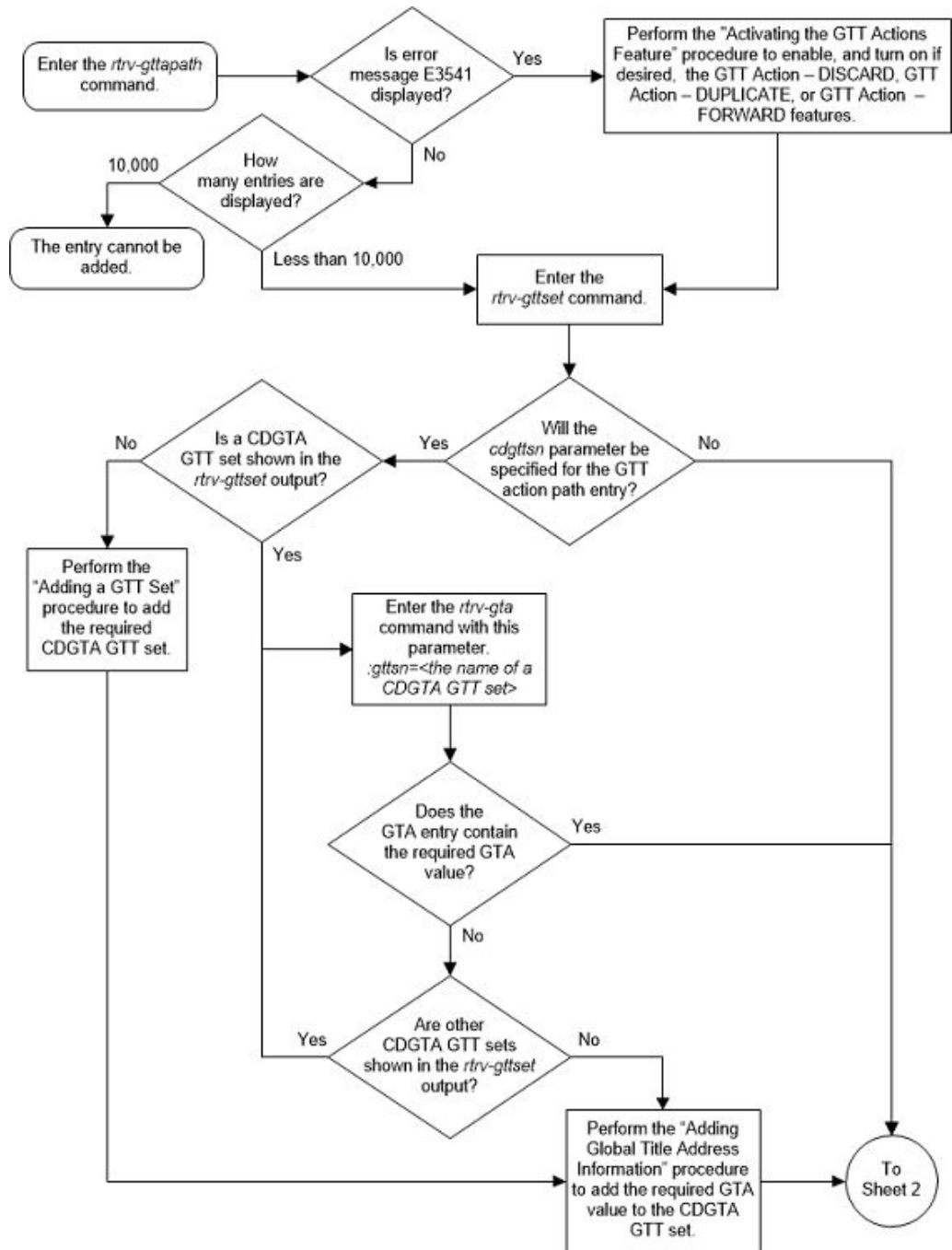

Figure 4-67 Add a GTT Action Path Entry - Sheet 2 of 3

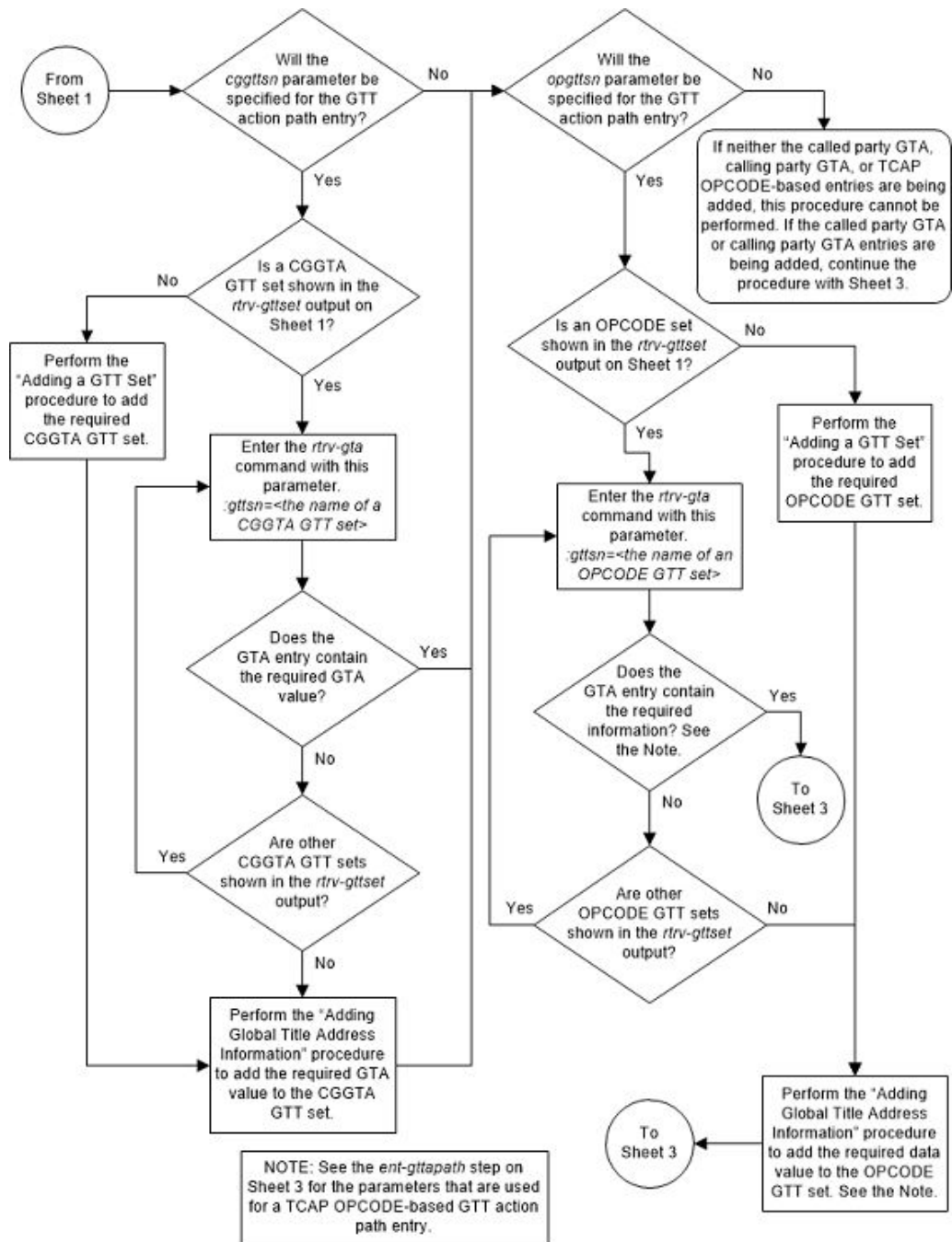
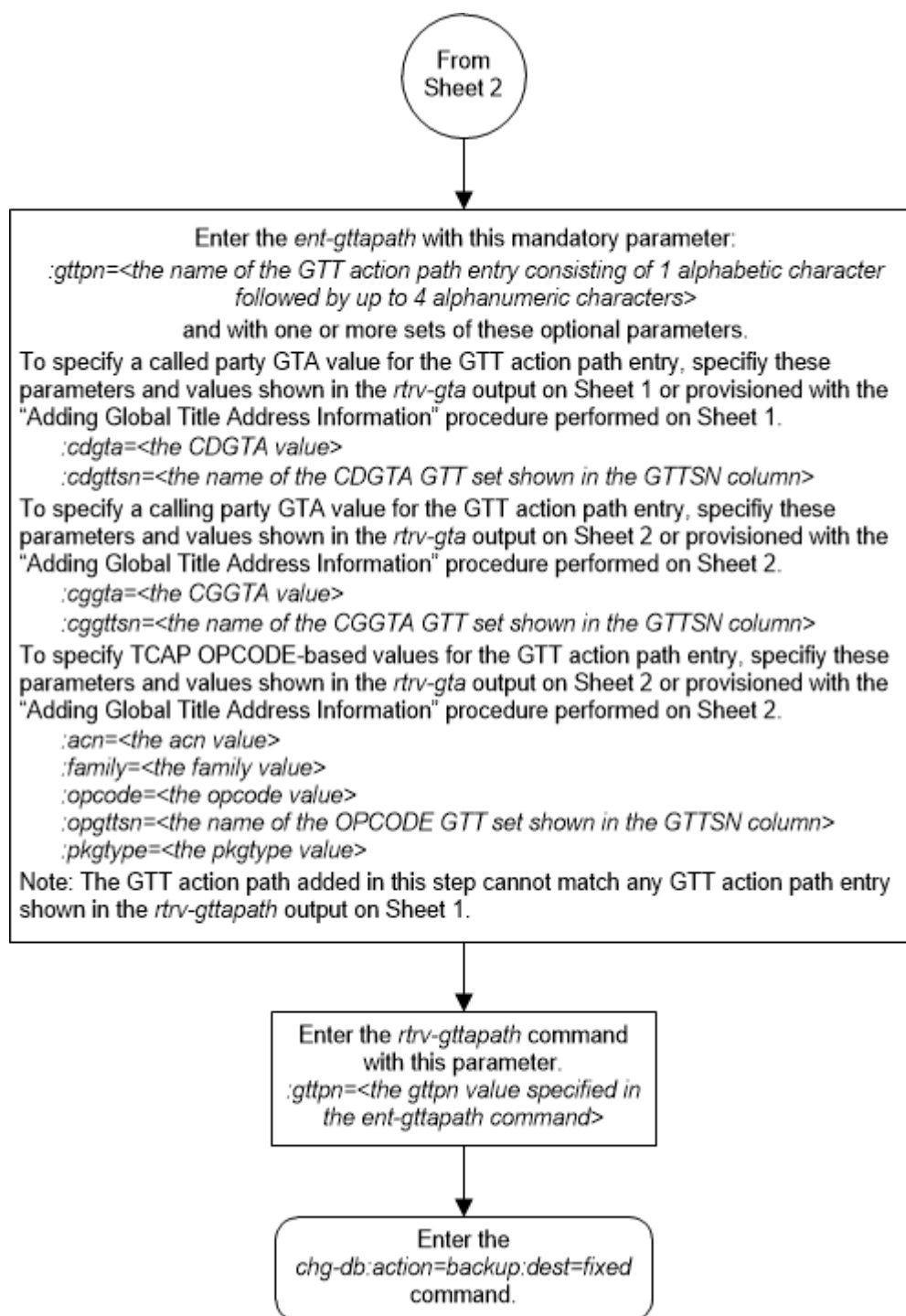

Figure 4-68 Add a GTT Action Path Entry - Sheet 3 of 3



Removing a GTT Action Path Entry

This procedure is used to remove a GTT action path entry from the database using the *dlt-gttapath* command.

The `dlt-gttapath` command uses this parameter.

`:gttpn` – The name of the GTT action path entry as shown in the `rtrv-gttapath` output.

1. Display the existing GTT action path entries in the database by entering the `rtrv-gttapath` command.

This is an example of the possible output.

```
rlghncxa03w 10-07-07 00:27:31 GMT EAGLE5 42.0.0

GTPPN      OPGTTSN          CGGTTSN          CDGTTSN
-----
path1      -----          -----          setans010
          CDGTA = 336684          ECDGTA = 336684

path2      opcode1          cggtsset1        -----
          OPCODE = 10          PKGTYPE = any          FAMILY = 20
          CGGTA = 333333          ECGGTA = 333333

path3      -----          cggtsset1        -----
          CGGTA = 333333          ECGGTA = 333333

path4      opcode1          -----          -----
          OPCODE = 10          PKGTYPE = any          FAMILY = 20

path5      opcode2          -----          -----
          OPCODE = 30          PKGTYPE = any          ACN = 50

path6      opcode2          cggtsset1        setans010
          OPCODE = 30          PKGTYPE = any          ACN = 50
          CGGTA = 333333          ECGGTA = 333333
          CDGTA = 336684          ECDGTA = 336684

path7      opcode1          cggtsset1        setans010
          OPCODE = 10          PKGTYPE = any          FAMILY = 20
          CGGTA = 333333          ECGGTA = 333333
          CDGTA = 336684          ECDGTA = 336684
```

GTT-PATH table is (7 of 10000) 1% full.

If no entries are displayed in this step, this procedure cannot be performed.

If entries are displayed in this step, continue the procedure with [2](#).

2. Remove the GTT action path entry from the database by entering the `dlt-gttapath` command with the name of the GTT action path entry that will be removed.

For this example, enter this command.

```
dlt-gttapath:gttpn=path7
```

When the command has successfully completed, this message should appear:

```
rlghncxa03w 09-07-07 00:29:31 GMT EAGLE5 41.1.0  
  
GTT-PATH table is (6 of 10000) 1% full.  
  
DLT-GTTAPATH: MASP A - COMPLTD
```

3. Verify the changes using the `rtrv-gttapath` command with the `gttpn` parameter value specified in 2.

For this example, enter this command.

```
rtrv-gttapath:gttpn=path7
```

The following message is displayed.

```
E5378 Cmd Rej: Specified path name doesn't exist
```

4. Backup the new changes using the `chg-db:action=backup:dest=fixed` command.

These messages should appear, the active Maintenance and Administration Subsystem Processor (MASP) appears first.

```
BACKUP (FIXED) : MASP A - Backup starts on active MASP.  
BACKUP (FIXED) : MASP A - Backup on active MASP to fixed disk  
complete.  
BACKUP (FIXED) : MASP A - Backup starts on standby MASP.  
BACKUP (FIXED) : MASP A - Backup on standby MASP to fixed disk  
complete.
```

Figure 4-69 Remove a GTT Action Path Entry

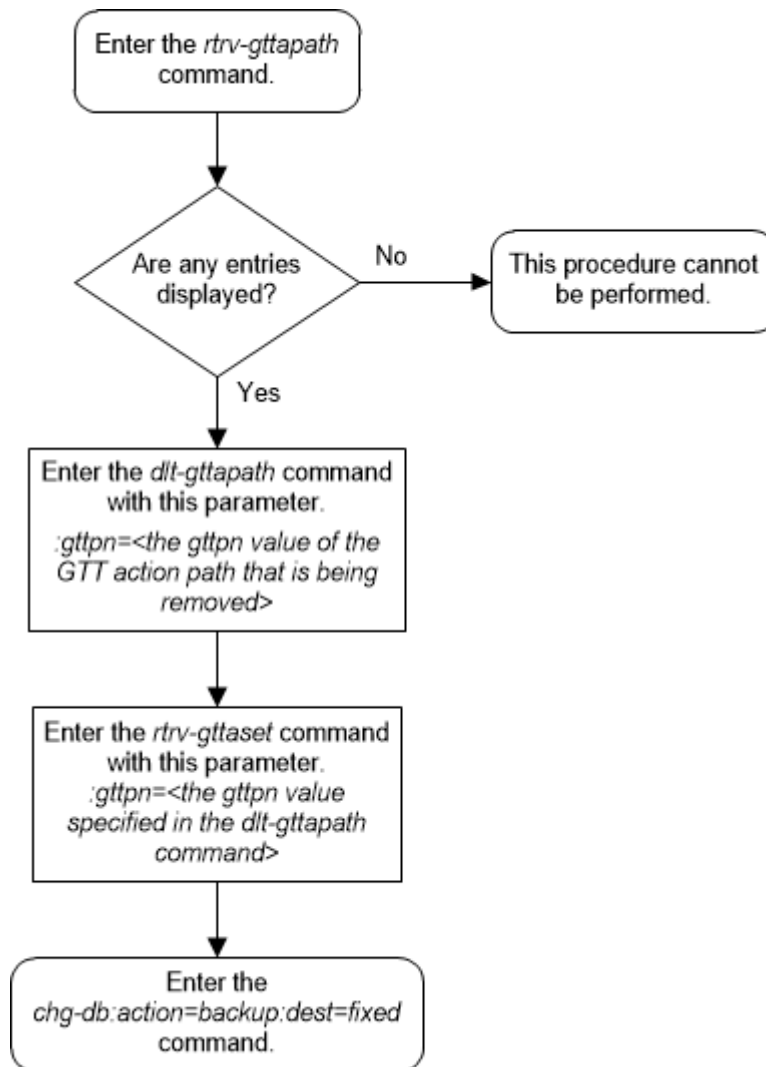

Changing a GTT Action Path Entry

This procedure is used to change the attributes of a GTT action path entry using the `chg-gttapath` command.

The `chg-gttapath` command uses these parameters.

`:gttpn` – The current name of the GTT action path entry shown in the `rtrv-gttapath` output.

`:ngttn` – The new name of the GTT action path entry consisting of one alphabetic character followed by up to four alphanumeric characters.

`:cdgttsn` – The name of the GTT set whose `SETTYPE` value is `CDGTA`.

`:cdgta` – The `GTA` value in the `GTA` entry shown in the `rtrv-gta` output that is assigned to the `CDGTA` GTT set.

:cggtsn – The name of the GTT set whose SETTYPE value is CGGTA.

:cggta – The GTA value in the GTA entry shown in the rtrv-gta output that is assigned to the CGGTA GTT set.

:opgtsn – The name of the GTT set whose SETTYPE value is OPCODE.

:opcode – The OPCODE value in the GTA entry shown in the rtrv-gta output that is assigned to the OPCODE GTT set.

acn – The ACN value in the GTA entry shown in the rtrv-gta output that is assigned to the OPCODE GTT set.

family – The FAMILY value in the GTA entry shown in the rtrv-gta output that is assigned to the OPCODE GTT set.

pkgtype – The PKGTYPE value in the GTA entry shown in the rtrv-gta output that is assigned to the OPCODE GTT set.

1. Display the existing GTT action path entries in the database using the rtrv-gttapath command. This is an example of the possible output.

```
rlghncxa03w 10-07-07 00:27:31 GMT EAGLE5 42.0.0
```

GTPN	OPGTSN	CGGTSN	CDGTSN
path1	-----	-----	setans010
	CDGTA = 336684		ECDGTA = 336684
path2	opcode1	cggtsn1	-----
	OPCODE = 10	PKGTYPE = any	FAMILY = 20
	CGGTA = 333333		ECGGTA = 333333
path3	-----	cggtsn1	-----
	CGGTA = 333333		ECGGTA = 333333
path4	opcode1	-----	-----
	OPCODE = 10	PKGTYPE = any	FAMILY = 20
path5	opcode2	-----	-----
	OPCODE = 30	PKGTYPE = any	ACN = 50
path6	opcode2	cggtsn1	setans010
	OPCODE = 30	PKGTYPE = any	ACN = 50
	CGGTA = 333333		ECGGTA = 333333
	CDGTA = 336684		ECDGTA = 336684
path7	opcode1	cggtsn1	setans010
	OPCODE = 10	PKGTYPE = any	FAMILY = 20
	CGGTA = 333333		ECGGTA = 333333
	CDGTA = 336684		ECDGTA = 336684
pth10	-----	-----	cdgtal
	CDGTA = 919460		ECDGTA = 919460
pth11	-----	cggtsn1	cdgtal

```

CGGTA = 800555          ECGGTA = 800555
CDGTA = 919460        ECDGTA = 919460

pth12  opcode11        cggtal          cdgtal
      OPCODE = 100    PKGTYPE = any    FAMILY = 20
      CGGTA = 800555    ECGGTA = 800555
      CDGTA = 919460    ECDGTA = 919460

pth13  opcode12        -----          -----
      OPCODE = 70     PKGTYPE = any    ACN = 40

```

GTT-PATH table is (11 of 10000) 1% full.

If error message “E3451 Cmd Rej: Controlled Feature is not enabled” is displayed, this procedure cannot be performed as there are no entries to change.

If error message “E3451 Cmd Rej: Controlled Feature is not enabled” is not displayed continue the procedure with 2.

2. Display the GTT sets in the database by entering the `rtrv-gttset` command.

This is an example of the possible output.

```
rlghncxa03w 10-07-07 00:29:31 GMT EAGLE5 42.0.0
```

GTTSN	NETDOM	SETTYPE	NDGT
cdgtt1	ansi	CDGTA	6
opcode1	ansi	OPCODE	-
opcode2	itu	OPCODE	-
opcode3	ansi	OPCODE	-
cdssn1	ansi	CDSSN	-
cggtal	ansi	CGGTA	0
cdgtt2	itu	CDGTA	0
cgpc1	ansi	CGPC	-
cgpc2	ansi	CGSSN	-
cgssn2	ansi	CGSSN	-
opc2	ansi	OPC	-
opcode6	itu	OPCODE	-
opcode7	itu	OPCODE	-
cdssn6	itu	CDSSN	-
cdssn7	itu	CDSSN	-
setans010	ansi	CDGTA	6
cggtset1	ansi	CGGTA	6
cggtal3	ansi	CGGTA	6

GTT-SET table is (17 of 2000) 1% full.

A CDGTA GTT set, CGGTA GTT set, or OPCODE GTT set must be specified for the GTT action path.

If the desired GTT sets are not shown in the `rtrv-gttset` output, perform the [Adding a GTT Set](#) procedure to add the required GTT sets. After the required GTT sets have been added, perform the [Adding Global Title Address Information](#) procedure to add the GTA entries with the information required for the GTT action path.

If all the desired information for the GTT action path entry was added to the database by performing the [Adding a GTT Set](#) and the [Adding Global Title Address Information](#) procedures, continue the procedure with 4.

If any of the GTT sets shown in the `rtrv-gttset` output will be used for the GTT action path entry, continue the procedure with 3.

3. Display the GTA entries that are associated with the GTT set shown in 2 by entering the `rtrv-gta` command with the name of the GTT set.

For this example enter these commands.

```
rtrv-gta:gttsn=cdgtt1
```

This is an example of the possible output.

```
rlghncxa03w 10-07-07 00:29:31 GMT EAGLE5 42.0.0
```

```
GTTSN      NETDOM  SETTYPE  NDGT
cdgtt1     ansi    CDGTA    6
```

GTA table is (14 of 269999) 1% full.

```
START GTA END GTA  XLAT  RI    PC
919460   919460  DPC    SSN   002-002-002
          SSN=--- CCGT=no CGGTMOD=NO
          GTMODID=----- TESTMODE=off
          LOOPSET = none    FALLBACK=sysdflt CGCNVSN=-----
          OPTSN=----- CGSELID=----- CDSELID=-----
          ACTSN=----- PPMEASREQD= NO
```

```
rtrv-gta:gttsn=cggta3
```

This is an example of the possible output.

```
rlghncxa03w 10-07-07 00:29:31 GMT EAGLE5 42.0.0
```

```
GTTSN      NETDOM  SETTYPE  NDGT
cggta3     ansi    CGGTA    6
```

GTA table is (14 of 269999) 1% full.

```
START GTA END GTA  XLAT  RI    PC
800555   800555  DPC    SSN   002-002-002
          SSN=--- CCGT=no CGGTMOD=NO
          GTMODID=----- TESTMODE=off
          LOOPSET = none    FALLBACK=sysdflt CGCNVSN=-----
          OPTSN=----- CGSELID=----- CDSELID=-----
          ACTSN=----- PPMEASREQD= NO
```

```
rtrv-gta:gttsn=opcode6
```

This is an example of the possible output.

```
rlghncxa03w 10-07-07 00:29:31 GMT EAGLE5 42.0.0
```

```
GTTSN      NETDOM  SETTYPE  NDGT
opcode6    itu      OPCODE   -
```

GTA table is (14 of 269999) 1% full.

```
FAMILY                                OPCODE  PKGTYPE  XLAT  RI  PC
ACN                                    OPCODE  PKGTYPE  XLAT  RI  PC
60                                     90      any      DPC   SSN  2-002-2
    SSN=--- CCGT=no CGGTMOD=NO
    GTMODID=----- TESTMODE=off
    LOOPSET = none    FALLBACK=sysdf1t CGCNVSN=-----
    OPTSN=----- CGSELID=----- CDSELID=----- OPCS=-----
    ACTSN=----- PPMEASREQD= NO
```

Command Retrieved 1 Entries

If a CDGTA GTT set will be specified for the GTT action path entry (the GTT action path `cdgttsn` parameter value), a value must be in the `GTA` column of a GTA entry (the GTT action path `cdgta` parameter value) that is assigned to the CDGTA GTT set.

If a CGGTA GTT set will be specified for the GTT action path entry (the GTT action path `cggtsn` parameter value), a value must be in the `GTA` column of a GTA entry (the GTT action path `cggta` parameter value) that is assigned to the CGGTA GTT set.

If an OPCODE GTT set will be specified for the GTT action path entry (the GTT action path `opgttsn` parameter value), these values must be in the GTA entry that is assigned to the OPCODE GTT set.

- GTT action path OPCODE value must be in the OPCODE column of the GTA entry.
- GTT action path ACN value must be in the ACN column of an ITU GTA entry.
- GTT action path FAMILY value must be in the FAMILY column of an ANSI GTA entry.
- GTT action path PKGTYPE value must be in the PKGTYPE column of the GTA entry.

If the required information for the GTT action path entry is shown in the `rtrv-gta` output, continue the procedure with [4](#).

if the required information for the GTT action path entry is not shown in the `rtrv-gta` output, continue the procedure by performing one of these steps.

- If other GTT sets of the set type that you wish to use for the GTT action path entry are shown in the [2](#) and you wish to use one of these GTT sets, repeat this step with the name of the GTT set shown in [2](#).
- If other GTT sets of the set type that you wish to use for the GTT action path entry are not shown in the [2](#), add the required information for the GTT

action path entry by performing the [Adding Global Title Address Information](#) procedure with the name of the GTT set that was specified in this step. After the [Adding Global Title Address Information](#) procedure has been performed, continue the procedure with 4.

4. Change the GTT action path entry using the `chg-gttapath` command.

For this example, enter this command.

```
chg-
gttapath:gttpn=path7:ngttn=pth20:cdgttsn=cdgtt1:cdgta=919460
:cggttsn=cggtta3 :cggtta=800555:opgttsn=opcode6:acn=60:opcode=9
0:pkgtype=any
```

When this command has successfully completed, this message should appear.

```
rlghncxa03w 10-07-07 00:29:31 GMT EAGLE5 42.0.0
```

```
GTT-PATH table is (11 of 10000) 1% full.
```

```
CHG-GTTAPATH: MASP A - COMPLTD
```

5. Verify the changes using the `rtrv-gttapath` command with the current name of the GTT action path entry that was changed, if the name the GTT action path entry was not changed in 4, or the new name of the GTT action path entry if the name of the GTT action path entry was changed in 4.

For this example, enter this command.

```
rtrv-gttapath:gttpn=pth20
```

The following is an example of the possible output.

```
rlghncxa03w 10-07-07 00:27:31 GMT EAGLE5 42.0.0
```

GTPPN	OPGTTSN	CGGTTSN	CDGTTSN
pth20	opcode6	cggtta3	cdgtt1
	OPCODE = 90	PKGTYPE = any	ACN = 60
	CGGTA = 800555		ECGTA = 800555
	CDGTA = 919460		ECDGTA = 919460

```
GTT-PATH table is (11 of 10000) 1% full.
```

6. Backup the new changes using the `chg-db:action=backup:dest=fixed` command.

These messages should appear, the active Maintenance and Administration Subsystem Processor (MASP) appears first.

```
BACKUP (FIXED) : MASP A - Backup starts on active MASP.
BACKUP (FIXED) : MASP A - Backup on active MASP to fixed disk
complete.
BACKUP (FIXED) : MASP A - Backup starts on standby MASP.
BACKUP (FIXED) : MASP A - Backup on standby MASP to fixed disk
complete.
```

Figure 4-70 Change a GTT Action Path Entry - Sheet 1 of 3

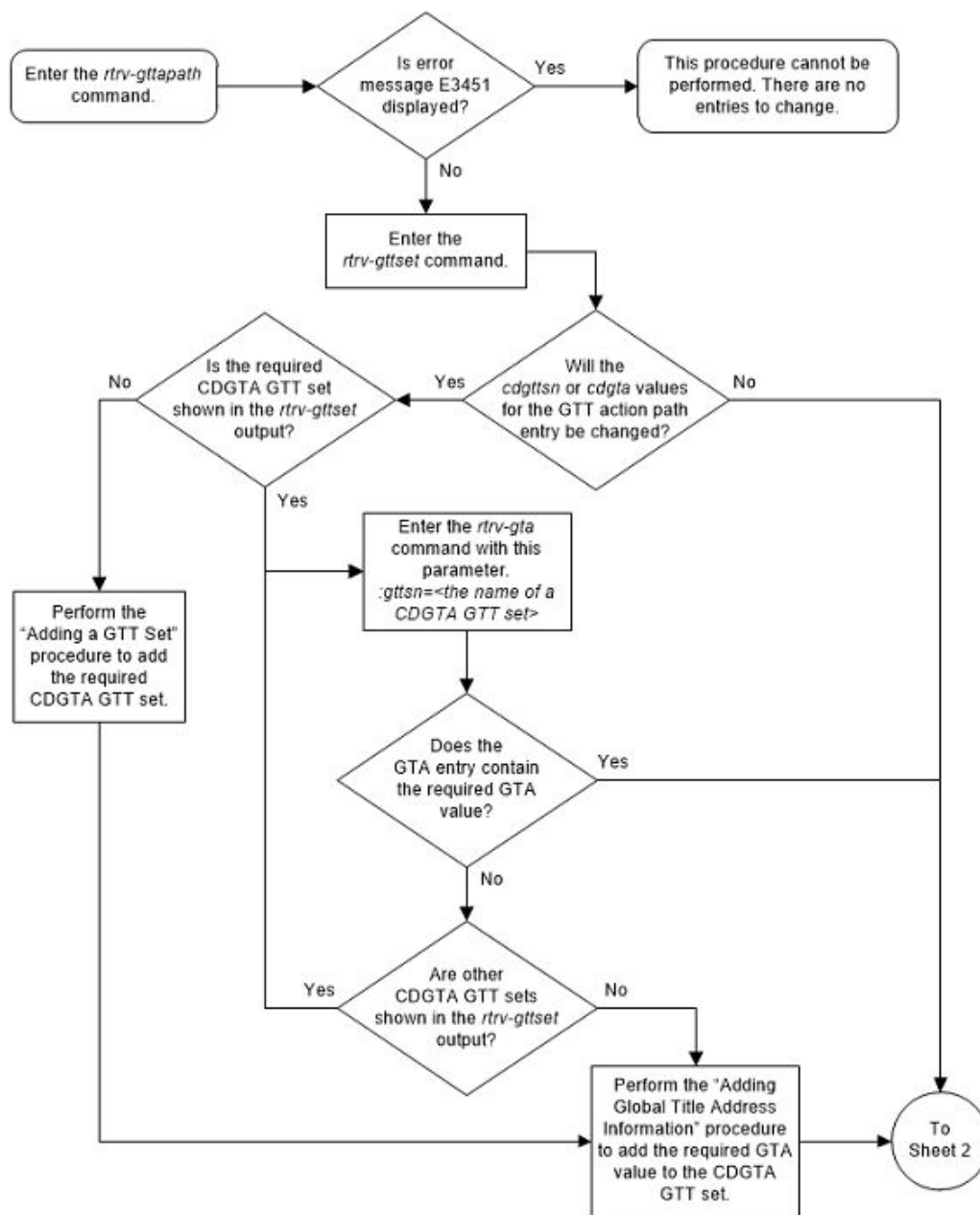

Figure 4-71 Change a GTT Action Path Entry - Sheet 2 of 3

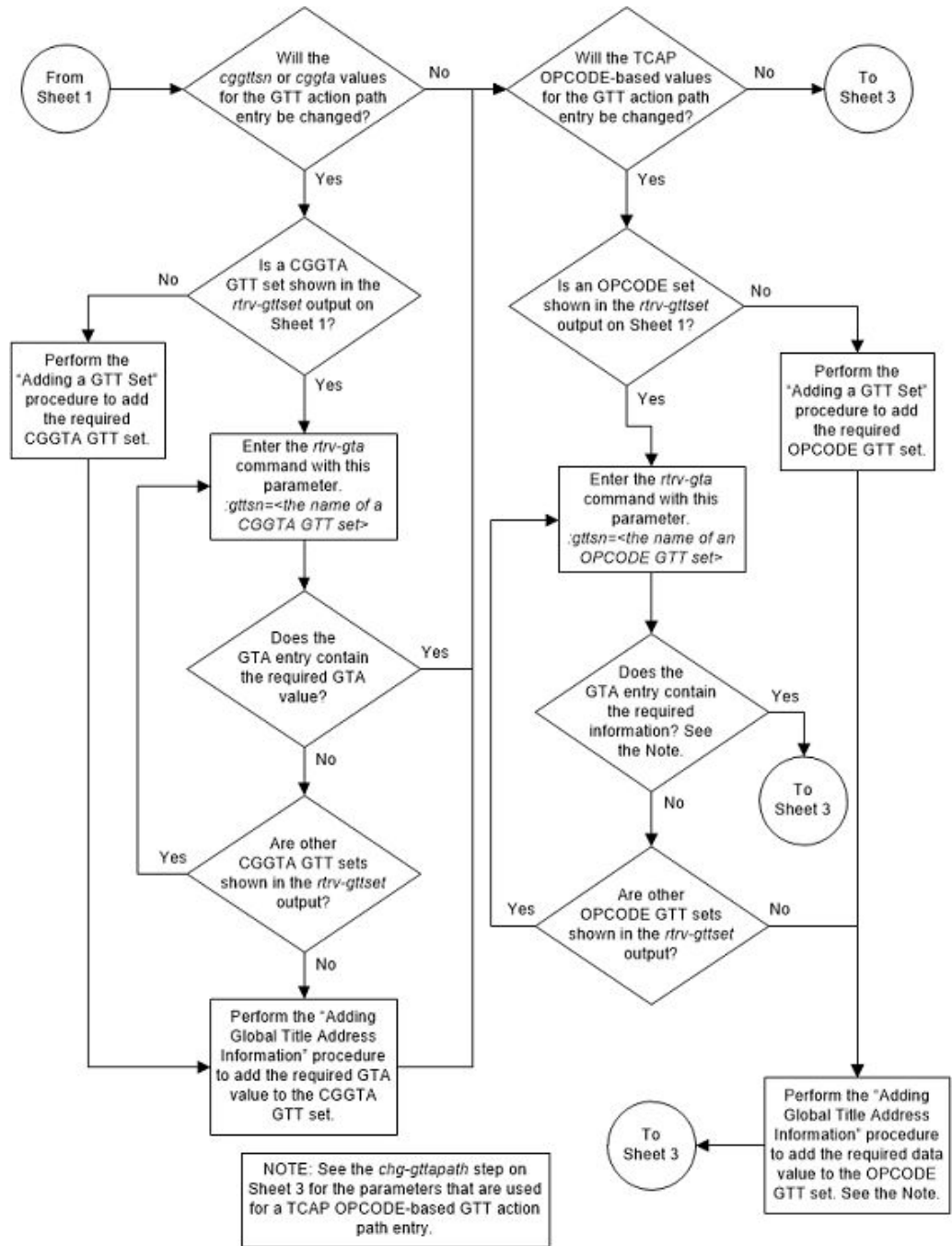
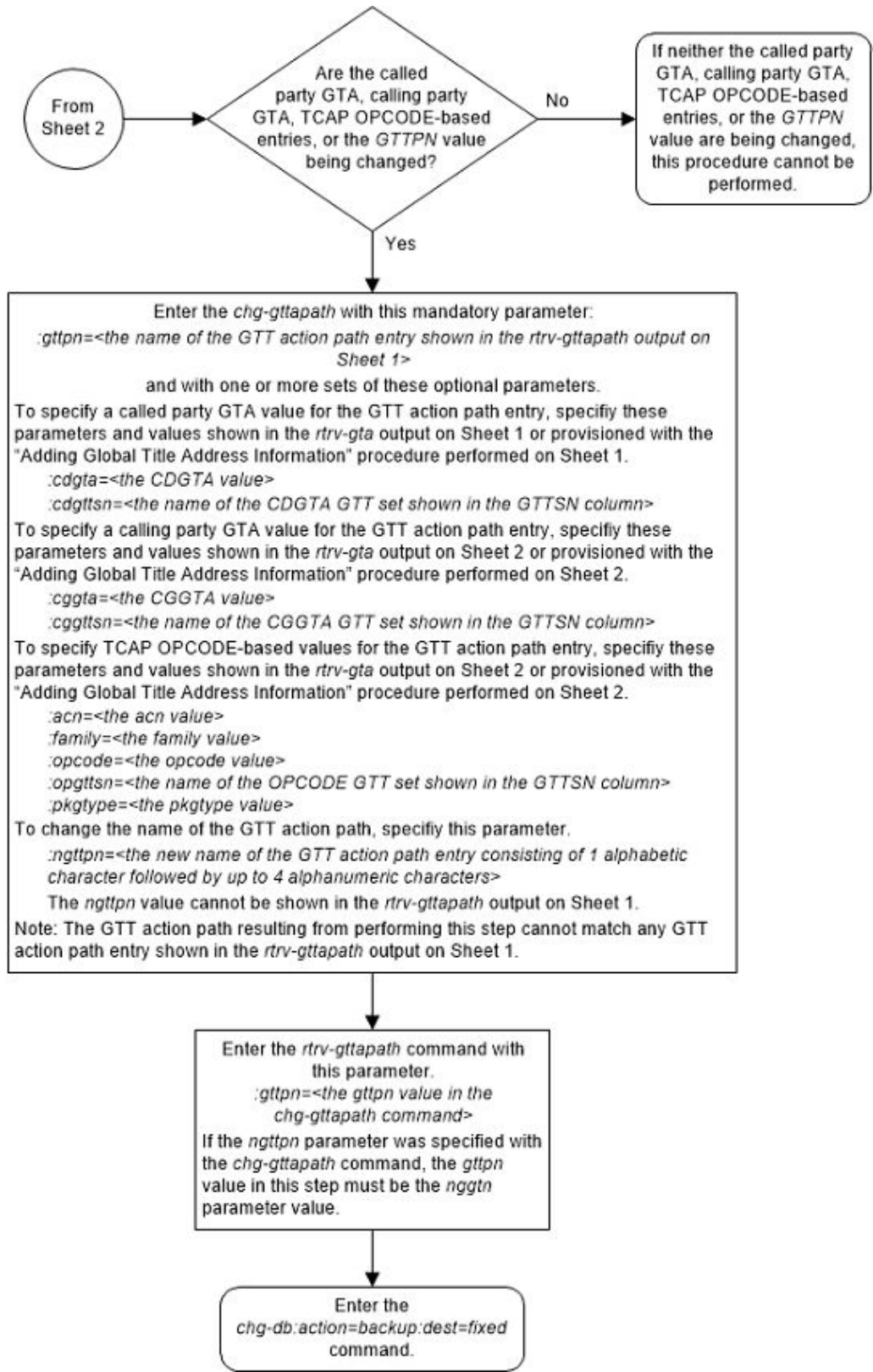

Figure 4-72 Change a GTT Action Path Entry - Sheet 3 of 3



Changing the Unique GTT Selector Option

This procedure is used to change the unique GTT selector option using the `chg-sccpopts` command with this parameter.

`:unqgttsel` – This parameter specifies whether a GTT selector search is performed on overlapped GTT selectors. This parameter has two values.

- `bestmatch` - Overlapped GTT selectors are searched if non-overlapped GTT selectors are not found.
- `exactmatch` - Only non-overlapped GTT selectors are searched.

1. Display the existing unique GTT selector option value by entering the `rtrv-sccpopts` command.

This is an example of the possible output.

```
rlghncxa03w 10-07-17 16:02:05 GMT EAGLE5 42.0.0
```

```
SCCP OPTIONS
```

```
-----  
UNQGTSEL           bestmatch
```

The `rtrv-sccpopts` output contains other fields that are not used in this procedure. If you wish to see these fields, refer to the `rtrv-sccpopts` command description in the *Commands Manual*.

2. Change the unique GTT selector option value by entering the `chg-sccpopts` command with the `unqgttsel` parameter.

For this example, enter this command.

```
chg-sccpopts:unqgttsel=exactmatch
```

When the `chg-sccpopts` command has successfully completed, this message should appear.

```
rlghncxa03w 10-07-07 00:22:57 GMT EAGLE5 42.0.0  
CHG-STPOPTS: MASP A - COMPLTD
```

3. Verify the changes using the `rtrv-sccpopts` command. This is an example of the possible output.

```
rlghncxa03w 10-07-17 16:02:05 GMT EAGLE5 42.0.0
```

```
SCCP OPTIONS
```

```
-----  
UNQGTSEL           exactmatch
```

The `rtrv-sccpopts` output contains other fields that are not used in this procedure. If you wish to see these fields, refer to the `rtrv-sccpopts` command description in *Commands User's Guide*.

4. Back up the new changes using the `chg-db:action=backup:dest=fixed` command. These messages should appear, the active Maintenance and Administration Subsystem Processor (MASP) appears first.

```
BACKUP (FIXED) : MASP A - Backup starts on active MASP.  
BACKUP (FIXED) : MASP A - Backup on active MASP to fixed disk  
complete.  
BACKUP (FIXED) : MASP A - Backup starts on standby MASP.  
BACKUP (FIXED) : MASP A - Backup on standby MASP to fixed disk  
complete.
```

Figure 4-73 Change the Unique GTT Selector Option

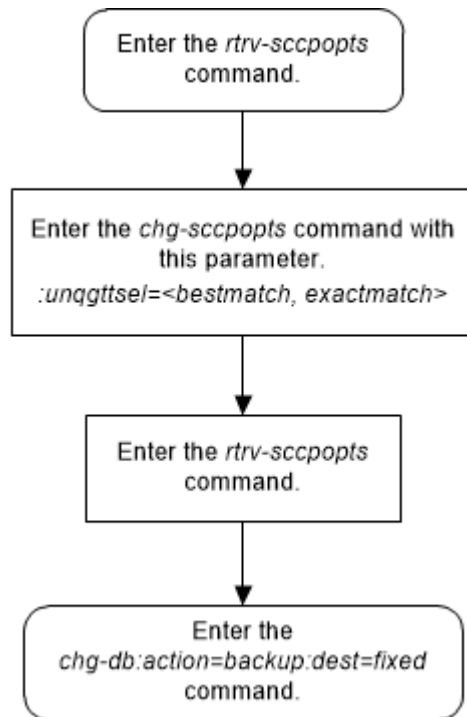

5

Controlled Feature Activation Procedures

Appendix A, Controlled Feature Activation Procedures, describes the procedures necessary to activate and deactivate features (features that require a feature access key to be activated) contained in this user's guide.

Introduction

 **Note:**

As of Release 46.3, the parameter `fake` is no longer required. This parameter is only used for backward compatibility.

Controlled features are features that are activated using a feature access key. These features can either be on or off, or features that operate at a particular performance level. Only the controlled features that are used in this user's guide are covered in this appendix.

The feature access key allows the user to enable and activate a controlled feature in the EAGLE by entering either a permanent feature access key or a temporary feature access key. By requiring a feature access key to enable and activate a controlled feature, unauthorized enabling and activation of a controlled feature can be prevented. The feature access key is supplied by Oracle Communications.

Features enabled with a permanent feature access key remain enabled for as long as the EAGLE remains in service. Once features are permanently enabled, they cannot be disabled.

Features enabled with a temporary feature access key are enabled for only 30 days. On the twenty-third day, seven days before the temporary key expires, a major alarm (UAM 0367) is generated to inform the user that the one or more temporary feature access keys will expire soon.

```
0367.0181  ** SYSTEM      Temp Key(s) expiring soon.
```

If a temporary feature access key expires, the controlled feature is disabled and a critical alarm (UAM 0368) is generated.

```
0368.0181  *C SYSTEM      Temp Key(s) have expired.
```

Any attempts to enable the controlled feature with the temporary feature access key are rejected. The controlled feature can be enabled only by entering the permanent feature access key for the controlled feature.

To clear the critical alarm (UAM 0368), the user can either enter the `chg-ctrl-feat` command with the `alarm=clear` parameter, or permanently enable the controlled feature by entering the permanent feature access key for the controlled feature.

If the critical alarm is cleared with the `chg-ctrl-feat` command, the controlled feature is disabled and cannot be enabled with the temporary feature access key. The feature can be enabled only by entering the permanent feature access key for the controlled feature.

Activating the IGTTLS feature

This procedure is used to enable and activate the Intermediate GTT Load Sharing feature.

The feature access key is based on the feature's part number and the serial number of the EAGLE 5, making the feature access key site-specific.

The `enable-ctrl-feat` command enables the Intermediate GTT Load Sharing feature by inputting the feature's access key and the feature's part number with these parameters:

`:fak` – The feature access key generated by the feature access key generator. The feature access key contains 13 alphanumeric characters and is not case sensitive.

`:partnum` – The issued part number of the Intermediate GTT Load Sharing feature, 893006901.

If the feature is being enabled with a temporary feature access key, the feature must not be in the *in-use*, *expired*, or *unavailable* state.

The `enable-ctrl-feat` command requires that the database contain a valid serial number for the EAGLE 5, and that this serial number is locked. This can be verified with the `rtrv-serial-num` command. The EAGLE 5 is shipped with a serial number in the database, but the serial number is not locked. The serial number can be changed, if necessary, and locked once the EAGLE 5 is on-site, with the `ent-serial-num` command. The `ent-serial-num` command uses these parameters.

`:serial` – The serial number assigned to the EAGLE 5. The serial number is not case sensitive.

`:lock` – Specifies whether or not the serial number is locked. This parameter has only one value, *yes*, which locks the serial number. Once the serial number is locked, it cannot be changed.

Note:

To enter and lock the EAGLE 5's serial number, the `ent-serial-num` command must be entered twice, once to add the correct serial number to the database with the `serial` parameter, then again with the `serial` and the `lock=yes` parameters to lock the serial number. You should verify that the serial number in the database is correct before locking the serial number. The serial number can be found on a label affixed to the control shelf (shelf 1100).

Once the feature has been enabled, the feature must be activated with the `chg-ctrl-feat` command. The `chg-ctrl-feat` command uses these parameters:

`:partnum` – The issued part number of the Intermediate GTT Load Sharing feature, 893006901.

`:status=on` – used to activate the features that customer has purchased and enabled.

The status of the controlled features in the EAGLE 5 is shown with the `rtrv-ctrl-feat` command.

The examples in this procedure are used to enable and activate the Intermediate GTT Load Sharing feature.

1. Display the status of the Intermediate GTT Load Sharing feature by entering the `rtrv-ctrl-feat` command.

The following is an example of the possible output.

```
rlghncxa03w 06-10-28 21:15:37 GMT EAGLE5 36.0.0
The following features have been permanently enabled:
```

Feature Name	Partnum	Status	Quantity
Command Class Management	893005801	on	----
LNP Short Message Service	893006601	on	----
Intermed GTT Load Sharing	893006901	off	----
XGTT Table Expansion	893006101	off	----
XMAP Table Expansion	893007710	on	3000
Large System # Links	893005910	on	2000
Routesets	893006401	on	6000
HC-MIM SLK Capacity	893012707	on	64

The following features have been temporarily enabled:

Feature Name	Partnum	Status	Quantity	Trial Period Left
Zero entries found.				

The following features have expired temporary keys:

Feature Name	Partnum
Zero entries found.	

If the `rtrv-ctrl-feat` output shows that the feature is permanently enabled, and its status is `on`, no further action is necessary.

If the feature is permanently enabled, and its status is `off`, skip steps 2 through 6, and go to step 7.

If the feature is temporarily enabled, and you wish to permanently enable this feature, or the temporary feature access key for that feature has expired, skip steps 2 through 5, and go to step 6.

If the feature is to remain temporarily enabled, and its status is `off`, skip steps 2 through 6, and go to step 7. If the feature's status is `on`, no further action is necessary.

If the feature is to remain temporarily enabled, and its status is `on`, no further action is necessary.

 **Note:**

If the `rtrv-ctrl-feat` output in step 1 shows any controlled features, skip steps 2 through 5, and go to step 6. If the `rtrv-ctrl-feat` output shows the HC-MIM SLK Capacity feature with a quantity of 64, steps 2 through 5 must be performed.

2. Display the serial number in the database with the `rtrv-serial-num` command. This is an example of the possible output.

```
rlghncxa03w 06-10-28 21:15:37 GMT EAGLE5 36.0.0
System serial number = nt00001231
```

System serial number is not locked.

```
rlghncxa03w 06-10-28 21:15:37 GMT EAGLE5 36.0.0
Command Completed.
```

 **Note:**

If the serial number is correct and locked, skip steps 3, 4, and 5, and go to step 6. If the serial number is correct but not locked, skip steps 3 and 4, and go to step 5. If the serial number is not correct, but is locked, this feature cannot be enabled and the remainder of this procedure cannot be performed. Contact the Customer Care Center to get an incorrect and locked serial number changed. Refer to [#unique_17](#) for the contact information. The serial number can be found on a label affixed to the control shelf (shelf 1100).

3. Enter the correct serial number into the database using the `ent-serial-num` command with the `serial` parameter.

For this example, enter this command.

```
ent-serial-num:serial=<EAGLE 5's correct serial number>
```

When this command has successfully completed, the following message should appear.

```
rlghncxa03w 06-10-28 21:15:37 GMT EAGLE5 36.0.0
ENT-SERIAL-NUM: MASP A - COMPLTD
```

4. Verify that the serial number entered into step 3 was entered correctly using the `rtrv-serial-num` command. This is an example of the possible output.

```
rlghncxa03w 06-10-28 21:15:37 GMT EAGLE5 36.0.0
System serial number = nt00001231
```

System serial number is not locked.

```
rlghncxa03w 06-10-28 21:15:37 GMT EAGLE5 36.0.0  
Command Completed.
```

If the serial number was not entered correctly, repeat steps 3 and 4 and re-enter the correct serial number.

5. Lock the serial number in the database by entering the `ent-serial-num` command with the serial number shown in step 2, if the serial number shown in step 2 is correct, or with the serial number shown in step 4, if the serial number was changed in step 3, and with the `lock=yes` parameter.

For this example, enter this command.

```
ent-serial-num:serial=<EAGLE 5's serial number>:lock=yes
```

When this command has successfully completed, the following message should appear.

```
rlghncxa03w 06-10-28 21:15:37 GMT EAGLE5 36.0.0  
ENT-SERIAL-NUM: MASP A - COMPLTD
```

6. Enable the Intermediate GTT Load Sharing feature with either a permanent key or temporary key by entering the `enable-ctrl-feat` command. For this example, enter this command.

```
enable-ctrl-feat:partnum=893006901:fak=<IGTTLS feature access  
key>
```

 **Note:**

The values for the feature access key (the `fak` parameter) are provided. If you do not have the feature access key for the Intermediate GTT Load Sharing feature, contact your Sales Representative or Account Representative.

When the `enable-ctrl-feat` command has successfully completed, this message should appear.

```
rlghncxa03w 06-10-28 21:15:37 GMT EAGLE5 36.0.0  
ENABLE-CTRL-FEAT: MASP B - COMPLTD
```

 **Note:**

If a temporarily enabled feature was permanently enabled in step 6, and the status of the temporarily enabled feature was on, skip step 7 and go to step 8.

7. Display the cards in the EAGLE 5 using the `rtrv-card` command. The IGTTLS features requires that service modules are in the database. This is an example of the possible output.

```
rlghncxa03w 13-05-25 09:58:31 GMT EAGLE5 45.0.0
CARD   TYPE      APPL      LSET NAME    PORT SLC LSET NAME
PORT SLC
1102   TSM          GLS
1113   E5MCAP      OAMHC
1114   E5TDM-A
1115   E5MCAP      OAMHC
1116   E5TDM-B
1117   E5MDAL
1201   LIMDS0      SS7ANSI    sp2          A    0    sp1
B      0
1203   LIMDS0      SS7ANSI    sp3          A    0
1204   LIMDS0      SS7ANSI    sp3          A    1
1206   LIMDS0      SS7ANSI    nsp3        A    1    nsp4
B      1
1308   LIMDS0      SS7ANSI    sp6          A    1    sp7
B      0
1314   LIMDS0      SS7ANSI    sp7          A    1    sp5
B      1
```

Service modules are shown by the entries `SCCP` or `VSCCP` in `APPL` column. If the `rtrv-card` output shows no service modules, or that the type of service modules required to support the IGTTLS feature is not in the database, perform [Adding a Service Module](#) to make sure that the proper hardware is in place to support the IGTTLS feature.

8. The Intermediate GTT Load Sharing feature enabled in step 6 must be turned on using the `chg-ctrl-feat` command, specifying the Intermediate GTT Load Sharing feature part number used in step 6 and the `status=on` parameter. For this example, enter this command.

```
chg-ctrl-feat:partnum=893006901:status=on
```

When this command has successfully completed, the following message should appear.

```
rlghncxa03w 06-10-28 21:15:37 GMT EAGLE5 36.0.0
CHG-CTRL-FEAT: MASP B - COMPLTD
```

9. Verify the changes by entering the `rtrv-ctrl-feat` command. The following is an example of the possible output.

```
rlghncxa03w 06-10-28 21:15:37 GMT EAGLE5 36.0.0
The following features have been permanently enabled:
```

Feature Name	Partnum	Status	Quantity
Command Class Management	893005801	on	----
LNP Short Message Service	893006601	on	----
Intermed GTT Load Sharing	893006901	on	----
XGTT Table Expansion	893006101	off	----
XMAP Table Expansion	893007710	on	3000

```
Large System # Links      893005910  on    2000
Routesets                 893006401  on    6000
HC-MIM SLK Capacity      893012707  on     64
```

The following features have been temporarily enabled:

```
Feature Name              Partnum   Status  Quantity  Trial
Period Left
Zero entries found.
```

The following features have expired temporary keys:

```
Feature Name              Partnum
Zero entries found.
```

10. Backup the new changes using the `chg-db:action=backup:dest=fixed` command.

These messages should appear, the active Maintenance and Administration Subsystem Processor (MASP) appears first.

```
BACKUP (FIXED) : MASP A - Backup starts on active MASP.
BACKUP (FIXED) : MASP A - Backup on active MASP to fixed disk
complete.
BACKUP (FIXED) : MASP A - Backup starts on standby MASP.
BACKUP (FIXED) : MASP A - Backup on standby MASP to fixed disk
complete.
```

Figure 5-1 Activate the IGTTLS Feature - Sheet 1 of 4

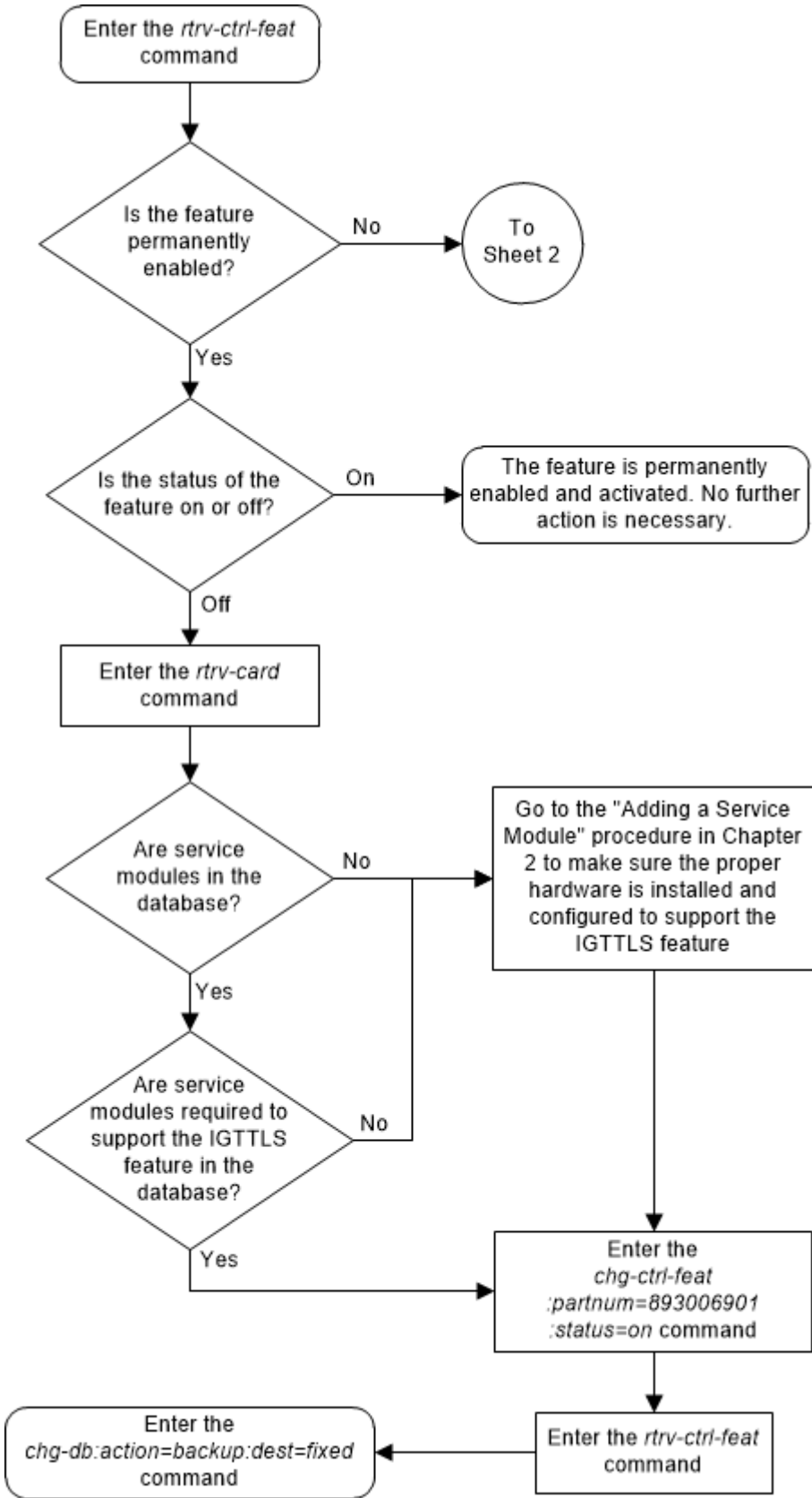

Figure 5-2 Activate the IGTTLS Feature - Sheet 2 of 4

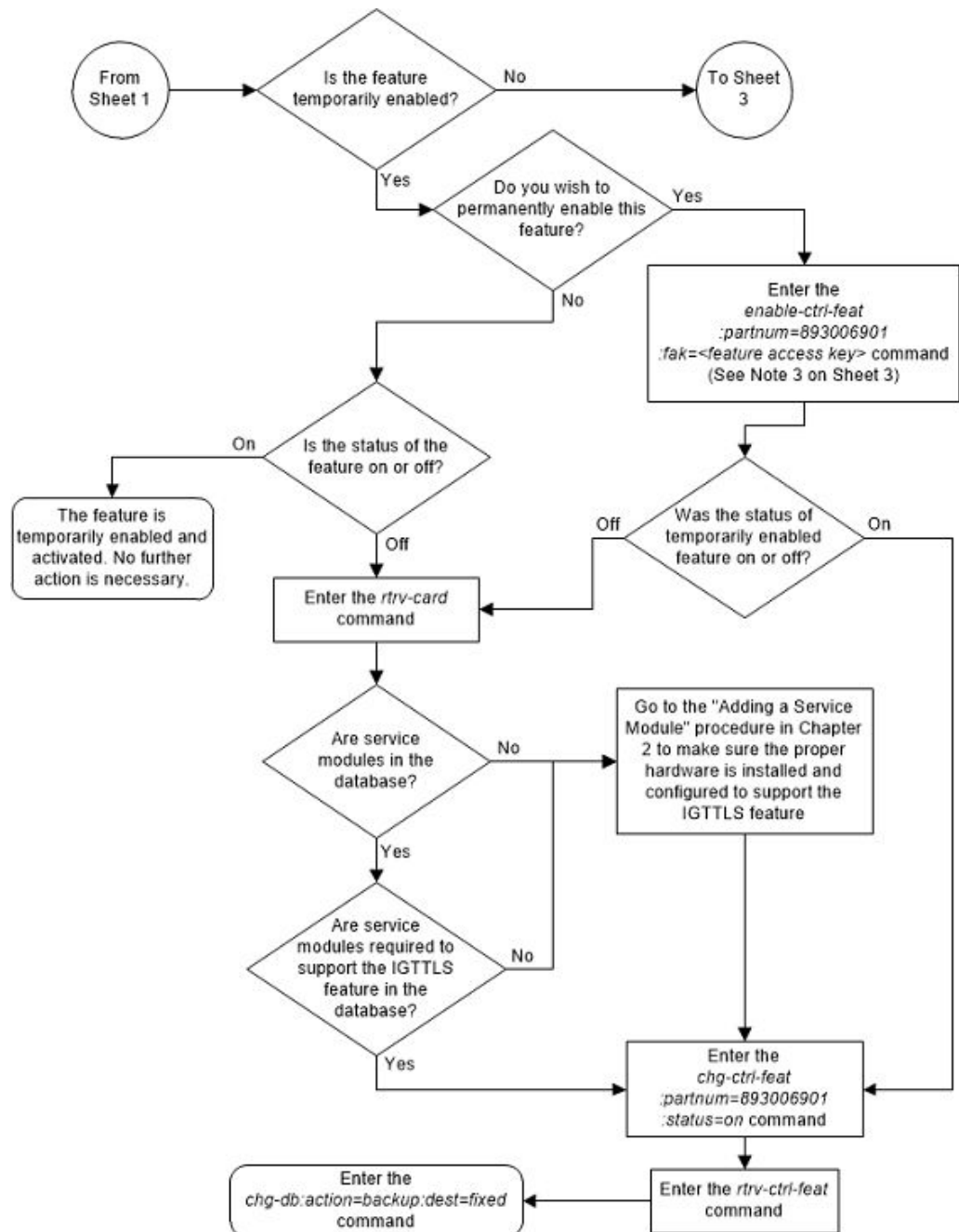

Figure 5-3 Activate the IGTTLS Feature - Sheet 3 of 4

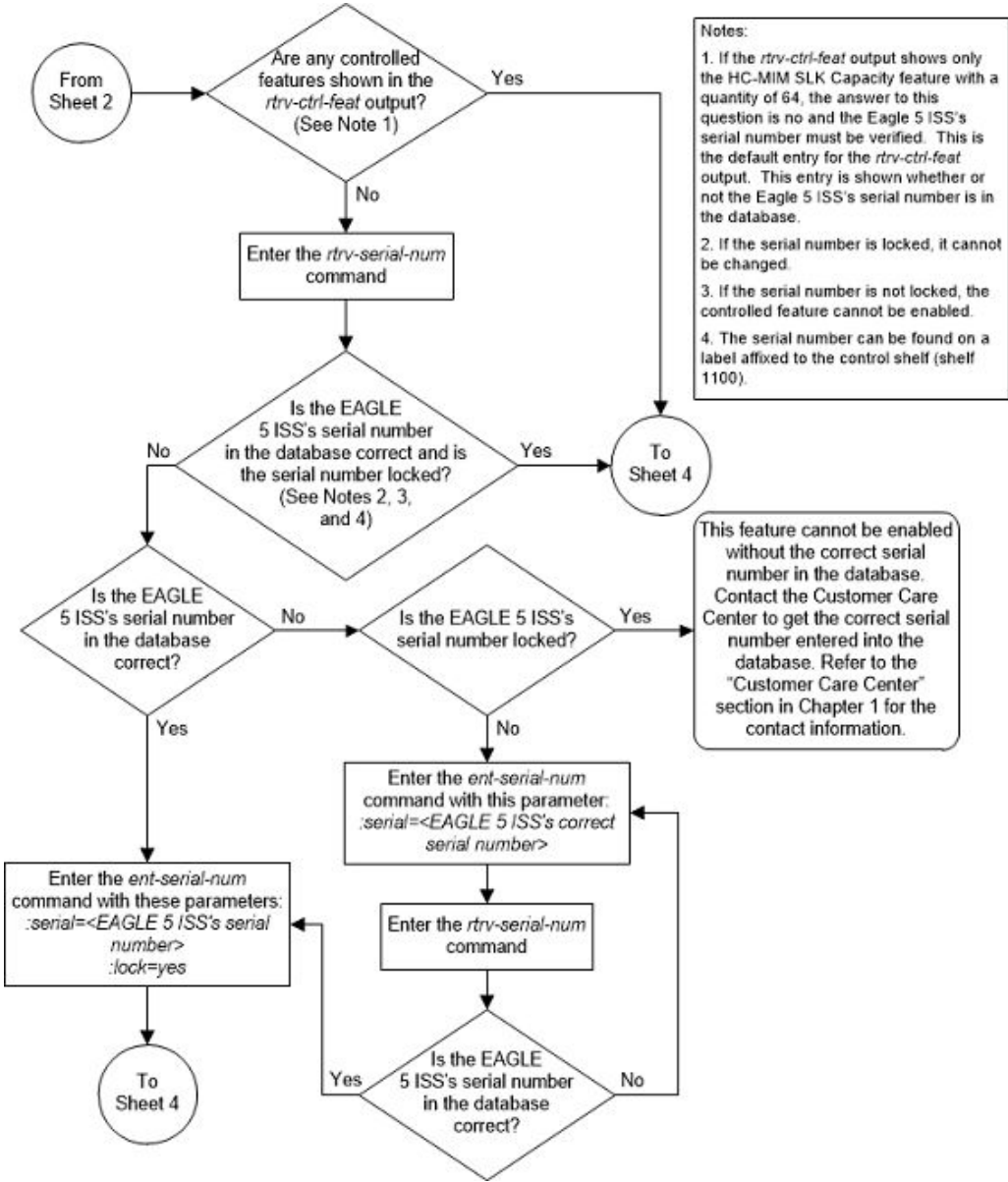
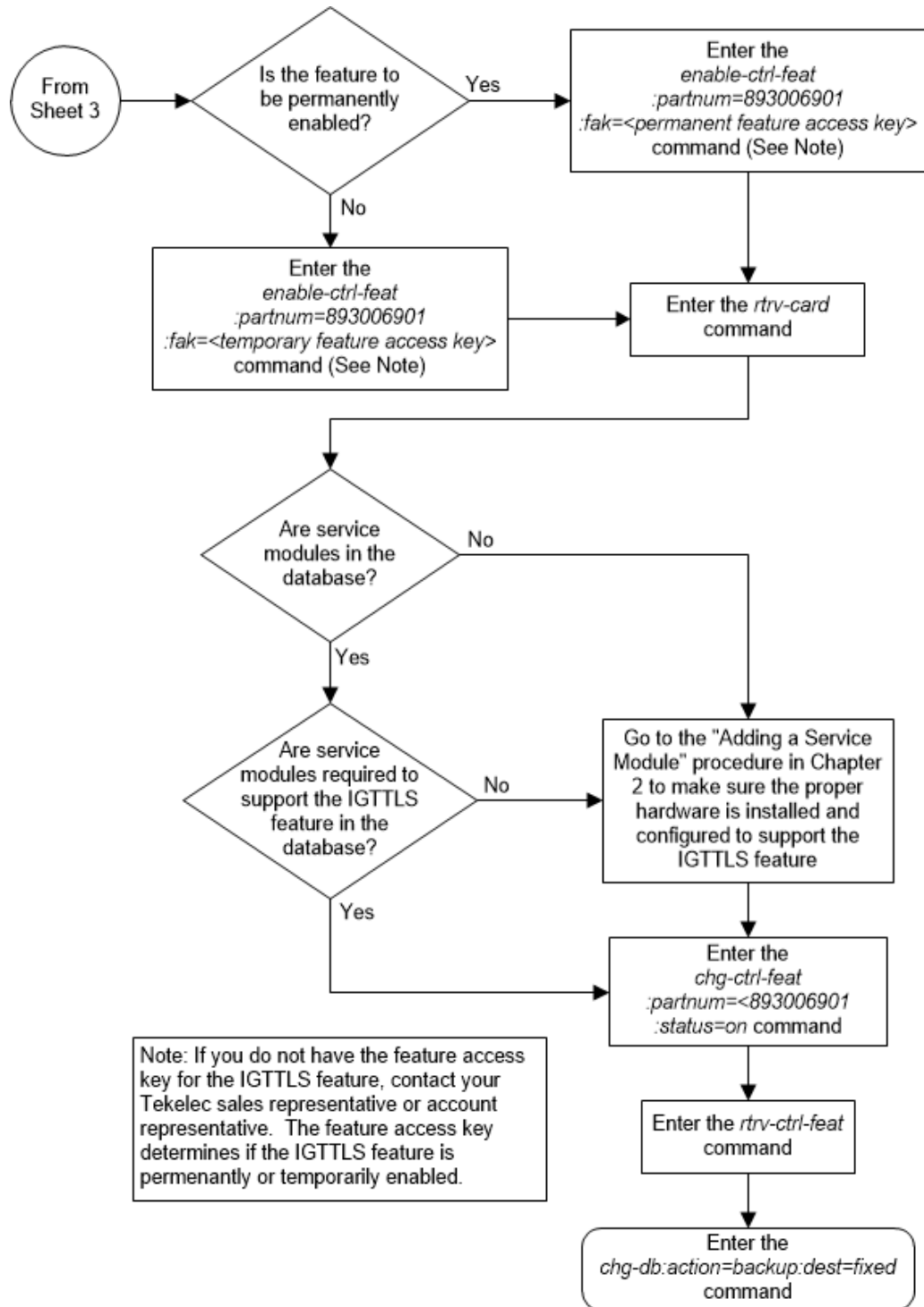

Figure 5-4 Activate the IGTTLS Feature - Sheet 4 of 4



Clearing a Temporary FAK Alarm

This procedure is used to clear the critical alarm, UAM 0368, generated when a temporary feature access key has expired, using the `chg-ctrl-feat` command.

The `chg-ctrl-feat` command uses the following parameters:

`:partnum` - The part number of the controlled feature that was temporarily enabled and is causing the alarm.

`:alarm=clear` - Clears UAM 0368, Temp Key(s) have expired.

The controlled feature must have been temporarily enabled and is now in danger of expiration or in an *expired* state.

1. Display the controlled feature that has the expired feature access key by entering the `rtrv-ctrl-feat:expired=yes` command.

The following is an example of the possible output.

```
rlghncxa03w 06-10-28 21:17:37 GMT EAGLE5 36.0.0
The following features have expired temporary keys:
Feature Name          Part Num
Intermed GTT Load Sharing 893006901
```

2. Clear the EAGLE alarm in the database by entering the `chg-ctrl-feat` command.

For example, enter this command.

```
chg-ctrl-feat:partnum=893006901:alarm=clear
```

When this command has successfully completed, the following message should appear.

```
rlghncxa03w 06-10-28 21:16:37 GMT EAGLE5 36.0.0
CHG-CTRL-FEAT: MASP A - COMPLTD
```

3. Verify that the alarm has cleared in the database by using the `rtrv-ctrl-feat:expired=yes` command.

The following is an example of the possible output.

```
rlghncxa03w 06-10-28 21:16:37 GMT EAGLE5 36.0.0
0367.0181 * SYSTEM      Temp Key(s) expiration alarm cleared.
```

4. Backup the new changes using the `chg-db:action=backup:dest=fixed` command.

These messages should appear, the active Maintenance and Administration Subsystem Processor (MASP) appears first.

```
BACKUP (FIXED) : MASP A - Backup starts on active MASP.
BACKUP (FIXED) : MASP A - Backup on active MASP to fixed disk
complete.
BACKUP (FIXED) : MASP A - Backup starts on standby MASP.
BACKUP (FIXED) : MASP A - Backup on standby MASP to fixed disk
complete.
```

Figure 5-5 Clear a Temporary FAK Alarm

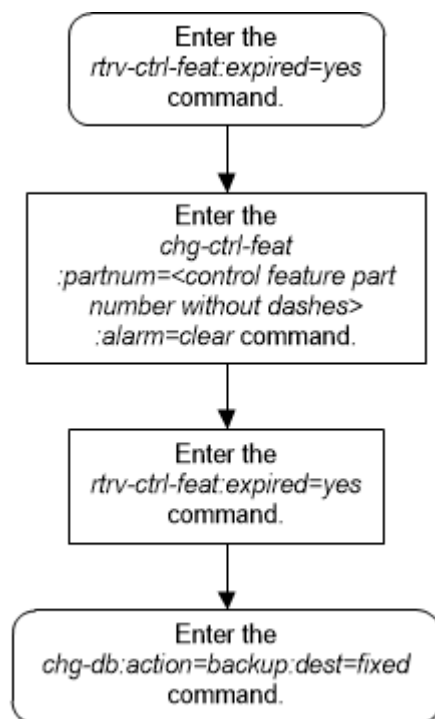

Turning Off the IGTTLS Feature

This procedure is used to turn off the IGTTLS feature, using the `chg-ctrl-feat` command.

The `chg-ctrl-feat` command uses the following parameters:

`:partnum` - The part number of the IGTTLS feature, 893006901.

`:status=off` – used to deactivate the IGTTLS feature.

The status of the IGTTLS controlled feature must be `on` and is shown with the `rtrv-ctrl-feat` command.

The GTT Load Sharing with Alternate Routing Indicator feature must be turned off before the IGTTLS feature can be turned off.

▲ Caution:

If the IGTTLS feature is deactivated, the `ent-mrn` and `chg-mrn` commands cannot be executed, and mated relay node groups and point codes cannot be configured in the database. The mated relay node groups and point codes can be displayed with the `rtrv-mrn` command and removed from the database with the `dlt-mrn` command if the IGTTLS feature is deactivated.

1. Display the status of the IGTTLS feature by entering the `rtrv-ctrl-feat:partnum=893006901` command.

The following is an example of the possible output.

```
rlghncxa03w 06-10-28 21:15:37 GMT EAGLE5 36.0.0
```

The following features have been permanently enabled:

Feature Name	Partnum	Status	Quantity
Intermed Gtt Load Sharing	893006901	on	----

The following features have been temporarily enabled:

Feature Name	Partnum	Status	Quantity	Trial
Period Left				
Zero entries found.				

The following features have expired temporary keys:

Feature Name	Partnum
Zero entries found.	

If the status of the IGTTLS feature is off, or if the IGTTLS feature is not enabled, this procedure cannot be performed.

2. Before the IGTTLS feature can be turned off, the GTT Load Sharing with Alternate Routing Indicator feature must be turned off.

Verify the status of the GTT Load Sharing with Alternate Routing Indicator feature by entering the `rtrv-ctrl-feat:partnum=893027401` command.

The following is an example of the possible output.

```
rlghncxa03w 09-02-28 21:15:37 GMT EAGLE5 40.1.0
```

The following features have been permanently enabled:

Feature Name	Partnum	Status	Quantity
GTT LS ARI	893027401	on	----

The following features have been temporarily enabled:

Feature Name	Partnum	Status	Quantity	Trial
Period Left				
Zero entries found.				

The following features have expired temporary keys:

Feature Name	Partnum
Zero entries found.	

If the GTT Load Sharing with Alternate Routing Indicator feature is not enabled and turned on, continue the procedure with 3.

If the GTT Load Sharing with Alternate Routing Indicator feature is enabled and turned on, perform [Turning Off the GTT Load Sharing with Alternate Routing Indicator Feature](#) to turn the GTT Load Sharing with Alternate Routing Indicator

feature off. After the GTT Load Sharing with Alternate Routing Indicator feature has been turned off, continue the procedure with 3.

3. Turn off the IGTTLs feature by entering the `chg-ctrl-feat` command with the `status=off` parameter.

For example, enter this command.

```
chg-ctrl-feat:partnum=893006901:status=off
```

When this command has successfully completed, the following message should appear.

```
rlghncxa03w 06-10-28 21:16:37 GMT EAGLE5 36.0.0  
CHG-CTRL-FEAT: MASP A - COMPLTD
```

4. Verify that the IGTTLs feature has been turned off by using the `rtrv-ctrl-feat:partnum=893006901` command. The following is an example of the possible output.

```
rlghncxa03w 06-10-28 21:15:37 GMT EAGLE5 36.0.0  
The following features have been permanently enabled:
```

Feature Name	Partnum	Status	Quantity
Intermed Gtt Load Sharing	893006901	off	----

The following features have been temporarily enabled:

Feature Name	Partnum	Status	Quantity	Trial
Period Left				

Zero entries found.

The following features have expired temporary keys:

Feature Name	Partnum
Zero entries found.	

5. Backup the new changes using the `chg-db:action=backup:dest=fixed` command.

These messages should appear, the active Maintenance and Administration Subsystem Processor (MASP) appears first.

```
BACKUP (FIXED) : MASP A - Backup starts on active MASP.  
BACKUP (FIXED) : MASP A - Backup on active MASP to fixed disk  
complete.  
BACKUP (FIXED) : MASP A - Backup starts on standby MASP.  
BACKUP (FIXED) : MASP A - Backup on standby MASP to fixed disk  
complete.
```

Figure 5-6 Turn Off the IGTTLS Feature

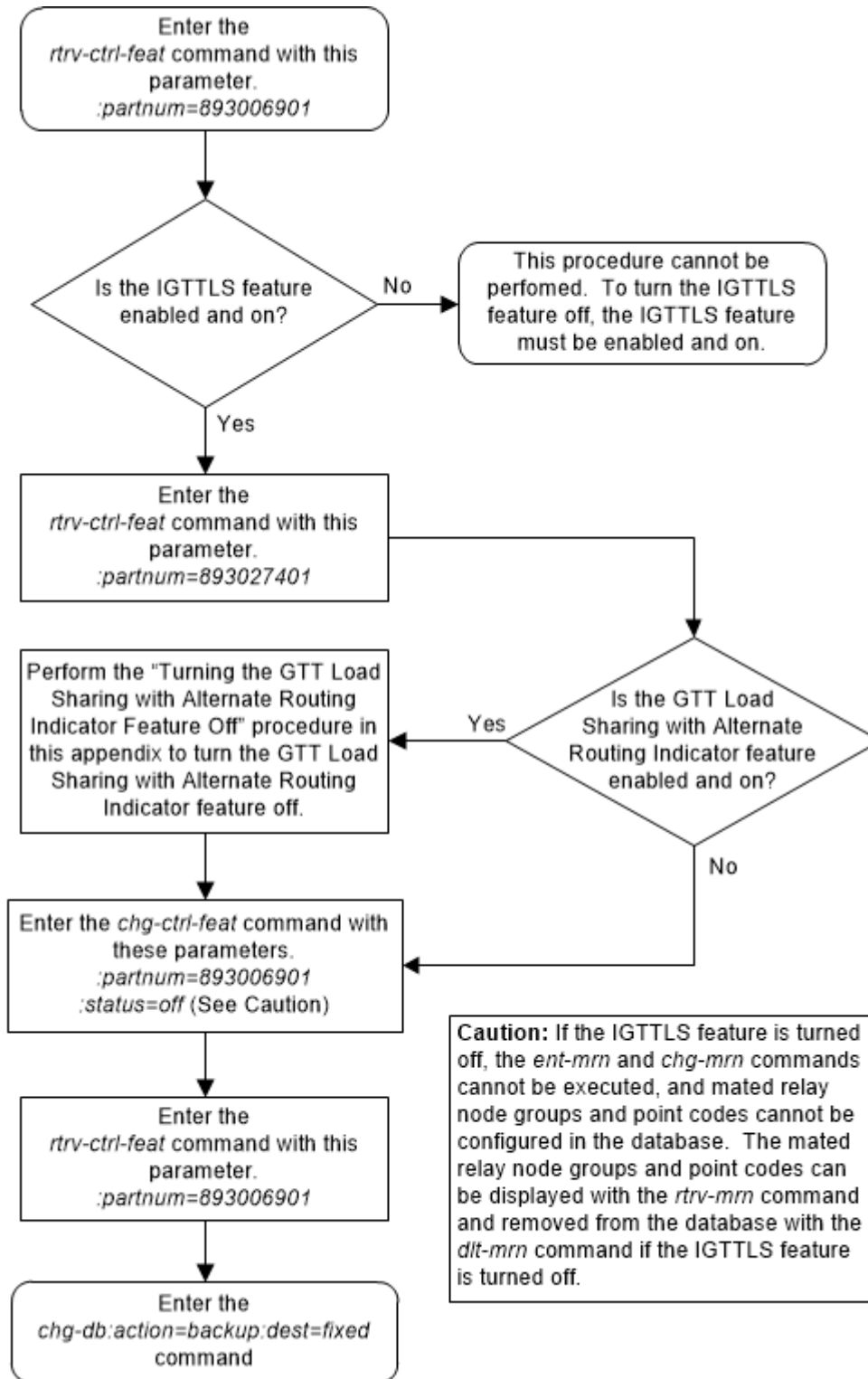

Enabling the XGTT Table Expansion Feature

This procedure is used to enable the XGTT Table Expansion feature using the feature's part number and a feature access key.

The feature access key for the XGTT Table Expansion feature is based on the feature's part number and the serial number of the EAGLE, making the feature access key site-specific.

This feature allows the user to increase the maximum number of entries in the global title translation table from 269,999 entries to either 400,000 or 1,000,000 entries. Each level of increase has its own part number.

- Increase to 400,000 entries – part number 893006101
- Increase to 1,000,000 entries – part number 893006110

This feature requires that the following hardware is installed:

- E5-MCAP cards are installed in card locations 1113 and 1115.
- For a maximum of 400,000 entries, all service modules in the EAGLE can be E5-SM4G cards.
- For a maximum of 1,000,000 entries, all service modules in the EAGLE must be E5-SM8G-B or SLIC cards.

The service module requirements are dependent on any other GTT-related features that are enabled. Perform [Adding a Service Module](#) to make sure that the proper hardware is in place to support the XGTT Table Expansion feature.

The XGTT Table Expansion feature requires that the Global Title Translation (GTT) feature is enabled with the `chg-feat` command using the `gtt=on` parameters.

Note:

Once the Global Title Translation feature is turned on with the `chg-feat` command, it cannot be turned off.

The Global Title Translation feature must be purchased before it can be turned on. If you are not sure whether you have purchased the Global Title Translation feature, contact your Sales Representative or Account Representative.

The `enable-ctrl-feat` command enables the XGTT Table Expansion feature by inputting the feature's access key and the feature's part number with these parameters:

`:fak` – The feature access key provided. The feature access key contains 13 alphanumeric characters and is not case sensitive. The feature access key is optional.

`:partnum` – The issued part number of the XGTT Table Expansion feature, for 400,000 entries – 893006101, for 1,000,000 entries – 893006110

The `enable-ctrl-feat` command requires that the database contain a valid serial number for the EAGLE, and that this serial number is locked. This can be verified with the `rtrv-serial-num` command. The EAGLE is shipped with a serial number in the

database, but the serial number is not locked. The serial number can be changed, if necessary, and locked once the EAGLE 5 is on-site, with the `ent-serial-num` command. The `ent-serial-num` command uses these parameters.

`:serial` – The serial number assigned to the EAGLE. The serial number is not case sensitive.

`:lock` – Specifies whether or not the serial number is locked. This parameter has only one value, `yes`, which locks the serial number. Once the serial number is locked, it cannot be changed.

 **Note:**

To enter and lock the EAGLE's serial number, the `ent-serial-num` command must be entered twice, once to add the correct serial number to the database with the `serial` parameter, then again with the `serial` and the `lock=yes` parameters to lock the serial number. You should verify that the serial number in the database is correct before locking the serial number. The serial number can be found on a label affixed to the control shelf (shelf 1100).

This feature cannot be temporarily enabled.

Once this feature is enabled with the `enable-ctrl-feat` command (for either 400,000 or 1,000,000 entries), the feature is also activated. This feature cannot be disabled with the `chg-ctrl-feat` command. The `chg-ctrl-feat` command cannot be used with this procedure.

1. Display the status of the XGTT Table Expansion feature by entering the `rtrv-ctrl-feat` command.

The following is an example of the possible output.

```
rlghncxa03w 06-10-28 21:15:37 GMT EAGLE5 36.0.0
The following features have been permanently enabled:
```

Feature Name	Partnum	Status	Quantity
Command Class Management	893005801	on	----
LNP Short Message Service	893006601	on	----
Intermed GTT Load Sharing	893006901	on	----
XGTT Table Expansion	893006101	off	----
XMAP Table Expansion	893007710	on	3000
Large System # Links	893005910	on	2000
Routesets	893006401	on	6000
HC-MIM SLK Capacity	893012707	on	64

```
The following features have been temporarily enabled:
```

Feature Name	Partnum	Status	Quantity	Trial
Period Left				
Zero entries found.				

```
The following features have expired temporary keys:
```

```
Feature Name          Partnum
Zero entries found.
```

If the `rtrv-ctrl-feat` output shows that the feature is permanently enabled for the desired quantity or for a quantity that is greater than the desired quantity, no further action is necessary. This procedure does not need to be performed.

If the quantity shown for the XGTT Table Expansion feature is less than the desired quantity, skip steps 2 through 5, and go to step 6.

2. Display the cards in the EAGLE using the `rtrv-card` command.

The XGTT Table Expansion feature requires that service modules are in the database. This is an example of the possible output.

```
rlghncxa03w 09-05-25 09:58:31 GMT EAGLE5 41.0.0
CARD  TYPE      APPL      LSET NAME      PORT SLC LSET NAME
PORT SLC
1102  TSM          GLS
1113  E5MCAP       OAMHC
1114  E5TDM-A
1115  E5MCAP       OAMHC
1116  E5TDM-B
1117  E5MDAL
1201  LIMDS0       SS7ANSI  sp2            A    0    sp1
B    0
1203  LIMDS0       SS7ANSI  sp3            A    0
1204  LIMDS0       SS7ANSI  sp3            A    1
1206  LIMDS0       SS7ANSI  nsp3           A    1    nsp4
B    1
1308  LIMDS0       SS7ANSI  sp6            A    1    sp7
B    0
1314  LIMDS0       SS7ANSI  sp7            A    1    sp5
B    1
Service modules
```

are shown by the entries `SCCP` or `VSCCP` in `APPL` column. If the `rtrv-card` output shows no service modules, Perform [Adding a Service Module](#) to add the necessary service modules.

If the `rtrv-card` output shows that the type of service module required to support the XGTT Table Expansion feature is not in the database, perform [Adding a Service Module](#) to make sure that the proper service modules are in place to support the XGTT Table Expansion feature.

3. Display the serial number in the database with the `rtrv-serial-num` command.

 **Note:**

If the `rtrv-ctrl-feat` output in step 1 shows any controlled features, or if the XGTT Table Expansion feature is enabled for a quantity that is less than the desired quantity, skip steps 3 through 6, and go to step 7. If the `rtrv-ctrl-feat` output shows only the HC-MIM SLK Capacity feature with a quantity of 64, steps 3 through 6 must be performed.

This is an example of the possible output.

```
rlghncxa03w 06-10-28 21:15:37 GMT EAGLE5 36.0.0  
System serial number = nt00001231
```

System serial number is not locked.

```
rlghncxa03w 06-10-28 21:15:37 GMT EAGLE5 36.0.0  
Command Completed.
```

4. Enter the correct serial number into the database using the `ent-serial-num` command with the `serial` parameter.

 **Note:**

If the serial number is correct and locked, skip steps 4, 5, and 6, and go to step 7. If the serial number is correct but not locked, skip steps 4 and 5, and go to step 6. If the serial number is not correct, but is locked, this feature cannot be enabled and the remainder of this procedure cannot be performed. Contact [#unique_17](#) to get an incorrect and locked serial number changed. Refer to [#unique_17](#) for the contact information. The serial number can be found on a label affixed to the control shelf (shelf 1100).

For this example, enter this command.

```
ent-serial-num:serial=<EAGLE's correct serial number>
```

When this command has successfully completed, the following message should appear.

```
rlghncxa03w 06-10-28 21:15:37 GMT EAGLE5 36.0.0  
ENT-SERIAL-NUM: MASP A - COMPLTD
```

5. Verify that the serial number entered into step 4 was entered correctly using the `rtrv-serial-num` command.

This is an example of the possible output.

```
rlghncxa03w 06-10-28 21:15:37 GMT EAGLE5 36.0.0  
System serial number = nt00001231
```

System serial number is not locked.

```
rlghncxa03w 06-10-28 21:15:37 GMT EAGLE5 36.0.0  
Command Completed.
```

If the serial number was not entered correctly, repeat steps 4 and 5 and re-enter the correct serial number.

6. Lock the serial number in the database by entering the `ent-serial-num` command with the serial number shown in step 3, if the serial number shown in step 3 is correct, or with the serial number shown in step 5, if the serial number was changed in step 4, and with the `lock=yes` parameter.

For this example, enter this command.

```
ent-serial-num:serial=<EAGLE's serial number>:lock=yes
```

When this command has successfully completed, the following message should appear.

```
rlghncxa03w 06-10-28 21:15:37 GMT EAGLE5 36.0.0  
ENT-SERIAL-NUM: MASP A - COMPLTD
```

7. Enable the XGTT Table Expansion feature for the desired quantity with the `enable-ctrl-feat` command specifying the part number corresponding to the new quantity of entries for the GTT table.

For this example, enter one of these commands.

To increase the number of entries in the GTT table to 400,000, enter this command.

```
enable-ctrl-feat:partnum=893006101
```

To increase the number of entries in the GTT table to 1,000,000, enter this command.

```
enable-ctrl-feat:partnum=893006110
```

When the `enable-ctrl-feat` command has successfully completed, this message should appear.

```
rlghncxa03w 06-10-28 21:15:37 GMT EAGLE5 36.0.0  
ENABLE-CTRL-FEAT: MASP B - COMPLTD
```

8. Verify the changes by entering the `rtrv-ctrl-feat` command with the part number specified in step 7.

Enter one of these commands.

```
rtrv-ctrl-feat:partnum=893006101
```

The following is an example of the possible output.

```
rlghncxa03w 06-10-28 21:15:37 GMT EAGLE5 36.0.0  
The following features have been permanently enabled:
```

Feature Name	Partnum	Status	Quantity
XGTT Table Expansion	893006101	on	400000

The following features have been temporarily enabled:

Feature Name	Partnum	Status	Quantity	Trial Period Left
Zero entries found.				

The following features have expired temporary keys:

Feature Name	Partnum
Zero entries found.	

```
rtrv-ctrl-feat:partnum=893006110
```

The following is an example of the possible output.

```
rlghncxa03w 06-10-28 21:15:37 GMT EAGLE5 36.0.0
```

The following features have been permanently enabled:

Feature Name	Partnum	Status	Quantity
XGTT Table Expansion	893006110	on	1000000

The following features have been temporarily enabled:

Feature Name	Partnum	Status	Quantity	Trial Period Left
Zero entries found.				

The following features have expired temporary keys:

Feature Name	Partnum
Zero entries found.	

9. Backup the new changes using the `chg-db:action=backup:dest=fixed` command.

These messages should appear, the active Maintenance and Administration Subsystem Processor (MASP) appears first.

```
BACKUP (FIXED) : MASP A - Backup starts on active MASP.  
BACKUP (FIXED) : MASP A - Backup on active MASP to fixed disk  
complete.  
BACKUP (FIXED) : MASP A - Backup starts on standby MASP.  
BACKUP (FIXED) : MASP A - Backup on standby MASP to fixed disk  
complete.
```

Figure 5-7 Enable the XGTT Table Expansion Feature - Sheet 1 of 4

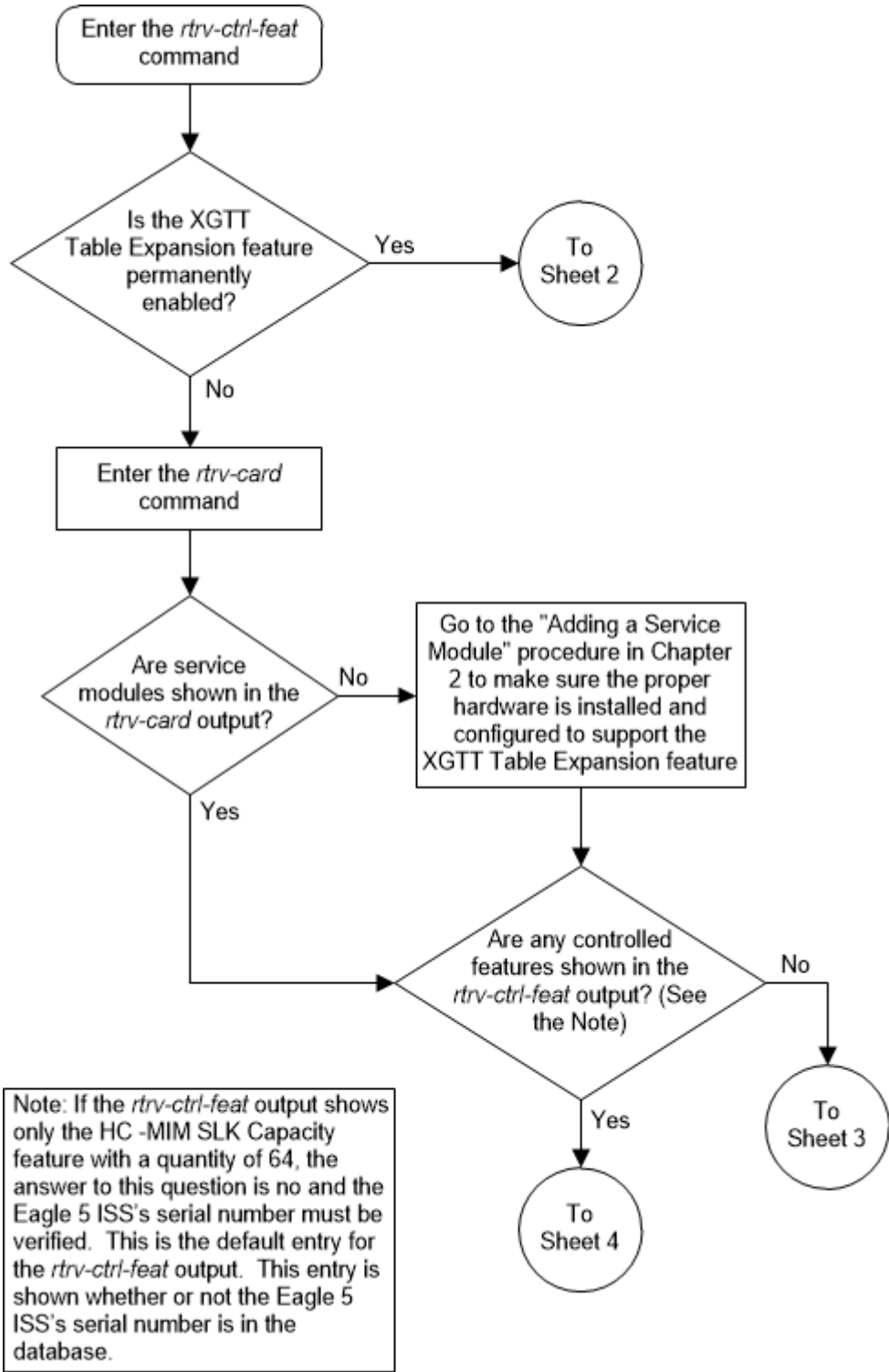

Figure 5-8 Enable the XGTT Table Expansion Feature - Sheet 2 of 4

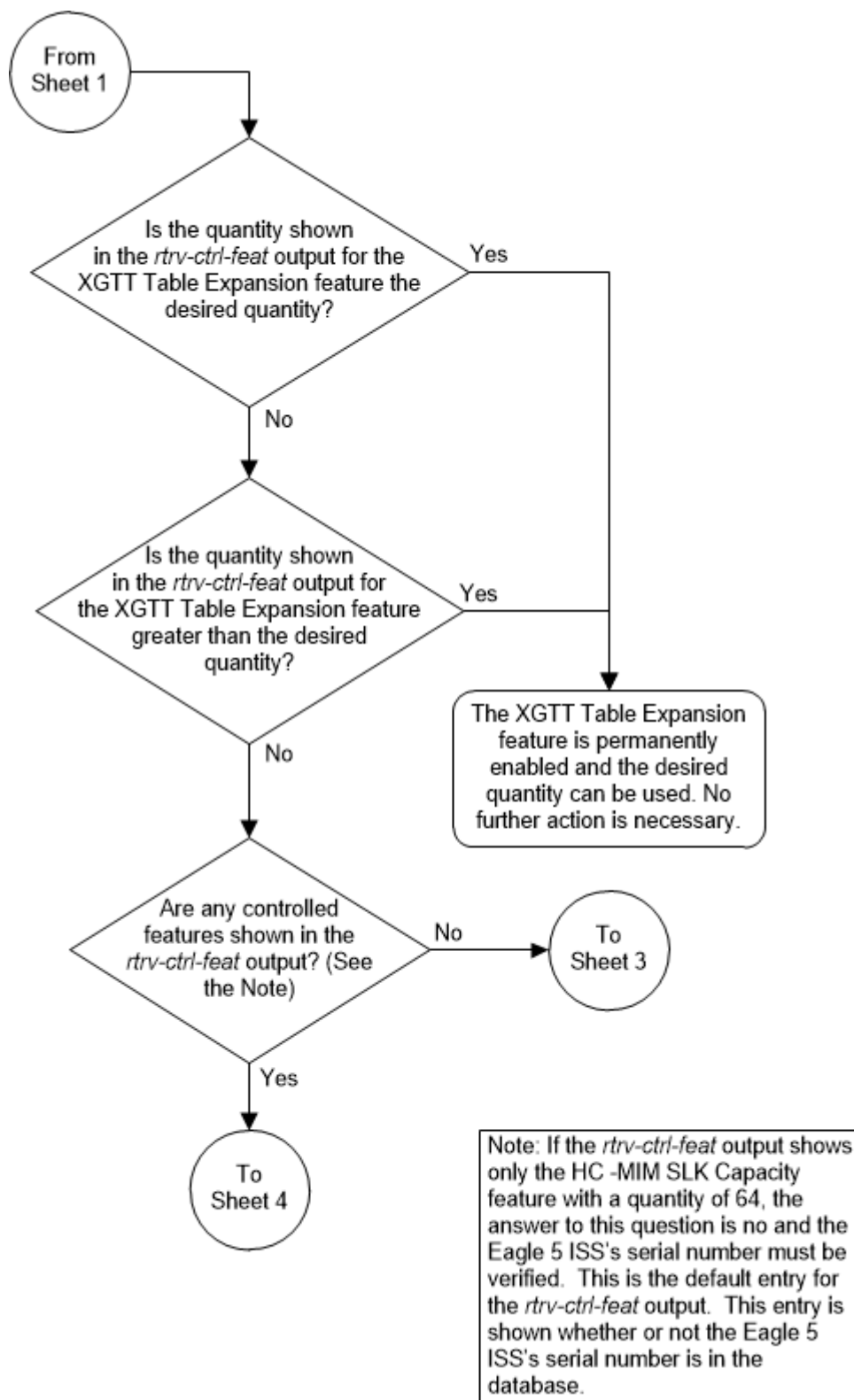

Figure 5-9 Enable the XGTT Table Expansion Feature - Sheet 3 of 4

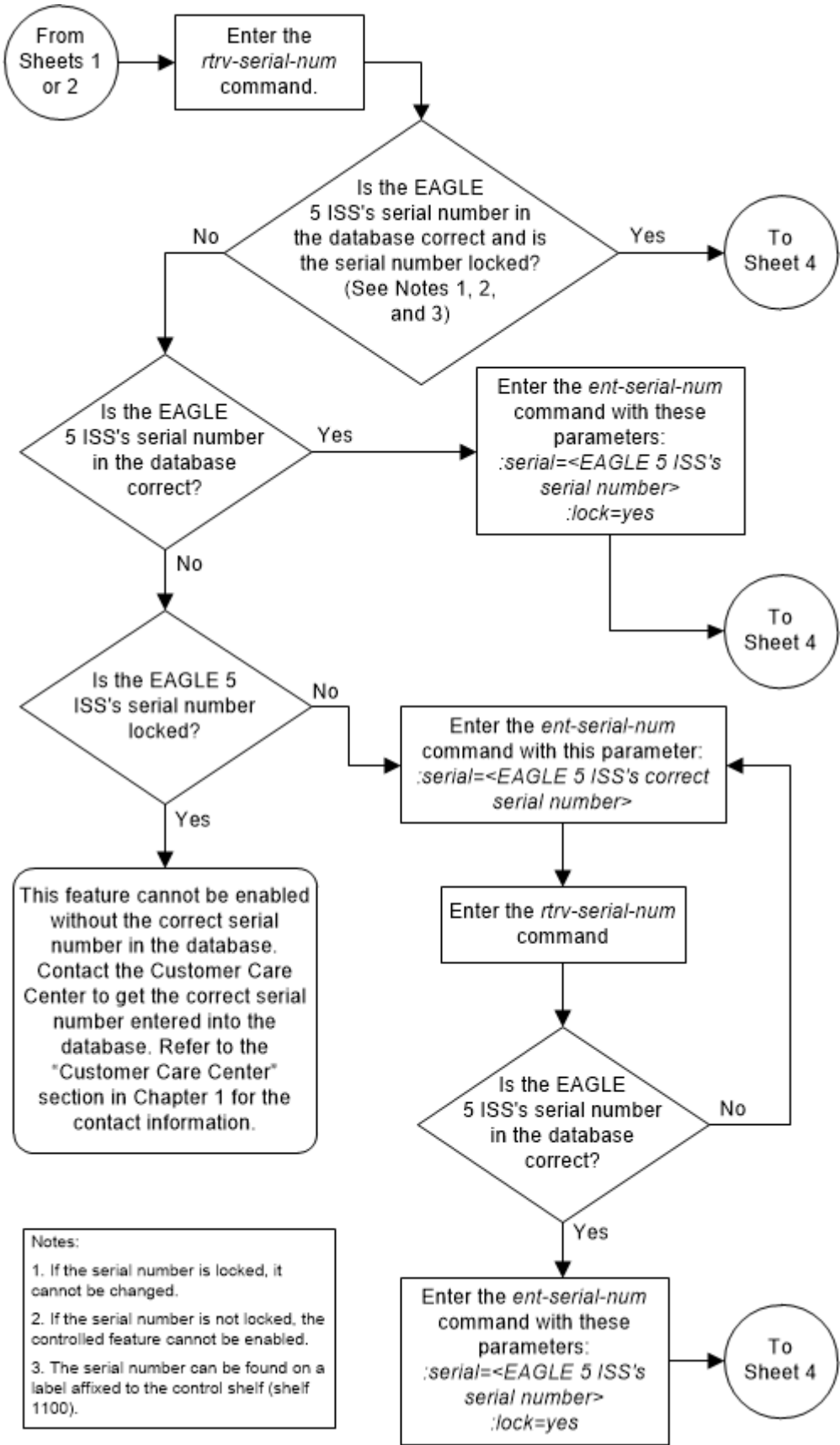
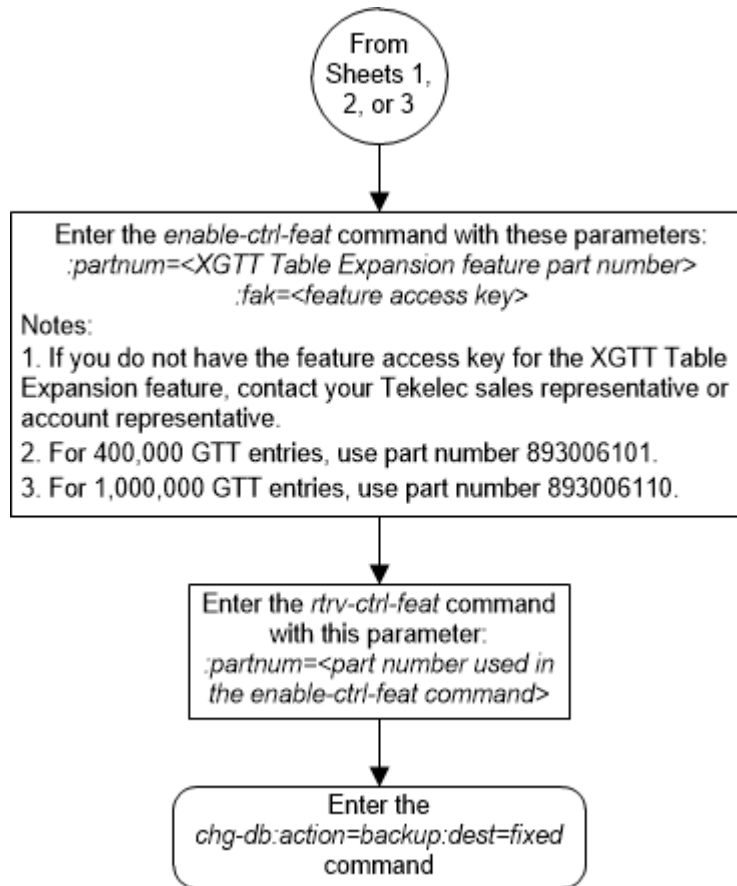

Figure 5-10 Enable the XGTT Table Expansion Feature - Sheet 4 of 4



Enabling the XMAP Table Expansion Feature

This procedure is used to enable the XMAP Table Expansion feature using the feature's part number and a feature access key.

The feature access key for the XMAP Table Expansion feature is based on the feature's part number and the serial number of the EAGLE, making the feature access key site-specific.

This feature allows the user to increase the maximum number of entries in the mated application table from 1024 entries to either 2000 or 3000 entries. Each level of increase has its own part number.

- Increase to 2000 entries – part number 893007701
- Increase to 3000 entries – part number 893007710

This feature requires that the following hardware is installed:

- E5-MCAP cards are installed in card locations 1113 and 1115.
- For a maximum of 2000 or 3000 entries, all service modules in the EAGLE can be either SMs or E5-SM4G cards.

The service module requirements are dependent on any other GTT-related features that are enabled. Perform [Adding a Service Module](#) to make sure that the proper hardware is in place to support the XMAP Table Expansion feature.

The XMAP Table Expansion feature requires that the Global Title Translation (GTT) feature is enabled with the `chg-feat` command using the `gtt=on` parameters.

 **Note:**

Once the Global Title Translation feature is turned on with the `chg-feat` command, it cannot be turned off.

The Global Title Translation feature must be purchased before it can be turned on. If you are not sure whether you have purchased the Global Title Translation feature, contact your Sales Representative or Account Representative.

The `enable-ctrl-feat` command enables the controlled feature by inputting the feature's access key and the feature's part number with these parameters:

`:fak` – The feature access key generated by the feature access key generator. The feature access key contains 13 alphanumeric characters and is not case sensitive.

`:partnum` – The issued part number of the XMAP Table Expansion feature, for 2,000 entries – 893007701, for 3,000 entries – 893007710

The `enable-ctrl-feat` command requires that the database contain a valid serial number for the EAGLE, and that this serial number is locked. This can be verified with the `rtrv-serial-num` command. The EAGLE is shipped with a serial number in the database, but the serial number is not locked. The serial number can be changed, if necessary, and locked once the EAGLE is on-site, with the `ent-serial-num` command. The `ent-serial-num` command uses these parameters.

`:serial` – The serial number assigned to the EAGLE. The serial number is not case sensitive.

`:lock` – Specifies whether or not the serial number is locked. This parameter has only one value, `yes`, which locks the serial number. Once the serial number is locked, it cannot be changed.

 **Note:**

To enter and lock the EAGLE's serial number, the `ent-serial-num` command must be entered twice, once to add the correct serial number to the database with the `serial` parameter, then again with the `serial` and the `lock=yes` parameters to lock the serial number. You should verify that the serial number in the database is correct before locking the serial number. The serial number can be found on a label affixed to the control shelf (shelf 1100).

This feature cannot be temporarily enabled (with the temporary feature access key).

Once this feature is enabled with the `enable-ctrl-feat` command (for either 2000 or 3000 entries), the feature is also activated. This feature cannot be disabled with the `chg-ctrl-feat` command. The `chg-ctrl-feat` command cannot be used with this procedure.

1. Display the status of the XMAP Table Expansion feature by entering the `rtrv-ctrl-feat` command.

The following is an example of the possible output.

```
rlghncxa03w 06-10-28 21:15:37 GMT EAGLE5 36.0.0
The following features have been permanently enabled:
```

Feature Name	Partnum	Status	Quantity
Command Class Management	893005801	on	----
LNP Short Message Service	893006601	on	----
Intermed GTT Load Sharing	893006901	on	----
XGTT Table Expansion	893006101	on	400000
XMAP Table Expansion	893007710	off	----
Large System # Links	893005910	on	2000
Routesets	893006401	on	6000
HC-MIM SLK Capacity	893012707	on	64

The following features have been temporarily enabled:

Feature Name	Partnum	Status	Quantity	Trial
Period Left				
Zero entries found.				

The following features have expired temporary keys:

Feature Name	Partnum
Zero entries found.	

If the `rtrv-ctrl-feat` output shows that the feature is permanently enabled for the desired quantity or for a quantity that is greater than the desired quantity, no further action is necessary. This procedure does not need to be performed.

If the quantity shown for the XMAP Table Expansion feature is less than the desired quantity, skip steps 2 through 7, and go to step 8.

2. Display the cards in the EAGLE using the `rtrv-card` command.

The XMAP Table Expansion feature requires that service modules are in the database. This is an example of the possible output.

```
rlghncxa03w 13-05-25 09:58:31 GMT EAGLE5 45.0.0
CARD   TYPE      APPL      LSET NAME      PORT SLC LSET NAME
PORT SLC
1102   TSM         GLS
1113   E5MCAP     OAMHC
1114   E5TDM-A
1115   E5MCAP     OAMHC
1116   E5TDM-B
1117   E5MDAL
1201   LIMDS0     SS7ANSI   sp2             A    0    sp1
```

```

B      0
1203  LIMDS0    SS7ANSI    sp3          A      0
1204  LIMDS0    SS7ANSI    sp3          A      1
1206  LIMDS0    SS7ANSI    nsp3         A      1    nsp4
B      1
1308  LIMDS0    SS7ANSI    sp6          A      1    sp7
B      0
1314  LIMDS0    SS7ANSI    sp7          A      1    sp5
B      1

```

Service modules are shown by the entries SCCP or VSCCP in APPL column. If the `rtrv-card` output shows no service modules, Perform [Adding a Service Module](#) to add the necessary service modules.

3. Display the serial number in the database with the `rtrv-serial-num` command.

 **Note:**

If the `rtrv-ctrl-feat` output in [1](#) shows any controlled features, continue the procedure with [7](#). If the `rtrv-ctrl-feat` output shows only the HC-MIM SLK Capacity feature with a quantity of 64, [3](#) through [6](#) must be performed.

This is an example of the possible output.

```

rlghncxa03w 06-10-28 21:15:37 GMT EAGLE5 36.0.0
System serial number = nt00001231

```

System serial number is not locked.

```

rlghncxa03w 06-10-28 21:15:37 GMT EAGLE5 36.0.0
Command Completed.

```

4. Enter the correct serial number into the database using the `ent-serial-num` command with the `serial` parameter.

 **Note:**

If the serial number is correct and locked, continue the procedure with [7](#). If the serial number is correct but not locked, continue the procedure with [6](#). If the serial number is not correct, but is locked, this feature cannot be enabled and the remainder of this procedure cannot be performed. Contact the Customer Care Center to get an incorrect and locked serial number changed. Refer to [#unique_17](#) for the contact information. The serial number can be found on a label affixed to the control shelf (shelf 1100).

For this example, enter this command.

```
ent-serial-num:serial=<EAGLE's correct serial number>
```

When this command has successfully completed, the following message should appear.

```
rlghncxa03w 06-10-28 21:15:37 GMT EAGLE5 36.0.0  
ENT-SERIAL-NUM: MASP A - COMPLTD
```

5. Verify the serial number entered into step 4 was entered correctly using the `rtrv-serial-num` command.

This is an example of the possible output.

```
rlghncxa03w 06-10-28 21:15:37 GMT EAGLE5 36.0.0  
System serial number = nt00001231
```

System serial number is not locked.

```
rlghncxa03w 06-10-28 21:15:37 GMT EAGLE5 36.0.0  
Command Completed.
```

If the serial number was not entered correctly, repeat steps 4 and 5 and re-enter the correct serial number.

6. Lock the serial number in the database by entering the `ent-serial-num` command with the serial number shown in step 3, if the serial number shown in step 3 is correct, or with the serial number shown in step 5, if the serial number was changed in step 4, and with the `lock=yes` parameter.

For this example, enter this command.

```
ent-serial-num:serial=<EAGLE's serial number>:lock=yes
```

When this command has successfully completed, the following message should appear.

```
rlghncxa03w 06-10-28 21:15:37 GMT EAGLE5 36.0.0  
ENT-SERIAL-NUM: MASP A - COMPLTD
```

7. Enable the XMAP Table Expansion feature for the desired quantity with the `enable-ctrl-feat` command specifying the part number corresponding to the new quantity of entries for the mated application table and the feature access key.

For this example, enter one of these commands.

To increase the number of entries in the mated application table to 2000, enter this command.

```
enable-ctrl-feat:partnum=893007701:fak=<XMAP Table Expansion  
feature access key>
```

To increase the number of entries in the mated application table to 3000, enter this command.

```
enable-ctrl-feat:partnum=893007710:fak=<XMAP Table Expansion  
feature access key>
```



Note:

A temporary feature access key cannot be specified to enable this feature.



Note:

The values for the feature access key (the fak parameter) are provided. If you do not have the feature access key for the XMAP Table Expansion feature, contact your Sales Representative or Account Representative.

When the `enable-ctrl-feat` command has successfully completed, this message should appear.

```
rlghncxa03w 06-10-28 21:15:37 GMT EAGLE5 36.0.0
ENABLE-CTRL-FEAT: MASP B - COMPLTD
```

- Verify the changes by entering the `rtrv-ctrl-feat` command with the part number used in step 7.

Enter one of these commands.

```
rtrv-ctrl-feat:partnum=893007701
```

The following is an example of the possible output.

```
rlghncxa03w 06-10-28 21:15:37 GMT EAGLE5 36.0.0
The following features have been permanently enabled:
```

Feature Name	Partnum	Status	Quantity
XMAP Table Expansion	893007701	on	2000

The following features have been temporarily enabled:

Feature Name	Partnum	Status	Quantity	Trial
Period Left				
Zero entries found.				

The following features have expired temporary keys:

Feature Name	Partnum
Zero entries found.	

```
rtrv-ctrl-feat:partnum=893007710
```

The following is an example of the possible output.

```
rlghncxa03w 06-10-28 21:15:37 GMT EAGLE5 36.0.0
The following features have been permanently enabled:
```

Feature Name	Partnum	Status	Quantity
XMAP Table Expansion	893007710	on	3000

The following features have been temporarily enabled:

Feature Name	Partnum	Status	Quantity	Trial
Period Left				
Zero entries found.				

The following features have expired temporary keys:

Feature Name	Partnum
Zero entries found.	

9. Back up the new changes using the `chg-db:action=backup:dest=fixed` command.

These messages should appear, the active Maintenance and Administration Subsystem Processor (MASP) appears first.

```
BACKUP (FIXED) : MASP A - Backup starts on active MASP.  
BACKUP (FIXED) : MASP A - Backup on active MASP to fixed disk  
complete.  
BACKUP (FIXED) : MASP A - Backup starts on standby MASP.  
BACKUP (FIXED) : MASP A - Backup on standby MASP to fixed disk  
complete.
```

Figure 5-11 Enable the XMAP Table Expansion Feature - Sheet 1 of 3

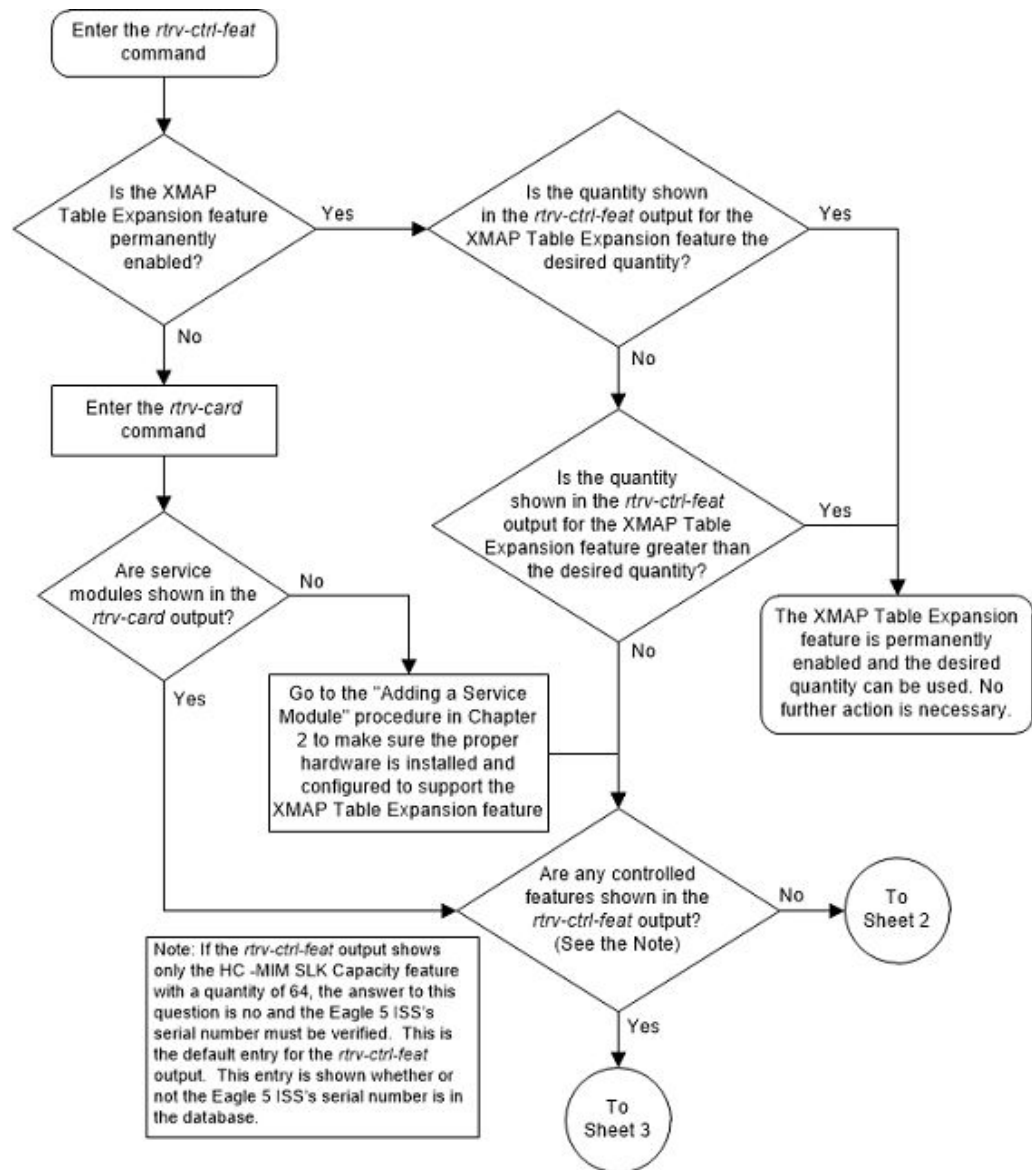

Figure 5-12 Enable the XMAP Table Expansion Feature - Sheet 2 of 3

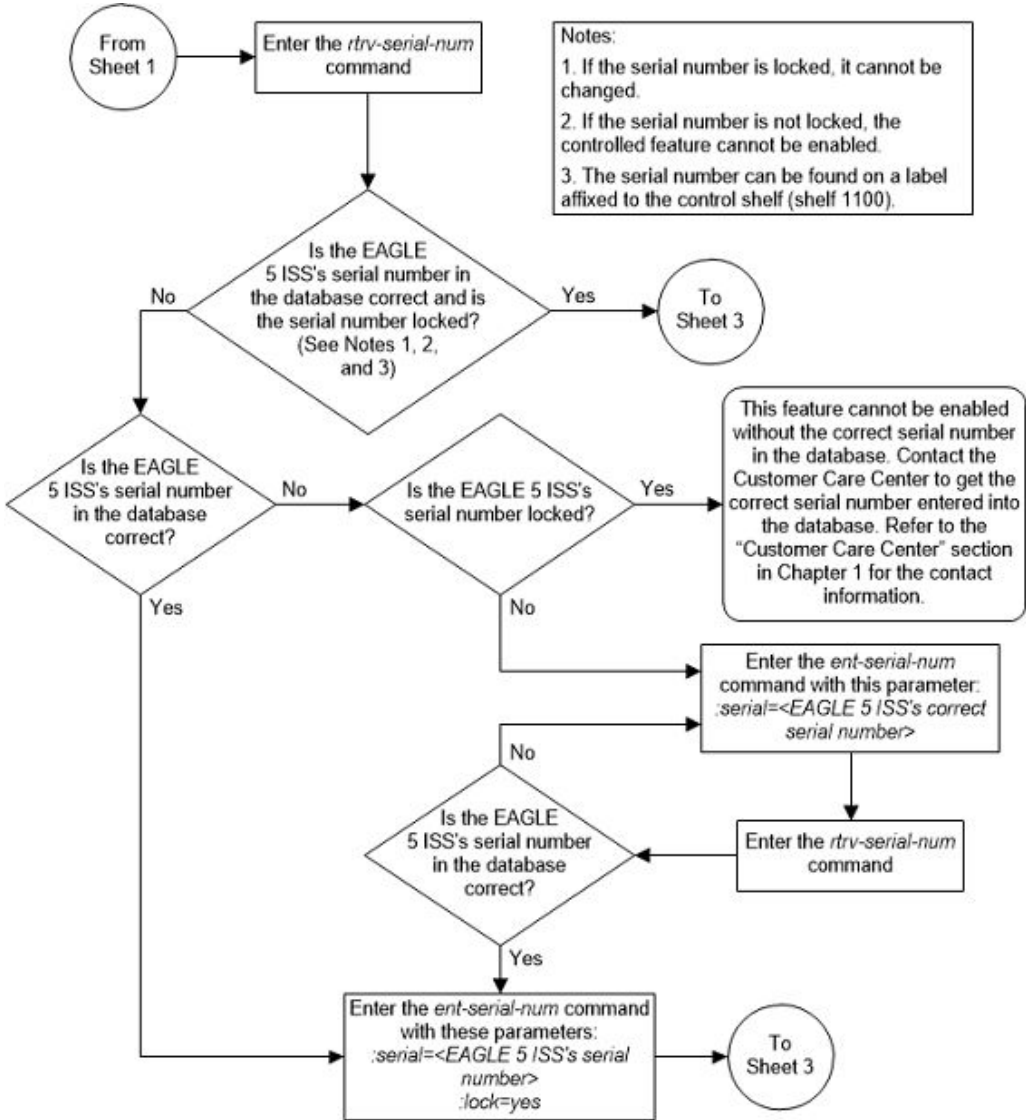
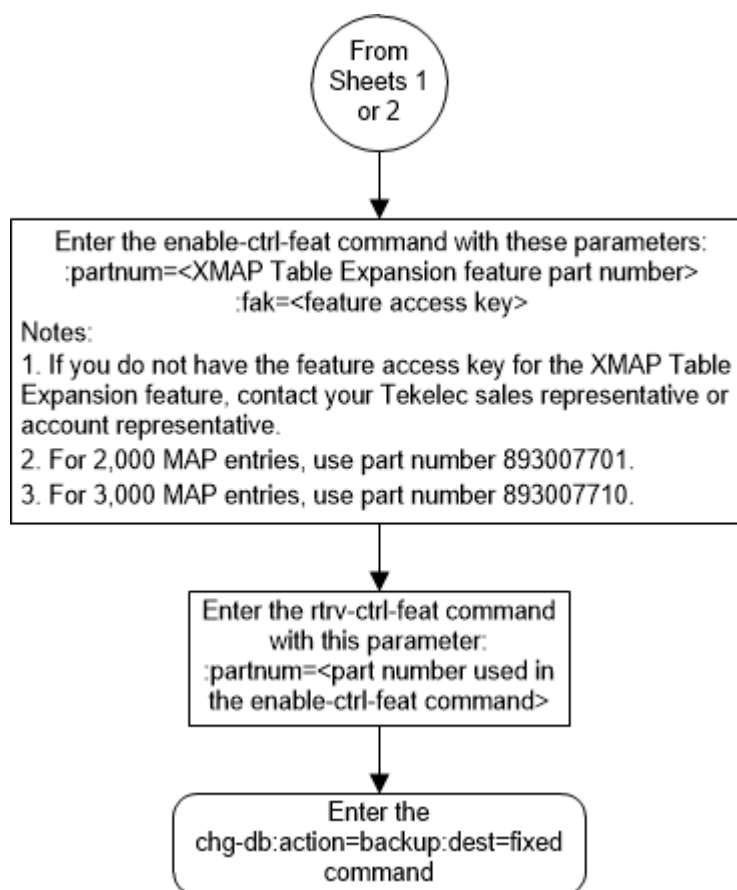

Figure 5-13 Enable the XMAP Table Expansion Feature - Sheet 3 of 3

Activating the EPAP Data Split and Dual ExAP Configuration Features

This procedure is used to enable and turn on the EPAP Data Split and Dual ExAP Configuration features using the feature part numbers.

Once the feature is turned ON, E5-SMxG card can be provisioned as either a DN card or IMSI card. On the DN card, DN, DN Block, ASD and Entity data is be loaded. On the IMSI card, IMSI, IMEI, IMEI Block and Entity data is loaded. The feature also provides the GTT data type. A maximum of 240 million of DN data is loaded on the DN cards and a maximum of 240 million of IMSI on IMSI cards. The total maximum capacity of 480 million data is supported system wide.

With the Dual ExAP Configuration feature, the EPAP-based features and ELAP-based features can be turned on (and process traffic) simultaneously on the same EAGLE. This feature is used to control the provisioning of E5-SMxG card to be EPAP, ELAP or GTT data types, and determine the table to download to the corresponding E5-SMxG. Another data type, GTT, is also assigned to E5-SMxG card if the corresponding E5-SMxG card does not download any tables from EPAP or ELAP.

Table 5-1 EAGLE Feature and EPAP DB Capacity Combinations

EPAP Split DB Feature	STPOPT S: EPAP 240M	Max Ind. DNs	Max Ind. IMSIs	Max Ind. DNs + Ind. IMSIs	Max Ind. IMEIs	SM Requires 64-bit GPLs?	Max RTDB Size (DN+IM SI+IMEI) supported on Ind. SM8G-B	Max RTDB Size (DN+IM SI+IMEI) supported on Ind. SLIC
OFF	OFF	120M	120M	120M	32M	No	120M	120M
ON	OFF	120M	120M	240M	32M	No	120M	120M
OFF	ON	240M	240M	240M	48M	Yes	240M	240M (240M DN + 240M IMSI)
ON	ON	240M	240M	480M	48M	Yes	240M	480M (420M DN + 240M IMSI)



Note:

*Use the `AUTO=YES` parameter with the `chg-ip-lnk` command to set ExAP Ports on SM (SMxG/SLIC) cards to auto negotiate the speed and duplex. Corresponding ports on EPAP LAN switches should be configured accordingly to achieve the required operational speed and duplex of 1Gbps and Full Duplex. Refer to *ExAP Administration Guide* for more information. Once the SM cards in service, the `pass:cmd="netstat -i":loc=<:SM card loc>` can be used to verify the operational speed and duplex of ExAP ports on SM cards.

Table 5-2 Reload Times For Cards Connected to EPAP With Cold Restart and 240M DN + 240M IMSI

Data Rate between EPAP and card	1 card (before 46.4)	Up to 32 cards (before 46.4)	From 33 up to 40 cards (46.5 and later)
100 Mbps	120 minutes	180 minutes	180 minutes
1 Gpbs	15 minutes	20 minutes	20 minutes

 **Note:**

The recommended data rate connection between EPAP and EAGLE is 1 Gbps. A 100 Mbps data rate connection between EPAP and EAGLE card is not recommended if the EPAP database has more than 120 DN or 120 IMSI or more than 32 cards connected to the EPAP. If 100 Mbps connections are used, the RTDB download time will increase substantially and can increase the download time by an hour or more, depending on the number of entries in the RTDB.

EPAP Data Split

The `enable-ctrl-feat` command enables the feature by inputting the feature's access key and the feature's part number with these parameters:

`chg-stpopts: on=mfc` if MFC has not been turned ON yet.

`: fak` – The feature access key provided. The feature access key contains 13 alphanumeric characters and is not case sensitive.

`: partnum` – The issued part number of the EPAP Data Split feature, 893039801.

The `enable-ctrl-feat` command requires that the database contain a valid serial number for the EAGLE, and that this serial number is locked. This can be verified with the `rtrv-serial-num` command. The EAGLE is shipped with a serial number in the database, but the serial number is not locked. The serial number can be changed, if necessary, and locked once the EAGLE is on-site, with the `ent-serial-num` command. The `ent-serial-num` command uses these parameters.

`: serial` – The serial number assigned to the EAGLE. The serial number is not case sensitive.

`: lock` – Specifies whether or not the serial number is locked. This parameter has only one value, `yes`, which locks the serial number. Once the serial number is locked, it cannot be changed.

The initial status of this feature is "disabled and off." This feature cannot be temporarily enabled (with the temporary feature access key).

Once this feature has been enabled, the feature must be activated with the `chg-ctrl-feat` command. The `chg-ctrl-feat` command uses these parameters:

`: partnum` – The issued part number of the Dual ExAP Configuration feature, 893039801.

`: status=on` – used to turn the Dual ExAP Configuration feature on.

 **Note:**

Once this feature has been turned on, it cannot be turned off.

The status of the features in the EAGLE is shown with the `rtrv-ctrl-feat` command.

For existing SMS, enter the following commands:

- `inh-card: loc=<SM location>`
- `chg-card:loc=<SM location>;data={DN/IMSI/GTT}`
- `alw-card:loc=<SM location>`
- `chg-db:action=backup` to backup the configuration

If GTTDIST=EPAP, the user must change GTTDIST to ALL, ELAP, DN or IMSI based on the availability of matching data type cards. If GTTDIST is to be changed directly to DN or IMSI from EPAP, then the change should be done when there are enough EPAP cards remaining to handle the GTT traffic load. There also needs to be sufficient DN or IMSI cards (in IS-NR state) to handle GTT traffic load or GTT traffic may be discarded.

To add new SMS, enter the following commands:

- `ent-card:loc=<SM location>;appl=vscpp:type=dsm:data={DN/IMSI/GTT}`
- `chg-ip-lnk` to configure the IP address to connect to the EPAP server
- `alw-card:loc=<SM location>`
- `chg-db:action=backup` to backup the configuration

Dual ExAP Configuration

The `enable-ctrl-feat` command enables the feature by inputting the feature's access key and the feature's part number with these parameters:

`chg-stpopts: on=mfc` if MFC has not been turned ON yet.

`: fak` – The feature access key provided. The feature access key contains 13 alphanumeric characters and is not case sensitive.

`: partnum` – The issued part number of the Dual ExAP Configuration feature, 893040501.

This feature is enabled and turned ON with in one step with the `enable-ctrl-feat` command.

Note:

The EPAP `data` parameter is allowed when RTDB Split Feature is enabled.

The initial status of this feature is "disabled and off." This feature cannot be temporarily enabled (with the temporary feature access key).

Once this feature is enabled, all existing SM cards will be automatically reconfigured as either ELAP cards (if the LNP feature was ON before Dual ExAP Config is enabled), or EPAP cards (if EPAP based feature is ON before Dual ExAP Config is enabled).

Once this feature has been enabled, the feature must be activated with the `chg-ctrl-feat` command. The `chg-ctrl-feat` command uses these parameters:

`: partnum` – The issued part number of the Dual ExAP Configuration feature, 893040501.

`: status=on` – used to turn the Dual ExAP Configuration feature on.

 **Note:**

Once this feature has been turned on, it cannot be turned off.

The status of the features in the EAGLE is shown with the `rtrv-ctrl-feat` command.

For existing SMS, enter the following commands:

- `inh-card: loc=<SM location>`
- `chg-card:loc=<SM location>:data={EPAP/ELAP/GTT}`
- `alw-card:loc=<SM location>`
- `chg-db:action=backup` to backup the configuration

To add new SMS, enter the following commands:

- `ent-card:loc=<SM location>:appl=vsccp:type=dsm:data={EPAP/ELAP/GTT}`
- `chg-ip-lnk` to configure the IP address to connect to the EPAP server
- `alw-card:loc=<SM location>`
- `chg-db:action=backup` to backup the configuration

Feature Activation At EPAP

By default the feature EPAP data split is OFF. The `uiEdit` tool is used to turn this ON. Execute following command to view the current value of configurable parameter: `$ /usr/TKLC/epap/bin/uiEdit EPAP_DATA_SPLIT`.

Execute following command to activate the feature: `$ /usr/TKLC/epap/bin/uiEdit EPAP_DATA_SPLIT ON`.

 **Note:**

After the previous command has been performed, restart the PDBA and the EPAP application to complete feature activation.

 **Note:**

Turning on the `EPAP_DATA_SPLIT` feature allows the 240M data to be provisioned and `EIR_BLK_EXPANSION_100k` will increase the provisioning capacity of EIR blocks from 50k to 100k.

EIR Block Expansion Feature

By default the feature EIR block expansion to 100K is OFF. The "uiEdit" tool is used to turn this ON. Execute following command to view the current value of configurable parameter: `$ /usr/TKLC/epap/bin/uiEdit EIR_BLK_EXPANSION_100K`.

Execute following command to activate the feature: `$ /usr/TKLC/epap/bin/uiEdit EIR_BLK_EXPANSION_100K ON.`



Note:

After the previous command has been performed, restart the PDBA or send SIGHUP signal to PDBA to complete feature activation.



Note:

To enter and lock the EAGLE's serial number, the `ent-serial-num` command must be entered twice, once to add the correct serial number to the database with the `serial` parameter, then again with the `serial` and the `lock=yes` parameters to lock the serial number. The user should verify that the serial number in the database is correct before locking the serial number. The serial number can be found on a label affixed to the control shelf (shelf 1100).

Activating the EPAPX DB Expansion Feature

When EPAP is running on release 16.3 with its full capacity, DN-based SLIC-SCCP cards are able to load 480M individual DN entries. IMSI-based SLIC-SCCP cards are able to load 600M individual IMSI entries or 600M individual IMEI entries. This is applicable when the EPAP Split DB feature is ON. DB allocation to EAGLE EPAP-based cards are flexible, as per the configurations done on the EPAP side.



Note:

Once the STPOPTS:EPAPX feature is enabled, STPOPTS:EPAP240M cannot be enabled.

If the EPAP Split DB feature is OFF, then the DN & IMSI tables are loaded onto a single EPAP card. In this case the DN + IMSI entries must be less than 480M. The exact allowed combinations are listed in the following table:



Note:

Table 5-3 details the card configuration as in `data=<dn/imsi/epap>`.

Table 5-3 EAGLE Feature and EPAPX DB Capacity Combinations

EPAP Split DB Feature	STPOPTS: EPAPX	Max Ind. DNs	Max Ind. IMSIs	Max Ind. DNs + Ind. IMSIs	Max Ind. IMEIs	Max RTDB Size (DN+IMSI+IMEI) Supported on Ind. SLIC
OFF	OFF EPAP240M OFF	120M	120M	120M	48M	120M for DN card 135M for IMSI card
ON	OFF EPAP240M OFF	120M	120M	240M	48M	120M for DN card 135M for IMSI card
ON	OFF EPAP240M ON	240M	240M	480M	48M	240M for DN card 288M for IMSI card 528M for EPAP card
OFF	ON	480M	480M	480M	480M	480M (DN + IMSI + IMEI)
ON	ON	480M	600M	1080M	600M	480M for DN card 600M for IMSI card

To enable the 480M DN & 600M IMSI/600M IMEI capacity expansion on EAGLE, the `epapx` parameter is introduced in the STPOPTS table. The SLIC-SCCP cards on EAGLE are able to load 480M DN entries only when the STPOPTS: EPAPX parameter is ON. Similarly, SLIC-SCCP cards on EAGLE are able to load 600M IMSI or 600M IMEI entries only when the STPOPTS: EPAPX parameter is ON.

 **Note:**

The STPOPTS:EPAPX feature can only be turned ON if all EPAP-based SCCP cards are SLIC cards running 64-bit GPLs, and all other types of EPAP-based SCCP cards, including SMxG cards and SLIC cards running 32-bit GPLs, are either inhibited or deleted from the EAGLE. Once turned ON, it is not possible to turn OFF the option manually.

 **Note:**

Turning on the EPAPX DB Expansion feature allows the 480M data to be provisioned and the DN block capacity will be 400k.

Execute these steps to activate the EPAPX DB Expansion feature.

1. If EAGLE is currently configured with these parameters, then the SM cards need to be re-configured to use the EPAP Data Split feature with at least one SM card data=DN and at least one SM card data=IMSI by using the `chg-card` command.
 - EPAP Split DB Feature is ON, and
 - STPOPTS:EPAP240M is ON, and
 - SM cards are configured with data=EPAP, and
 - RTDB size is > 480M (calculated by summing the DN/IMSI/IMEI data counts in the RTDB:View RTDB Status from the EPAP's GUI)
2. If the EPAP is configured as a Mixed EPAP, then convert the EPAPs to a Standalone PDB EPAP and non-Provisioning EPAPs configuration. Refer to the Standalone PDB EPAP Configuration Procedure in the *EPAP Administration Guide*.
3. Back up the EAGLE database using the instructions found in the *Database Administration – System Management User's Guide*.
4. Use the `chg-stpopts:on=epapx` command to turn ON the functionality for the EPAPX DB Expansion feature.
5. Use the `rtrv-stpopts` command to check the current status of the STPOPTS EPAPX option.
6. Change the EPAP's database architecture to eXtreme. Refer to the *EPAP Upgrade/Installation Guide* for detailed instructions.
7. Boot EAGLE's SM card to load the EPAP database using the new EPAPX schema.

Activating the ANSI/ITU SCCP Conversion Feature

This procedure is used to enable and turn on the ANSI/ITU SCCP Conversion feature using the feature's part number.

The `enable-ctrl-feat` command enables the feature by inputting the feature's access key and the feature's part number with these parameters:

`:partnum` – The issued part number of the ANSI/ITU SCCP Conversion feature, 893012001.

The `enable-ctrl-feat` command requires that the database contain a valid serial number for the EAGLE, and that this serial number is locked. This can be verified with the `rtrv-serial-num` command. The EAGLE is shipped with a serial number in the database, but the serial number is not locked. The serial number can be changed, if necessary, and locked once the EAGLE is on-site, with the `ent-serial-num` command. The `ent-serial-num` command uses these parameters.

`:serial` – The serial number assigned to the EAGLE. The serial number is not case sensitive.

`:lock` – Specifies whether or not the serial number is locked. This parameter has only one value, `yes`, which locks the serial number. Once the serial number is locked, it cannot be changed.

 **Note:**

To enter and lock the EAGLE's serial number, the `ent-serial-num` command must be entered twice, once to add the correct serial number to the database with the `serial` parameter, then again with the `serial` and the `lock=yes` parameters to lock the serial number. You should verify that the serial number in the database is correct before locking the serial number. The serial number can be found on a label affixed to the control shelf (shelf 1100).

This feature cannot be temporarily enabled (with the temporary feature access key).

Once this feature has been enabled, the feature must be activated with the `chg-ctrl-feat` command. The `chg-ctrl-feat` command uses these parameters:

`:partnum` – The issued part number of the ANSI/ITU SCCP Conversion feature, 893012001.

`:status=on` – used to turn the ANSI/ITU SCCP Conversion feature on.

 **Note:**

Once this feature has been turned on, it cannot be turned off.

The status of the features in the EAGLE is shown with the `rtrv-ctrl-feat` command.

The ANSI/ITU SCCP Conversion feature requires that the Global Title Translation (GTT) feature is turned on with the `chg-feat` command using the `gtt=on` parameters.

 **Note:**

Once the Global Title Translation feature is turned on with the `chg-feat` command, it cannot be turned off.

The Global Title Translation feature must be purchased before it can be turned on. If you are not sure whether you have purchased the Global Title Translation feature, contact your Sales Representative or Account Representative.

The ANSI/ITU SCCP Conversion feature requires that service modules are installed and provisioned in the EAGLE. Service modules are E5-SM4G or E5-SM8G-B cards. SLIC cards may also be used. DSM cards are shown by the entry `dsm` in the `TYPE` column and `vsccp` in the `APPL` column of the `rtrv-card` output. SLIC cards are shown as `type=dsm` or `type=slic` and `appl=vsccp`.

The ANSI/ITU SCCP Conversion feature cannot be enabled if either the SCCPCNV or TCAPCNV features are on. This can be verified by entering the `rtrv-feat` command. If the SCCPCNV feature is on, the SCCPCNV field is set to `on`. If the TCAPCNV feature is on, the TCAPCNV field is set to `on`. If either the SCCPCNV

or TCAPCNV features are on, the ANSI/ITU SCCP Conversion feature cannot be enabled and this procedure cannot be performed. If either of these features are on and you wish to enable the ANSI/ITU SCCP Conversion feature, contact the Customer Care Center. Refer to [#unique_17](#) section for the contact information.

1. Display the status of the controlled features by entering the `rtrv-ctrl-feat` command.

The following is an example of the possible output.

```
rlghncxa03w 06-10-28 21:15:37 GMT EAGLE5 36.0.0
The following features have been permanently enabled:
```

Feature Name	Partnum	Status	Quantity
Command Class Management	893005801	on	----
LNP Short Message Service	893006601	on	----
Intermed GTT Load Sharing	893006901	on	----
XGTT Table Expansion	893006101	on	400000
XMAP Table Expansion	893007710	off	----
Large System # Links	893005910	on	2000
Routesets	893006401	on	6000
HC-MIM SLK Capacity	893012707	on	64

The following features have been temporarily enabled:

Feature Name	Partnum	Status	Quantity	Trial Period Left
Zero entries found.				

The following features have expired temporary keys:

Feature Name	Partnum
Zero entries found.	

If the ANSI/ITU SCCP Conversion feature (shown in the `rtrv-ctrl-feat` output as SCCP Conversion) is enabled and on, no further action is necessary. This procedure does not need to be performed.

If the ANSI/ITU SCCP Conversion feature is enabled and but not on, skip steps 2 through 8 and go to step 9.

2. Verify whether or not the SCCPCNV or TCAPCNV features are on by entering the `rtrv-feat` command.

If the SCCPCNV feature is on, the `SCCPCNV` field is set to `on`. If the TCAPCNV feature is on, the `TCAPCNV` field is set to `on`.

 **Note:**

The `rtrv-feat` command output contains other fields that are not used by this procedure. If you wish to see all the fields displayed by the `rtrv-feat` command, see the `rtrv-feat` command description in *Commands User's Guide*.

 **Note:**

If either the SCCPCNV or TCAPCNV features are on, the ANSI/ITU SCCP Conversion feature cannot be enabled and this procedure cannot be performed. If either of these features are on and you wish to enable the ANSI/ITU SCCP Conversion feature, contact [#unique_17](#). Refer to [#unique_17](#) section for the contact information.

 **Note:**

If the `rtrv-ctrl-feat` output in step 1 or the `rtrv-feat` output in step 2 shows that any of the features shown in [Adding a Service Module](#) are enabled or turned on, skip step 3 and go to step 4.

 **Note:**

If the `rtrv-feat` output in step 2 shows that the GTT feature is not on, perform the [Adding a Service Module](#) procedure to turn the GTT feature on and to add the appropriate service modules, according to the [Adding a Service Module](#) procedure, to support the GTT and ANSI/ITU SCCP Conversion features. Skip step 3 and go to step 4.

3. Display the cards in the EAGLE using the `rtrv-card` command.

The ANSI/ITU SCCP Conversion feature requires that service modules are in the database. This is an example of the possible output.

```
rlghncxa03w 06-05-25 09:58:31 GMT EAGLE5 45.0.0
CARD   TYPE      APPL      LSET NAME      PORT SLC LSET NAME
PORT SLC
1102   TSM         GLS
1113   E5MCAP     OAMHC
1114   E5TDM-A
1115   E5MCAP     OAMHC
1116   E5TDM-B
1117   E5MDAL
1201   LIMDS0     SS7ANSI   sp2             A    0    sp1
B      0
1203   LIMDS0     SS7ANSI   sp3             A    0
1204   LIMDS0     SS7ANSI   sp3             A    1
1206   LIMDS0     SS7ANSI   nsp3            A    1    nsp4
B      1
1308   LIMDS0     SS7ANSI   sp6             A    1    sp7
B      0
1314   LIMDS0     SS7ANSI   sp7             A    1    sp5
B      1
```

DSM cards are shown by the entry `dsm` in the `TYPE` column and `vscpp` in the `APPL` column of the `rtrv-card` output. SLIC cards are shown as `type=dsm` (in

the odd numbered card slots) or `type=slic` (in the even numbered card slots), and `appl=vsccp`.

If the appropriate service modules are in the EAGLE (see the [Adding a Service Module](#) procedure), go to step 4.

4. Display the serial number in the database with the `rtrv-serial-num` command.

 **Note:**

If the `rtrv-ctrl-feat` output in step 1 shows any controlled features, skip steps 4 through 7, and go to step 8. If the `rtrv-ctrl-feat` output shows only the HC-MIM SLK Capacity feature with a quantity of 64, steps 4 through 7 must be performed.

This is an example of the possible output.

```
rlghncxa03w 06-10-28 21:15:37 GMT EAGLE5 36.0.0
System serial number = nt00001231
```

System serial number is not locked.

```
rlghncxa03w 06-10-28 21:15:37 GMT EAGLE5 36.0.0
Command Completed
```

5. Enter the correct serial number into the database using the `ent-serial-num` command with the `serial` parameter.

 **Note:**

If the serial number is correct and locked, skip steps 5, 6, and 7, and go to step 8. If the serial number is correct but not locked, skip steps 5 and 6, and go to step 7. If the serial number is not correct, but is locked, this feature cannot be enabled and the remainder of this procedure cannot be performed. Contact My Oracle Support to get an incorrect and locked serial number changed. Refer to [#unique_17](#) for the contact information. The serial number can be found on a label affixed to the control shelf (shelf 1100).

For this example, enter this command.

```
ent-serial-num:serial=<EAGLE's correct serial number>
```

When this command has successfully completed, the following message should appear.

```
rlghncxa03w 06-10-28 21:15:37 GMT EAGLE5 36.0.0
ENT-SERIAL-NUM: MASP A - COMPLTD
```

6. Verify the serial number entered into step 5 was entered correctly using the `rtrv-serial-num` command. This is an example of the possible output.

```
rlghncxa03w 06-10-28 21:15:37 GMT EAGLE5 36.0.0
System serial number = nt00001231
```

```
System serial number is not locked.
```

```
rlghncxa03w 06-10-28 21:15:37 GMT EAGLE5 36.0.0
Command Completed
```

If the serial number was not entered correctly, repeat steps 4 and 5 and re-enter the correct serial number.

7. Lock the serial number in the database by entering the `ent-serial-num` command with the serial number shown in step 4, if the serial number shown in step 4 is correct, or with the serial number shown in step 6, if the serial number was changed in step 5, and with the `lock=yes` parameter.

For this example, enter this command.

```
ent-serial-num:serial=<EAGLE's serial number>:lock=yes
```

When this command has successfully completed, the following message should appear.

```
rlghncxa03w 06-10-28 21:15:37 GMT EAGLE5 36.0.0
ENT-SERIAL-NUM: MASP A - COMPLTD
```

8. Enable the ANSI/ITU SCCP Conversion feature with the `enable-ctrl-feat` command specifying the part number for the ANSI/ITU SCCP Conversion. Enter this command.

```
enable-ctrl-feat:partnum=893012001
```

When the `enable-ctrl-feat` command has successfully completed, this message should appear.

```
rlghncxa03w 06-10-28 21:15:37 GMT EAGLE5 36.0.0
ENABLE-CTRL-FEAT: MASP B - COMPLTD
```

9. Turn the ANSI/ITU SCCP Conversion feature on with the `chg-ctrl-feat` command specifying the part number for the ANSI/ITU SCCP Conversion and the `status=on` parameter. Enter this command.

```
chg-ctrl-feat:partnum=893012001:status=on
```

 **Note:**

Once the ANSI/ITU SCCP Conversion feature is turned on, it cannot be turned off.

 **Note:**

The called party/calling party address indicator bit in the MSU may be modified as soon as the ANSI/ITU SCCP Conversion is enabled and turned on, depending on the destination network of the MSU. If the MSU is sent to an ITU-I network, the value of the called party/calling party address indicator bit in the MSU may be changed to 0. If the MSU is sent to an ANSI or ITU-N network, the value of the called party/calling party address indicator bit in the MSU may be changed to 1. If you wish to set the value of the called party/calling party address indicator bit in the MSU after the ANSI/ITU SCCP Conversion is enabled and turned on, perform the [Configuring the ANSI to ITU-N SCCP Conversion Option](#) procedure.

When the `chg-ctrl-feat` command has successfully completed, this message should appear.

```
rlghncxa03w 06-10-28 21:15:37 GMT EAGLE5 36.0.0
CHG-CTRL-FEAT: MASP B - COMPLTD
```

10. Verify the changes by entering the `rtrv-ctrl-feat` command with the ANSI/ITU SCCP Conversion feature part number. Enter this command.

```
rtrv-ctrl-feat:partnum=893012001
```

The following is an example of the possible output.

```
rlghncxa03w 06-10-28 21:15:37 GMT EAGLE5 36.0.0
The following features have been permanently enabled:
```

Feature Name	Partnum	Status	Quantity
SCCP Conversion	893012001	on	----

The following features have been temporarily enabled:

Feature Name	Partnum	Status	Quantity	Trial
Period Left				
Zero entries found.				

The following features have expired temporary keys:

Feature Name	Partnum
Zero entries found.	

11. Back up the new changes using the `chg-db:action=backup:dest=fixed` command. These messages should appear, the active Maintenance and Administration Subsystem Processor (MASP) appears first.

```
BACKUP (FIXED) : MASP A - Backup starts on active MASP.
BACKUP (FIXED) : MASP A - Backup on active MASP to fixed disk
complete.
BACKUP (FIXED) : MASP A - Backup starts on standby MASP.
BACKUP (FIXED) : MASP A - Backup on standby MASP to fixed disk
complete.
```

Figure 5-14 Activate the ANSI/ITU SCCP Conversion Feature - Sheet 1 of 3

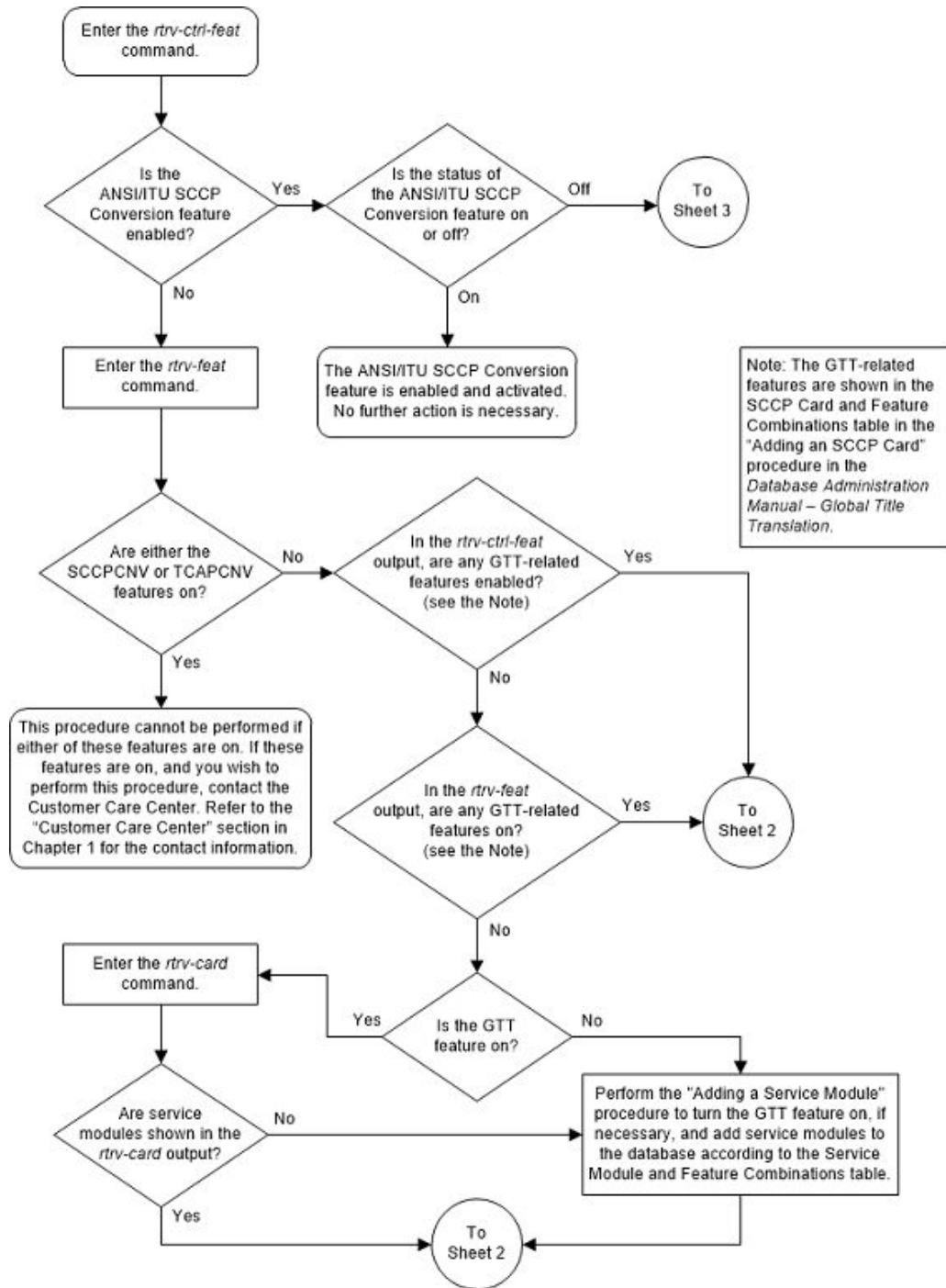

Figure 5-15 Activate the ANSI/ITU SSCP Conversion Feature - Sheet 2 of 3

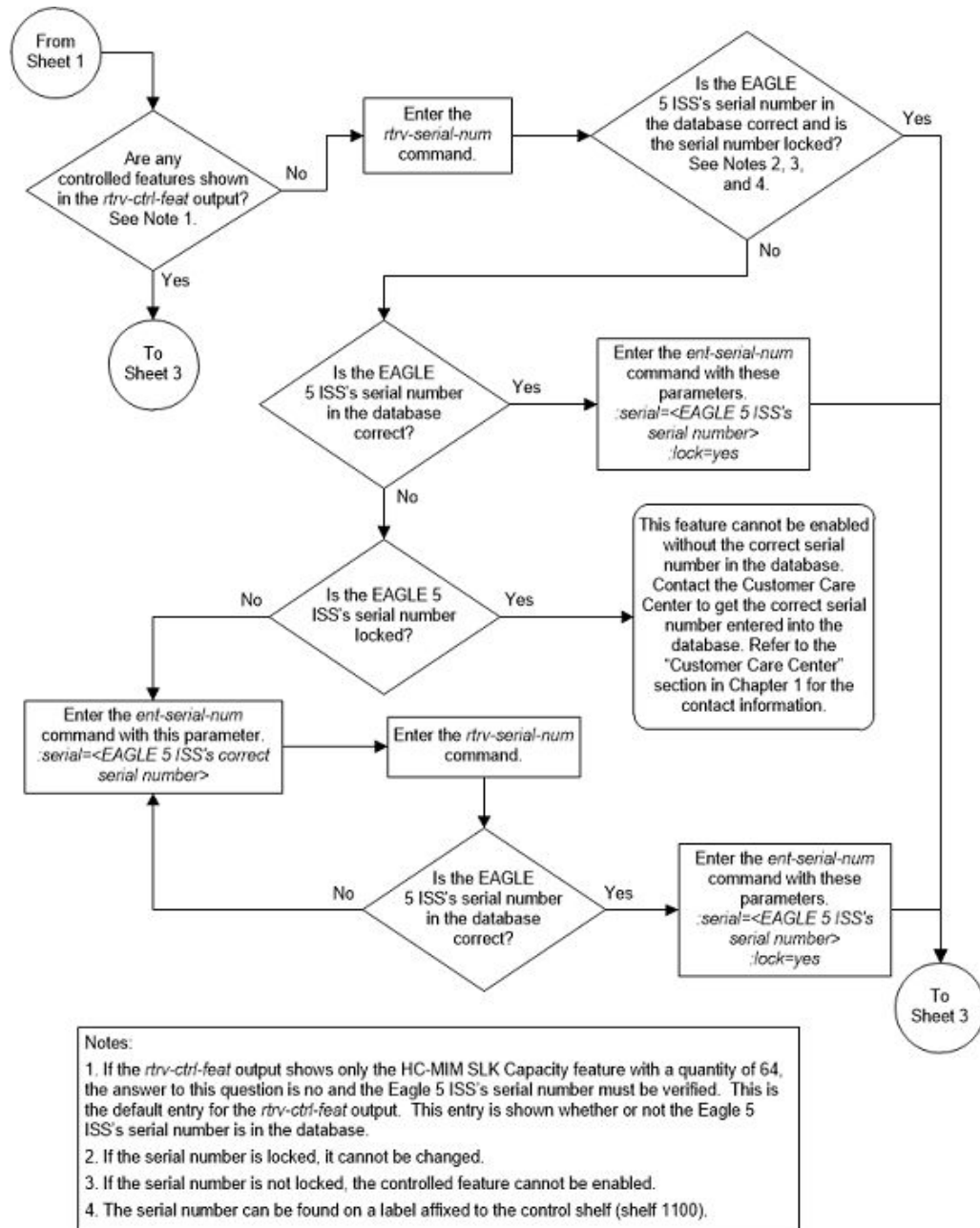
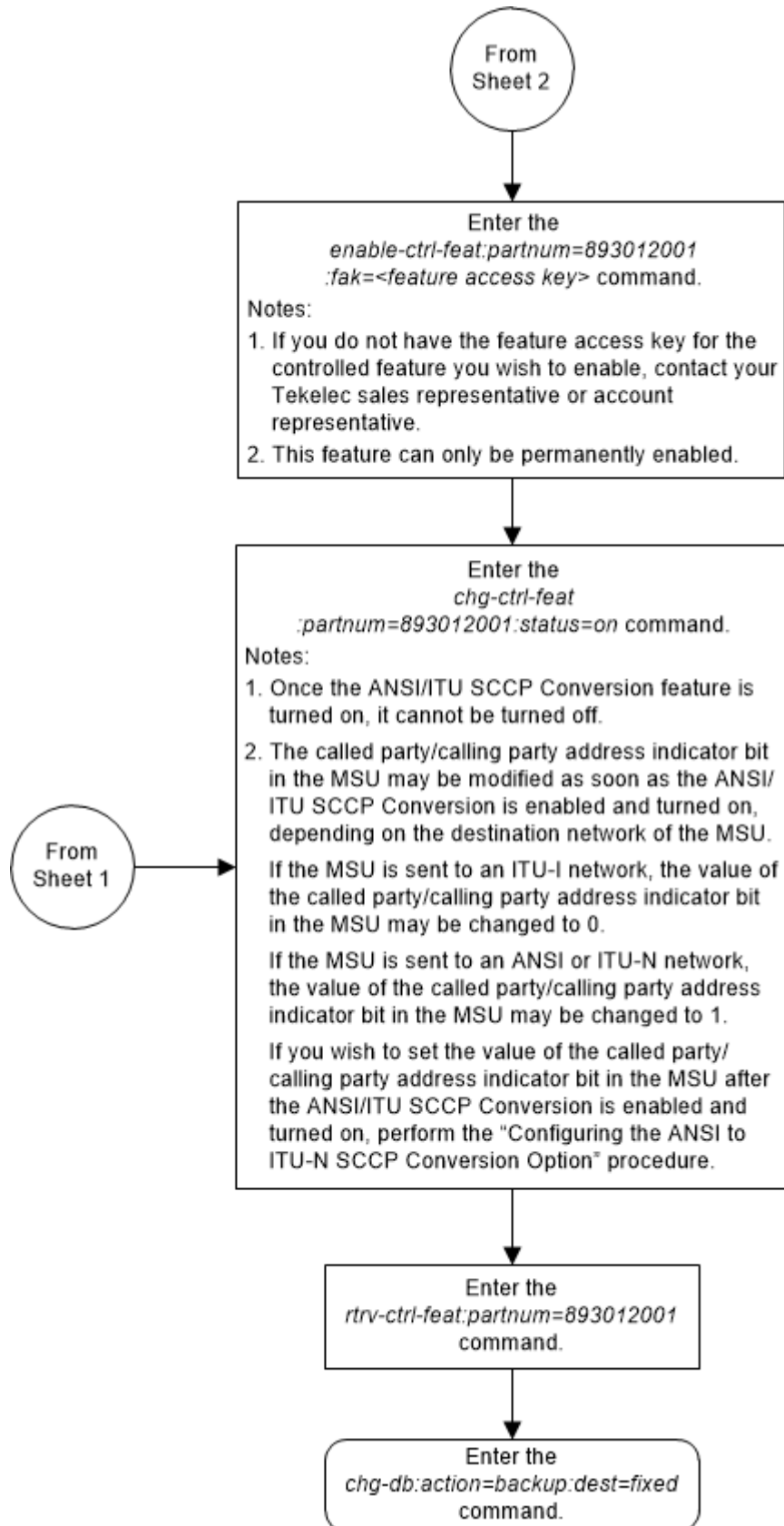

Figure 5-16 Activate the ANSI/ITU SCCP Conversion Feature - Sheet 3 of 3



Activating the Flexible GTT Load Sharing Feature

This procedure is used to enable and turn on the Flexible GTT Load Sharing feature using the feature's part number and a feature access key.

The feature access key for the Flexible GTT Load Sharing feature is based on the feature's part number and the serial number of the EAGLE 5, making the feature access key site-specific.

The `enable-ctrl-feat` command enables the feature by inputting the feature's access key and the feature's part number with these parameters:

`:fak` – The feature access key generated by the feature access key generator. The feature access key contains 13 alphanumeric characters and is not case sensitive.

`:partnum` – The issued part number of the Flexible GTT Load Sharing feature, 893015401.

The `enable-ctrl-feat` command requires that the database contain a valid serial number for the EAGLE 5, and that this serial number is locked. This can be verified with the `rtrv-serial-num` command. The EAGLE 5 is shipped with a serial number in the database, but the serial number is not locked. The serial number can be changed, if necessary, and locked once the EAGLE 5 is on-site, with the `ent-serial-num` command. The `ent-serial-num` command uses these parameters.

`:serial` – The serial number assigned to the EAGLE. The serial number is not case sensitive.

`:lock` – Specifies whether or not the serial number is locked. This parameter has only one value, `yes`, which locks the serial number. Once the serial number is locked, it cannot be changed.

Note:

To enter and lock the EAGLE 5's serial number, the `ent-serial-num` command must be entered twice, once to add the correct serial number to the database with the `serial` parameter, then again with the `serial` and the `lock=yes` parameters to lock the serial number. You should verify that the serial number in the database is correct before locking the serial number. The serial number can be found on a label affixed to the control shelf (shelf 1100).

This feature cannot be temporarily enabled (with the temporary feature access key).

Once this feature is enabled, provisioning for this feature can be performed, but the feature will not work until the feature is turned on with the `chg-ctrl-feat` command.

Once this feature has been enabled, the feature must be turned on with the `chg-ctrl-feat` command. The `chg-ctrl-feat` command uses these parameters:

`:partnum` – The issued part number of the Flexible GTT Load Sharing feature, 893015401.

`:status=on` – used to turn the Flexible GTT Load Sharing feature on.

Once the Flexible GTT Load Sharing feature has been turned on, it can be turned off. For more information on turning the Flexible GTT Load Sharing feature off, go to the [Turning Off the Flexible GTT Load Sharing Feature](#) procedure.

The status of the features in the EAGLE 5 is shown with the `rtrv-ctrl-feat` command.

The Flexible GTT Load Sharing feature requires that DSMs or SLIC cards are installed and provisioned in the EAGLE. DSM cards are shown by the entry `dsm` in the `TYPE` column and `vsccp` in the `APPL` column of the `rtrv-card` output. SLIC cards are shown as `type=dsm` (in the odd numbered card slots) or `type=slic` (in the even numbered card slots), and `appl=vsccp`.

1. Display the status of the controlled features by entering the `rtrv-ctrl-feat` command. The following is an example of the possible output.

```
rlghncxa03w 06-10-28 21:15:37 GMT EAGLE5 36.0.0
The following features have been permanently enabled:
```

Feature Name	Partnum	Status	Quantity
Command Class Management	893005801	on	----
LNP Short Message Service	893006601	on	----
Intermed GTT Load Sharing	893006901	on	----
XGTT Table Expansion	893006101	on	400000
XMAP Table Expansion	893007710	off	----
Large System # Links	893005910	on	2000
Routesets	893006401	on	6000
HC-MIM SLK Capacity	893012707	on	64

The following features have been temporarily enabled:

Feature Name	Partnum	Status	Quantity	Trial Period Left
Zero entries found.				

The following features have expired temporary keys:

Feature Name	Partnum
Zero entries found.	

If the Flexible GTT Load Sharing feature is enabled and turned on, no further action is necessary. This procedure does not need to be performed.

If the Flexible GTT Load Sharing feature is enabled and but not turned on, skip steps 2 through 8 and go to step 9.

If the Flexible GTT Load Sharing feature is not enabled, go to step 2.

2. Display the cards in the EAGLE 5 using the `rtrv-card` command.

The Flexible GTT Load Sharing feature requires that DSMs or SLIC cards running the VSCCP application are in the database. This is an example of the possible output.

```
rlghncxa03w 13-05-25 09:58:31 GMT EAGLE5 45.0.0
CARD  TYPE      APPL      LSET NAME      PORT SLC LSET NAME
PORT SLC
```

```

1102   TSM          GLS
1113   E5MCAP       OAMHC
1114   E5TDM-A
1115   E5MCAP       OAMHC
1116   E5TDM-B
1117   E5MDAL
1201   LIMDS0      SS7ANSI   sp2           A    0    sp1
B      0
1203   LIMDS0      SS7ANSI   sp3           A    0
1204   LIMDS0      SS7ANSI   sp3           A    1
1206   LIMDS0      SS7ANSI   nsp3          A    1    nsp4
B      1
1301   DSM         VSCCP
1303   DSM         VSCCP
1305   DSM         VSCCP
1308   LIMDS0      SS7ANSI   sp6           A    1    sp7
B      0
1314   LIMDS0      SS7ANSI   sp7           A    1    sp5
B      1

```

DSM (E5-SM4G and E5-SM8G-B) cards and SLIC cards run the VSCCP application.

DSMs, E5-SM4G, and E5-SM8G-B cards are shown by the entries DSM in the TYPE column and VSCCP in the APPL column.

If no service modules are shown in the `rtrv-card` output, perform [Adding a Service Module](#) to add DSMs to the EAGLE.

If DSMs running the VSCCP application are in the EAGLE, go to step 4.

 **Note:**

If the `rtrv-ctrl-feat` output in step 1 shows any controlled features, skip steps 3 through 6, and go to step 7. If the `rtrv-ctrl-feat` output shows only the HC-MIM SLK Capacity Feature with a quantity of 64, steps 3 through 6 must be performed.

3. Display the serial number in the database with the `rtrv-serial-num` command. This is an example of the possible output.

```

rlghncxa03w 06-10-28 21:15:37 GMT EAGLE5 36.0.0
System serial number = nt00001231

```

System serial number is not locked.

```

rlghncxa03w 06-10-28 21:15:37 GMT EAGLE5 36.0.0
Command Completed.

```

 **Note:**

If the serial number is correct and locked, skip steps 4, 5, and 6, and go to step 7. If the serial number is correct but not locked, skip steps 4 and 5, and go to step 6. If the serial number is not correct, but is locked, this feature cannot be enabled and the remainder of this procedure cannot be performed. Contact My Oracle Support to get an incorrect and locked serial number changed. Refer to [#unique_17](#) for the contact information. The serial number can be found on a label affixed to the control shelf (shelf 1100).

4. Enter the correct serial number into the database using the `ent-serial-num` command with the `serial` parameter.

For this example, enter this command.

```
ent-serial-num:serial=<EAGLE's correct serial number>
```

When this command has successfully completed, the following message should appear.

```
rlghncxa03w 06-10-28 21:15:37 GMT EAGLE5 36.0.0  
ENT-SERIAL-NUM: MASP A - COMPLTD
```

5. Verify that the serial number entered into step 4 was entered correctly using the `rtrv-serial-num` command. This is an example of the possible output.

```
rlghncxa03w 06-10-28 21:15:37 GMT EAGLE5 36.0.0  
System serial number = nt00001231
```

System serial number is not locked.

```
rlghncxa03w 06-10-28 21:15:37 GMT EAGLE5 36.0.0  
Command Completed.
```

If the serial number was not entered correctly, repeat steps 4 and 5 and re-enter the correct serial number.

6. Lock the serial number in the database by entering the `ent-serial-num` command with the serial number shown in step 3, if the serial number shown in step 3 is correct, or with the serial number shown in step 5, if the serial number was changed in step 4, and with the `lock=yes` parameter.

For this example, enter this command.

```
ent-serial-num:serial=<EAGLE's serial number>:lock=yes
```

When this command has successfully completed, the following message should appear.

```
rlghncxa03w 06-10-28 21:15:37 GMT EAGLE5 36.0.0  
ENT-SERIAL-NUM: MASP A - COMPLTD
```

 **Note:**

If the `ri=gt` parameter will not be used for GTT (with the `ent-/chg-gtt` commands) or GTA (with the `ent-/chg-gta` commands) provisioning, or if the `rtrv-ctrl-feat` output in step 1 shows the Intermediate GTT Load Sharing feature is enabled and turned on, skip this step and go to step 8.

7. To use the `ri=gt` parameter with the GTT or GTA provisioning when the Flexible GTT Load Sharing feature is enabled, the Intermediate GTT Load Sharing feature must be enabled and turned on.

Perform the [Activating the IGTTLS feature](#) procedure to enable and turn on the Intermediate GTT Load Sharing feature.

8. Enable the Flexible GTT Load Sharing feature with the `enable-ctrl-feat` command specifying the part number for the Flexible GTT Load Sharing feature. Enter this command.

```
enable-ctrl-feat:partnum=893015401
```

 **Note:**

The Flexible GTT Load Sharing feature cannot be enabled with a temporary feature access key.

When the `enable-ctrl-feat` command has successfully completed, this message should appear.

```
rlghncxa03w 06-10-28 21:15:37 GMT EAGLE5 36.0.0  
ENABLE-CTRL-FEAT: MASP B - COMPLTD
```

 **Caution:**

Once the Flexible GTT Load Sharing feature is enabled, provisioning for Flexible Intermediate GTT Load Sharing, using the `ent-mrn`, `dlt-mrn`, `chg-mrn`, and `rtrv-mrn` commands, can be performed, but the EAGLE will not perform Flexible Intermediate GTT Load Sharing on GTT traffic requiring intermediate global title translation until the Flexible GTT Load Sharing is turned on in [Activating the Flexible GTT Load Sharing Feature](#) .

▲ Caution:

Once the Flexible GTT Load Sharing feature is enabled, provisioning for Flexible Final GTT Load Sharing, using the `ent-map`, `dlt-map`, `chg-map`, and `rtrv-map` commands, can be performed, but the EAGLE will not perform Flexible Final GTT Load Sharing on GTT traffic requiring final global title translation until the Flexible GTT Load Sharing is turned on in [Activating the Flexible GTT Load Sharing Feature](#).

- Turn the Flexible GTT Load Sharing feature on with the `chg-ctrl-feat` command specifying the part number for the Flexible GTT Load Sharing feature and the `status=on` parameter. Enter this command.

```
chg-ctrl-feat:partnum=893015401:status=on
```

When the `chg-ctrl-feat` command has successfully completed, this message should appear.

```
rlghncxa03w 06-10-28 21:15:37 GMT EAGLE5 36.0.0
CHG-CTRL-FEAT: MASP B - COMPLTD
```

- Verify the changes by entering the `rtrv-ctrl-feat` command with the Flexible GTT Load Sharing feature part number. Enter this command.

```
rtrv-ctrl-feat:partnum=893015401
```

The following is an example of the possible output.

```
rlghncxa03w 06-10-28 21:15:37 GMT EAGLE5 36.0.0
The following features have been permanently enabled:
```

Feature Name	Partnum	Status	Quantity
Flexible GTT Load Sharing	893015401	on	----

The following features have been temporarily enabled:

Feature Name	Partnum	Status	Quantity	Trial
Period Left				
Zero entries found.				

The following features have expired temporary keys:

Feature Name	Partnum
Zero entries found.	

- Back up the new changes using the `chg-db:action=backup:dest=fixed` command. These messages should appear, the active Maintenance and Administration Subsystem Processor (MASP) appears first.

```
BACKUP (FIXED) : MASP A - Backup starts on active MASP.
BACKUP (FIXED) : MASP A - Backup on active MASP to fixed disk
complete.
BACKUP (FIXED) : MASP A - Backup starts on standby MASP.
BACKUP (FIXED) : MASP A - Backup on standby MASP to fixed disk
complete.
```

Figure 5-17 Activate the Flexible GTT Load Sharing Feature - Sheet 1 of 4

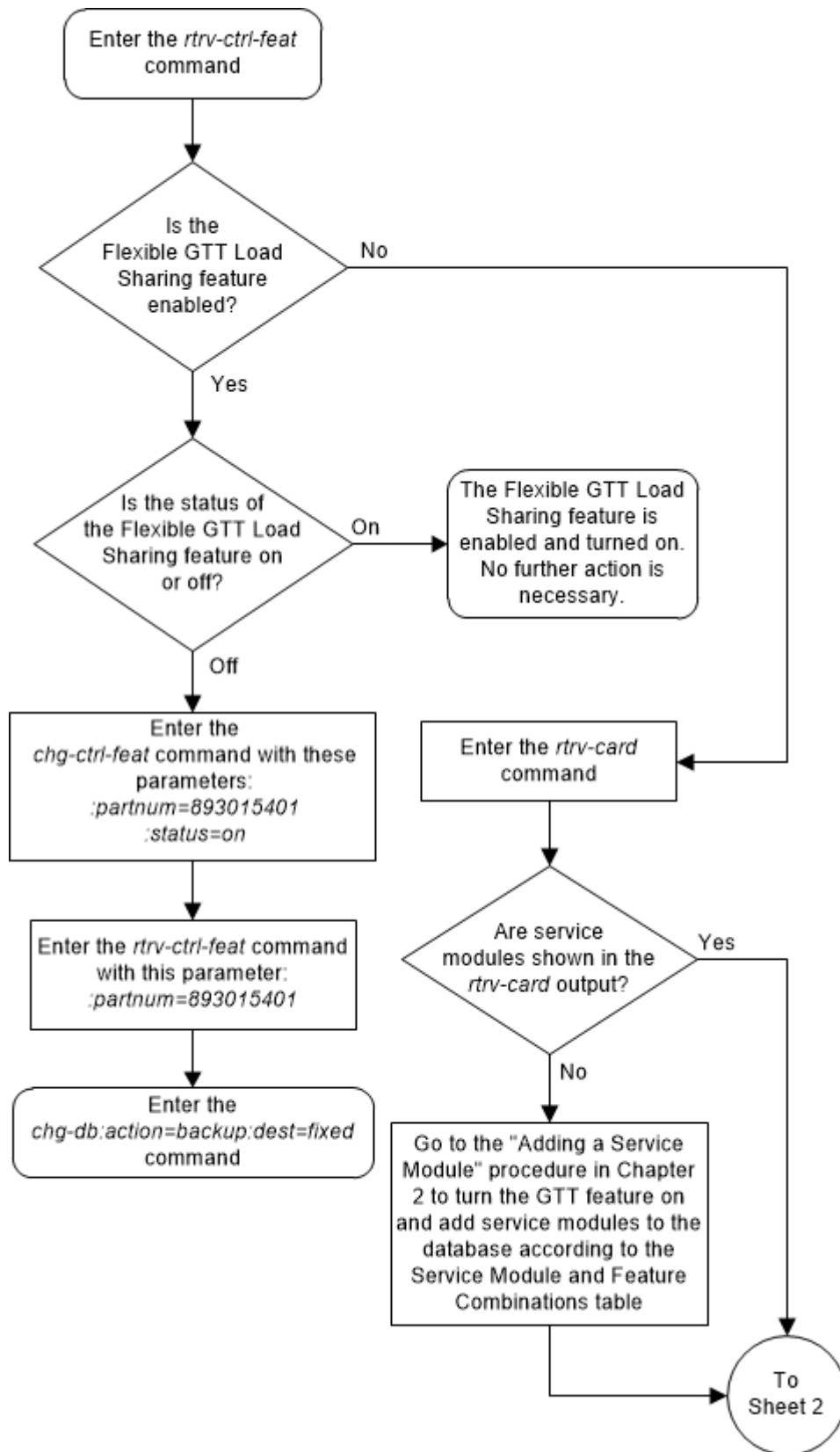

Figure 5-18 Activate the Flexible GTT Load Sharing Feature - Sheet 2 of 4

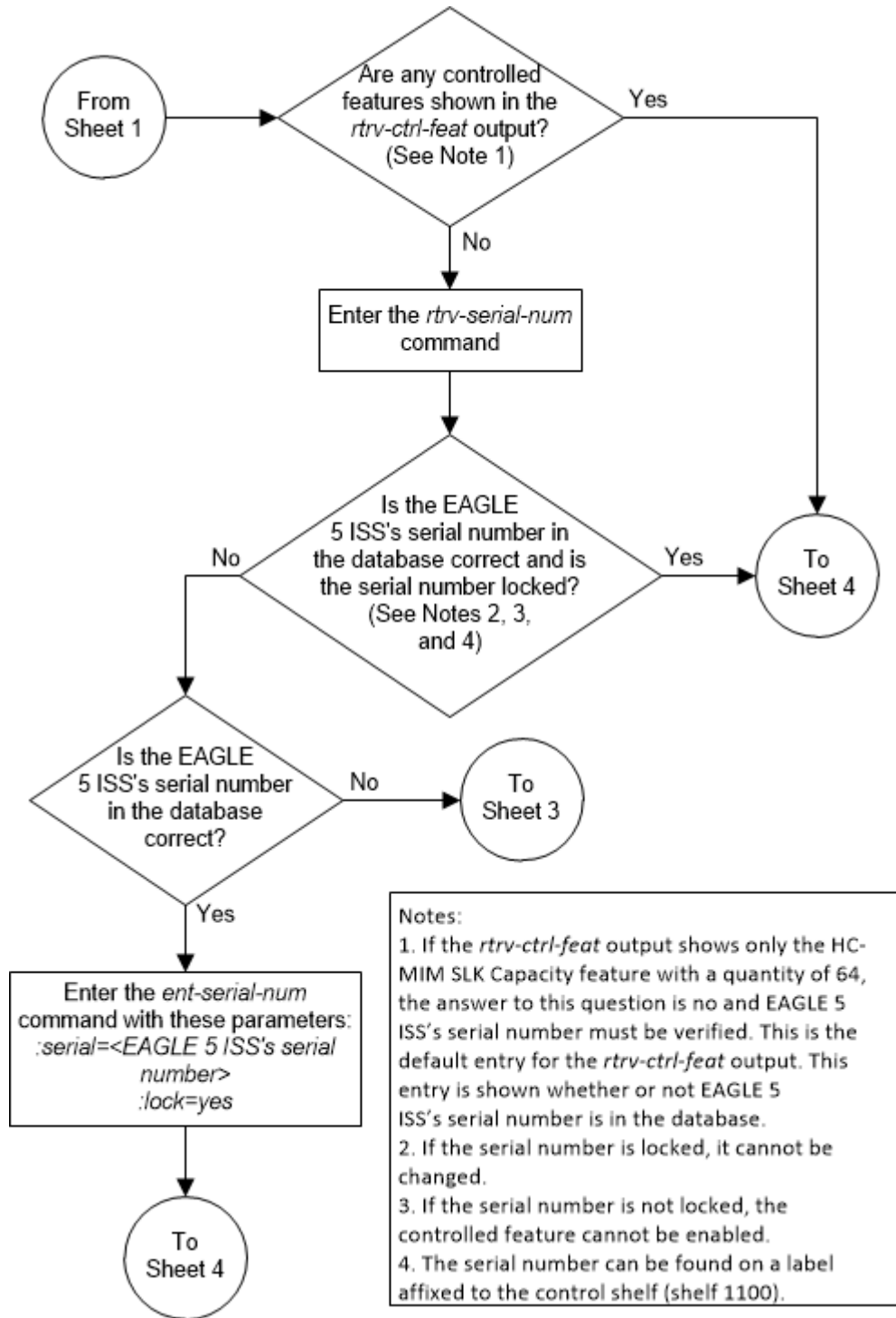

Figure 5-19 Activate the Flexible GTT Load Sharing Feature - Sheet 3 of 4

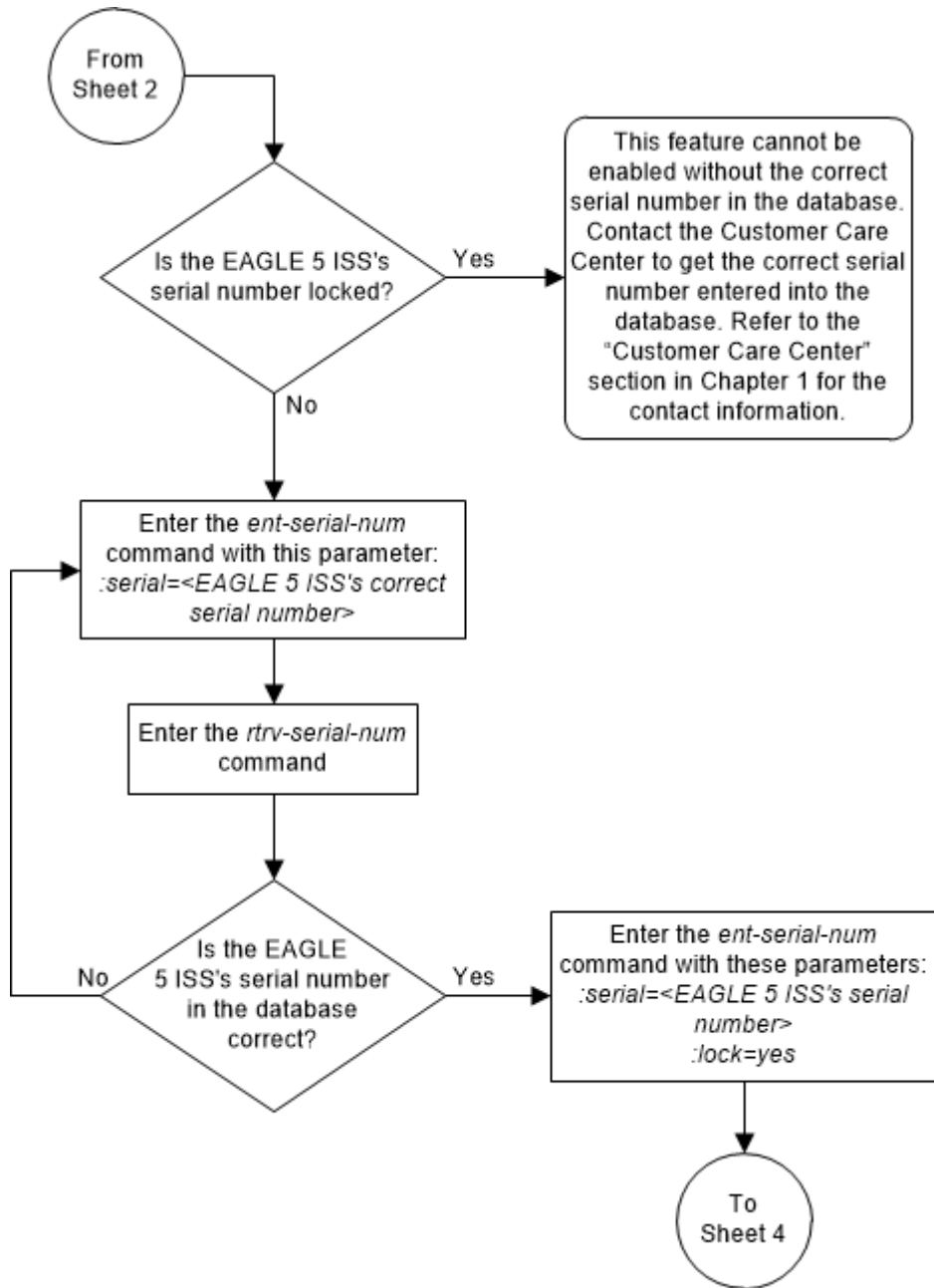
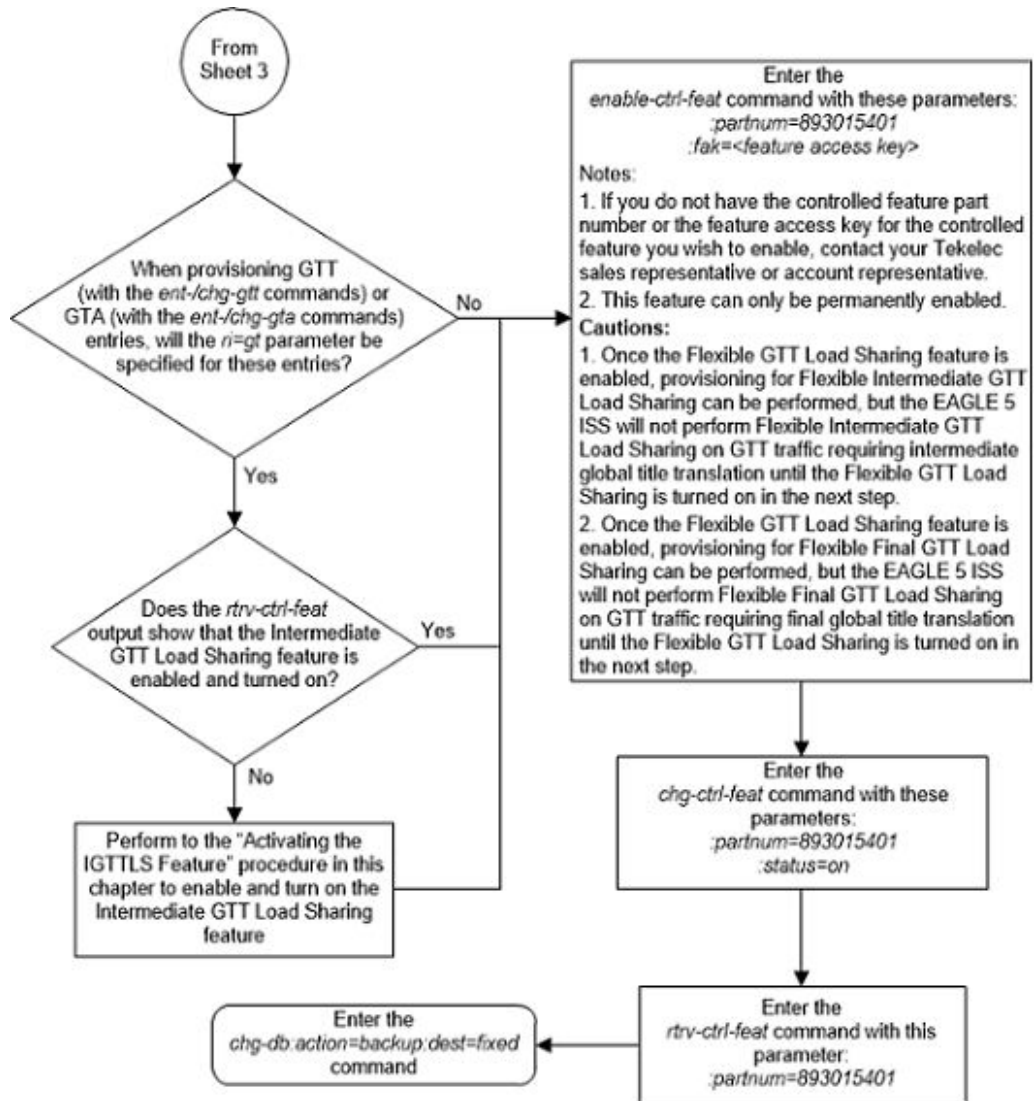

Figure 5-20 Activate the Flexible GTT Load Sharing Feature - Sheet 4 of 4



Turning Off the Flexible GTT Load Sharing Feature

This procedure is used to turn off the Flexible GTT Load Sharing feature, using the `chg-ctrl-feat` command.

The `chg-ctrl-feat` command uses the following parameters:

- :partnum - The part number of the Flexible GTT Load Sharing feature, 893015401.
- :status=off – used to turn off the Flexible GTT Load Sharing feature.

The status of the Flexible GTT Load Sharing controlled feature must be `on` and is shown with the `rtrv-ctrl-feat` command.

▲ Caution:

If the Prepaid SMS Intercept Phase 1 feature is turned off, the screening of incoming messages from an MSC by the EAGLE will not be performed.

▲ Caution:

If the Flexible GTT Load Sharing feature is turned off, provisioning for Flexible Final GTT Load Sharing can be performed with the `ent-map`, `dlt-map`, `chg-map`, and `rtrv-map` commands. The EAGLE will not perform Flexible Final GTT Load Sharing on GTT traffic requiring final global title translation.

1. Display the status of the Flexible GTT Load Sharing feature by entering the `rtrv-ctrl-feat:partnum=893015401` command.

The following is an example of the possible output.

```
rlghncxa03w 06-10-28 21:15:37 GMT EAGLE5 36.0.0
The following features have been permanently enabled:
```

Feature Name	Partnum	Status	Quantity
Flexible GTT Load Sharing	893015401	on	----

The following features have been temporarily enabled:

Feature Name	Partnum	Status	Quantity	Trial
Period Left				
Zero entries found.				

The following features have expired temporary keys:

Feature Name	Partnum
Zero entries found.	

If the status of the Flexible GTT Load Sharing feature is off, or if the Flexible GTT Load Sharing feature is not enabled, this procedure cannot be performed.

2. Turn off the Flexible GTT Load Sharing feature by entering the `chg-ctrl-feat` command with the `status=off` parameter.

For example, enter this command.

```
chg-ctrl-feat:partnum=893015401:status=off
```

When this command has successfully completed, the following message should appear.

```
rlghncxa03w 06-10-28 21:16:37 GMT EAGLE5 36.0.0
CHG-CTRL-FEAT: MASP A - COMPLTD
```

3. Verify that the Flexible GTT Load Sharing feature has been turned off by using the `rtrv-ctrl-feat:partnum=893015401` command. The following is an example of the possible output.

```
rlghncxa03w 06-10-28 21:15:37 GMT EAGLE5 36.0.0  
The following features have been permanently enabled:
```

Feature Name	Partnum	Status	Quantity
Flexible GTT Load Sharing	893015401	off	----

The following features have been temporarily enabled:

Feature Name	Partnum	Status	Quantity	Trial Period Left
Zero entries found.				

The following features have expired temporary keys:

Feature Name	Partnum
Zero entries found.	

4. Backup the new changes using the `chg-db:action=backup:dest=fixed` command.

These messages should appear, the active Maintenance and Administration Subsystem Processor (MASP) appears first.

```
BACKUP (FIXED) : MASP A - Backup starts on active MASP.  
BACKUP (FIXED) : MASP A - Backup on active MASP to fixed disk  
complete.  
BACKUP (FIXED) : MASP A - Backup starts on standby MASP.  
BACKUP (FIXED) : MASP A - Backup on standby MASP to fixed disk  
complete.
```

Figure 5-21 Turn Off the Flexible GTT Load Sharing Feature

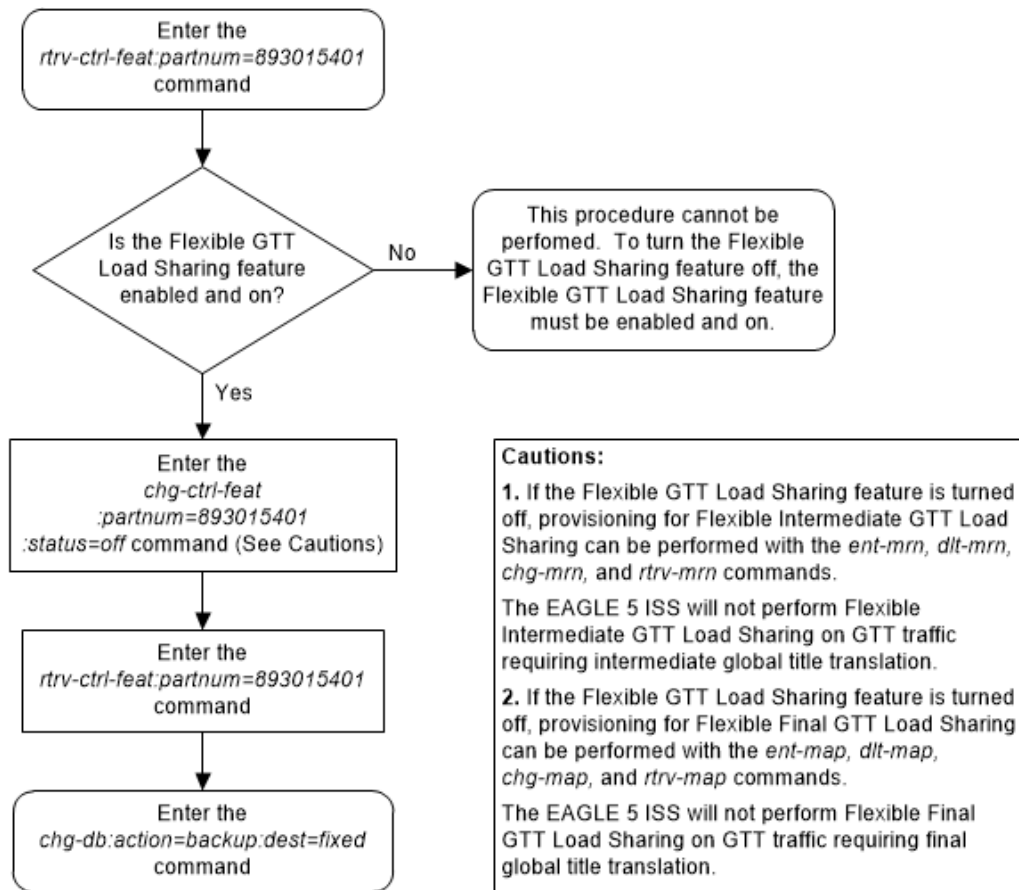

Activating the Origin-Based SSCP Routing Feature

This procedure is used to enable and turn on the Origin-Based SSCP Routing feature using the feature's part number and a feature access key.

The feature access key for the Origin-Based SSCP Routing feature is based on the feature's part number and the serial number of the EAGLE, making the feature access key site-specific.

The *enable-ctrl-feat* command enables the feature by inputting the feature's access key and the feature's part number with these parameters:

:fak – The feature access key generated by the feature access key generator. The feature access key contains 13 alphanumeric characters and is not case sensitive.

:partnum – The issued part number of the Origin-Based SSCP Routing feature, 893014301.

The *enable-ctrl-feat* command requires that the database contain a valid serial number for the EAGLE, and that this serial number is locked. This can be verified with the *rtrv-serial-num* command. The EAGLE is shipped with a serial number in the database, but the serial number is not locked. The serial number can be changed,

if necessary, and locked once the EAGLE is on-site, with the `ent-serial-num` command. The `ent-serial-num` command uses these parameters.

`:serial` – The serial number assigned to the EAGLE. The serial number is not case sensitive.

`:lock` – Specifies whether or not the serial number is locked. This parameter has only one value, `yes`, which locks the serial number. Once the serial number is locked, it cannot be changed.

 **Note:**

To enter and lock the EAGLE's serial number, the `ent-serial-num` command must be entered twice, once to add the correct serial number to the database with the `serial` parameter, then again with the `serial` and the `lock=yes` parameters to lock the serial number. You should verify that the serial number in the database is correct before locking the serial number. The serial number can be found on a label affixed to the control shelf (shelf 1100).

This feature cannot be temporarily enabled (with the temporary feature access key).

Once this feature is enabled, provisioning for this feature can be performed, but the feature will not work until the feature is turned on with the `chg-ctrl-feat` command.

Once this feature has been enabled, the feature must be turned on with the `chg-ctrl-feat` command. The `chg-ctrl-feat` command uses these parameters:

`:partnum` – The issued part number of the Origin-Based SCCP Routing feature, 893014301.

`:status=on` – used to turn the Origin-Based SCCP Routing feature on.

Once the Origin-Based SCCP Routing feature has been turned on, it cannot be turned off.

The status of the features in the EAGLE is shown with the `rtrv-ctrl-feat` command.

The Origin-Based SCCP Routing feature requires that SMs or E5-SM4G cards are installed and provisioned in the EAGLE. SMs and E5-SM4G cards are shown by the entries `SM` in the `TYPE` column and `VSCCP` in the `APPL` column of the `rtrv-card` output.

Before the Origin-Based SCCP Routing feature can be enabled, the EGTT feature must be turned on. The state of the EGTT feature can be verified using the `rtrv-feat` command.

1. Display the status of the Origin-Based SCCP Routing feature by entering the `rtrv-ctrl-feat` command. The following is an example of the possible output.

```
rlghncxa03w 06-10-28 21:15:37 GMT EAGLE5 36.0.0
The following features have been permanently enabled:
```

Feature Name	Partnum	Status	Quantity
Command Class Management	893005801	on	----

```
LNP Short Message Service 893006601 on ----
Intermed GTT Load Sharing 893006901 on ----
HC-MIM SLK Capacity 893012707 on 64
```

The following features have been temporarily enabled:

Feature Name	Partnum	Status	Quantity	Trial
Period Left				
Zero entries found.				

The following features have expired temporary keys:

Feature Name	Partnum
Zero entries found.	

If the Origin-Based SCCP Routing feature is enabled and turned on, no further action is necessary. This procedure does not need to be performed.

If the Origin-Based SCCP Routing feature is enabled and but not turned on, skip steps 2 through 9 and go to step 10.

If the Origin-Based SCCP Routing feature is not enabled, go to step 2.

2. Verify that the EGTT feature is on, by entering the `rtrv-feat` command. If the EGTT feature is on, the `EGTT` field should be set to `on`.

 **Note:**

The `rtrv-feat` command output contains other fields that are not used by this procedure. If you wish to see all the fields displayed by the `rtrv-feat` command, see the `rtrv-feat` command description in *Commands User's Guide*.

 **Note:**

If the EGTT feature is on, shown by the entry `EGTT = on` in the `rtrv-feat` command output in step 2, skip step 3 and go to step 4.

3. Turn the enhanced global title translation feature on by entering this command.

```
chg-feat:egtt=on
```

If the GTT feature is not on, turn the GTT feature on by specifying the `gtt=on` parameter with the `egtt=on` parameter.

 **Note:**

Once the Enhanced Global Title Translation (EGTT) feature is turned on with the `chg-feat` command, it cannot be turned off. The EGTT feature must be purchased before turning it on. If you are not sure whether you have purchased the EGTT feature, contact your Sales Representative or Account Representative.

When the `chg-feat` has successfully completed, this message should appear.

```
rlghncxa03w 06-10-25 09:57:41 GMT EAGLE5 36.0.0
CHG-FEAT: MASP A - COMPLTD
```

4. Display the cards in the EAGLE 5 using the `rtrv-card` command. The Origin-Based SCCP Routing feature requires that SMs or E5-SM4G cards running the VSCCP application are in the database. This is an example of the possible output.

```
rlghncxa03w 13-05-25 09:58:31 GMT EAGLE5 45.0.0
CARD   TYPE      APPL      LSET NAME      PORT SLC LSET NAME
PORT SLC
1102   TSM          GLS
1113   E5MCAP      OAMHC
1114   E5TDM-A
1115   E5MCAP      OAMHC
1116   E5TDM-B
1117   E5MDAL
1201   LIMDS0      SS7ANSI   sp2            A    0    sp1
B      0
1203   LIMDS0      SS7ANSI   sp3            A    0
1204   LIMDS0      SS7ANSI   sp3            A    1
1206   LIMDS0      SS7ANSI   nsp3           A    1    nsp4
B      1
1301   DSM          VSCCP
1303   DSM          VSCCP
1305   DSM          VSCCP
1308   LIMDS0      SS7ANSI   sp6            A    1    sp7
B      0
1314   LIMDS0      SS7ANSI   sp7            A    1    sp5
B      1
```

There are two types of service modules, SMs or E5-SM4G cards running the VSCCP application.

SMs and E5-SM4G cards are shown by the entries `SM` in the `TYPE` column and `VSCCP` in the `APPL` column.

If no service modules are shown in the `rtrv-card` output, perform [Adding a Service Module](#) to add SMs or E5-SM4G cards to the EAGLE.

If DSMs or E5-SM4G cards running the VSCCP application are in the EAGLE, go to step 5.

 **Note:**

If the `rtrv-ctrl-feat` output in step 1 shows any controlled features, skip steps 5 through 8, and go to step 9. If the `rtrv-ctrl-feat` output shows only the HC-MIM SLK Capacity feature with a quantity of 64, steps 5 through 8 must be performed.

5. Display the serial number in the database with the `rtrv-serial-num` command. This is an example of the possible output.

```
rlghncxa03w 06-10-28 21:15:37 GMT EAGLE5 36.0.0
System serial number = nt00001231
```

System serial number is not locked.

```
rlghncxa03w 06-10-28 21:15:37 GMT EAGLE5 36.0.0
Command Completed.
```

 **Note:**

If the serial number is correct and locked, skip steps 6, 7, and 8, and go to step 9. If the serial number is correct but not locked, skip steps 5 and 7, and go to step 8. If the serial number is not correct, but is locked, this feature cannot be enabled and the remainder of this procedure cannot be performed. Contact the Customer Care Center to get an incorrect and locked serial number changed. Refer to [#unique_17](#) for the contact information. The serial number can be found on a label affixed to the control shelf (shelf 1100).

6. Enter the correct serial number into the database using the `ent-serial-num` command with the `serial` parameter.

For this example, enter this command.

```
ent-serial-num:serial=<EAGLE's correct serial number>
```

When this command has successfully completed, the following message should appear.

```
rlghncxa03w 06-10-28 21:15:37 GMT EAGLE5 36.0.0
ENT-SERIAL-NUM: MASP A - COMPLTD
```

7. Verify that the serial number entered into step 6 was entered correctly using the `rtrv-serial-num` command. This is an example of the possible output.

```
rlghncxa03w 06-10-28 21:15:37 GMT EAGLE5 36.0.0
System serial number = nt00001231
```

System serial number is not locked.

```
rlghncxa03w 06-10-28 21:15:37 GMT EAGLE5 36.0.0
Command Completed.
```

If the serial number was not entered correctly, repeat steps 6 and 7 and re-enter the correct serial number.

8. Lock the serial number in the database by entering the `ent-serial-num` command with the serial number shown in step 5, if the serial number shown in step 5 is correct, or with the serial number shown in step 7, if the serial number was changed in step 6, and with the `lock=yes` parameter.

For this example, enter this command.

```
ent-serial-num:serial=<EAGLE's serial number>:lock=yes
```

When this command has successfully completed, the following message should appear.

```
rlghncxa03w 06-10-28 21:15:37 GMT EAGLE5 36.0.0  
ENT-SERIAL-NUM: MASP A - COMPLTD
```

9. Enable the Origin-Based SCCP Routing feature with the `enable-ctrl-feat` command specifying the part number for the Origin-Based SCCP Routing feature and the feature access key. Enter this command.

```
enable-ctrl-feat:partnum=893014301:fak=<Origin-Based SCCP  
Routing feature access key>
```

 **Note:**

The Origin-Based SCCP Routing feature cannot be enabled with a temporary feature access key.

 **Note:**

The values for the feature access key (the `fak` parameter) are provided. If you do not have the feature access key for the Origin-Based SCCP Routing feature, contact your Sales Representative or Account Representative.

When the `enable-ctrl-feat` command has successfully completed, this message should appear.

```
rlghncxa03w 06-10-28 21:15:37 GMT EAGLE5 36.0.0  
ENABLE-CTRL-FEAT: MASP B - COMPLTD
```

 **Caution:**

Once the Origin-Based SCCP Routing feature is enabled, provisioning for Origin-Based SCCP Routing can be performed except for provisioning the Origin-Based SCCP Routing GTT mode hierarchy for linksets and system wide default GTT mode option with one of the Origin-Based SCCP Routing GTT mode hierarchies. The Origin-Based SCCP Routing GTT mode hierarchy for linksets and system wide default GTT mode option with one of the Origin-Based SCCP Routing GTT mode hierarchies can be provisioned only when the Origin-Based SCCP Routing feature is enabled and turned on. The EAGLE will not perform Origin-Based SCCP Routing on GTT traffic until the Origin-Based SCCP Routing is turned on in step 10.

10. Turn the Origin-Based SCCP Routing feature on with the `chg-ctrl-feat` command specifying the part number for the Origin-Based SCCP Routing feature and the `status=on` parameter.

Enter this command.

```
chg-ctrl-feat:partnum=893014301:status=on
```

When the `chg-ctrl-feat` command has successfully completed, this message should appear.

```
rlghncxa03w 06-10-28 21:15:37 GMT EAGLE5 36.0.0  
CHG-CTRL-FEAT: MASP B - COMPLTD
```

11. Verify the changes by entering the `rtrv-ctrl-feat` command with the Origin-Based SCCP Routing feature part number. Enter this command.

```
rtrv-ctrl-feat:partnum=893014301
```

The following is an example of the possible output.

```
rlghncxa03w 06-10-28 21:15:37 GMT EAGLE5 36.0.0  
The following features have been permanently enabled:
```

Feature Name	Partnum	Status	Quantity
Origin Based SCCP Routing	893014301	on	----

The following features have been temporarily enabled:

Feature Name	Partnum	Status	Quantity	Trial Period Left
Zero entries found.				

The following features have expired temporary keys:

Feature Name	Partnum
Zero entries found.	

12. Backup the new changes using the `chg-db:action=backup:dest=fixed` command. These messages should appear, the active Maintenance and Administration Subsystem Processor (MASP) appears first.

```
BACKUP (FIXED) : MASP A - Backup starts on active MASP.  
BACKUP (FIXED) : MASP A - Backup on active MASP to fixed disk  
complete.  
BACKUP (FIXED) : MASP A - Backup starts on standby MASP.  
BACKUP (FIXED) : MASP A - Backup on standby MASP to fixed disk  
complete.
```

Figure 5-22 Activate the Origin-Based SCCP Routing Feature - Sheet 1 of 5

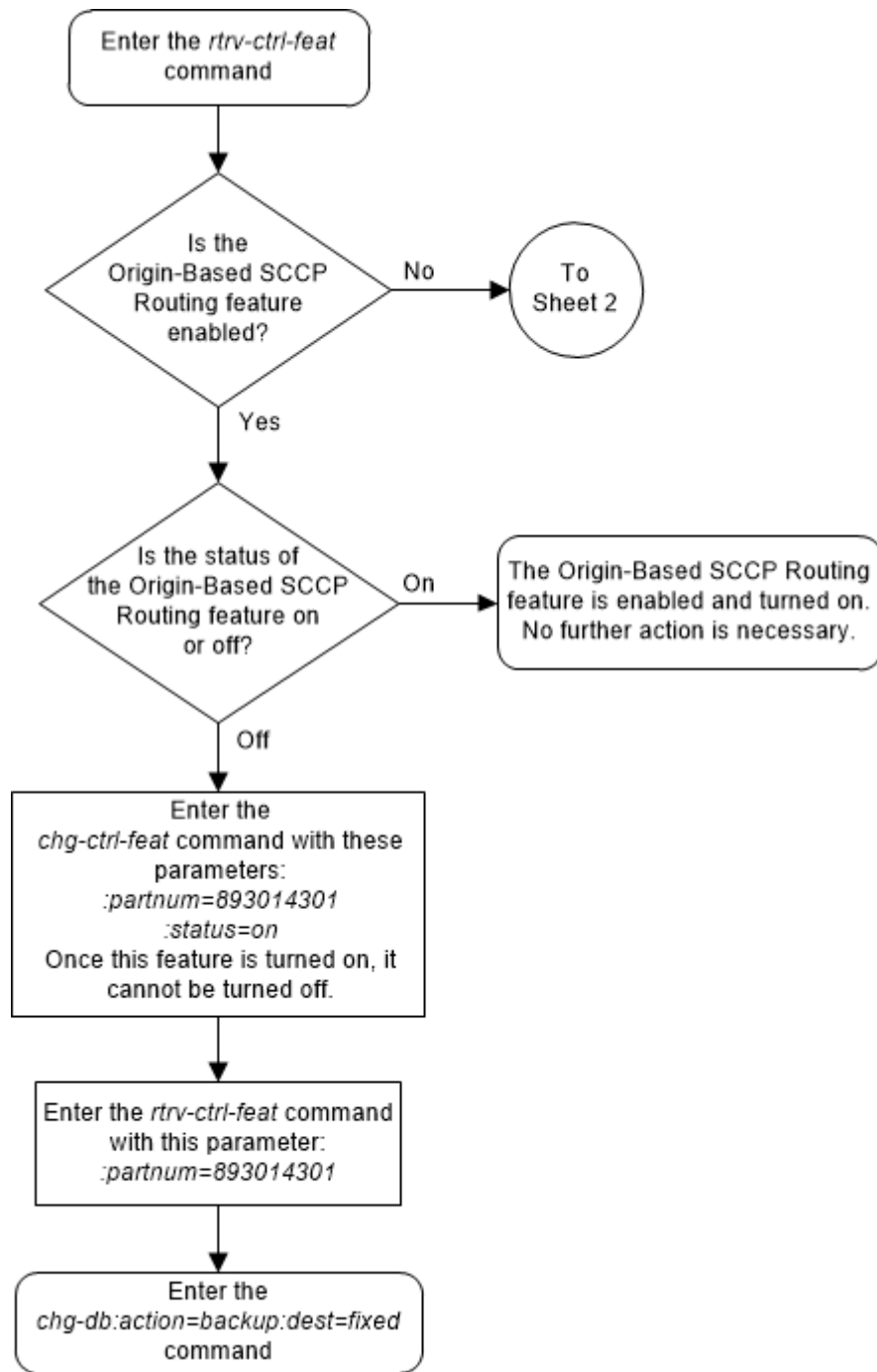

Figure 5-23 Activate the Origin-Based SCCP Routing Feature - Sheet 2 of 5

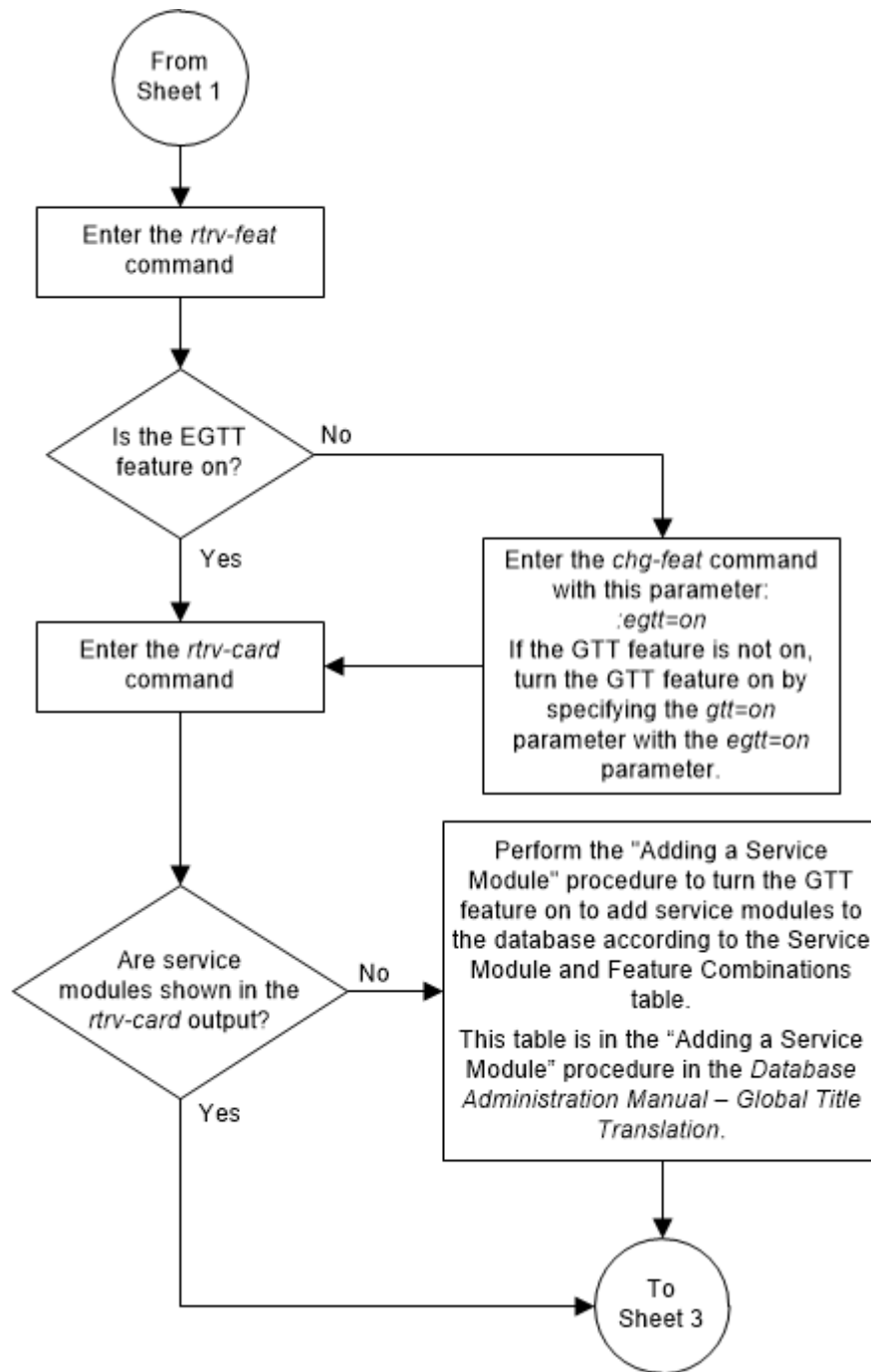

Figure 5-24 Activate the Origin-Based SCCP Routing Feature - Sheet 3 of 5

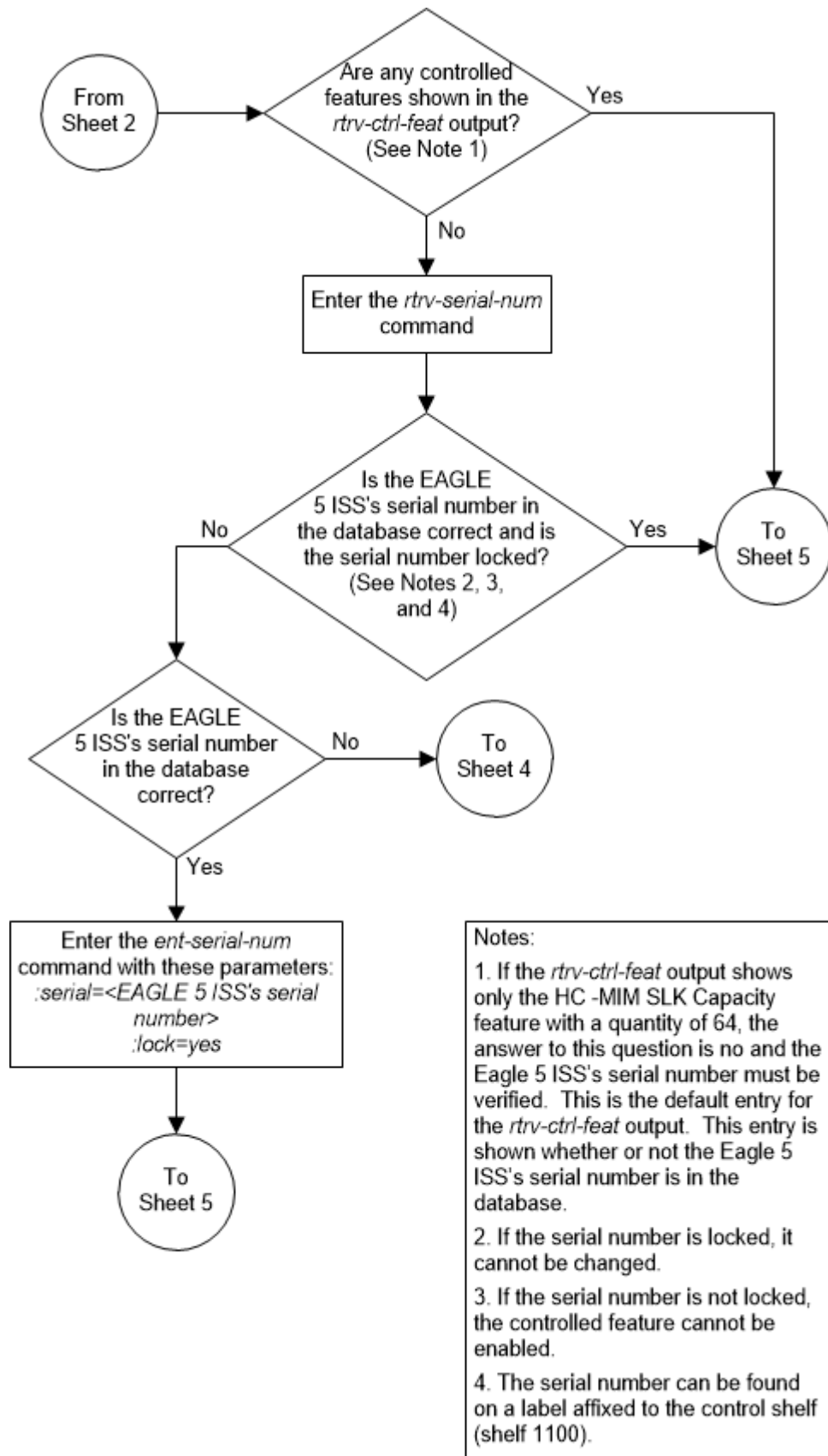

Figure 5-25 Activate the Origin-Based SCCP Routing Feature - Sheet 4 of 5

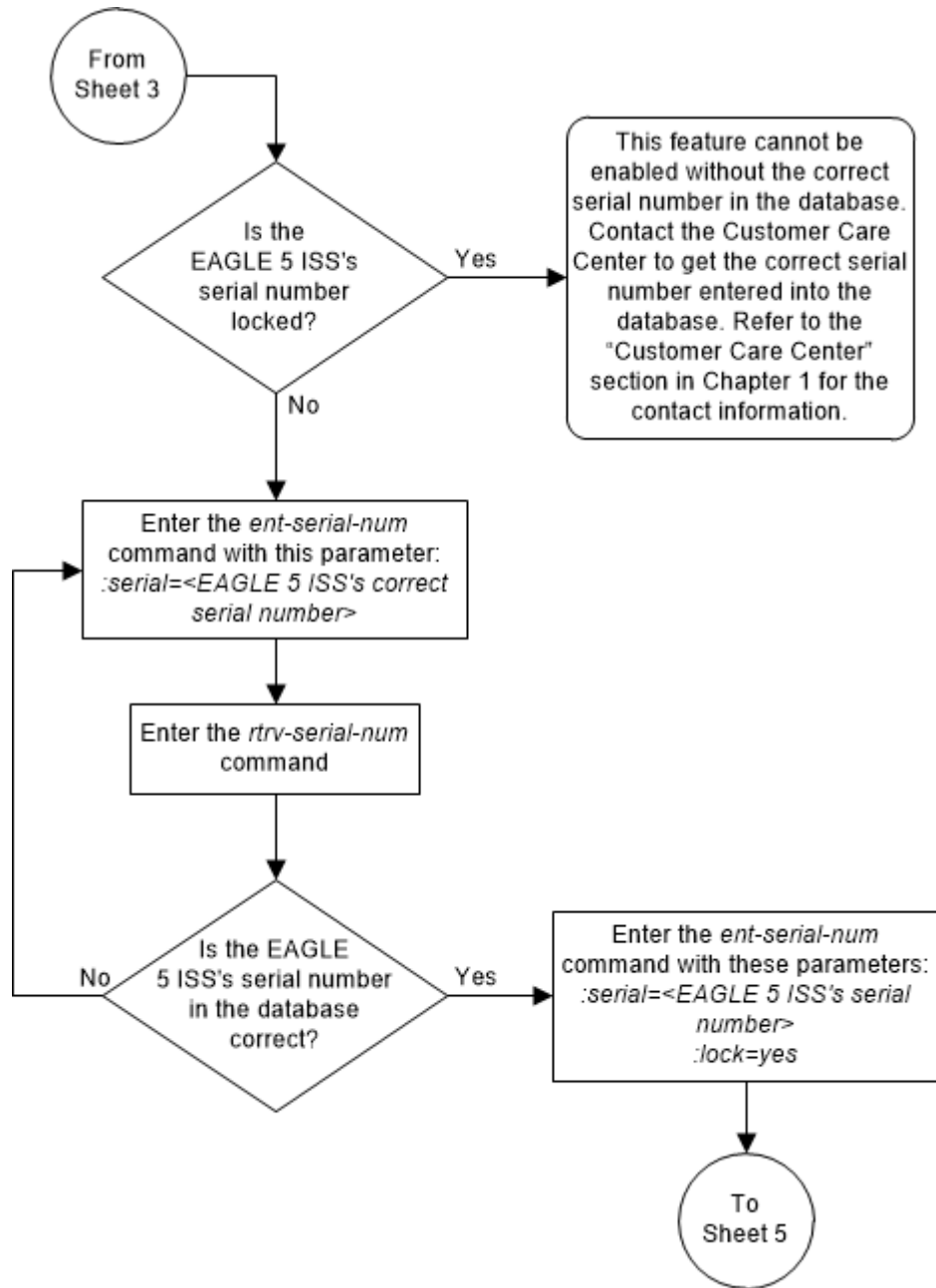
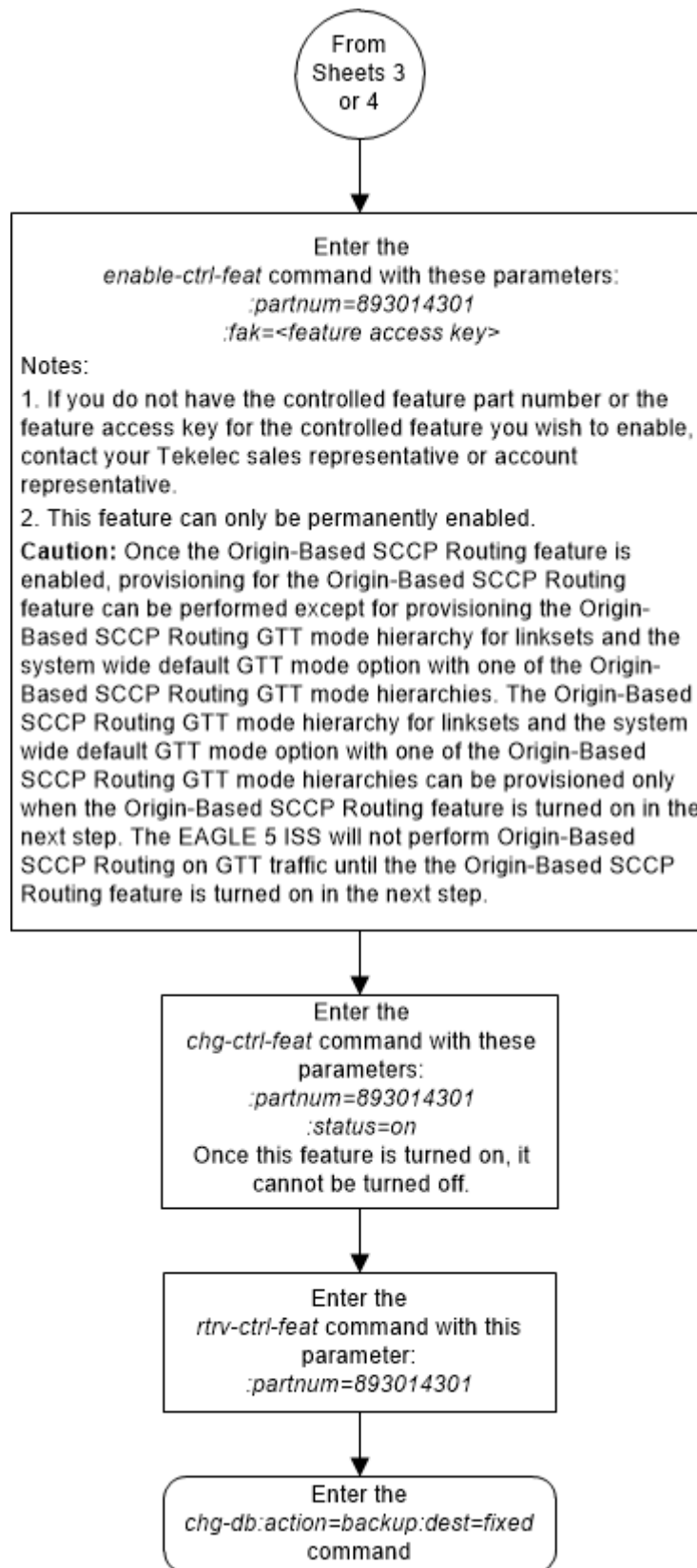

Figure 5-26 Activate the Origin-Based SCCP Routing Feature - Sheet 5 of 5



Activating the Hex Digit Support for GTT Feature

This procedure is used to enable and turn on the Hex Digit Support for GTT feature using the feature's part number.

The feature access key for the Hex Digit Support for GTT feature is based on the feature's part number and the serial number of the EAGLE, making the feature access key site-specific.

The `enable-ctrl-feat` command enables the feature by inputting the feature's access key and the feature's part number with these parameters:

`:fak` – The feature access key provided. The feature access key contains 13 alphanumeric characters and is not case sensitive.

`:partnum` – The issued part number of the Hex Digit Support for GTT feature, 893018501.

The `enable-ctrl-feat` command requires that the database contain a valid serial number for the EAGLE, and that this serial number is locked. This can be verified with the `rtrv-serial-num` command. The EAGLE is shipped with a serial number in the database, but the serial number is not locked. The serial number can be changed, if necessary, and locked once the EAGLE is on-site, with the `ent-serial-num` command. The `ent-serial-num` command uses these parameters.

`:serial` – The serial number assigned to the EAGLE. The serial number is not case sensitive.

`:lock` – Specifies whether or not the serial number is locked. This parameter has only one value, `yes`, which locks the serial number. Once the serial number is locked, it cannot be changed.

Note:

To enter and lock the EAGLE's serial number, the `ent-serial-num` command must be entered twice, once to add the correct serial number to the database with the `serial` parameter, then again with the `serial` and the `lock=yes` parameters to lock the serial number. You should verify that the serial number in the database is correct before locking the serial number. The serial number can be found on a label affixed to the control shelf (shelf 1100).

This feature cannot be temporarily enabled (with the temporary feature access key).

Once this feature is enabled, the feature is also activated. The `chg-ctrl-feat` command cannot be used to turn this feature on. Once this feature is enabled, the feature cannot be turned off.

The status of the feature in the EAGLE is shown with the `rtrv-ctrl-feat` command.

The Hex Digit Support for GTT feature requires that DSMs or SLIC cards are installed and provisioned in the EAGLE. DSM cards are shown by the entry `dsm` in the `TYPE` column and `vsccp` in the `APPL` column of the `rtrv-card` output. SLIC cards are

shown as `type=dsm` (in the odd numbered card slots) or `type=slic` (in the even numbered card slots), and `appl=vsccp`.

Before the Hex Digit Support for GTT feature can be enabled, the GTT feature must be turned on. The state of the GTT feature can be verified using the `rtrv-feat` command.

1. Display the status of the Hex Digit Support for GTT feature by entering the `rtrv-ctrl-feat` command.

The following is an example of the possible output.

```
rlghncxa03w 06-10-28 21:15:37 GMT EAGLE5 36.0.0
The following features have been permanently enabled:
```

Feature Name	Partnum	Status	Quantity
Command Class Management	893005801	on	----
LNP Short Message Service	893006601	on	----
Intermed GTT Load Sharing	893006901	on	----
HC-MIM SLK Capacity	893012707	on	64

The following features have been temporarily enabled:

Feature Name	Partnum	Status	Quantity	Trial Period Left
Zero entries found.				

The following features have expired temporary keys:

Feature Name	Partnum
Zero entries found.	

If the Hex Digit Support for GTT feature is enabled, the entry `Hex Digit Support for GTT` is shown in the `rtrv-ctrl-feat` output. No further action is necessary. This procedure does not need to be performed.

If the Hex Digit Support for GTT feature is not enabled, continue the procedure with [2](#).

2. Verify the GTT feature is on, by entering the `rtrv-feat` command. If the GTT feature is on, the `GTT` field should be set to `on`.

 **Note:**

The `rtrv-feat` command output contains other fields that are not used by this procedure. If you wish to see all the fields displayed by the `rtrv-feat` command, see the `rtrv-feat` command description in *Commands User's Guide*.

If the GTT feature is not on, perform [Adding a Service Module](#) to turn the GTT feature on and add SMs or SLIC cards to the EAGLE. After the GTT feature is turned on and the SMs or SLIC have been added, continue the procedure with [4](#).

If the GTT feature is on, continue the procedure with [3](#).

3. Display the cards in the EAGLE using the `rtrv-card` command. The Hex Digit Support for GTT feature requires that DSMs or SLIC running the VSCCP application are in the database. This is an example of the possible output.

```
rlghncxa03w 13-05-25 09:58:31 GMT EAGLE5 45.0.0
CARD   TYPE      APPL      LSET NAME      PORT SLC LSET NAME
PORT SLC
1102   TSM          GLS
1113   E5MCAP      OAMHC
1114   E5TDM-A
1115   E5MCAP      OAMHC
1116   E5TDM-B
1117   E5MDAL
1201   LIMDS0      SS7ANSI   sp2            A    0    sp1
B      0
1203   LIMDS0      SS7ANSI   sp3            A    0
1204   LIMDS0      SS7ANSI   sp3            A    1
1206   LIMDS0      SS7ANSI   nsp3           A    1    nsp4
B      1
1308   LIMDS0      SS7ANSI   sp6            A    1    sp7
B      0
1314   LIMDS0      SS7ANSI   sp7            A    1    sp5
B      1
```

SMs and SLIC cards run the VSCCP application.

SM cards are shown by the entry `dsm` in the `TYPE` column and `vscpp` in the `APPL` column of the `rtrv-card` output. SLIC cards are shown as `type=dsm` (in the odd numbered card slots) or `type=slic` (in the even numbered card slots), and `appl=vscpp`.

If no service modules are shown in the `rtrv-card` output, perform [Adding a Service Module](#) to add SMs to the EAGLE. After the SMs or SLIC have been added, continue the procedure with 4.

If SMs or SLICs running the VSCCP application are in the EAGLE, continue the procedure with 4.

4. Display the serial number in the database with the `rtrv-serial-num` command.

 **Note:**

If the `rtrv-ctrl-feat` output in 1 shows any controlled features, continue the procedure with 8. If the `rtrv-ctrl-feat` output shows only the HC-MIM SLK Capacity feature with a quantity of 64, 4 through 7 must be performed.

This is an example of the possible output.

```
rlghncxa03w 06-10-28 21:15:37 GMT EAGLE5 36.0.0
System serial number = nt00001231
```

System serial number is not locked.

```
rlghncxa03w 06-10-28 21:15:37 GMT EAGLE5 36.0.0
Command Completed.
```

5. Enter the correct serial number into the database using the `ent-serial-num` command with the `serial` parameter.

 **Note:**

If the serial number is correct and locked, continue the procedure with 8. If the serial number is correct but not locked, continue the procedure with 7. If the serial number is not correct, but is locked, this feature cannot be enabled and the remainder of this procedure cannot be performed. Contact My Oracle Support to get an incorrect and locked serial number changed. Refer to [#unique_17](#) for the contact information. The serial number can be found on a label affixed to the control shelf (shelf 1100).

For this example, enter this command.

```
ent-serial-num:serial=<EAGLE's correct serial number>
```

When this command has successfully completed, the following message should appear.

```
rlghncxa03w 06-10-28 21:15:37 GMT EAGLE5 36.0.0
ENT-SERIAL-NUM: MASP A - COMPLTD
```

6. Verify that the serial number entered in was entered correctly using the `rtrv-serial-num` command.

This is an example of the possible output.

```
rlghncxa03w 06-10-28 21:15:37 GMT EAGLE5 36.0.0
System serial number = nt00001231
```

System serial number is not locked.

```
rlghncxa03w 06-10-28 21:15:37 GMT EAGLE5 36.0.0
Command Completed.
```

If the serial number was not entered correctly, repeat and re-enter the correct serial number.

7. Lock the serial number in the database by entering the `ent-serial-num` command with the serial number shown in , if the serial number shown in is correct, or with the serial number shown in , if the serial number was changed in , and with the `lock=yes` parameter.

For this example, enter this command.

```
ent-serial-num:serial=<EAGLE's serial number>:lock=yes
```

When this command has successfully completed, the following message should appear.

```
rlghncxa03w 06-10-28 21:15:37 GMT EAGLE5 36.0.0
ENT-SERIAL-NUM: MASP A - COMPLTD
```

8. Enable the Hex Digit Support for GTT feature with the `enable-ctrl-feat` command specifying the part number for the Hex Digit Support for GTT feature. Enter this command.

```
enable-ctrl-feat:partnum=893018501
```

 **Note:**

The Hex Digit Support for GTT feature cannot be enabled with a temporary feature access key.

When the `enable-ctrl-feat` command has successfully completed, this message should appear.

```
rlghncxa03w 06-10-28 21:15:37 GMT EAGLE5 36.0.0
ENABLE-CTRL-FEAT: MASP B - COMPLTD
```

9. Verify the changes by entering the `rtrv-ctrl-feat` command with the part number used in .

```
rtrv-ctrl-feat:partnum=893018501
```

The following is an example of the possible output.

```
rlghncxa03w 06-10-28 21:15:37 GMT EAGLE5 36.0.0
The following features have been permanently enabled:
```

Feature Name	Partnum	Status	Quantity
Hex Digit Support for GTT	893018501	on	----

The following features have been temporarily enabled:

Feature Name	Partnum	Status	Quantity	Trial
Period Left				
Zero entries found.				

The following features have expired temporary keys:

Feature Name	Partnum
Zero entries found.	

10. Backup the new changes using the `chg-db:action=backup:dest=fixed` command.

These messages should appear, the active Maintenance and Administration Subsystem Processor (MASP) appears first.

```
BACKUP (FIXED) : MASP A - Backup starts on active MASP.  
BACKUP (FIXED) : MASP A - Backup on active MASP to fixed disk  
complete.  
BACKUP (FIXED) : MASP A - Backup starts on standby MASP.  
BACKUP (FIXED) : MASP A - Backup on standby MASP to fixed disk  
complete.
```

Figure 5-27 Activate the Hex Digit Support for GTT Feature - Sheet 1 of 4

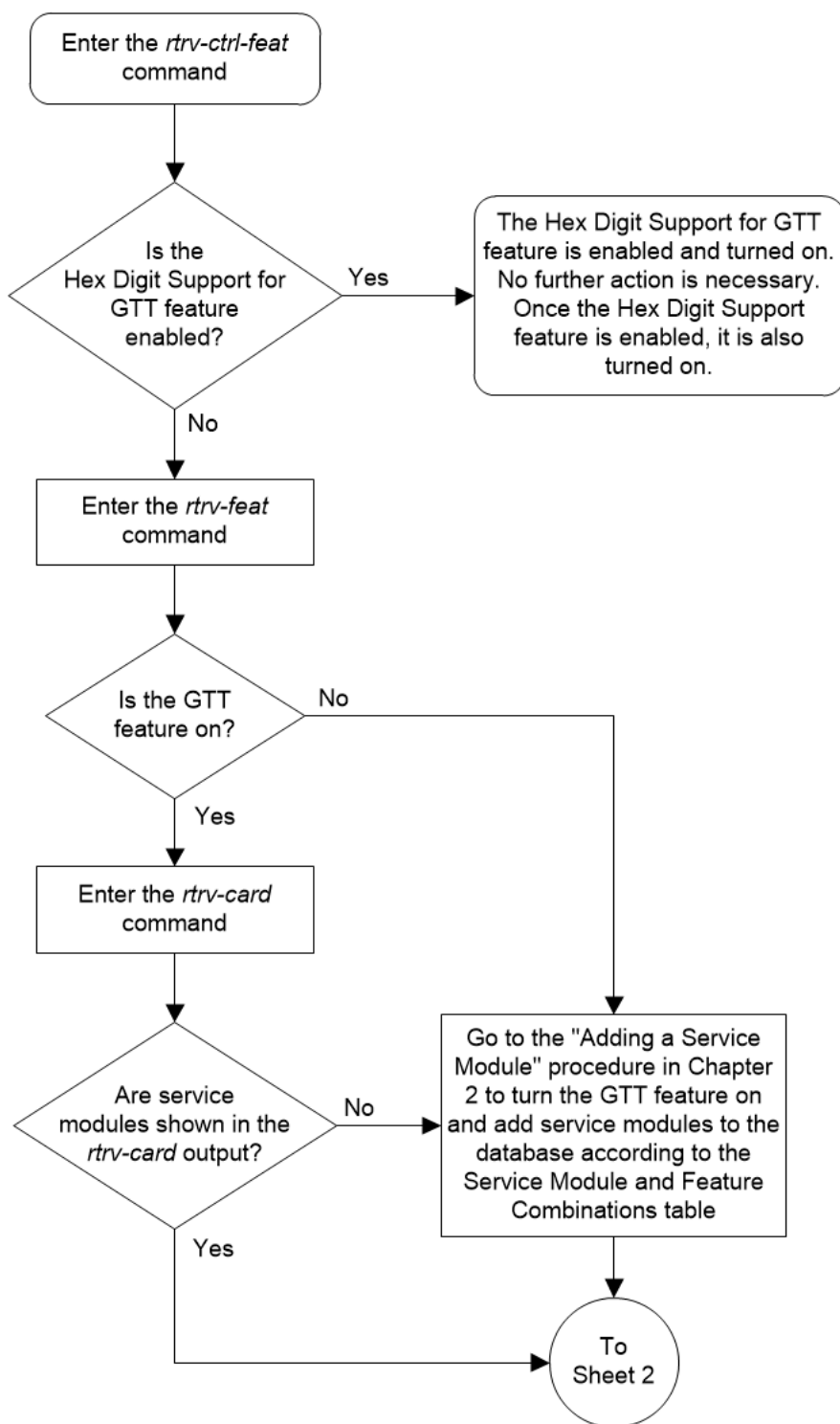

Figure 5-28 Activate the Hex Digit Support for GTT Feature - Sheet 2 of 4

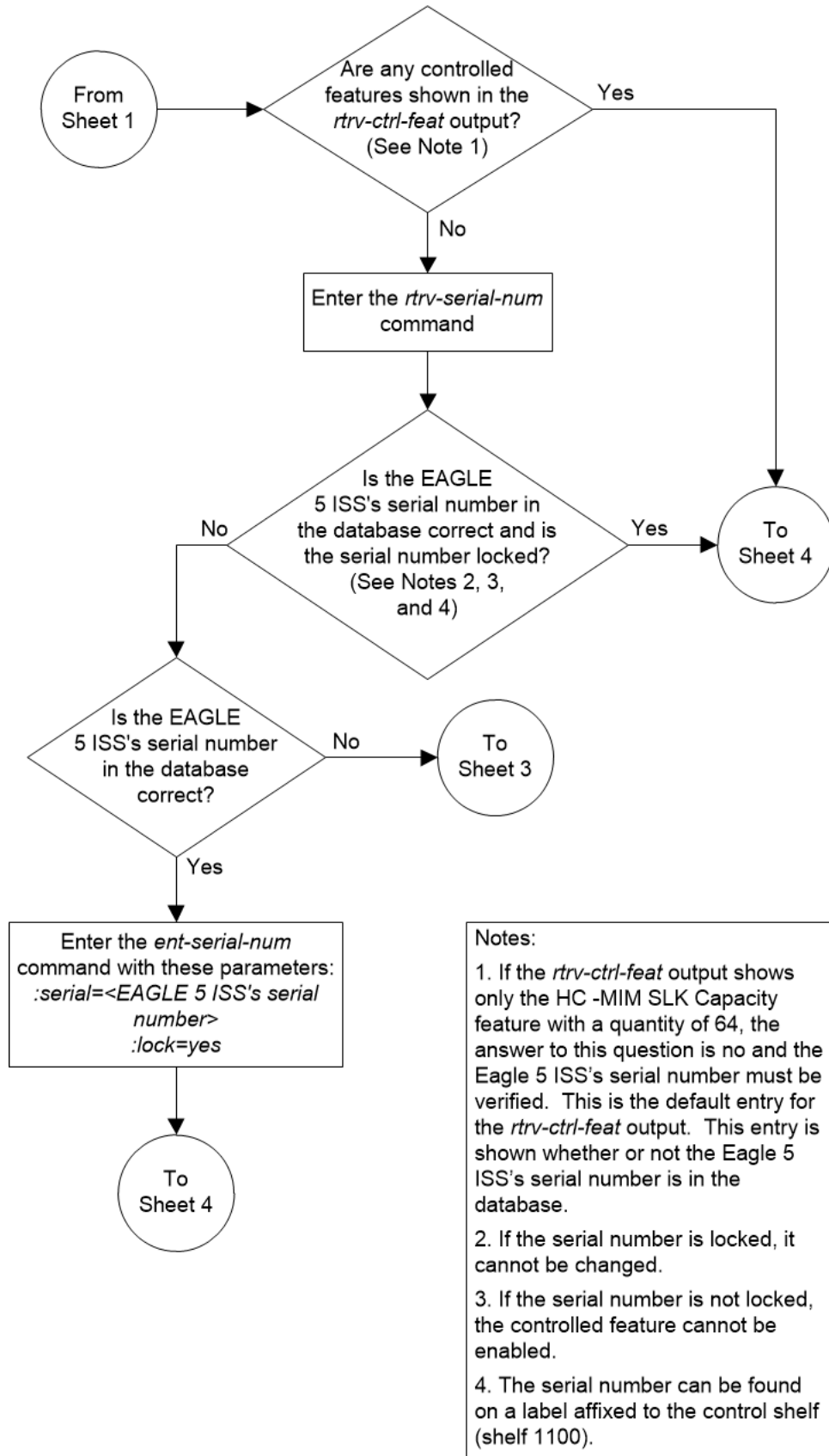

Figure 5-29 Activate the Hex Digit Support for GTT Feature - Sheet 3 of 4

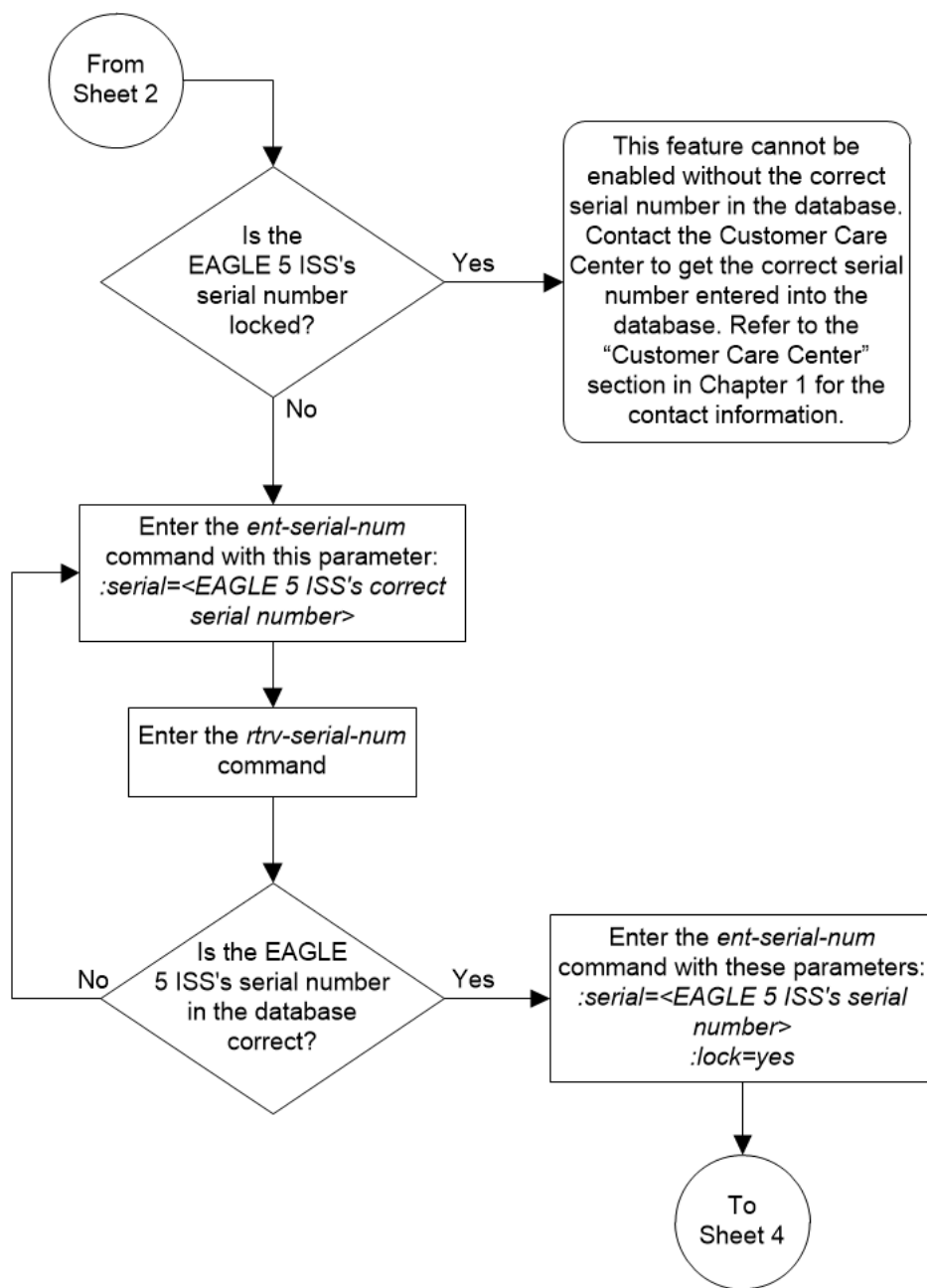
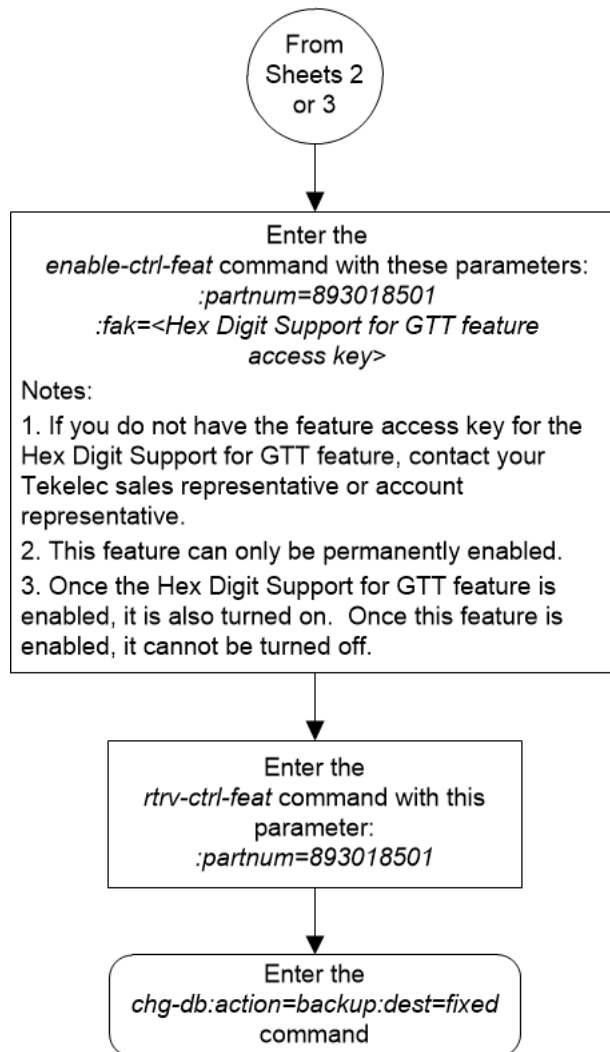

Figure 5-30 Activate the Hex Digit Support for GTT Feature - Sheet 4 of 4



Activating the Weighted GTT Load Sharing Feature

This procedure is used to enable and turn on the Weighted GTT Load Sharing feature using the feature's part number and a feature access key.

The feature access key for the Weighted GTT Load Sharing feature is based on the feature's part number and the serial number of the EAGLE 5, making the feature access key site-specific.

The *enable-ctrl-feat* command enables the feature by inputting the feature's access key and the feature's part number with these parameters:

:fak – The feature access key provided. The feature access key contains 13 alphanumeric characters and is not case sensitive.

:partnum – The issued part number of the Weighted GTT Load Sharing feature, 893017001.

The `enable-ctrl-feat` command requires that the database contain a valid serial number for the EAGLE, and that this serial number is locked. This can be verified with the `rtrv-serial-num` command. The EAGLE is shipped with a serial number in the database, but the serial number is not locked. The serial number can be changed, if necessary, and locked once the EAGLE is on-site, with the `ent-serial-num` command. The `ent-serial-num` command uses these parameters.

`:serial` – The serial number assigned to the EAGLE. The serial number is not case sensitive.

`:lock` – Specifies whether or not the serial number is locked. This parameter has only one value, `yes`, which locks the serial number. Once the serial number is locked, it cannot be changed.

 **Note:**

To enter and lock the EAGLE's serial number, the `ent-serial-num` command must be entered twice, once to add the correct serial number to the database with the `serial` parameter, then again with the `serial` and the `lock=yes` parameters to lock the serial number. You should verify that the serial number in the database is correct before locking the serial number. The serial number can be found on a label affixed to the control shelf (shelf 1100).

This feature cannot be temporarily enabled (with the temporary feature access key).

Once this feature has been enabled, the feature must be turned on with the `chg-ctrl-feat` command. The `chg-ctrl-feat` command uses these parameters:

`:partnum` – The issued part number of the Weighted GTT Load Sharing feature, 893017001.

`:status=on` – used to turn the Weighted GTT Load Sharing feature on.

Once the Weighted GTT Load Sharing feature has been turned on, it cannot be turned off.

The status of the features in the EAGLE is shown with the `rtrv-ctrl-feat` command.

The Weighted GTT Load Sharing feature requires that SMs or E5-SM4G cards are installed and provisioned in the EAGLE. SMs and E5-SM4G cards are shown by the entries `SM` in the `TYPE` column and `VSCCP` in the `APPL` column of the `rtrv-card` output.

Before the Weighted GTT Load Sharing feature can be enabled, the GTT feature must be turned on. The state of the GTT feature can be verified using the `rtrv-feat` command.

1. Display the status of the Weighted GTT Load Sharing feature by entering the `rtrv-ctrl-feat` command. The following is an example of the possible output.

```
rlghncxa03w 06-10-28 21:15:37 GMT EAGLE5 36.0.0
The following features have been permanently enabled:
```

Feature Name	Partnum	Status	Quantity
--------------	---------	--------	----------

```

Command Class Management 893005801 on ----
LNP Short Message Service 893006601 on ----
Intermed GTT Load Sharing 893006901 on ----
HC-MIM SLK Capacity      893012707 on 64
  
```

The following features have been temporarily enabled:

```

Feature Name          Partnum  Status  Quantity  Trial
Period Left
Zero entries found.
  
```

The following features have expired temporary keys:

```

Feature Name          Partnum
Zero entries found.
  
```

If the Weighted GTT Load Sharing feature is enabled and turned on, no further action is necessary. This procedure does not need to be performed.

If the Weighted GTT Load Sharing feature is enabled and but not turned on, skip steps 2 through 8 and go to step 9.

If the Weighted GTT Load Sharing feature is not enabled, go to step 2.

2. Verify that the GTT feature is on, by entering the `rtrv-feat` command. If the GTT feature is on, the `GTT` field should be set to `on`.

 **Note:**

The `rtrv-feat` command output contains other fields that are not used by this procedure. If you wish to see all the fields displayed by the `rtrv-feat` command, see the `rtrv-feat` command description in *Commands User's Guide*.

If the GTT feature is on, shown by the entry `GTT = on` in the `rtrv-feat` command output in step 2, go to step 3.

If the GTT feature is off, perform [Adding a Service Module](#) to turn the GTT feature on and add the required number of SMS or E5-SM4G cards. After [Adding a Service Module](#) is performed, skip step 3 and go to step 4.

3. Display the cards in the EAGLE using the `rtrv-card` command. The Weighted GTT Load Sharing feature requires that DSMs or E5-SM4G cards running the VSCCP application are in the database. This is an example of the possible output.

```

rlghncxa03w 13-05-25 09:58:31 GMT EAGLE5 45.0.0
CARD  TYPE      APPL      LSET NAME      PORT SLC LSET NAME
PORT SLC
1102  TSM          GLS
1113  E5MCAP      OAMHC
1114  E5TDM-A
1115  E5MCAP      OAMHC
1116  E5TDM-B
1117  E5MDAL
1201  LIMDS0     SS7ANSI  sp2            A    0    sp1
  
```

```

B      0
1203  LIMDS0  SS7ANSI  sp3          A      0
1204  LIMDS0  SS7ANSI  sp3          A      1
1206  LIMDS0  SS7ANSI  nsp3        A      1  nsp4
B      1
1301  DSM     VSCCP
1303  DSM     VSCCP
1305  DSM     VSCCP
1308  LIMDS0  SS7ANSI  sp6          A      1  sp7
B      0
1314  LIMDS0  SS7ANSI  sp7          A      1  sp5
B      1

```

There are two types of service modules, SMs or E5-SM4G cards running the VSCCP application.

SMs and E5-SM4G cards are shown by the entries `SM` in the `TYPE` column and `VSCCP` in the `APPL` column.

If SMs or E5-SM4G cards running the VSCCP application are in the EAGLE, go to step 4.

 **Note:**

If the `rtrv-ctrl-feat` output in step 1 shows any controlled features, skip steps 4 through 7, and go to step 8. If the `rtrv-ctrl-feat` output shows only the HC-MIM SLK Capacity feature with a quantity of 64, steps 4 through 7 must be performed.

4. Display the serial number in the database with the `rtrv-serial-num` command. This is an example of the possible output.

```

rlghncxa03w 06-10-28 21:15:37 GMT EAGLE5 36.0.0
System serial number = nt00001231

System serial number is not locked.

rlghncxa03w 06-10-28 21:15:37 GMT EAGLE5 36.0.0
Command Completed.

```

 **Note:**

If the serial number is correct and locked, skip steps 5, 6, and 7, and go to step 8. If the serial number is correct but not locked, skip steps 5 and 6, and go to step 7. If the serial number is not correct, but is locked, this feature cannot be enabled and the remainder of this procedure cannot be performed. Contact the Customer Care Center to get an incorrect and locked serial number changed. Refer to [#unique_17](#) for the contact information. The serial number can be found on a label affixed to the control shelf (shelf 1100).

5. Enter the correct serial number into the database using the `ent-serial-num` command with the `serial` parameter.

For this example, enter this command.

```
ent-serial-num:serial=<EAGLE's correct serial number>
```

When this command has successfully completed, the following message should appear.

```
rlghncxa03w 06-10-28 21:15:37 GMT EAGLE5 36.0.0  
ENT-SERIAL-NUM: MASP A - COMPLTD
```

6. Verify that the serial number entered into step 5 was entered correctly using the `rtrv-serial-num` command. This is an example of the possible output.

```
rlghncxa03w 06-10-28 21:15:37 GMT EAGLE5 36.0.0  
System serial number = nt00001231
```

System serial number is not locked.

```
rlghncxa03w 06-10-28 21:15:37 GMT EAGLE5 36.0.0  
Command Completed.
```

If the serial number was not entered correctly, repeat steps 5 and 6 and re-enter the correct serial number.

7. Lock the serial number in the database by entering the `ent-serial-num` command with the serial number shown in step 4, if the serial number shown in step 4 is correct, or with the serial number shown in step 6, if the serial number was changed in step 5, and with the `lock=yes` parameter.

For this example, enter this command.

```
ent-serial-num:serial=<EAGLE's serial number>:lock=yes
```

When this command has successfully completed, the following message should appear.

```
rlghncxa03w 06-10-28 21:15:37 GMT EAGLE5 36.0.0  
ENT-SERIAL-NUM: MASP A - COMPLTD
```

8. Enable the Weighted GTT Load Sharing feature with the `enable-ctrl-feat` command specifying the part number for the Weighted GTT Load Sharing feature and the feature access key. Enter this command.

```
enable-ctrl-feat:partnum=893017001:fak=<Weighted GTT Load  
Sharing feature access key>
```

 **Note:**

The Weighted GTT Load Sharing feature cannot be enabled with a temporary feature access key.

 **Note:**

The feature access key (the `fak` parameter) is provided. If you do not have the feature access key for the Weighted GTT Load Sharing feature, contact your Sales Representative or Account Representative.

When the `enable-ctrl-feat` command has successfully completed, this message should appear.

```
rlghncxa03w 06-10-28 21:15:37 GMT EAGLE5 36.0.0
ENABLE-CTRL-FEAT: MASP B - COMPLTD
```

9. Turn the Weighted GTT Load Sharing feature on with the `chg-ctrl-feat` command specifying the part number for the Weighted GTT Load Sharing feature and the `status=on` parameter. Enter this command.

```
chg-ctrl-feat:partnum=893017001:status=on
```

 **Note:**

Once this feature is turned on, it cannot be turned off.

When the `chg-ctrl-feat` command has successfully completed, this message should appear.

```
rlghncxa03w 06-10-28 21:15:37 GMT EAGLE5 36.0.0
CHG-CTRL-FEAT: MASP B - COMPLTD
```

10. Verify the changes by entering the `rtrv-ctrl-feat` command with the Weighted GTT Load Sharing feature part number. Enter this command.

```
rtrv-ctrl-feat:partnum=893017001
```

The following is an example of the possible output.

```
rlghncxa03w 06-10-28 21:15:37 GMT EAGLE5 36.0.0
The following features have been permanently enabled:
```

Feature Name	Partnum	Status	Quantity
Weighted GTT Load-Sharing	893017001	on	----

The following features have been temporarily enabled:

Feature Name	Partnum	Status	Quantity	Trial
Period Left				
Zero entries found.				

The following features have expired temporary keys:

Feature Name	Partnum
Zero entries found.	

11. Backup the new changes using the `chg-db:action=backup:dest=fixed` command. These messages should appear, the active Maintenance and Administration Subsystem Processor (MASP) appears first.

```
BACKUP (FIXED) : MASP A - Backup starts on active MASP.  
BACKUP (FIXED) : MASP A - Backup on active MASP to fixed disk  
complete.  
BACKUP (FIXED) : MASP A - Backup starts on standby MASP.  
BACKUP (FIXED) : MASP A - Backup on standby MASP to fixed disk  
complete.
```

Figure 5-31 Activate the Weighted GTT Load Sharing Feature - Sheet 1 of 5

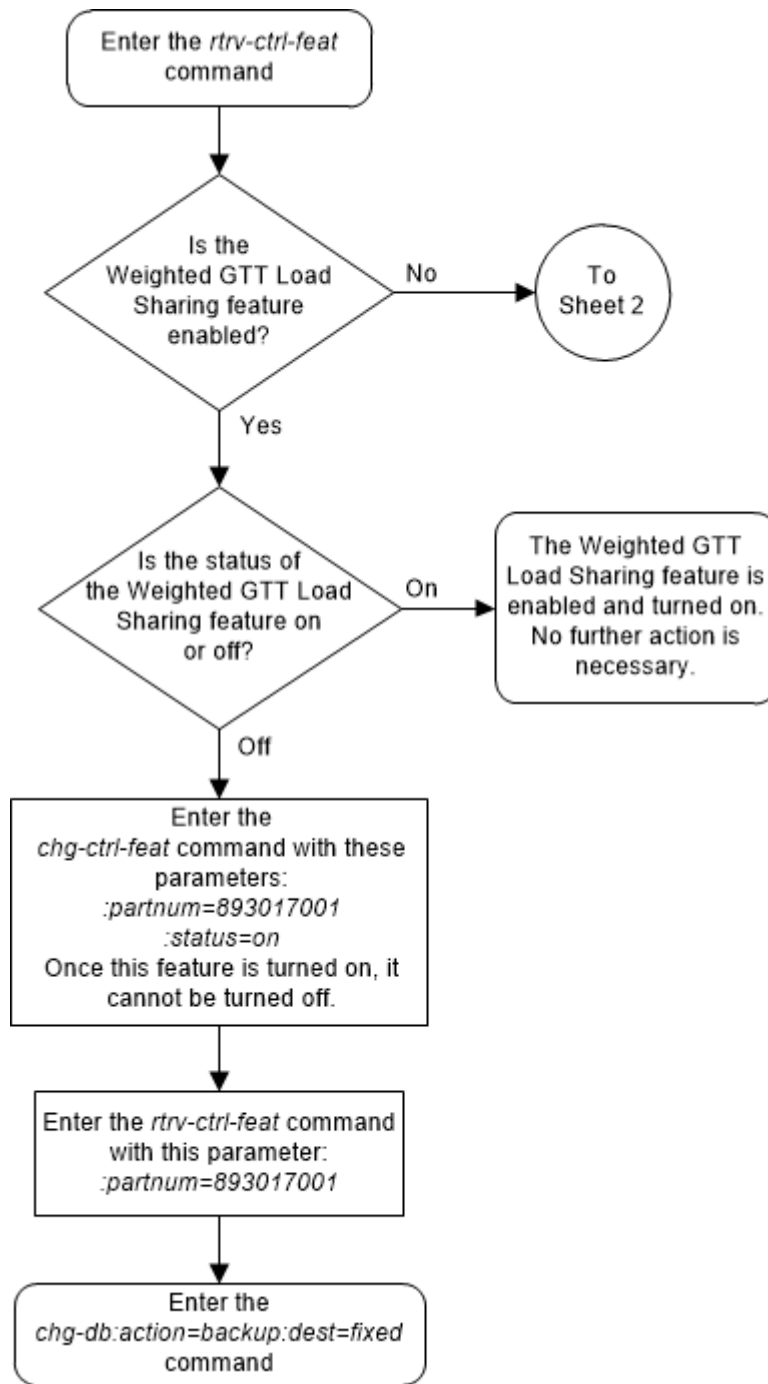

Figure 5-32 Activate the Weighted GTT Load Sharing Feature - Sheet 2 of 5

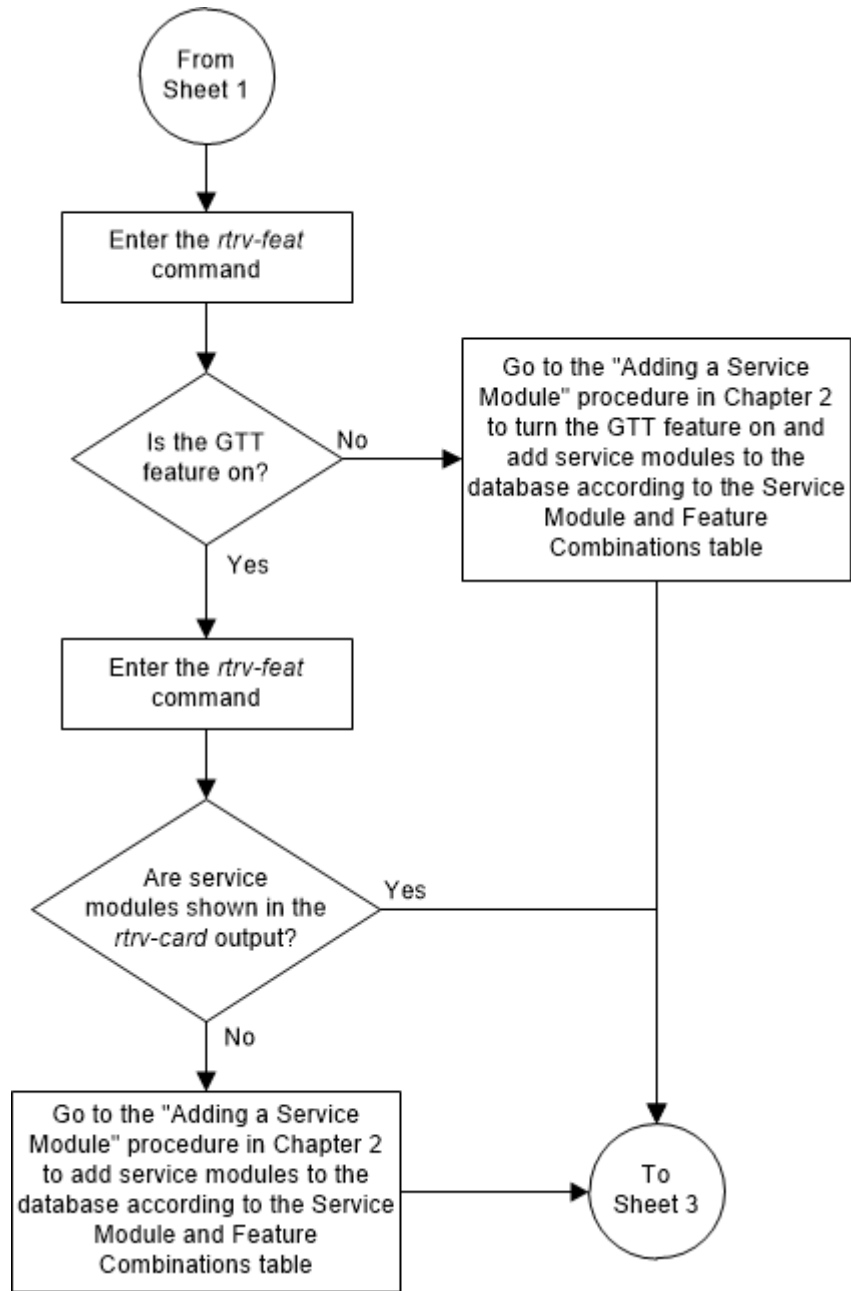

Figure 5-33 Activate the Weighted GTT Load Sharing Feature - Sheet 3 of 5

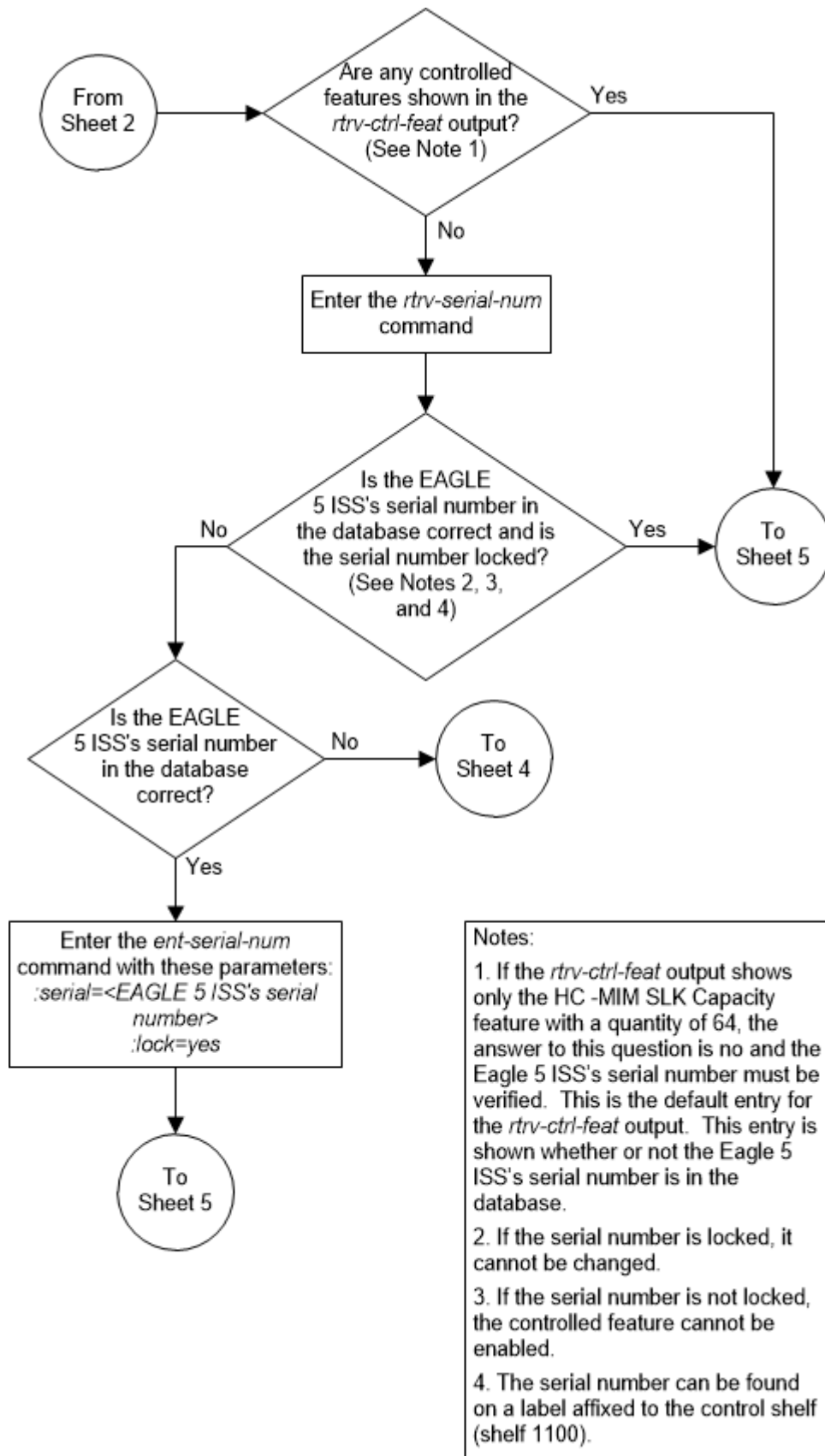

Figure 5-34 Activate the Weighted GTT Load Sharing Feature - Sheet 4 of 5

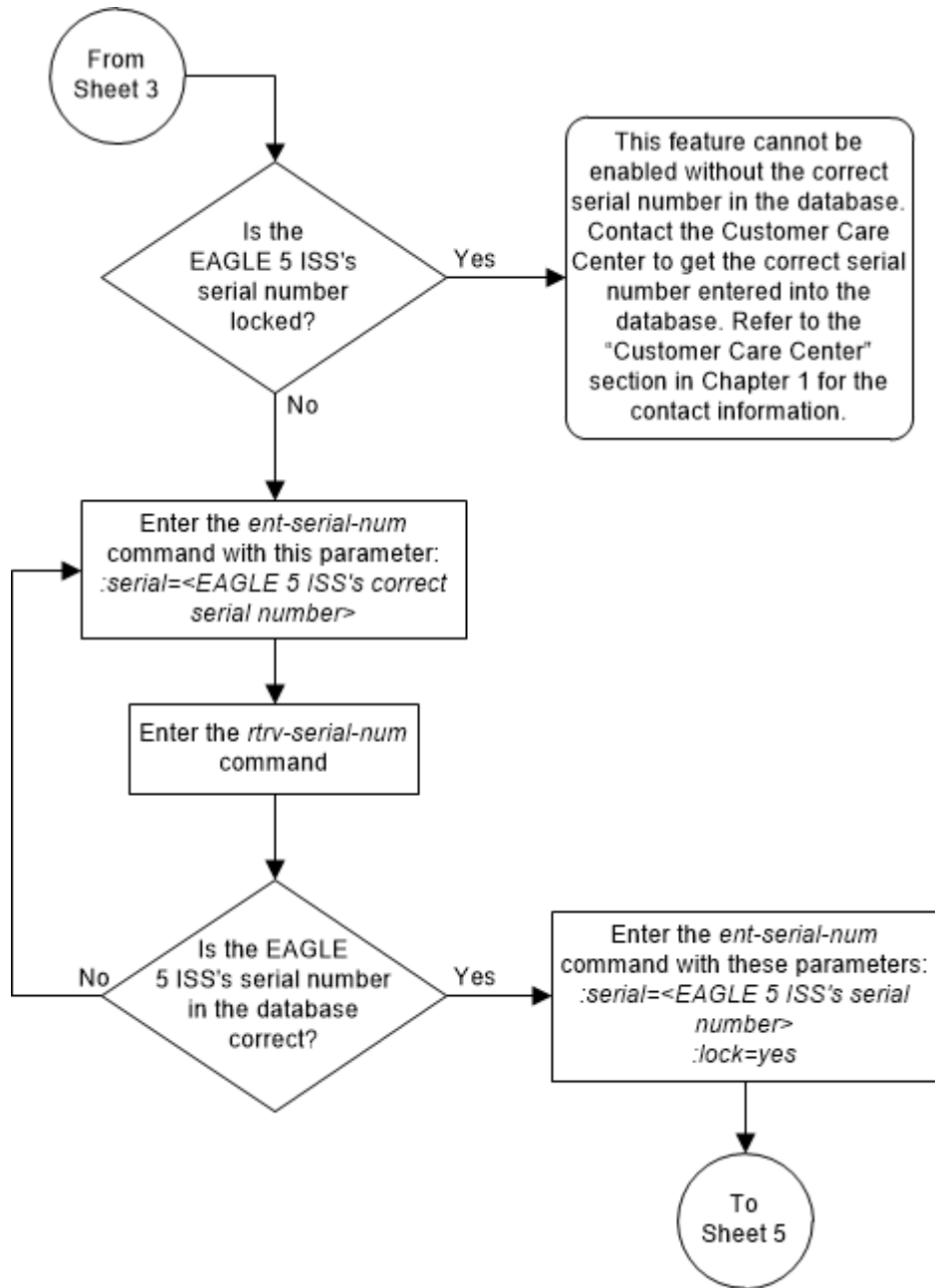
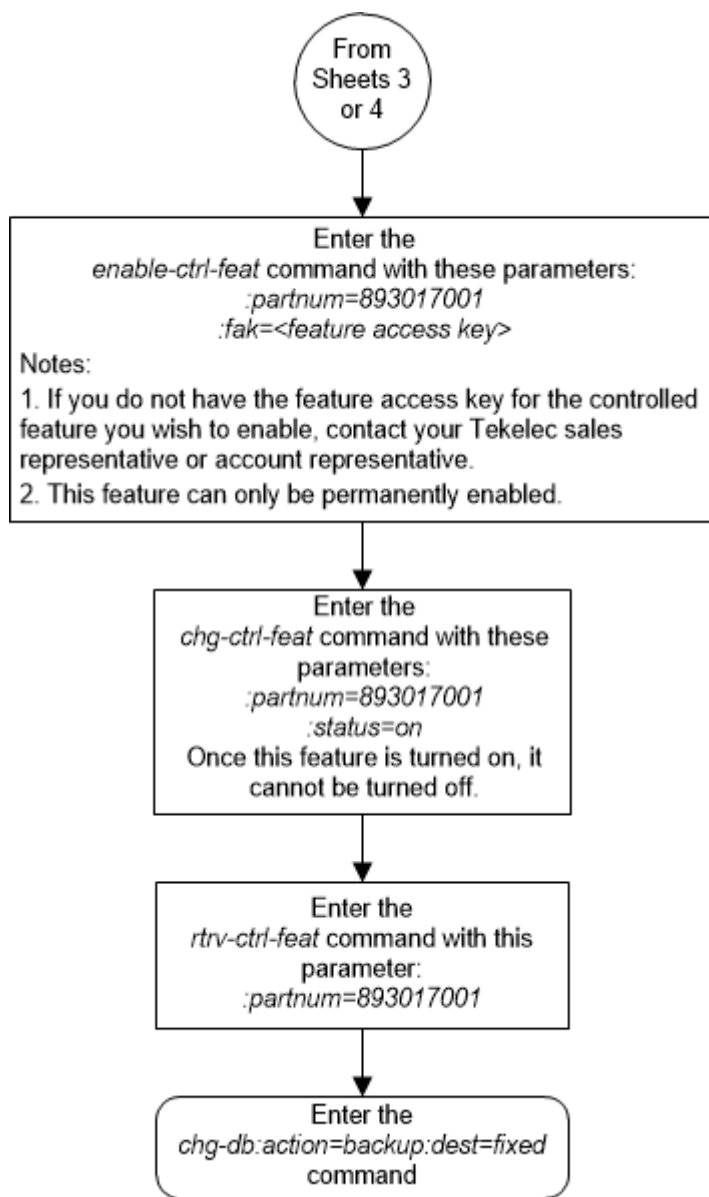

Figure 5-35 Activate the Weighted GTT Load Sharing Feature - Sheet 5 of 5



Activating the Transaction-Based GTT Load Sharing Feature

This procedure is used to enable and turn on the Transaction-Based GTT Load Sharing feature using the feature's part number and a feature access key.

The feature access key for the Transaction-Based GTT Load Sharing feature is based on the feature's part number and the serial number of the EAGLE, making the feature access key site-specific.

The `enable-ctrl-feat` command enables the feature by inputting the feature's access key and the feature's part number with these parameters:

:*fak* – The feature access key provided. The feature access key contains 13 alphanumeric characters and is not case sensitive.

:*partnum* – The issued part number of the Transaction-Based GTT Load Sharing feature, 893017101.

The *enable-ctrl-feat* command requires that the database contain a valid serial number for the EAGLE, and that this serial number is locked. This can be verified with the *rtrv-serial-num* command. The EAGLE is shipped with a serial number in the database, but the serial number is not locked. The serial number can be changed, if necessary, and locked once the EAGLE is on-site, with the *ent-serial-num* command. The *ent-serial-num* command uses these parameters.

:*serial* – The serial number assigned to the EAGLE. The serial number is not case sensitive.

:*lock* – Specifies whether or not the serial number is locked. This parameter has only one value, *yes*, which locks the serial number. Once the serial number is locked, it cannot be changed.

 **Note:**

To enter and lock the EAGLE's serial number, the *ent-serial-num* command must be entered twice, once to add the correct serial number to the database with the *serial* parameter, then again with the *serial* and the *lock=yes* parameters to lock the serial number. You should verify that the serial number in the database is correct before locking the serial number. The serial number can be found on a label affixed to the control shelf (shelf 1100).

This feature cannot be temporarily enabled (with the temporary feature access key).

Once this feature is enabled, provisioning for this feature can be performed, but the feature will not work until the feature is turned on with the *chg-ctrl-feat* command.

Once this feature has been enabled, the feature must be turned on with the *chg-ctrl-feat* command. The *chg-ctrl-feat* command uses these parameters:

:*partnum* – The issued part number of the Transaction-Based GTT Load Sharing feature, 893017101.

:*status=on* – used to turn the Transaction-Based GTT Load Sharing feature on.

Once the Transaction-Based GTT Load Sharing feature has been turned on, it be cannot be turned off.

The status of the features in the EAGLE is shown with the *rtrv-ctrl-feat* command.

The Transaction-Based GTT Load Sharing feature requires that SMs or E5-SM4G cards are installed and provisioned in the EAGLE. SMs and E5-SM4G cards are shown by the entries *SM* in the *TYPE* column and *VSCCP* in the *APPL* column of the *rtrv-card* output.

1. Display the status of the Transaction-Based GTT Load Sharing feature by entering the `rtrv-ctrl-feat` command. The following is an example of the possible output.

```
rlghncxa03w 06-10-28 21:15:37 GMT EAGLE5 36.0.0
The following features have been permanently enabled:
```

Feature Name	Partnum	Status	Quantity
Command Class Management	893005801	on	----
LNP Short Message Service	893006601	on	----
Intermed GTT Load Sharing	893006901	on	----
HC-MIM SLK Capacity	893012707	on	64

The following features have been temporarily enabled:

Feature Name	Partnum	Status	Quantity	Trial Period Left
Zero entries found.				

The following features have expired temporary keys:

Feature Name	Partnum
Zero entries found.	

If the Transaction-Based GTT Load Sharing feature is enabled and turned on, no further action is necessary. This procedure does not need to be performed.

If the Transaction-Based GTT Load Sharing feature is enabled and but not turned on, skip steps 2 through 7 and go to step 8.

If the Transaction-Based GTT Load Sharing feature is not enabled, go to step 2.

2. Verify that the GTT feature is on, by entering the `rtrv-feat` command. If the GTT feature is on, the `GTT` field should be set to `on`.

 **Note:**

The `rtrv-feat` command output contains other fields that are not used by this procedure. If you wish to see all the fields displayed by the `rtrv-feat` command, see the `rtrv-feat` command description in *Commands User's Guide*.

If the GTT feature is on, shown by the entry `GTT = on` in the `rtrv-feat` command output in step 2, go to step 3.

If the GTT feature is off, perform [Adding a Service Module](#) to turn the GTT feature on and add the required number of SMS or E5-SM4G cards. After [Adding a Service Module](#) is performed, skip step 3 and go to step 4.

3. Display the cards in the EAGLE using the `rtrv-card` command. The Transaction-Based GTT Load Sharing feature requires that SMS or E5-SM4G

cards running the VSCCP application are in the database. This is an example of the possible output.

```
rlghncxa03w 13-05-25 09:58:31 GMT EAGLE5 45.0.0
CARD   TYPE      APPL      LSET NAME      PORT SLC LSET NAME
PORT SLC
1102   TSM          GLS
1113   E5MCAP       OAMHC
1114   E5TDM-A
1115   E5MCAP       OAMHC
1116   E5TDM-B
1117   E5MDAL
1201   LIMDS0       SS7ANSI   sp2            A    0    sp1
B      0
1203   LIMDS0       SS7ANSI   sp3            A    0
1204   LIMDS0       SS7ANSI   sp3            A    1
1301   DSM          VSCCP
1303   DSM          VSCCP
1305   DSM          VSCCP
1308   LIMDS0       SS7ANSI   sp6            A    1    sp7
B      0
1314   LIMDS0       SS7ANSI   sp7            A    1    sp5
B      1
```

There are two types of service modules, SMs or E5-SM4G cards running the VSCCP application.

SMs and E5-SM4G cards are shown by the entries `DSM` in the `TYPE` column and `VSCCP` in the `APPL` column.

If SMs or E5-SM4G cards running the VSCCP application are in the EAGLE, go to step 4.

 **Note:**

If the `rtrv-ctrl-feat` output in step 1 shows any controlled features, skip steps 4 through 7, and go to step 8. If the `rtrv-ctrl-feat` output shows only the HC-MIM SLK Capacity feature with a quantity of 64, steps 4 through 7 must be performed.

4. Display the serial number in the database with the `rtrv-serial-num` command. This is an example of the possible output.

```
rlghncxa03w 06-10-28 21:15:37 GMT EAGLE5 36.0.0
System serial number = nt00001231
```

System serial number is not locked.

```
rlghncxa03w 06-10-28 21:15:37 GMT EAGLE5 36.0.0
Command Completed.
```

 **Note:**

If the serial number is correct and locked, skip steps 5, 6, and 7, and go to step 8. If the serial number is correct but not locked, skip steps 5 and 6, and go to step 7. If the serial number is not correct, but is locked, this feature cannot be enabled and the remainder of this procedure cannot be performed. Contact the Customer Care Center to get an incorrect and locked serial number changed. Refer to [#unique_17](#) for the contact information. The serial number can be found on a label affixed to the control shelf (shelf 1100).

5. Enter the correct serial number into the database using the `ent-serial-num` command with the `serial` parameter.

For this example, enter this command.

```
ent-serial-num:serial=<EAGLE's correct serial number>
```

When this command has successfully completed, the following message should appear.

```
rlghncxa03w 06-10-28 21:15:37 GMT EAGLE5 36.0.0  
ENT-SERIAL-NUM: MASP A - COMPLTD
```

6. Verify that the serial number entered into step 5 was entered correctly using the `rtrv-serial-num` command. This is an example of the possible output.

```
rlghncxa03w 06-10-28 21:15:37 GMT EAGLE5 36.0.0  
System serial number = nt00001231
```

System serial number is not locked.

```
rlghncxa03w 06-10-28 21:15:37 GMT EAGLE5 36.0.0  
Command Completed.
```

If the serial number was not entered correctly, repeat steps 5 and 6 and re-enter the correct serial number.

7. Lock the serial number in the database by entering the `ent-serial-num` command with the serial number shown in step 4, if the serial number shown in step 4 is correct, or with the serial number shown in step 6, if the serial number was changed in step 5, and with the `lock=yes` parameter.

For this example, enter this command.

```
ent-serial-num:serial=<EAGLE's serial number>:lock=yes
```

When this command has successfully completed, the following message should appear.

```
rlghncxa03w 06-10-28 21:15:37 GMT EAGLE5 36.0.0  
ENT-SERIAL-NUM: MASP A - COMPLTD
```

8. Enable the Transaction-Based GTT Load Sharing feature with the `enable-ctrl-feat` command specifying the part number for the Transaction-Based GTT Load Sharing feature and the feature access key. Enter this command.

```
enable-ctrl-feat:partnum=893017101:fak=<Transaction-Based GTT
Load Sharing feature access key>
```

 **Note:**

The Transaction-Based GTT Load Sharing feature cannot be enabled with a temporary feature access key.

 **Note:**

The values for the feature access key (the `fak` parameter) are provided. If you do not have the feature access key for the Transaction-Based GTT Load Sharing feature, contact your Sales Representative or Account Representative.

When the `enable-ctrl-feat` command has successfully completed, this message should appear.

```
rlghncxa03w 06-10-28 21:15:37 GMT EAGLE5 36.0.0
ENABLE-CTRL-FEAT: MASP B - COMPLTD
```

 **Caution:**

Once the Transaction-Based GTT Load Sharing feature is enabled, provisioning for Transaction-Based GTT Load Sharing can be performed, but the EAGLE will not perform Transaction-Based GTT Load Sharing on GTT traffic until the Transaction-Based GTT Load Sharing is turned on in step 8.

 **Note:**

If you do not wish to turn the Transaction-Based GTT Load Sharing feature on, skip step 9 and go to step 10.

9. Turn the Transaction-Based GTT Load Sharing feature on with the `chg-ctrl-feat` command specifying the part number for the Transaction-Based GTT Load Sharing feature and the `status=on` parameter.

Enter this command.

```
chg-ctrl-feat:partnum=893017101:status=on
```

 **Note:**

Once this feature is turned on, it cannot be turned off.

When the `chg-ctrl-feat` command has successfully completed, this message should appear.

```
rlghncxa03w 06-10-28 21:15:37 GMT EAGLE5 36.0.0
CHG-CTRL-FEAT: MASP B - COMPLTD
```

10. Verify the changes by entering the `rtrv-ctrl-feat` command with the Transaction-Based GTT Load Sharing feature part number. Enter this command.

```
rtrv-ctrl-feat:partnum=893017101
```

The following is an example of the possible output.

```
rlghncxa03w 06-10-28 21:15:37 GMT EAGLE5 36.0.0
The following features have been permanently enabled:
```

Feature Name	Partnum	Status	Quantity
Transaction Based GTT LS	893017101	on	----

The following features have been temporarily enabled:

Feature Name	Partnum	Status	Quantity	Trial
Period Left				
Zero entries found.				

The following features have expired temporary keys:

Feature Name	Partnum
Zero entries found.	

11. Backup the new changes using the `chg-db:action=backup:dest=fixed` command. These messages should appear, the active Maintenance and Administration Subsystem Processor (MASP) appears first.

```
BACKUP (FIXED) : MASP A - Backup starts on active MASP.
BACKUP (FIXED) : MASP A - Backup on active MASP to fixed disk
complete.
BACKUP (FIXED) : MASP A - Backup starts on standby MASP.
BACKUP (FIXED) : MASP A - Backup on standby MASP to fixed disk
complete.
```

Figure 5-36 Activate the Transaction-Based GTT Load Sharing Feature - Sheet 1 of 5

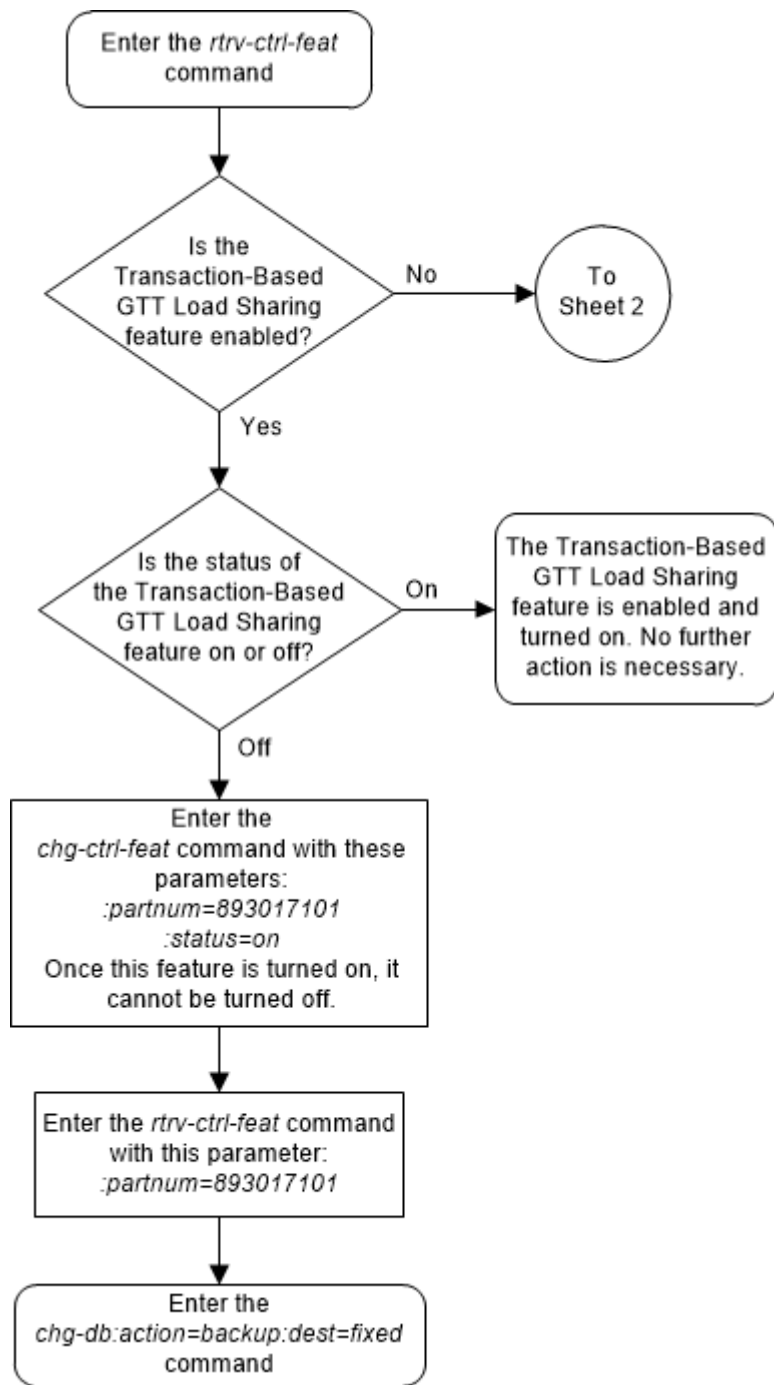

Figure 5-37 Activate the Transaction-Based GTT Load Sharing Feature - Sheet 2 of 5

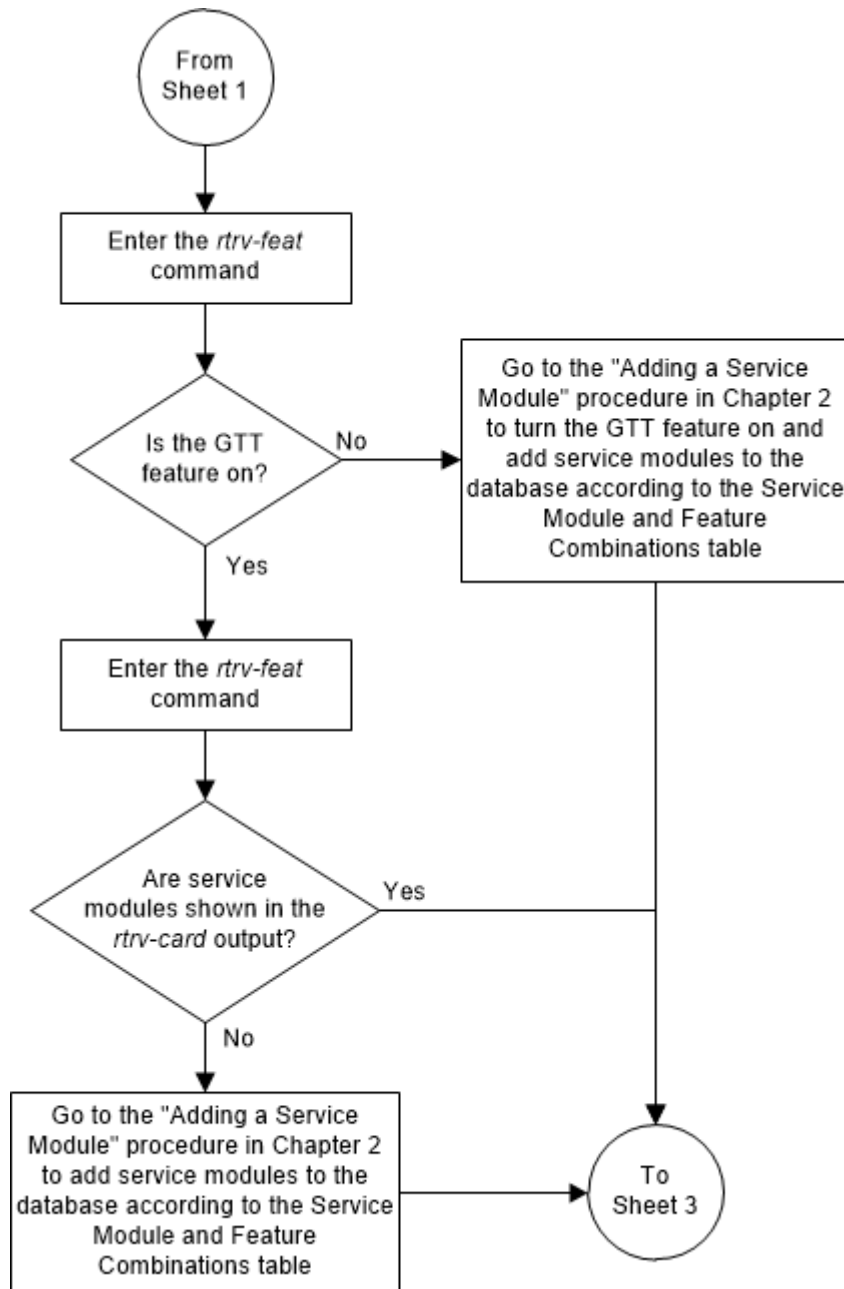

Figure 5-38 Activate the Transaction-Based GTT Load Sharing Feature - Sheet 3 of 5

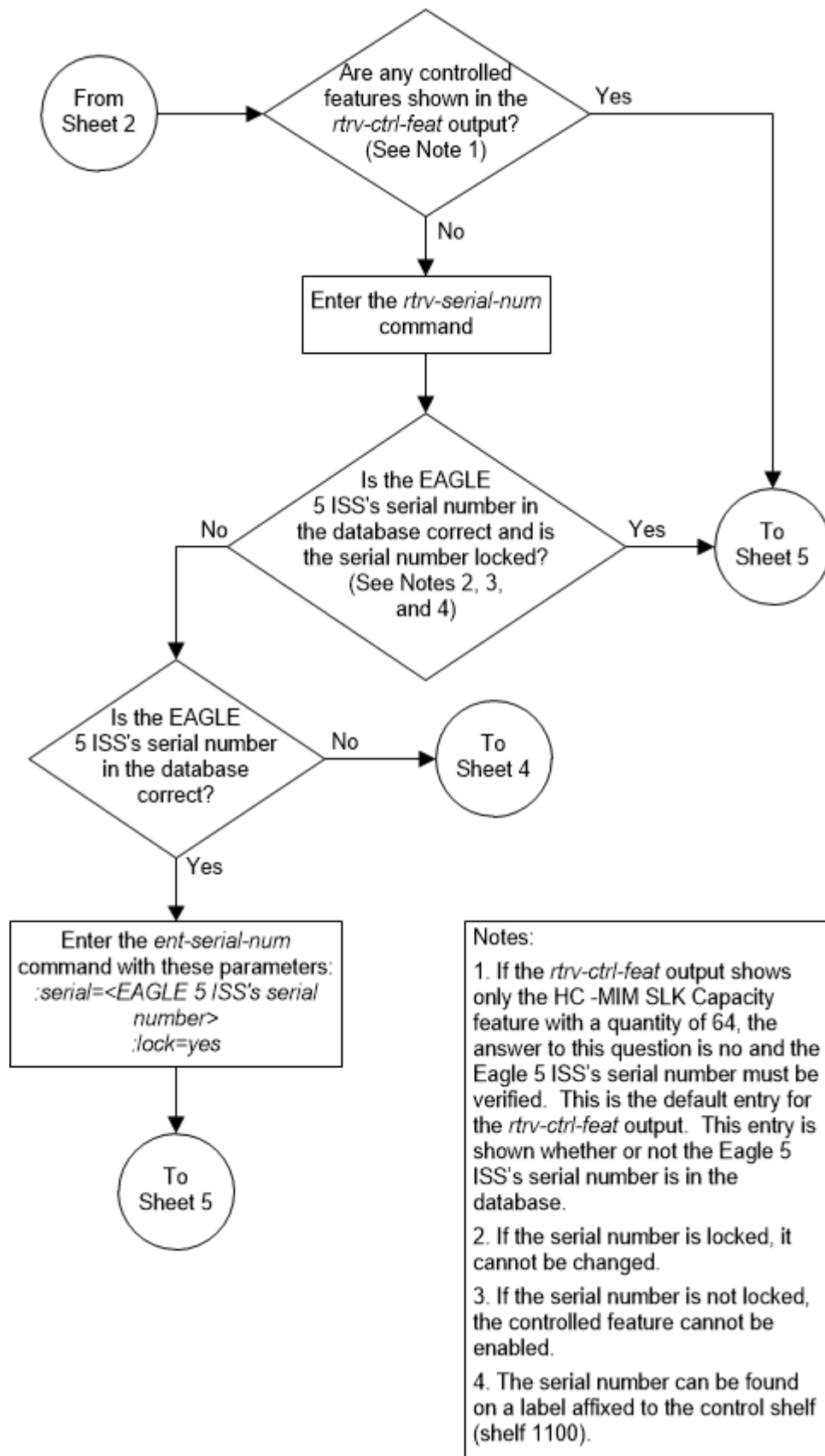

Figure 5-39 Activate the Transaction-Based GTT Load Sharing Feature - Sheet 4 of 5

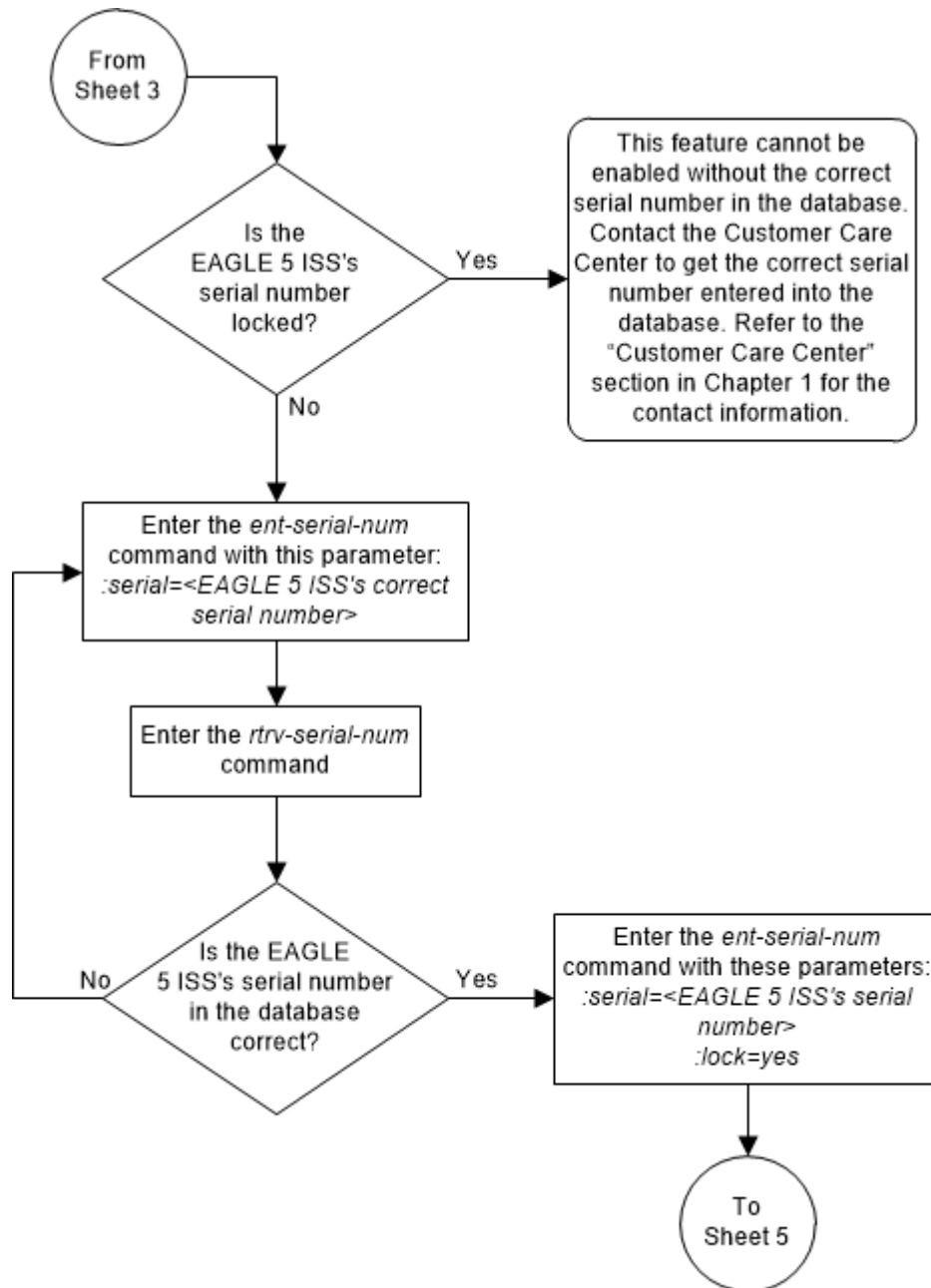
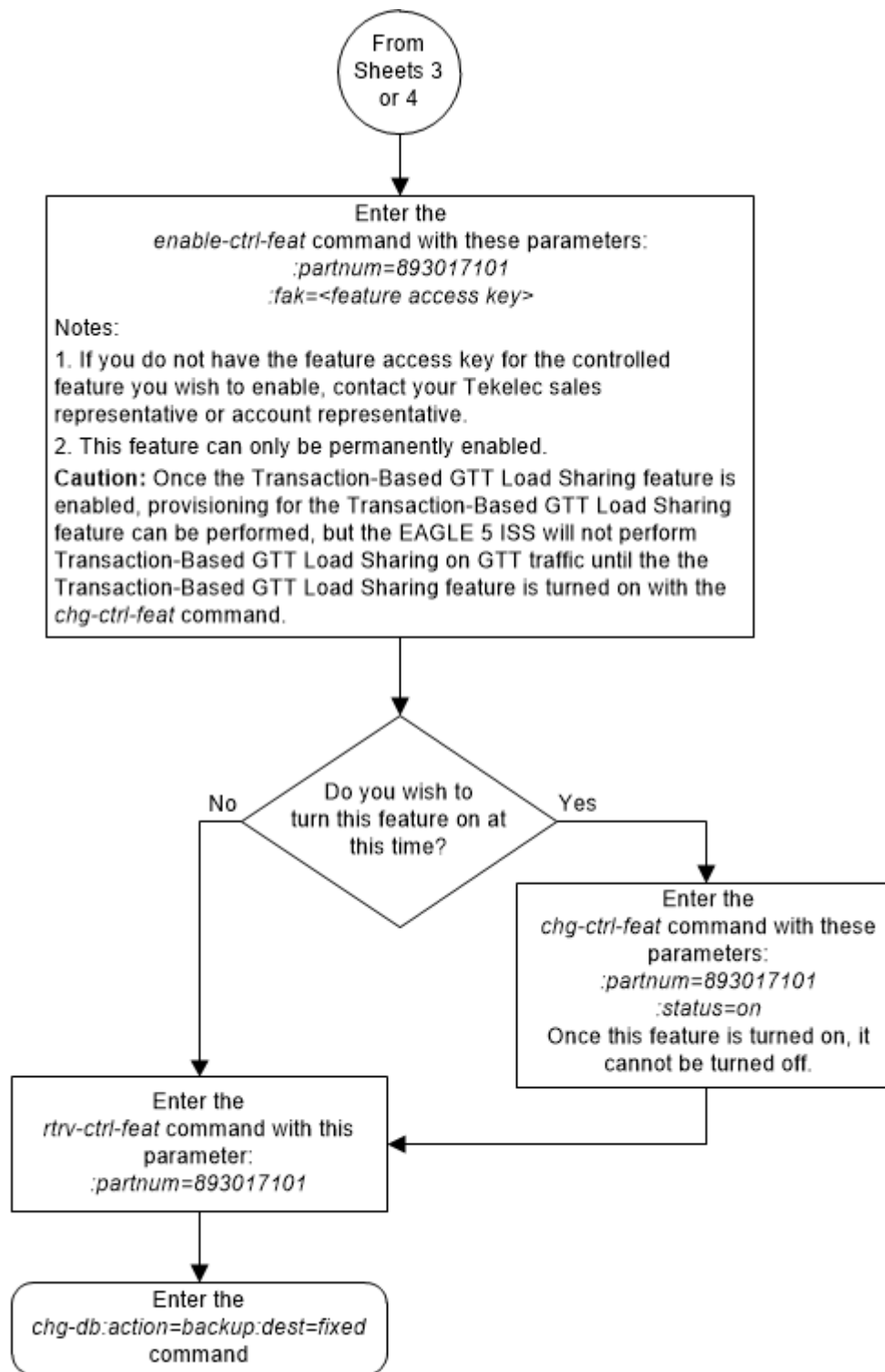

Figure 5-40 Activate the Transaction-Based GTT Load Sharing Feature - Sheet 5 of 5



Activating the SCCP Loop Detection Feature

This procedure is used to enable and turn on the SCCP Loop Detection feature using the feature's part number and a feature access key.

The feature access key for the SCCP Loop Detection feature is based on the feature's part number and the serial number of the EAGLE, making the feature access key site-specific.

The `enable-ctrl-feat` command enables the feature by inputting the feature's access key and the feature's part number with these parameters:

`:fak` – The feature access key provided. The feature access key contains 13 alphanumeric characters and is not case sensitive.

`:partnum` – The issued part number of the SCCP Loop Detection feature, 893016501.

The `enable-ctrl-feat` command requires that the database contain a valid serial number for the EAGLE, and that this serial number is locked. This can be verified with the `rtrv-serial-num` command. The EAGLE is shipped with a serial number in the database, but the serial number is not locked. The serial number can be changed, if necessary, and locked once the EAGLE is on-site, with the `ent-serial-num` command. The `ent-serial-num` command uses these parameters.

`:serial` – The serial number assigned to the EAGLE. The serial number is not case sensitive.

`:lock` – Specifies whether or not the serial number is locked. This parameter has only one value, `yes`, which locks the serial number. Once the serial number is locked, it cannot be changed.

Note:

To enter and lock the EAGLE's serial number, the `ent-serial-num` command must be entered twice, once to add the correct serial number to the database with the `serial` parameter, then again with the `serial` and the `lock=yes` parameters to lock the serial number. You should verify that the serial number in the database is correct before locking the serial number. The serial number can be found on a label affixed to the control shelf (shelf 1100).

This feature cannot be temporarily enabled (with the temporary feature access key).

Once this feature is enabled, provisioning for this feature can be performed, but the feature will not work until the feature is turned on with the `chg-ctrl-feat` command. The `chg-ctrl-feat` command uses these parameters:

`:partnum` – The issued part number of the SCCP Loop Detection feature, 893016501.

`:status=on` – used to turn the SCCP Loop Detection feature on.

Once the SCCP Loop Detection feature has been turned on, it cannot be turned off.

The status of the features in the EAGLE is shown with the `rtrv-ctrl-feat` command.

Once the SCCP Loop Detection feature is turned on, SCCP Loop Detection is performed on MSUs requiring global title translation. For more information on the SCCP Loop Detection feature, refer to the [SCCP Loop Detection](#) section.

1. Display the status of the SCCP Loop Detection feature by entering the `rtrv-ctrl-feat` command. The following is an example of the possible output.

```
rlghncxa03w 06-10-28 21:15:37 GMT EAGLE5 36.0.0
The following features have been permanently enabled:
```

Feature Name	Partnum	Status	Quantity
HC-MIM SLK Capacity	893012707	on	64
Intermed GTT Load Sharing	893006901	on	----
G-Port Circ Route Prevent	893007001	on	----
Network Security Enhance	893009101	off	----
EAGLE OA&M IP Security	893400001	off	----
Flexible GTT Load-Sharing	893015401	on	----
Origin Based SCCP Routing	893014301	on	----
SCCP Loop Detection	893016501	on	----

The following features have been temporarily enabled:

Feature Name	Partnum	Status	Quantity	Trial Period Left
Zero entries found.				

The following features have expired temporary keys:

Feature Name	Partnum
Zero entries found.	

If the SCCP Loop Detection feature is enabled and turned on, no further action is necessary. This procedure does not need to be performed.

If the SCCP Loop Detection feature is enabled and but not turned on, skip steps 2 through 9 and go to step 10.

If the SCCP Loop Detection feature is not enabled, go to step 2.

2. Verify that the GTT feature is on, by entering the `rtrv-feat` command. If the GTT feature is on, the `GTT` field should be set to `on`.

Note:

The `rtrv-feat` command output contains other fields that are not used by this procedure. If you wish to see all the fields displayed by the `rtrv-feat` command, see the `rtrv-feat` command description in *Commands User's Guide*.

If the GTT feature is on, shown by the entry `GTT = on` in the `rtrv-feat` command output in skip step 3 and go to step 4.

If the GTT feature is off, perform step 3 to turn the GTT feature on.

3. Turn the global title translation feature on by entering this command.

```
chg-feat:gtt=on
```

NOTE: Once the Global Title Translation (GTT) feature is turned on with the `chg-feat` command, it cannot be turned off. The GTT feature must be purchased before turning it on. If you are not sure whether you have purchased the GTT feature, contact your Sales Representative or Account Representative.

When the `chg-feat` command has successfully completed, this message should appear.

```
rlghncxa03w 07-03-25 09:57:41 GMT EAGLE5 35.6.0
CHG-FEAT: MASP A - COMPLTD
```

4. Display the cards in the EAGLE using the `rtrv-card` command. The SCCP Loop Detection feature requires that SMs or E5-SM4G cards running the VSCCP application are in the database. This is an example of the possible output.

```
rlghncxa03w 13-05-25 09:58:31 GMT EAGLE5 45.0.0
CARD   TYPE      APPL      LSET NAME      PORT SLC LSET NAME
PORT SLC
1102   TSM         GLS
1113   E5MCAP     OAMHC
1114   E5TDM-A
1115   E5MCAP     OAMHC
1116   E5TDM-B
1117   E5MDAL
1201   LIMDS0     SS7ANSI   sp2             A    0    sp1
B      0
1203   LIMDS0     SS7ANSI   sp3             A    0
1204   LIMDS0     SS7ANSI   sp3             A    1
1206   LIMDS0     SS7ANSI   nsp3           A    1    nsp4
B      1
1301   DSM        VSCCP
1303   DSM        VSCCP
1305   DSM        VSCCP
1308   LIMDS0     SS7ANSI   sp6             A    1    sp7
B      0
1314   LIMDS0     SS7ANSI   sp7             A    1    sp5
B      1
```

There are two types of service modules, SMs or E5-SM4G cards running the VSCCP application.

SMs and E5-SM4G cards are shown by the entries `SM` in the `TYPE` column and `VSCCP` in the `APPL` column.

If no service modules are shown in the `rtrv-card` output, perform [Adding a Service Module](#) to add SMs or E5-SM4G cards to the EAGLE.

If SMs or E5-SM4G cards running the VSCCP application are in the EAGLE, go to step 5.

 **Note:**

If the `rtrv-ctrl-feat` output in step 1 shows any controlled features, skip steps 5 through 8, and go to step 9. If the `rtrv-ctrl-feat` output shows only the HC-MIM SLK Capacity feature with a quantity of 64, steps 5 through 8 must be performed.

5. Display the serial number in the database with the `rtrv-serial-num` command. This is an example of the possible output.

```
rlghncxa03w 06-10-28 21:15:37 GMT EAGLE5 36.0.0
System serial number = nt00001231
```

System serial number is not locked.

```
rlghncxa03w 06-10-28 21:15:37 GMT EAGLE5 36.0.0
Command Completed.
```

 **Note:**

If the serial number is correct and locked, continue the procedure with [EAGLE](#). If the serial number is correct but not locked, continue the procedure with [8](#). If the serial number is not correct, but is locked, this feature cannot be enabled and the remainder of this procedure cannot be performed. Contact the Customer Care Center to get an incorrect and locked serial number changed. Refer to [#unique_17](#) for the contact information. The serial number can be found on a label affixed to the control shelf (shelf 1100).

6. Enter the correct serial number into the database using the `ent-serial-num` command with the `serial` parameter.

For this example, enter this command.

```
ent-serial-num:serial=<EAGLE's correct serial number>
```

When this command has successfully completed, the following message should appear.

```
rlghncxa03w 06-10-28 21:15:37 GMT EAGLE5 36.0.0
ENT-SERIAL-NUM: MASP A - COMPLTD
```

7. Verify the serial number entered into was entered correctly using the `rtrv-serial-num` command. This is an example of the possible output.

```
rlghncxa03w 06-10-28 21:15:37 GMT EAGLE5 36.0.0
System serial number = nt00001231
```

System serial number is not locked.

```
rlghncxa03w 06-10-28 21:15:37 GMT EAGLE5 36.0.0
Command Completed.
```

If the serial number was not entered correctly, repeat steps 6 and 7 and re-enter the correct serial number.

8. Lock the serial number in the database by entering the `ent-serial-num` command with the serial number shown in , if the serial number shown in is correct, or with the serial number shown in , if the serial number was changed in , and with the `lock=yes` parameter.

For this example, enter this command.

```
ent-serial-num:serial=<EAGLE's serial number>:lock=yes
```

When this command has successfully completed, the following message should appear.

```
rlghncxa03w 06-10-28 21:15:37 GMT EAGLE5 36.0.0  
ENT-SERIAL-NUM: MASP A - COMPLTD
```

9. Enable the SCCP Loop Detection feature with the `enable-ctrl-feat` command specifying the part number for the SCCP Loop Detection feature and the feature access key. Enter this command.

```
enable-ctrl-feat:partnum=893016501:fak=<SCCP Loop Detection  
feature access key>
```

 **Note:**

The SCCP Loop Detection feature cannot be enabled with a temporary feature access key.

 **Note:**

The values for the feature access key (the `fak` parameter) are provided by . If you do not have the feature access key for the SCCP Loop Detection feature, contact your Sales Representative or Account Representative.

 **Caution:**

Once the SCCP Loop Detection feature is enabled, provisioning for SCCP Loop Detection can be performed, but the EAGLE will not perform SCCP Loop Detection on GTT traffic until the SCCP Loop Detection feature is turned on in step 10.

When the `enable-ctrl-feat` command has successfully completed, this message should appear.

```
rlghncxa03w 06-10-28 21:15:37 GMT EAGLE5 36.0.0  
ENABLE-CTRL-FEAT: MASP B - COMPLTD
```

10. Turn the SCCP Loop Detection feature on with the `chg-ctrl-feat` command specifying the part number for the SCCP Loop Detection feature and the `status=on` parameter.

Enter this command.

```
chg-ctrl-feat:partnum=893016501:status=on
```



Note:

Once this feature is turned on, it cannot be turned off.

When the `chg-crtl-feat` command has successfully completed, this message should appear.

```
rlghncxa03w 06-10-28 21:15:37 GMT EAGLE5 36.0.0
CHG-CTRL-FEAT: MASP B - COMPLTD
```

11. Verify the changes by entering the `rtrv-ctrl-feat` command with the SCCP Loop Detection feature part number. Enter this command.

```
rtrv-ctrl-feat:partnum=893016501
```

The following is an example of the possible output.

```
rlghncxa03w 07-03-28 21:15:37 GMT EAGLE5 35.6.0
The following features have been permanently enabled:
```

Feature Name	Partnum	Status	Quantity
SCCP Loop Detection	8930165101	on	----

The following features have been temporarily enabled:

Feature Name	Partnum	Status	Quantity	Trial
Period Left				
Zero entries found.				

The following features have expired temporary keys:

Feature Name	Partnum
Zero entries found.	

12. Back up the new changes using the `chg-db:action=backup:dest=fixed` command. These messages should appear, the active Maintenance and Administration Subsystem Processor (MASP) appears first.

```
BACKUP (FIXED) : MASP A - Backup starts on active MASP.
BACKUP (FIXED) : MASP A - Backup on active MASP to fixed disk
complete.
BACKUP (FIXED) : MASP A - Backup starts on standby MASP.
BACKUP (FIXED) : MASP A - Backup on standby MASP to fixed disk
complete.
```

Figure 5-41 Activate the SCCP Loop Detection Feature - Sheet 1 of 5

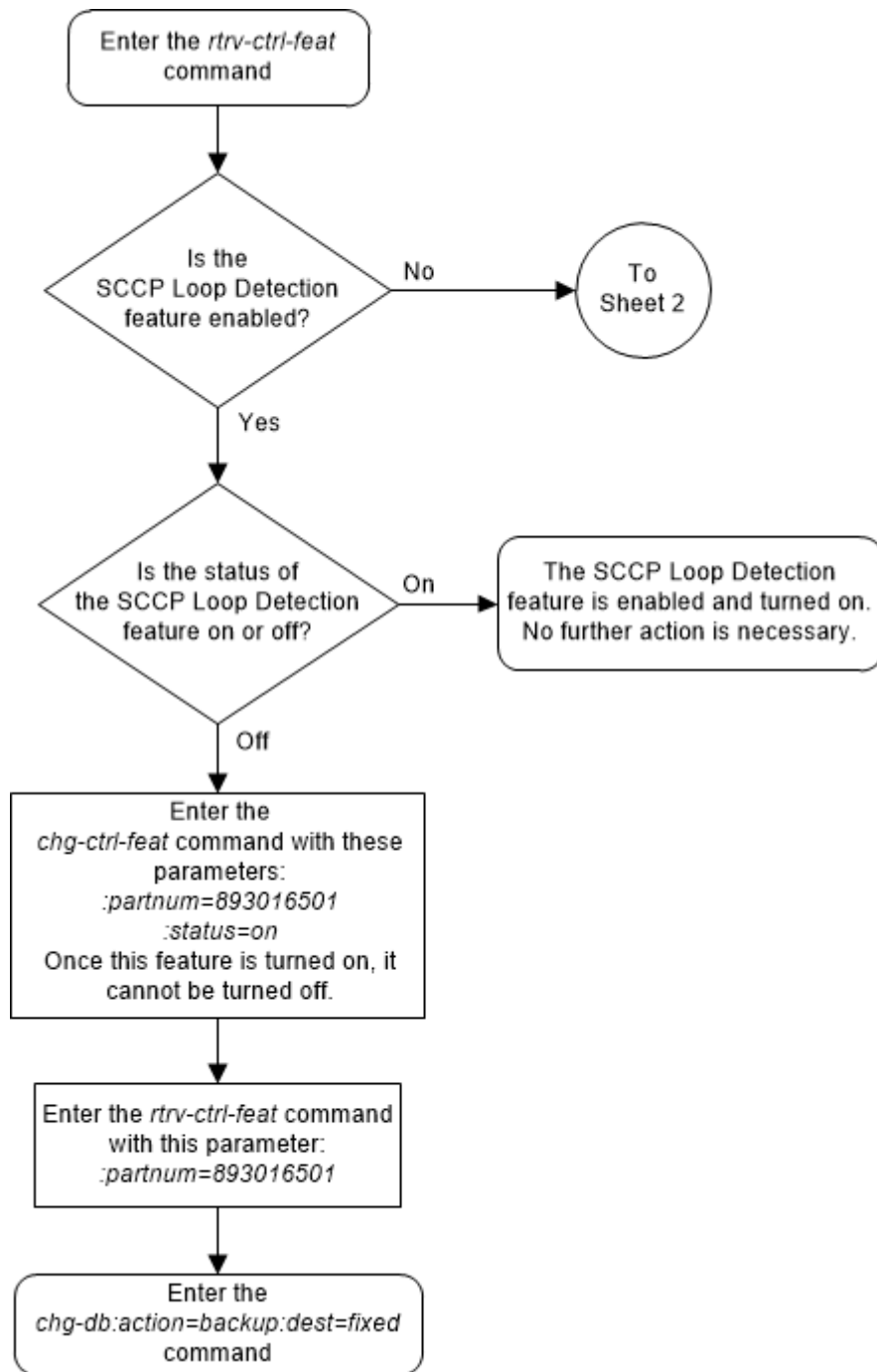

Figure 5-42 Activate the SCCP Loop Detection Feature - Sheet 2 of 5

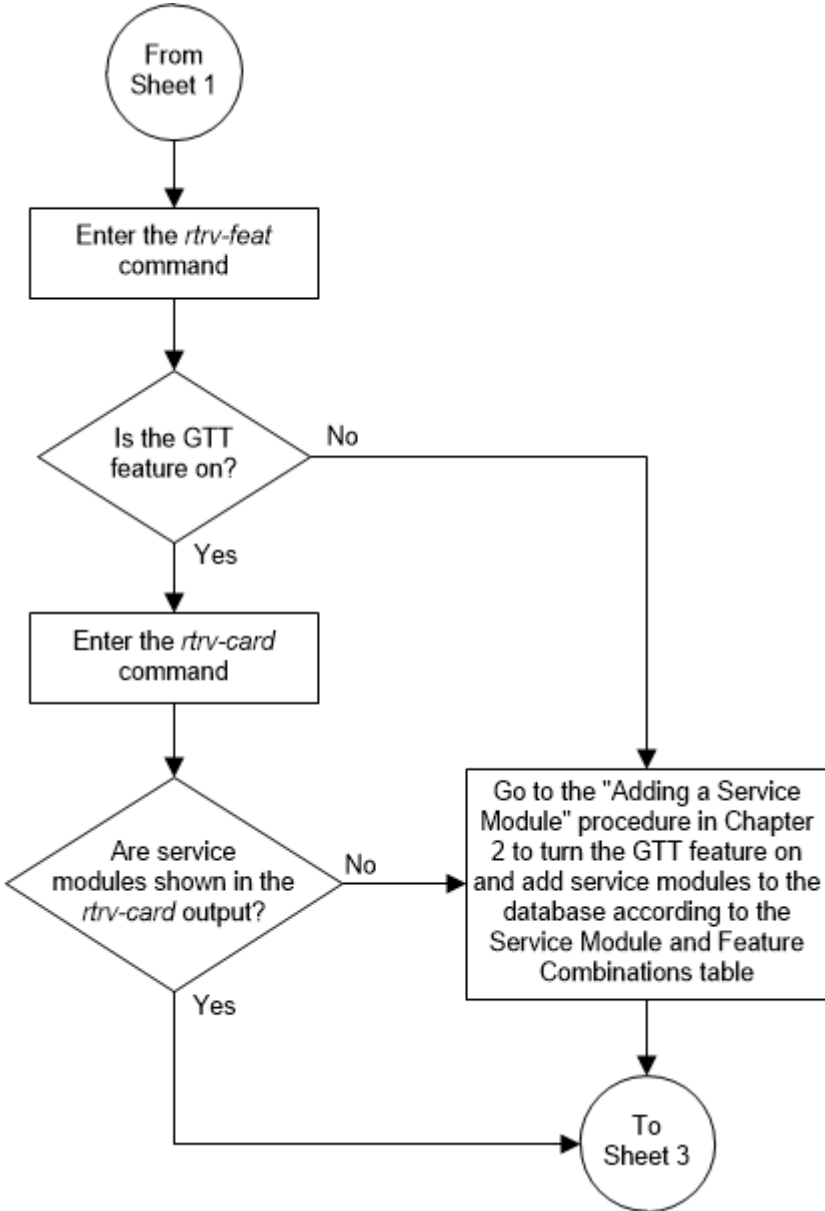

Figure 5-43 Activate the SCCP Loop Detection Feature - Sheet 3 of 5

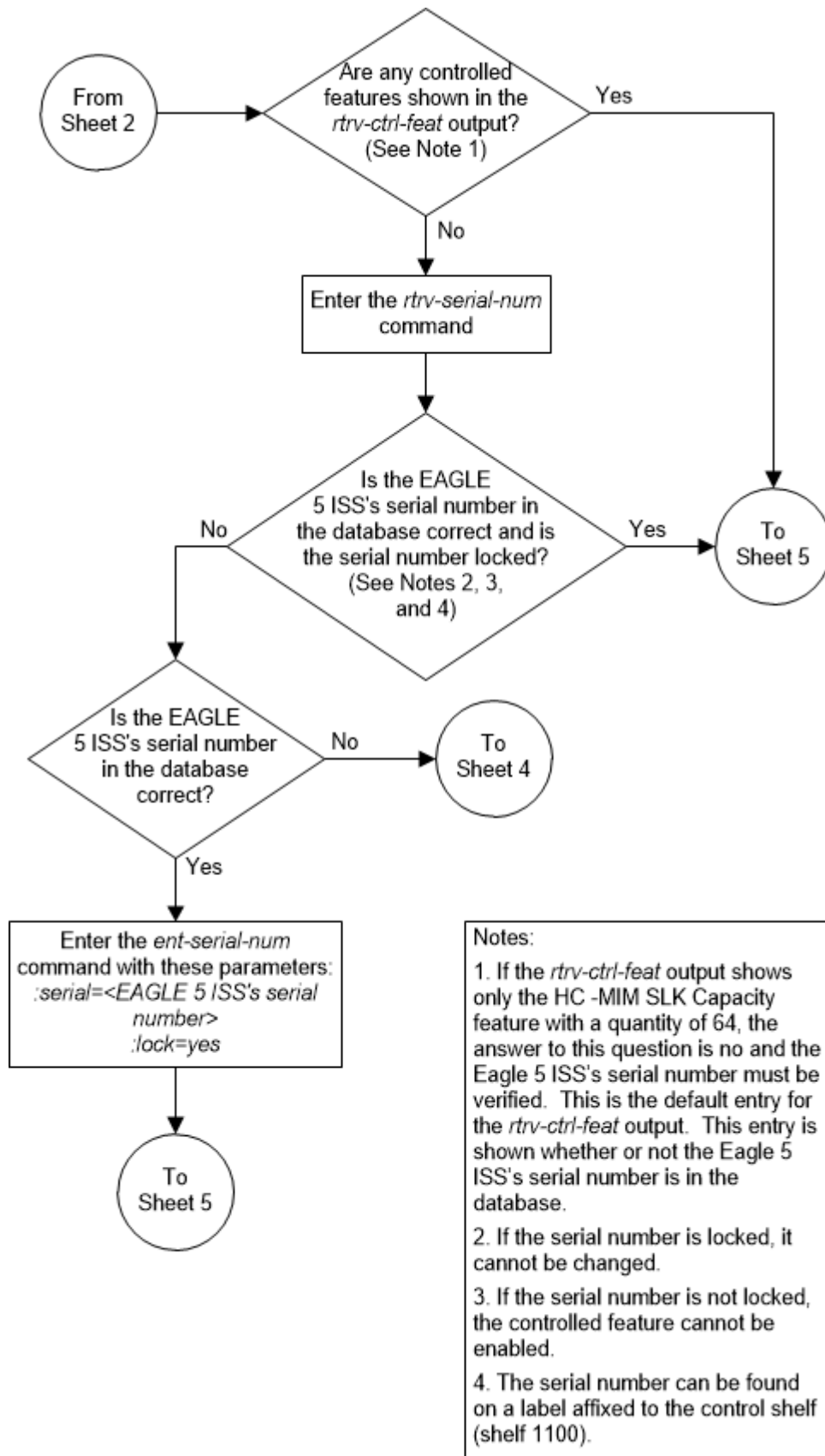

Figure 5-44 Activate the SCCP Loop Detection Feature - Sheet 4 of 5

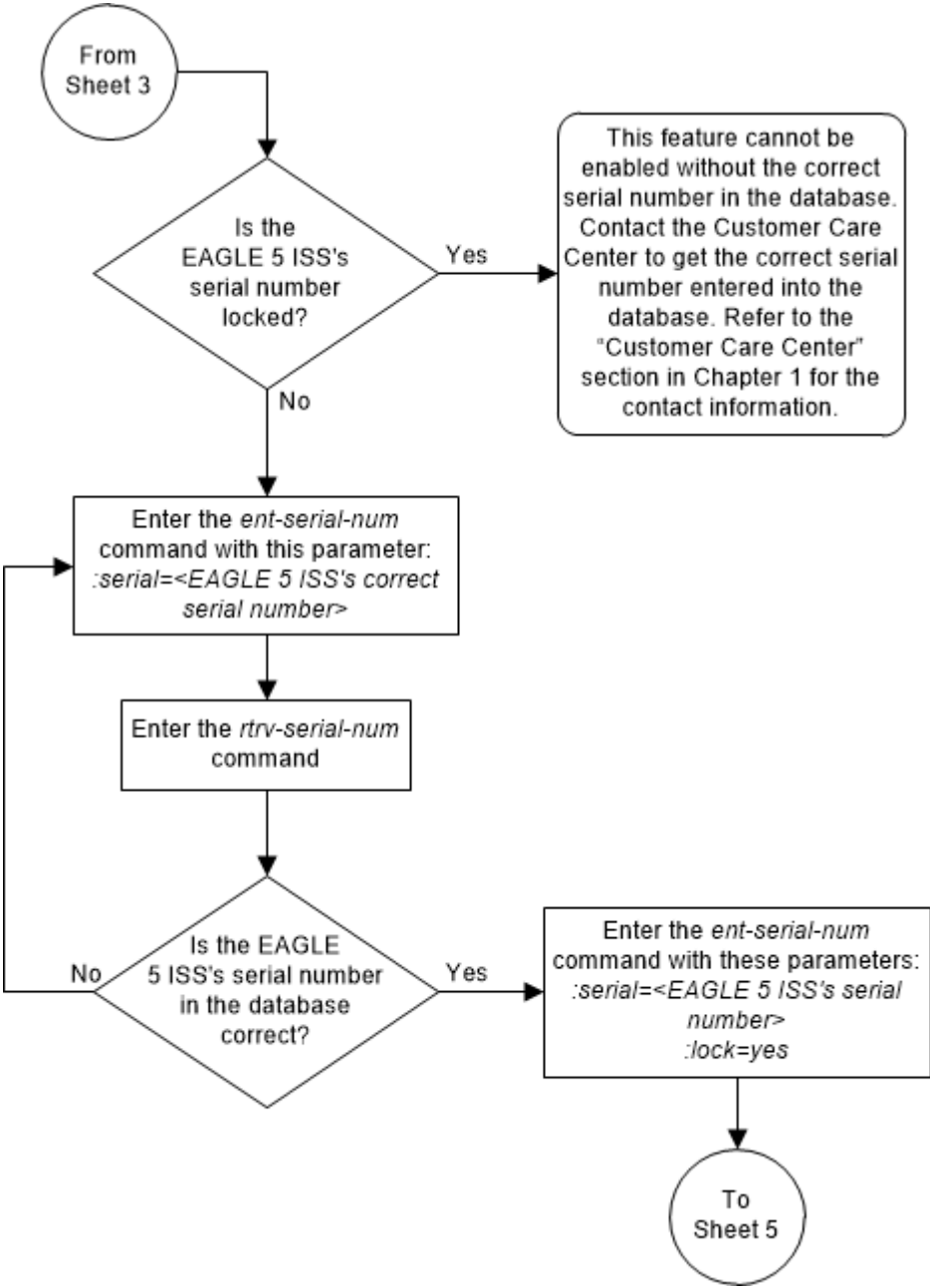
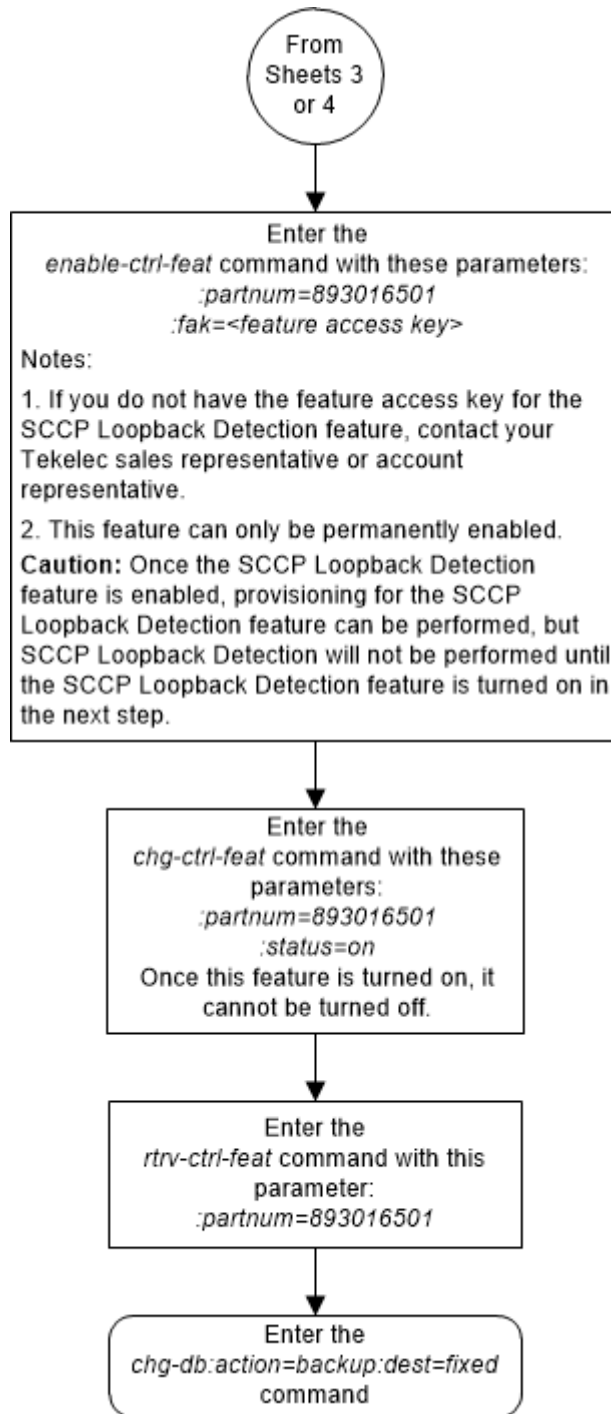

Figure 5-45 Activate the SCCP Loop Detection Feature - Sheet 5 of 5



Activating the Throughput Capacity Feature

This procedure is used to enable a quantity of SCCP transactions per second for the Throughput Capacity feature on E5-SM8G-B/SLIC hardware using the quantity's part number and a feature access key.

The feature access key is based on the feature's part number and the serial number of the EAGLE, making the feature access key site-specific.

The `enable-ctrl-feat` command enables the Throughput Capacity feature on E5-SM8G-B/SLIC hardware by inputting the feature's access key and the feature's part number with these parameters:

`:fak` – The feature access key provided. The feature access key contains 13 alphanumeric characters and is not case sensitive.

`:partnum` – The issued part number of the quantity of SCCP transactions per seconds that is being enabled. These are the quantities that can be enabled and their part numbers.

- 893019101 - 5000 SCCP transactions per second
- 893019102 - 6800 SCCP transactions per second
- 893019103 - 10000 SCCP transactions per second
- 893019104 - 13600 SCCP transactions per second

A temporary feature access key cannot be used to enable a quantity of SCCP transactions per second.

The GTT feature must be turned on to enable a quantity of SCCP transactions per second

The status of the GTT feature is shown in the `rtrv-feat` command output.

The `enable-ctrl-feat` command requires that the database contain a valid serial number for the EAGLE, and that this serial number is locked. This can be verified with the `rtrv-serial-num` command. The EAGLE is shipped with a serial number in the database, but the serial number is not locked. The serial number can be changed, if necessary, and locked once the EAGLE is on-site, with the `ent-serial-num` command. The `ent-serial-num` command uses these parameters.

`:serial` – The serial number assigned to the EAGLE. The serial number is not case sensitive.

`:lock` – Specifies whether or not the serial number is locked. This parameter has only one value, `yes`, which locks the serial number. Once the serial number is locked, it cannot be changed.

 **Note:**

To enter and lock the EAGLE serial number, the `ent-serial-num` command must be entered twice, once to add the correct serial number to the database with the `serial` parameter, then again with the `serial` and the `lock=yes` parameters to lock the serial number. You should verify that the serial number in the database is correct before locking the serial number. The serial number can be found on a label affixed to the control shelf (shelf 1100).

The status of the features in the **EAGLE** is shown with the `rtrv-ctrl-feat` command.

Table 2-35 in the [Adding a Service Module](#) procedure shows the maximum system transactions per second capacities that can be achieved when the Throughput Capacity feature on E5-SM8G-B/SLIC hardware is enabled with a quantity of 5000, 6800, 10,000, and 13,600 SCCP transactions per second.

1. Display the status of the Throughput Capacity feature by entering the `rtrv-ctrl-feat` command. This is an example of the possible output.

```
rlghncxa03w 09-07-28 21:15:37 GMT EAGLE5 41.1.0
The following features have been permanently enabled:
```

Feature Name	Partnum	Status	Quantity
Command Class Management	893005801	on	----
Intermed GTT Load Sharing	893006901	off	----
XGTT Table Expansion	893006101	off	----
XMAP Table Expansion	893007710	on	3000
Large System # Links	893005910	on	2000
Routesets	893006401	on	6000
HC-MIM SLK Capacity	893012707	on	64

The following features have been temporarily enabled:

Feature Name	Partnum	Status	Quantity	Trial
Period Left				
Zero entries found.				

The following features have expired temporary keys:

Feature Name	Partnum
Zero entries found.	

The Throughput Capacity feature on E5-SM8G-B/SLIC can be enabled for a quantity of 5000 SCCP transactions per second or 6800 SCCP transactions per second.

 **Note:**

If the 5000 SCCP transactions per second quantity is enabled, and an EPAP-based feature is enabled, the number of SCCP transactions per second is limited to 3125..

If the Throughput Capacity feature is enabled 6800 SCCP transactions per second, shown by the entry `E5-SM4G Throughput Cap` with the value 6800 in the Quantity column, no further action is necessary. This is the maximum number of SCCP transactions per second that can be enabled.

If the quantity for the Throughput Capacity feature is 5000 SCCP transactions per second, and you wish to enable the 6800 SCCP transactions per second quantity, continue the procedure with 8. If you do not wish to enable the 6800 SCCP transactions per second quantity, then the remainder of this procedure cannot be performed.

If neither the quantities of 5000 or 6800 SCCP transactions per second are shown in the `Quantity` column of the `rtrv-ctrl-feat` output, continue the procedure with [2](#).

- To enable the Throughput Capacity feature, the GTT feature must be turned on. The GTT feature is shown by the entry `GTT` in the `rtrv-feat` output.

Enter the `rtrv-feat` command to verify whether or not the GTT feature is on.

If the GTT feature is turned on, continue the procedure with [3](#).

If the GTT feature is turned off, perform [Adding a Service Module](#) to turn the GTT feature on and to add the required number of cards to the database. After [Adding a Service Module](#) has been performed, continue the procedure with [4](#).

- Verify the number of cards that are provisioned in the database using the `rept-stat-gpl:gpl=sccphc` command. This is an example of the possible output.

```
rlghncxa03w 09-07-01 11:40:26 GMT EAGLE5 41.1.0
GPL      CARD      RUNNING      APPROVED      TRIAL
SCCPHC  1201    126-002-000  126-002-000  126-003-000
SCCPHC  1203    126-002-000  126-002-000  126-003-000
SCCPHC  1207    126-002-000  126-002-000  126-003-000
SCCPHC  1213    126-002-000  126-002-000  126-003-000
SCCPHC  1215    126-002-000  126-002-000  126-003-000
SCCPHC  1305    126-002-000  126-002-000  126-003-000
SCCPHC  1313    126-002-000  126-002-000  126-003-000
SCCPHC  2103    126-002-000  126-002-000  126-003-000
Command Completed
```

If the required number of cards are provisioned in the database, continue the procedure with [4](#).

If the required number of cards are not provisioned in the database, perform [Adding a Service Module](#) to add the required number of cards to the database. After [Adding a Service Module](#) has been performed, continue the procedure with [4](#).

- Display the serial number in the database with the `rtrv-serial-num` command. This is an example of the possible output.

Note:

If the `rtrv-ctrl-feat` output in [1](#) shows any controlled features, continue the procedure with [8](#). If the `rtrv-ctrl-feat` output shows only the HC-MIM SLK Capacity feature with a quantity of 64, [4](#) through [7](#) must be performed.

```
rlghncxa03w 09-07-28 21:15:37 GMT EAGLE5 41.1.0
System serial number = nt00001231
```

System serial number is not locked.

```
rlghncxa03w 09-07-28 21:15:37 GMT EAGLE5 41.1.0
Command Completed
```

 **Note:**

If the serial number is correct and locked, continue the procedure with 8. If the serial number is correct but not locked, continue the procedure with 7. If the serial number is not correct, but is locked, this feature cannot be enabled and the remainder of this procedure cannot be performed. Contact the Customer Care Center to get an incorrect and locked serial number changed. Refer to [#unique_17](#) for the contact information. The serial number can be found on a label affixed to the control shelf (shelf 1100).

5. Enter the correct serial number into the database using the `ent-serial-num` command with the `serial` parameter.

For this example, enter this command.

```
ent-serial-num:serial=<EAGLE's correct serial number>
```

When this command has successfully completed, this message should appear.

```
rlghncxa03w 07-07-28 21:15:37 GMT EAGLE5 41.1.0  
ENT-SERIAL-NUM: MASP A - COMPLTD
```

6. Verify that the serial number entered into was entered correctly using the `rtrv-serial-num` command. This is an example of the possible output.

```
rlghncxa03w 09-07-28 21:15:37 GMT EAGLE5 41.1.0  
System serial number = nt00001231
```

System serial number is not locked.

```
rlghncxa03w 09-07-28 21:15:37 GMT EAGLE5 41.1.0  
Command Completed
```

If the serial number was not entered correctly, repeat and re-enter the correct serial number.

7. Lock the serial number in the database by entering the `ent-serial-num` command with the serial number shown in , if the serial number shown in is correct, or with the serial number shown in , if the serial number was changed in , and with the `lock=yes` parameter.

For this example, enter this command.

```
ent-serial-num:serial=<EAGLE's serial number>:lock=yes
```

When this command has successfully completed, this message should appear.

```
rlghncxa03w 09-07-28 21:15:37 GMT EAGLE5 41.1.0  
ENT-SERIAL-NUM: MASP A - COMPLTD
```

8. Enable the E5-SM4G Throughput Capacity feature for a quantity of 5000 or 6800 SCCP transactions per second by entering the `enable-ctrl-feat` command with the part number of the quantity.

These are the part numbers that can be used in this procedure.

- 893019101 - 5000 SCCP transactions per second
- 893019102 - 6800 SCCP transactions per second
- 893019103 - 10000 SCCP transactions per second
- 893019104 - 13600 SCCP transactions per second

To enable the Throughput Capacity feature for a quantity of 5000 SCCP transactions per second, enter this command.

```
enable-ctrl-feat:partnum=893019101:fak=<feature access key  
for 5000 SCCP transactions per second>
```

 **Note:**

If the 5000 SCCP transactions per second quantity is enabled, and an EPAP-based feature is enabled, the number of SCCP transactions per second is limited to 3125..

To enable the E5-SM4G Throughput Capacity feature for a quantity of 6800 SCCP transactions per second, enter this command.

```
enable-ctrl-feat:partnum=893019102:fak=<feature access key  
for 6800 SCCP transactions per second>
```

```
enable-ctrl-feat:partnum=893019103:fak=<feature access key  
for 10000 SCCP transactions per second>
```

```
enable-ctrl-feat:partnum=893019104:fak=<feature access key  
for 13600 SCCP transactions per second>
```

 **Note:**

The Throughput Capacity feature cannot be enabled with a temporary feature access key.

 **Note:**

The value for the feature access key (the *fak* parameter) is provided by Oracle. If you do not have the feature access key for the SCCP transactions per second quantity, contact your Oracle Sales Representative or Account Representative.

When the `enable-ctrl-feat` command has successfully completed, this message should appear.

```
rlghncxa03w 09-07-28 21:15:37 GMT EAGLE5 41.1.0  
ENABLE-CTRL-FEAT: MASP B - COMPLTD
```

9. Verify the changes by entering the `rtrv-ctrl-feat` command with the E5-SM4G Throughput Capacity feature part number specified in .

If the quantity of 5000 SCCP transactions per second was enabled and turned on, enter this command.

```
rtrv-ctrl-feat:partnum=893019101
```

This is an example of the possible output.

```
rlghncxa03w 09-07-28 21:15:37 GMT EAGLE5 41.1.0
```

The following features have been permanently enabled:

Feature Name	Partnum	Status	Quantity
E5-SM4G Throughput Cap	893019101	on	5000

The following features have been temporarily enabled:

Feature Name	Partnum	Status	Quantity	Trial
Period Left				

Zero entries found.

The following features have expired temporary keys:

Feature Name	Partnum
Zero entries found.	

If the quantity of 6800 SCCP transactions per second was enabled and turned on, enter this command.

```
rtrv-ctrl-feat:partnum=893019102
```

This is an example of the possible output.

```
rlghncxa03w 09-07-28 21:15:37 GMT EAGLE5 41.1.0
```

The following features have been permanently enabled:

Feature Name	Partnum	Status	Quantity
E5-SM4G Throughput Cap	893019102	on	6800

The following features have been temporarily enabled:

Feature Name	Partnum	Status	Quantity	Trial
Period Left				

Zero entries found.

The following features have expired temporary keys:

Feature Name	Partnum
Zero entries found.	

If the quantity of 10000 SCCP transactions per second was enabled and turned on, enter this command.

```
rtrv-ctrl-feat:partnum=893019103
```

This is an example of the possible output.

```
rlghncxa03w 09-07-28 21:15:37 GMT EAGLE5 41.1.0
The following features have been permanently enabled:
```

Feature Name	Partnum	Status	Quantity
E5-SM4G Throughput Cap	893019103	on	10000

The following features have been temporarily enabled:

Feature Name	Partnum	Status	Quantity	Trial
Period Left				
Zero entries found.				

The following features have expired temporary keys:

Feature Name	Partnum
Zero entries found.	

If the quantity of 13600 SCCP transactions per second was enabled and turned on, enter this command.

```
rtrv-ctrl-feat:partnum=893019104
```

This is an example of the possible output.

```
rlghncxa03w 08-07-13 21:15:37 GMT EAGLE5 45.0.0
The following features have been permanently enabled:
```

Feature Name	Partnum	Status	Quantity
E5-SM8G Throughput Cap	893019104	on	13600

The following features have been temporarily enabled:

Feature Name	Partnum	Status	Quantity	Trial
Period Left				
Zero entries found.				

The following features have expired temporary keys:

Feature Name	Partnum
Zero entries found.	

- Backup the new changes using the `chg-db:action=backup:dest=fixed` command. These messages should appear, the active Maintenance and Administration Subsystem Processor (MASP) appears first.

```
BACKUP (FIXED) : MASP A - Backup starts on active MASP.
BACKUP (FIXED) : MASP A - Backup on active MASP to fixed disk
complete.
BACKUP (FIXED) : MASP A - Backup starts on standby MASP.
BACKUP (FIXED) : MASP A - Backup on standby MASP to fixed disk
complete.
```

Figure 5-46 Activate the Throughput Capacity Feature - Sheet 1 of 3

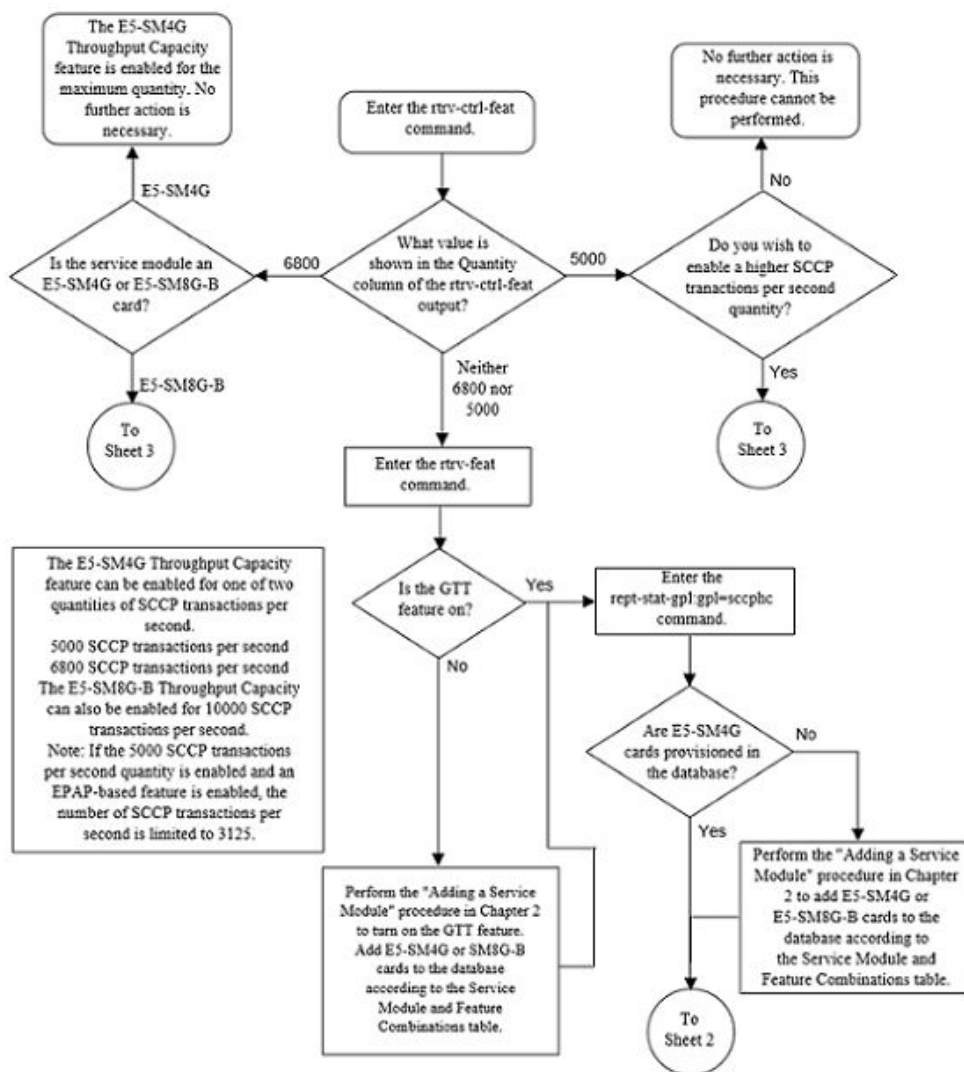

Figure 5-47 Activate the Throughput Capacity Feature - Sheet 2 of 3

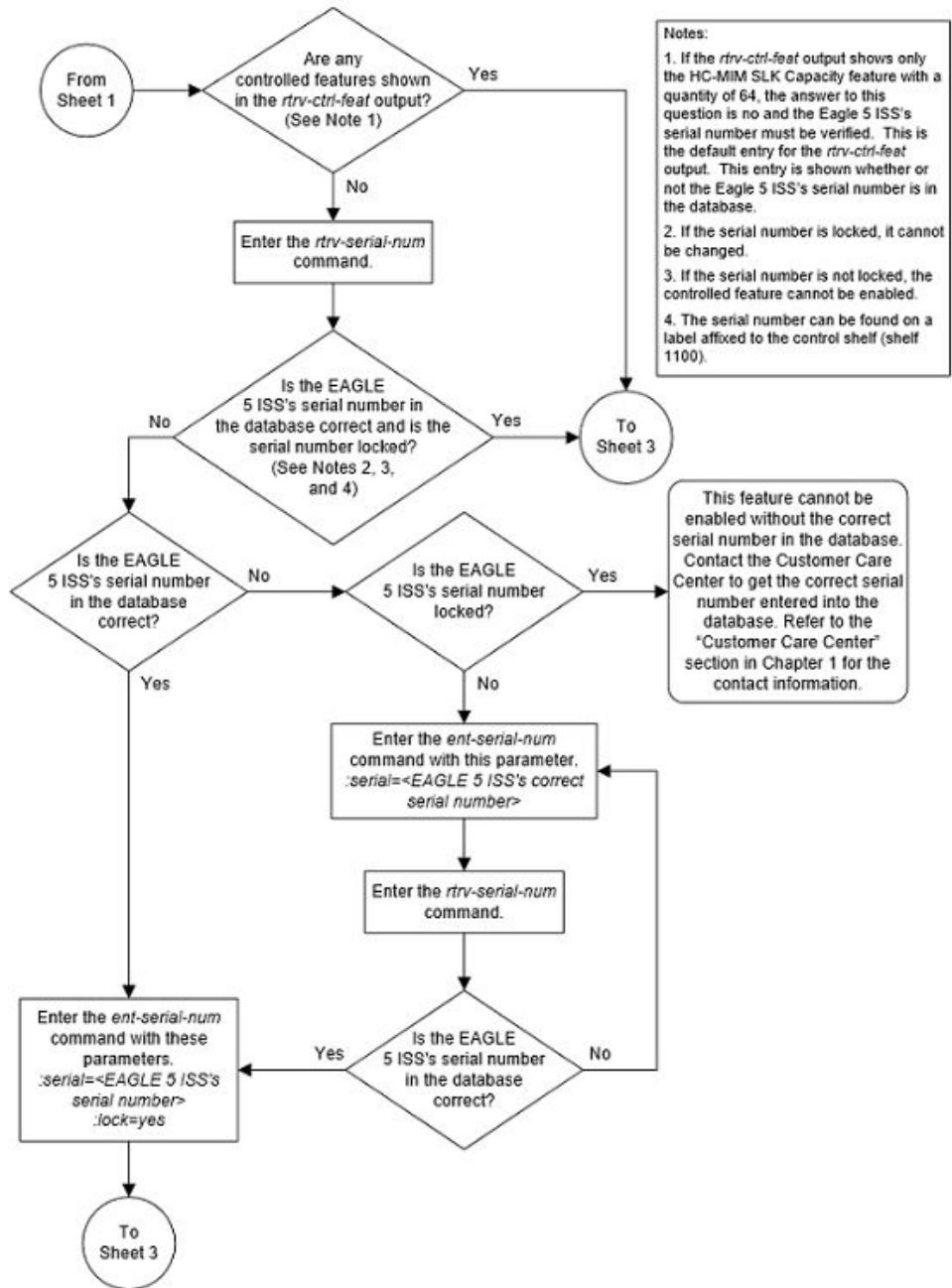
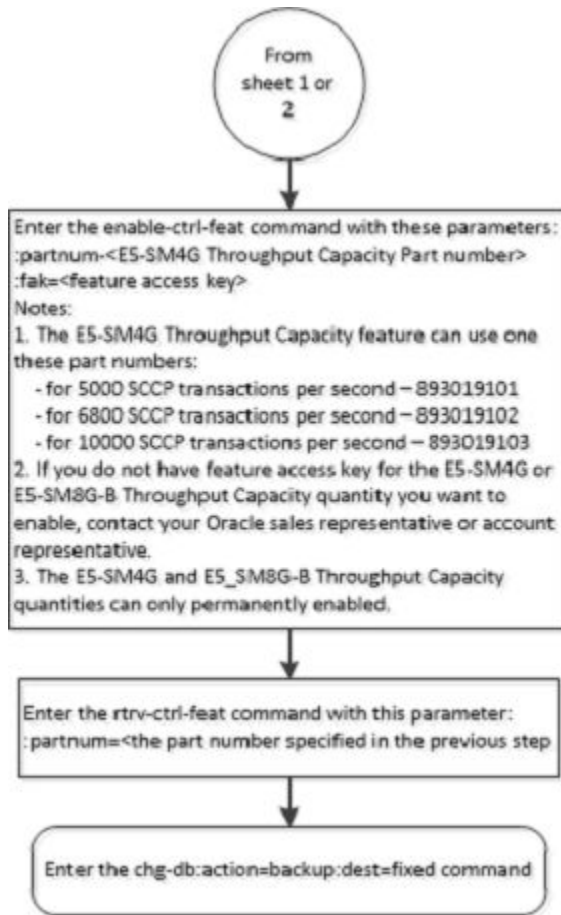

Figure 5-48 Activate the Throughput Capacity Feature - Sheet 3 of 3



Activating the Advanced GT Modification Feature

This procedure is used to enable and turn on the Advanced GT Modification feature using the feature's part number and a feature access key.

The feature access key for the Advanced GT Modification feature is based on the feature's part number and the serial number of the EAGLE, making the feature access key site-specific.

The `enable-ctrl-feat` command enables the feature by inputting the feature's access key and the feature's part number with these parameters:

`:fak` – The feature access key provided. The feature access key contains 13 alphanumeric characters and is not case sensitive.

`:partnum` – The issued part number of the Advanced GT Modification feature. There are three part numbers associated with the Advanced GT Modification feature.

- 893021801 - AMGTT - provides GT modification to both the called party address and the calling party address of SCCP messages. This part number can be specified only if no Advanced GT Modification feature is currently enabled.
- 893021802 - AMGTT CdPA Only - provides GT modification to the called party address of SCCP messages only. This feature and its part number is shown in

the `rtrv-ctrl-feat` output only if the MGTT feature from previous releases was turned on when the EAGLE was upgraded to the release containing the Advanced GT Modification feature. This part number cannot be specified with the `enable-ctrl-feat` command.

- 893021803 - AMGTT CgPA Upgrade - provides GT modification to the calling party address and called party address of SCCP messages. This part number can be specified only if the AMGTT CdPA Only feature (part number 893021802) is enabled.

For more information on the Advanced GT Modification feature, refer to the [Advanced GT Modification Feature](#) section.

The `enable-ctrl-feat` command requires that the database contain a valid serial number for the EAGLE, and that this serial number is locked. This can be verified with the `rtrv-serial-num` command. The EAGLE is shipped with a serial number in the database, but the serial number is not locked. The serial number can be changed, if necessary, and locked once the EAGLE is on-site, with the `ent-serial-num` command. The `ent-serial-num` command uses these parameters.

`:serial` – The serial number assigned to the EAGLE. The serial number is not case sensitive.

`:lock` – Specifies whether or not the serial number is locked. This parameter has only one value, `yes`, which locks the serial number. Once the serial number is locked, it cannot be changed.

 **Note:**

To enter and lock the EAGLE's serial number, the `ent-serial-num` command must be entered twice, once to add the correct serial number to the database with the `serial` parameter, then again with the `serial` and the `lock=yes` parameters to lock the serial number. You should verify that the serial number in the database is correct before locking the serial number. The serial number can be found on a label affixed to the control shelf (shelf 1100).

These features cannot be temporarily enabled (with the temporary feature access key).

Once any of these features are enabled, they are also activated. The `chg-ctrl-feat` command cannot be used to turn these features on. Once any of these features are enabled, they cannot be turned off.

The status of the Advanced GT Modification features is shown in the `rtrv-ctrl-feat` command output.

Before the Advanced GT Modification feature can be enabled, the GTT feature must be turned on. The state of the GTT feature can be verified using the `rtrv-feat` command.

1. Display the status of the Advanced GT Modification feature by entering the `rtrv-ctrl-feat` command.

The following is an example of the possible output.

```
rlghncxa03w 06-10-28 21:15:37 GMT EAGLE5 38.0.0
```

The following features have been permanently enabled:

Feature Name	Partnum	Status	Quantity
Command Class Management	893005801	on	----
LNP Short Message Service	893006601	on	----
Intermed GTT Load Sharing	893006901	on	----
HC-MIM SLK Capacity	893012707	on	64

The following features have been temporarily enabled:

Feature Name	Partnum	Status	Quantity	Trial Period Left
Zero entries found.				

The following features have expired temporary keys:

Feature Name	Partnum
Zero entries found.	

If the AMGTT or AMGTT CgPA Upgrade feature is enabled, no further action is necessary. This procedure does not need to be performed.

If the AMGTT CdPA Only feature is enabled, and you do not wish to enable the AMGTT CgPA Upgrade feature, no further action is necessary.

If the AMGTT CdPA Only feature is enabled, and you wish to enable the AMGTT CgPA Upgrade feature, continue the procedure with [8](#).

If none of the Advanced GT Modification features are enabled, continue the procedure with [2](#).

2. Verify the GTT feature is on, by entering the `rtrv-feat` command. If the GTT feature is on, the GTT field should be set to `on`.

 **Note:**

The `rtrv-feat` command output contains other fields that are not used by this procedure. If you wish to see all the fields displayed by the `rtrv-feat` command, see the `rtrv-feat` command description in *Commands User's Guide*.

If the GTT feature is not on, perform [Adding a Service Module](#) to turn the GTT feature on and add the appropriate service modules to the EAGLE. After the GTT feature is turned on and the service modules have been added, continue the procedure with [4](#).

If the GTT feature is on, continue the procedure with [3](#).

3. Display the cards in the EAGLE using the `rtrv-card` command. The Advanced GT Modification feature requires that service modules are in the database. This is an example of the possible output.

```
rlghncxa03w 09-05-25 09:58:31 GMT EAGLE5 41.0.0
CARD   TYPE      APPL      LSET NAME      PORT SLC LSET NAME
PORT SLC
1102   TSM          GLS
1113   E5MCAP       OAMHC
1114   E5TDM-A
1115   E5MCAP       OAMHC
1116   E5TDM-B
1117   E5MDAL
1201   LIMDS0       SS7ANSI   sp2            A    0    sp1
B      0
1203   LIMDS0       SS7ANSI   sp3            A    0
1204   LIMDS0       SS7ANSI   sp3            A    1
1206   LIMDS0       SS7ANSI   nsp3           A    1    nsp4
B      1
1308   LIMDS0       SS7ANSI   sp6            A    1    sp7
B      0
1314   LIMDS0       SS7ANSI   sp7            A    1    sp5
B      1
```

There are two types of service modules, SMs or E5-SM4Gs running the VSCCP application.

SMs and E5-SM4Gs are shown by the entries `DSM` in the `TYPE` column and `VSCCP` in the `APPL` column.

If no service modules are shown in the `rtrv-card` output, perform [Adding a Service Module](#) to add the appropriate service modules to the EAGLE. After the service modules have been added, continue the procedure with [4](#).

If service modules are in the EAGLE, continue the procedure with [4](#).

4. Display the serial number in the database with the `rtrv-serial-num` command.

 **Note:**

If the `rtrv-ctrl-feat` output in [1](#) shows any controlled features, continue the procedure with [8](#). If the `rtrv-ctrl-feat` output shows only the HC-MIM SLK Capacity feature with a quantity of 64, [4](#) through [7](#) must be performed.

This is an example of the possible output.

```
rlghncxa03w 06-10-28 21:15:37 GMT EAGLE5 38.0.0
System serial number = nt00001231
```

System serial number is not locked.

```
rlghncxa03w 06-10-28 21:15:37 GMT EAGLE5 38.0.0  
Command Completed.
```

5. Enter the correct serial number into the database using the `ent-serial-num` command with the `serial` parameter.

 **Note:**

If the serial number is correct and locked, continue the procedure with 8. If the serial number is correct but not locked, continue the procedure with 7. If the serial number is not correct, but is locked, this feature cannot be enabled and the remainder of this procedure cannot be performed. Contact the Customer Care Center to get an incorrect and locked serial number changed. Refer to [#unique_17](#) for the contact information. The serial number can be found on a label affixed to the control shelf (shelf 1100).

For this example, enter this command.

```
ent-serial-num:serial=<EAGLE's correct serial number>
```

When this command has successfully completed, the following message should appear.

```
rlghncxa03w 06-10-28 21:15:37 GMT EAGLE5 38.0.0  
ENT-SERIAL-NUM: MASP A - COMPLTD
```

6. Verify that the serial number entered in was entered correctly using the `rtrv-serial-num` command.

This is an example of the possible output.

```
rlghncxa03w 06-10-28 21:15:37 GMT EAGLE5 38.0.0  
System serial number = nt00001231
```

```
System serial number is not locked.
```

```
rlghncxa03w 06-10-28 21:15:37 GMT EAGLE5 38.0.0  
Command Completed.
```

If the serial number was not entered correctly, repeat and re-enter the correct serial number.

7. Lock the serial number in the database by entering the `ent-serial-num` command with the serial number shown in , if the serial number shown in is correct, or with the serial number shown in , if the serial number was changed in , and with the `lock=yes` parameter.

For this example, enter this command.

```
ent-serial-num:serial=<EAGLE's serial number>:lock=yes
```

When this command has successfully completed, the following message should appear.

```
rlghncxa03w 06-10-28 21:15:37 GMT EAGLE5 38.0.0  
ENT-SERIAL-NUM: MASP A - COMPLTD
```

8. Enable the Advanced GT Modification feature with the `enable-ctrl-feat` command specifying the part number for the Advanced GT Modification feature and the feature access key.

If the AMGTT feature is being enabled, enter this command.

```
enable-ctrl-feat:partnum=893021801:fak=<AMGTT feature access  
key>
```

If the AMGTT CgPA Upgrade feature is being enabled, enter this command.

```
enable-ctrl-feat:partnum=893021803:fak=<AMGTT CgPA Upgrade  
feature access key>
```

 **Note:**

Neither the AMGTT nor the AMGTT CgPA Upgrade feature can be enabled with a temporary feature access key.

 **Note:**

The values for the feature access key (the `fak` parameter) are provided. If you do not have the feature access key for the AMGTT or the AMGTT CgPA Upgrade feature, contact your Sales Representative or Account Representative.

When the `enable-ctrl-feat` command has successfully completed, this message should appear.

```
rlghncxa03w 06-10-28 21:15:37 GMT EAGLE5 38.0.0  
ENABLE-CTRL-FEAT: MASP B - COMPLTD
```

9. Verify the changes by entering the `rtrv-ctrl-feat` command with the part number used in .

If the AMGTT feature was enabled in , enter this command.

```
rtrv-ctrl-feat:partnum=893021801
```

The following is an example of the possible output.

```
rlghncxa03w 06-10-28 21:15:37 GMT EAGLE5 38.0.0  
The following features have been permanently enabled:
```

Feature Name	Partnum	Status	Quantity
AMGTT	893021801	on	----

The following features have been temporarily enabled:

```
Feature Name          Partnum    Status  Quantity  Trial
Period Left
Zero entries found.
```

The following features have expired temporary keys:

```
Feature Name          Partnum
Zero entries found.
```

If the AMGTT CgPA Upgrade feature was enabled in , enter this command.

```
rtrv-ctrl-feat:partnum=893021803
```

The following is an example of the possible output.

```
rlghncxa03w 06-10-28 21:15:37 GMT EAGLE5 38.0.0
```

The following features have been permanently enabled:

```
Feature Name          Partnum    Status  Quantity
AMGTT CgPA Upgrade    893021803  on      ----
```

The following features have been temporarily enabled:

```
Feature Name          Partnum    Status  Quantity  Trial
Period Left
Zero entries found.
```

The following features have expired temporary keys:

```
Feature Name          Partnum
Zero entries found.
```

10. Backup the new changes using the `chg-db:action=backup:dest=fixed` command.

These messages should appear, the active Maintenance and Administration Subsystem Processor (MASP) appears first.

```
BACKUP (FIXED) : MASP A - Backup starts on active MASP.
BACKUP (FIXED) : MASP A - Backup on active MASP to fixed disk
complete.
BACKUP (FIXED) : MASP A - Backup starts on standby MASP.
BACKUP (FIXED) : MASP A - Backup on standby MASP to fixed disk
complete.
```

Figure 5-49 Activate the Advanced GT Modification Feature - Sheet 1 of 3

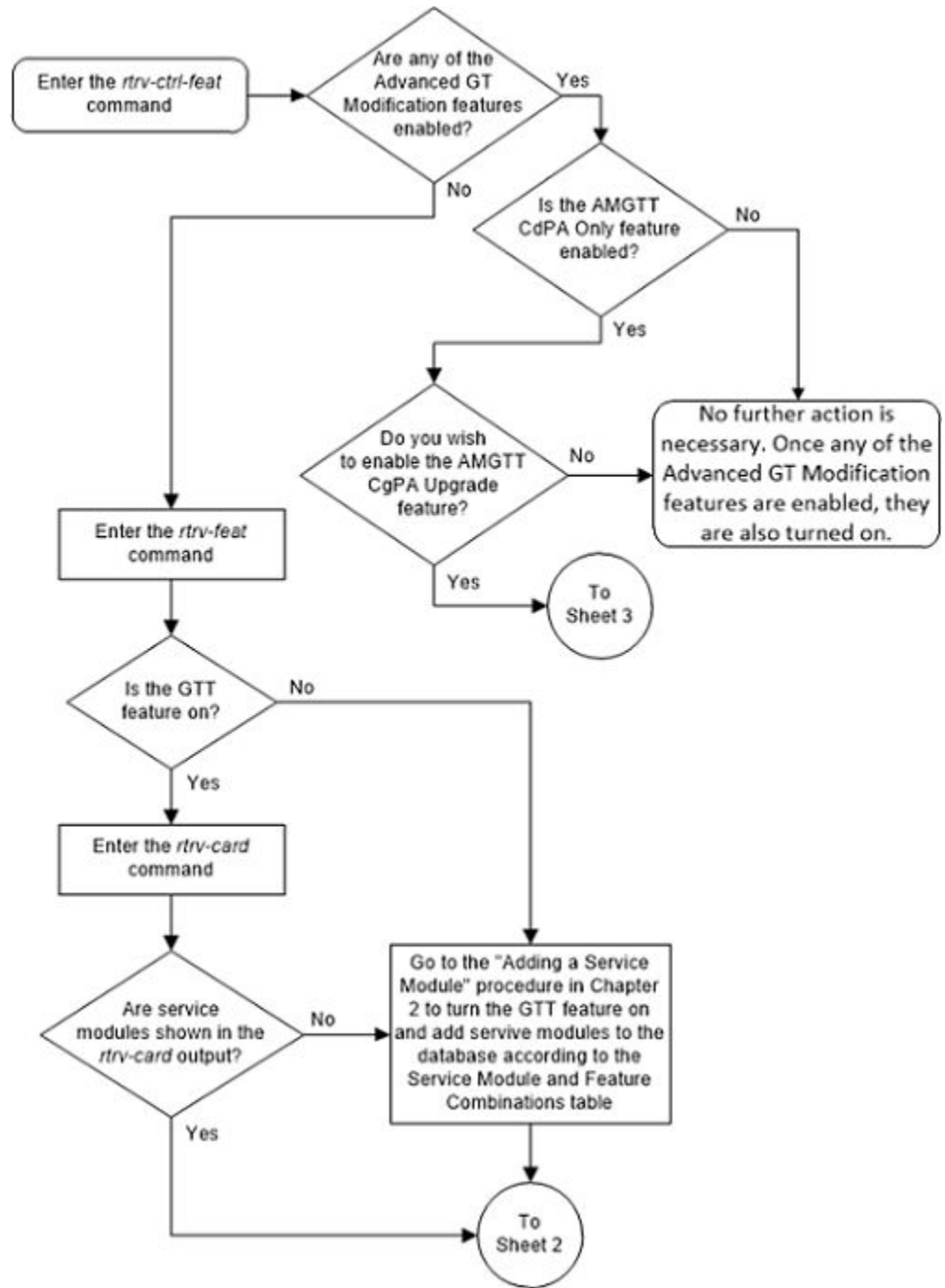

Figure 5-50 Activate the Advanced GT Modification Feature - Sheet 2 of 3

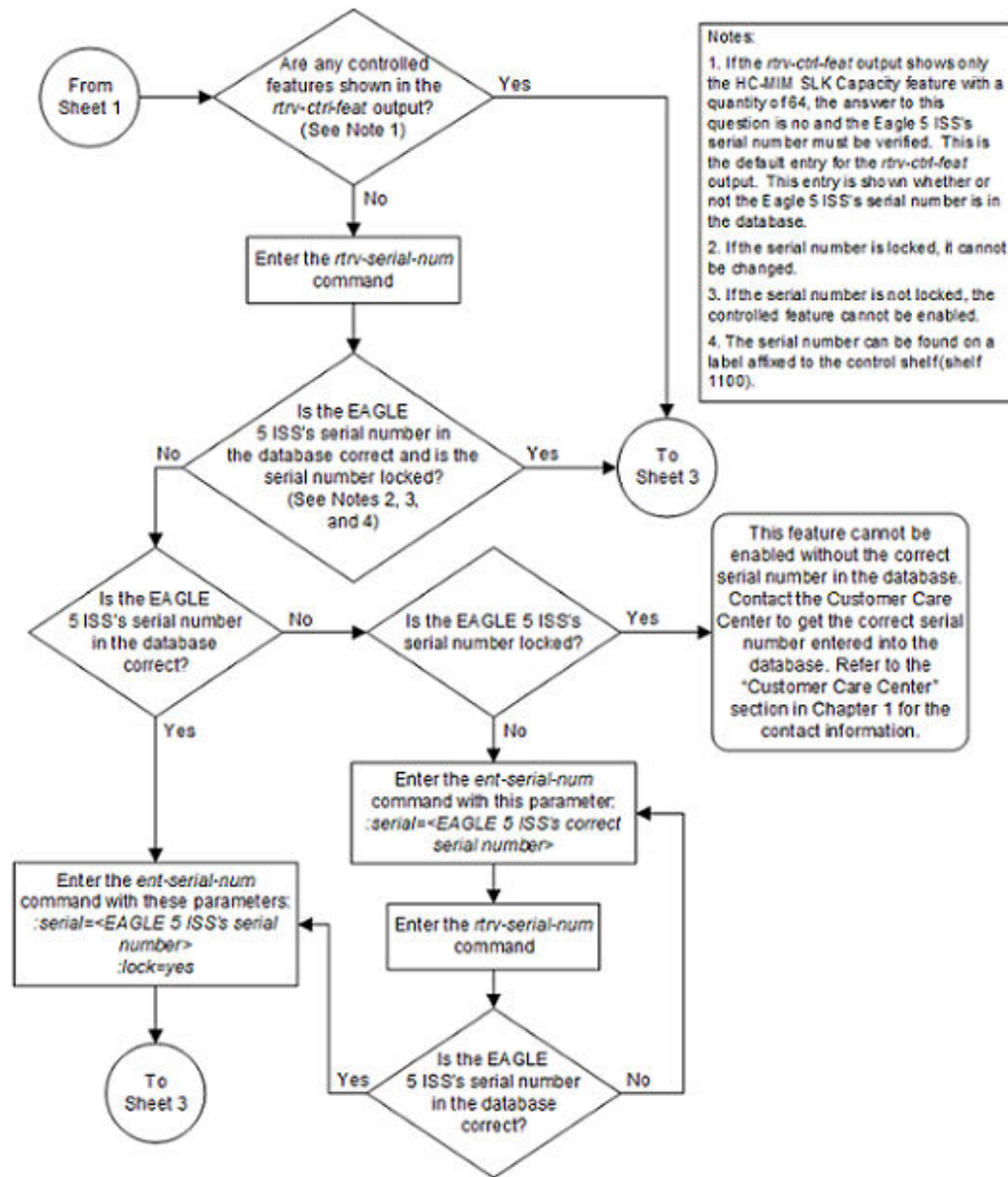
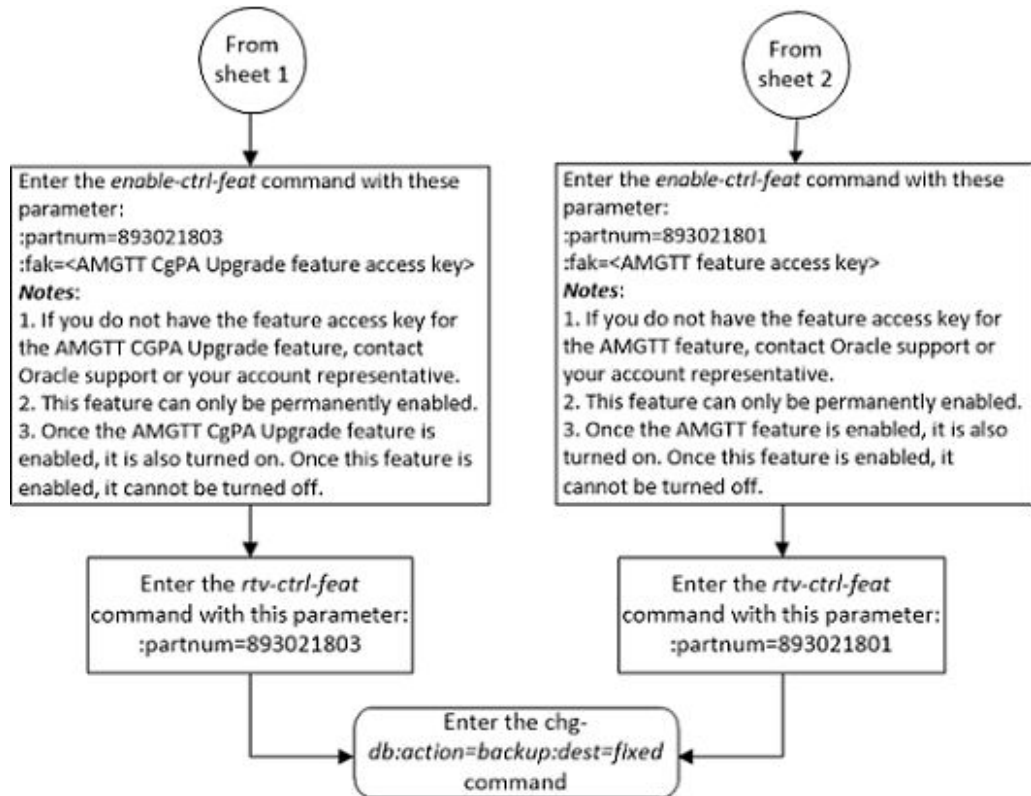

Figure 5-51 Activate the Advanced GT Modification Feature - Sheet 3 of 3



Activating the GTT Load Sharing with Alternate Routing Indicator Feature

This procedure is used to enable and turn on the GTT Load Sharing with Alternate Routing Indicator feature using the feature's part number and a feature access key.

The feature access key for the GTT Load Sharing with Alternate Routing Indicator feature is based on the feature's part number and the serial number of the EAGLE, making the feature access key site-specific.

The `enable-ctrl-feat` command enables the feature by inputting the feature's access key and the feature's part number with these parameters:

`:fak` – The feature access key generated by the feature access key generator. The feature access key contains 13 alphanumeric characters and is not case sensitive.

`:partnum` – The Oracle-issued part number of the GTT Load Sharing with Alternate Routing Indicator feature, 893027401.

To enable the GTT Load Sharing with Alternate Routing Indicator feature, the IGTTLS feature must be enabled and turned on, and the Flexible GTT Load Sharing feature must be enabled. Perform [Activating the IGTTLS feature](#) to enable and turn on the IGTTLS feature. Perform [Activating the Flexible GTT Load Sharing Feature](#) to enable the Flexible GTT Load Sharing feature.

The `enable-ctrl-feat` command requires that the database contain a valid serial number for the EAGLE, and that this serial number is locked. This can be verified with the `rtrv-serial-num` command. The EAGLE is shipped with a serial number in the database, but the serial number is not locked. The serial number can be changed, if necessary, and locked once the EAGLE is on-site, with the `ent-serial-num` command. The `ent-serial-num` command uses these parameters.

`:serial` – The serial number assigned to the EAGLE. The serial number is not case sensitive.

`:lock` – Specifies whether or not the serial number is locked. This parameter has only one value, `yes`, which locks the serial number. Once the serial number is locked, it cannot be changed.

 **Note:**

To enter and lock the EAGLE's serial number, the `ent-serial-num` command must be entered twice, once to add the correct serial number to the database with the `serial` parameter, then again with the `serial` and the `lock=yes` parameters to lock the serial number. You should verify that the serial number in the database is correct before locking the serial number. The serial number can be found on a label affixed to the control shelf (shelf 1100).

This feature cannot be temporarily enabled (with the temporary feature access key).

Once this feature is enabled, provisioning for this feature can be performed, but the feature will not work until the feature is turned on with the `chg-ctrl-feat` command. The `chg-ctrl-feat` command uses these parameters.

`:partnum` – The Oracle-issued part number of the GTT Load Sharing with Alternate Routing Indicator feature, 893027401.

`:status=on` – used to turn the GTT Load Sharing with Alternate Routing Indicator feature on.

Once the GTT Load Sharing with Alternate Routing Indicator feature has been turned on, it can be turned off. For more information on turning the GTT Load Sharing with Alternate Routing Indicator feature off, perform [Turning Off the GTT Load Sharing with Alternate Routing Indicator Feature](#).

The status of the features in the EAGLE is shown with the `rtrv-ctrl-feat` command.

When the GTT Load Sharing with Alternate Routing Indicator feature is turned on, loadsharing between MAP sets and MRN sets can be performed. This is done by allowing MRN sets to be provisioned in MAP sets, and MAP sets to be provisioned in MRN sets. When the search in the current set (MAP or MRN) is successful but all the destinations in that set are unavailable/prohibited, the extended search is performed in the other set (MRN or MAP) that is assigned to the current set. The extended search from the MAP set to the MRN set, or from the MRN set to the MAP set, is performed only once to prevent the endless searching of a loadsharing node.

1. Display the status of the controlled features by entering the `rtrv-ctrl-feat` command. The following is an example of the possible output.

```
rlghncxa03w 09-02-28 21:15:37 GMT EAGLE5 40.1.0  
The following features have been permanently enabled:
```

Feature Name	Partnum	Status	Quantity
Command Class Management	893005801	on	----
LNP Short Message Service	893006601	on	----
Intermed GTT Load Sharing	893006901	on	----
XGTT Table Expansion	893006101	on	400000
XMAP Table Expansion	893007710	off	----
Large System # Links	893005910	on	2000
Routesets	893006401	on	6000
HC-MIM SLK Capacity	893012707	on	64

The following features have been temporarily enabled:

Feature Name	Partnum	Status	Quantity	Trial Period Left
Zero entries found.				

The following features have expired temporary keys:

Feature Name	Partnum
Zero entries found.	

If the GTT Load Sharing with Alternate Routing Indicator feature is enabled and turned on, no further action is necessary. This procedure does not need to be performed.

If the GTT Load Sharing with Alternate Routing Indicator feature is enabled and but not turned on, continue the procedure with [8](#).

If the GTT Load Sharing with Alternate Routing Indicator feature is not enabled, continue the procedure by performing one of these steps.

- If the `rtrv-ctrl-feat` output shows the HC-MIMSLK Capacity feature with a quantity of 64 and other features, continue the procedure with [6](#).
- If the `rtrv-ctrl-feat` output shows only the HC-MIMSLK Capacity feature with a quantity of 64, continue the procedure with [2](#).

2. Display the serial number in the database with the `rtrv-serial-num` command. This is an example of the possible output.

```
rlghncxa03w 09-02-28 21:15:37 GMT EAGLE5 40.1.0  
System serial number = nt00001231
```

System serial number is not locked.

```
rlghncxa03w 09-02-28 21:15:37 GMT EAGLE5 40.1.0  
Command Completed.
```

 **Note:**

If the serial number is correct and locked, continue the procedure with 6. If the serial number is correct but not locked, continue the procedure with 5. If the serial number is not correct, but is locked, this feature cannot be enabled and the remainder of this procedure cannot be performed. Contact [#unique_17](#) to get an incorrect and locked serial number changed. Refer to [#unique_17](#) for the contact information. The serial number can be found on a label affixed to the control shelf (shelf 1100).

3. Enter the correct serial number into the database using the `ent-serial-num` command with the `serial` parameter.

For this example, enter this command.

```
ent-serial-num:serial=<EAGLE's correct serial number>
```

When this command has successfully completed, the following message should appear.

```
rlghncxa03w 09-02-28 21:15:37 GMT EAGLE5 40.1.0
ENT-SERIAL-NUM: MASP A - COMPLTD
```

4. Verify that the serial number entered into was entered correctly using the `rtrv-serial-num` command. This is an example of the possible output.

```
rlghncxa03w 09-02-28 21:15:37 GMT EAGLE5 40.1.0
System serial number = nt00001231
```

System serial number is not locked.

```
rlghncxa03w 09-02-28 21:15:37 GMT EAGLE5 40.1.0
Command Completed.
```

If the serial number was not entered correctly, repeat and re-enter the correct serial number.

5. Lock the serial number in the database by entering the `ent-serial-num` command with the serial number shown in , if the serial number shown in is correct, or with the serial number shown in , if the serial number was changed in , and with the `lock=yes` parameter.

For this example, enter this command.

```
ent-serial-num:serial=<EAGLE's serial number>:lock=yes
```

When this command has successfully completed, the following message should appear.

```
rlghncxa03w 09-02-28 21:15:37 GMT EAGLE5 40.1.0
ENT-SERIAL-NUM: MASP A - COMPLTD
```

6. To enable the GTT Load Sharing with Alternate Routing Indicator feature, the IGTTLS feature must be enabled and turned on, and the Flexible GTT Load Sharing feature must be enabled.

If the `rtrv-ctrl-feat` output in that the IGTTLS is enabled and turned on (shown by the entry `Intermed GTT Load Sharing`), and the Flexible GTT Load Sharing feature is enabled (shown by the entry `Flexible GTT Load Sharing`), continue the procedure with .

If the IGTTLS feature is not enabled and turned on, perform [Activating the IGTTLS feature](#) to enable and turn on the IGTTLS feature.

If the Flexible GTT Load Sharing feature is not enabled, perform the [Activating the Flexible GTT Load Sharing Feature](#) to enable the Flexible GTT Load Sharing feature.

After the IGTTLS has been enabled and turned on, and the Flexible GTT Load Sharing feature has been enabled, continue the procedure with 7.

7. Enable the GTT Load Sharing with Alternate Routing Indicator feature with the `enable-ctrl-feat` command specifying the part number for the GTT Load Sharing with Alternate Routing Indicator feature and the feature access key. Enter this command.

```
enable-ctrl-feat:partnum=893027401:fak=<GTT Load Sharing with  
Alternate Routing Indicator feature access key>
```

The GTT Load Sharing with Alternate Routing Indicator feature cannot be enabled with a temporary feature access key.

The values for the feature access key (the `fak` parameter) are provided by Oracle. If you do not have the feature access key for the GTT Load Sharing with Alternate Routing Indicator feature, contact your Oracle Sales Representative or Account Representative.

When the `enable-ctrl-feat` command has successfully completed, this message should appear.

```
rlghncxa03w 09-02-28 21:15:37 GMT EAGLE5 40.1.0  
ENABLE-CTRL-FEAT: MASP B - COMPLTD
```

Caution:

Once the GTT Load Sharing with Alternate Routing Indicator feature is enabled, provisioning for GTT Load Sharing with Alternate Routing Indicator feature can be performed, but load sharing using alternate routing indicators will not be performed, until the GTT Load Sharing with Alternate Routing Indicator is turned on in 8.

8. Turn the GTT Load Sharing with Alternate Routing Indicator feature on with the `chg-ctrl-feat` command specifying the part number for the GTT Load Sharing with Alternate Routing Indicator feature and the `status=on` parameter. Enter this command.

```
chg-ctrl-feat:partnum=893027401:status=on
```

When the `chg-ctrl-feat` command has successfully completed, this message should appear.

```
rlghncxa03w 09-02-28 21:15:37 GMT EAGLE5 40.1.0  
CHG-CTRL-FEAT: MASP B - COMPLTD
```

9. Verify the changes by entering the `rtrv-ctrl-feat` command with the GTT Load Sharing with Alternate Routing Indicator feature part number. Enter this command.

```
rtrv-ctrl-feat:partnum=893027401
```

The following is an example of the possible output.

```
rlghncxa03w 09-02-28 21:15:37 GMT EAGLE5 40.1.0
```

The following features have been permanently enabled:

Feature Name	Partnum	Status	Quantity
GTT LS ARI	893027401	on	----

The following features have been temporarily enabled:

Feature Name	Partnum	Status	Quantity	Trial Period Left
Zero entries found.				

The following features have expired temporary keys:

Feature Name	Partnum
Zero entries found.	

10. Backup the new changes using the `chg-db:action=backup:dest=fixed` command. These messages should appear, the active Maintenance and Administration Subsystem Processor (MASP) appears first.

```
BACKUP (FIXED) : MASP A - Backup starts on active MASP.
```

```
BACKUP (FIXED) : MASP A - Backup on active MASP to fixed disk  
complete.
```

```
BACKUP (FIXED) : MASP A - Backup starts on standby MASP.
```

```
BACKUP (FIXED) : MASP A - Backup on standby MASP to fixed disk  
complete.
```

Figure 5-52 Activate the GTT Load Sharing with Alternate Routing Indicator Feature - Sheet 1 of 5

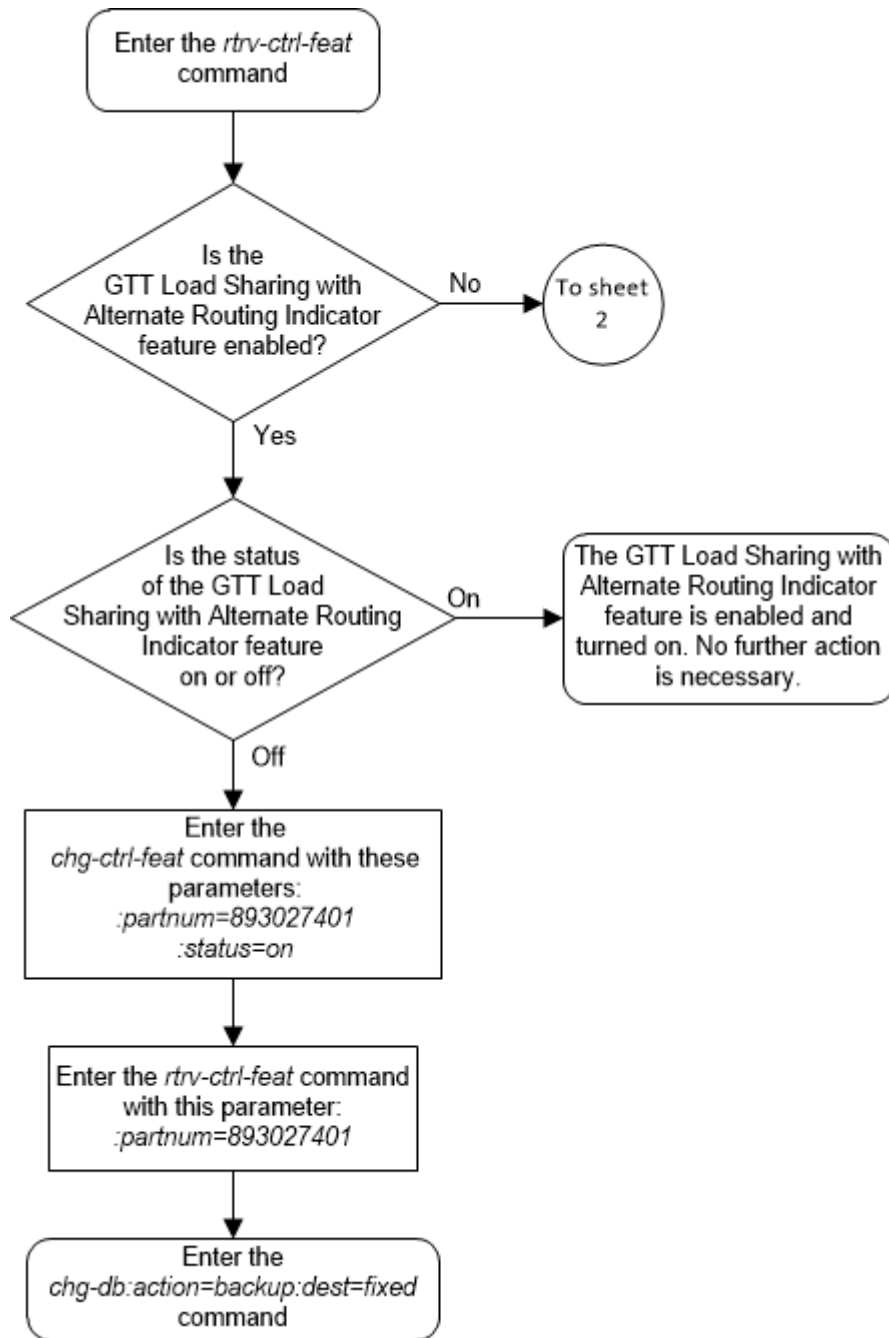
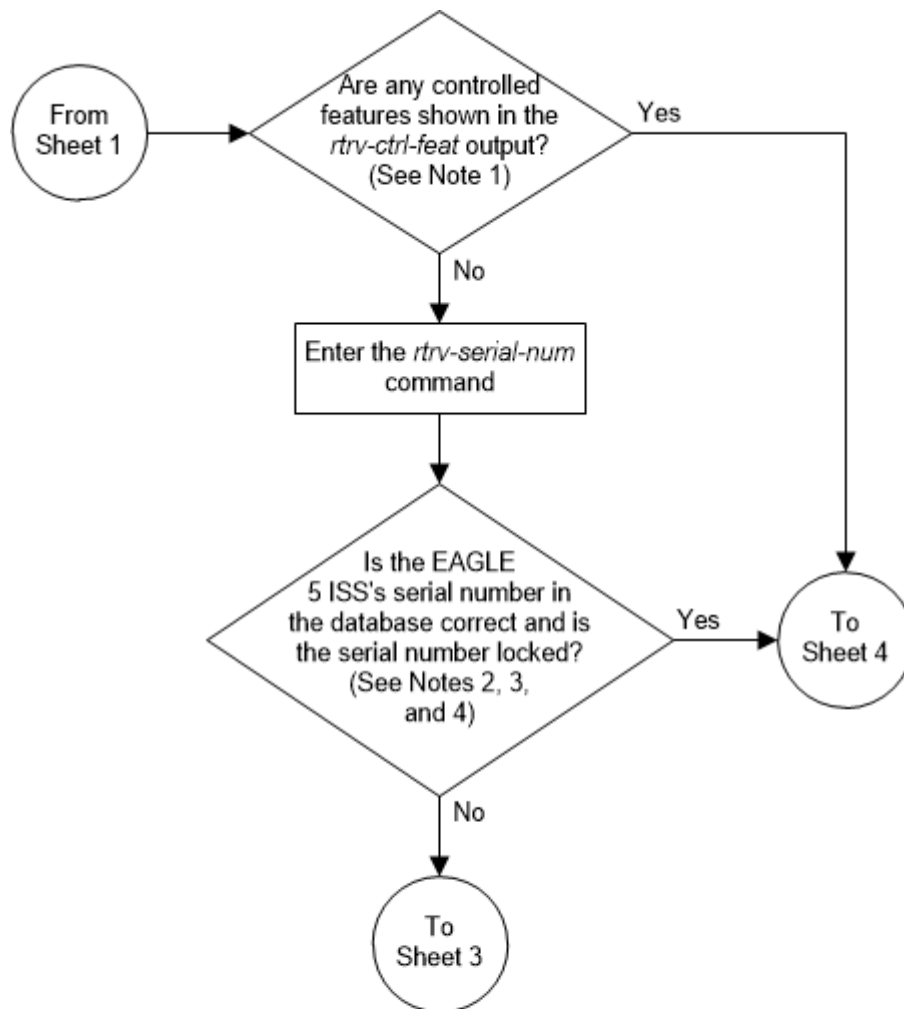

Figure 5-53 Activate the GTT Load Sharing with Alternate Routing Indicator Feature -Sheet 2 of 5



- Notes:
1. If the *rtrv-ctrl-feat* output shows only the HC-MIM SLK Capacity feature with a quantity of 64, the answer to this question is "no" and the EAGLE 5 ISS's serial number must be verified. This is the default entry for the *rtrv-ctrl-feat* output. This entry is shown whether or not the EAGLE 5 ISS's serial number is in the database.
 2. If the serial number is locked, it cannot be changed.
 3. If the serial number is not locked, the controlled feature cannot be enabled.
 4. The serial number can be found on a label affixed to the control shelf (shelf 1100).

Figure 5-54 Activate the GTT Load Sharing with Alternate Routing Indicator Feature -Sheet 3 of 5

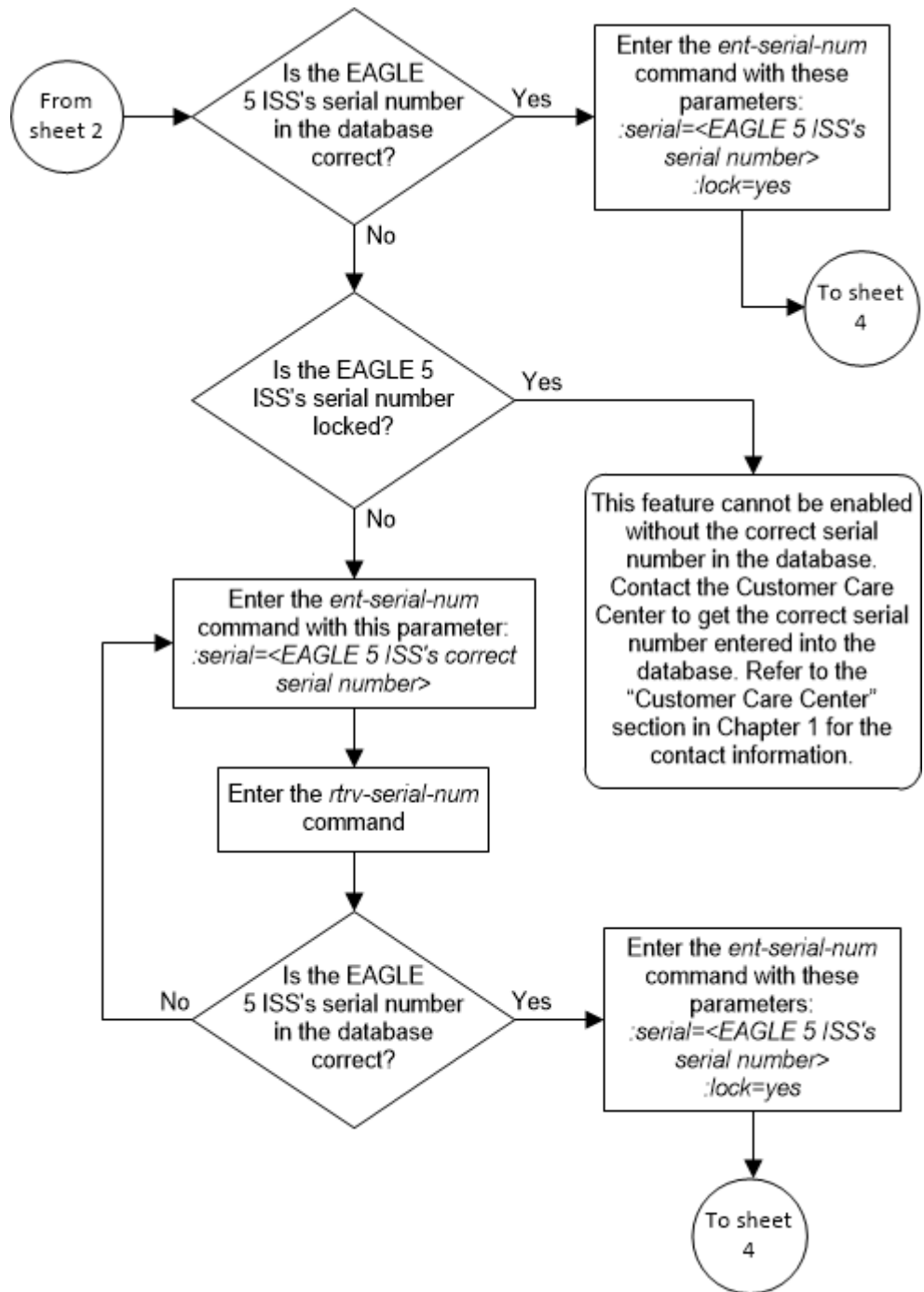

Figure 5-55 Activate the GTT Load Sharing with Alternate Routing Indicator Feature -Sheet 4 of 5

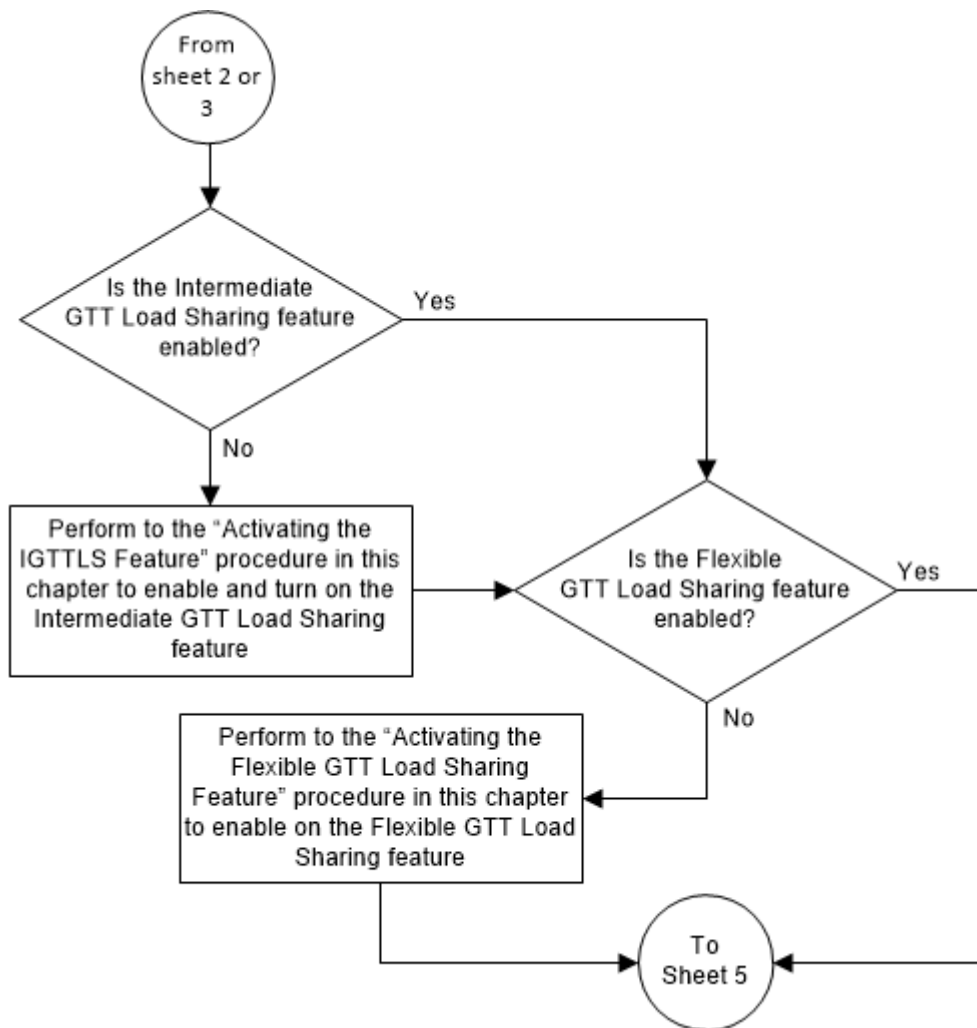
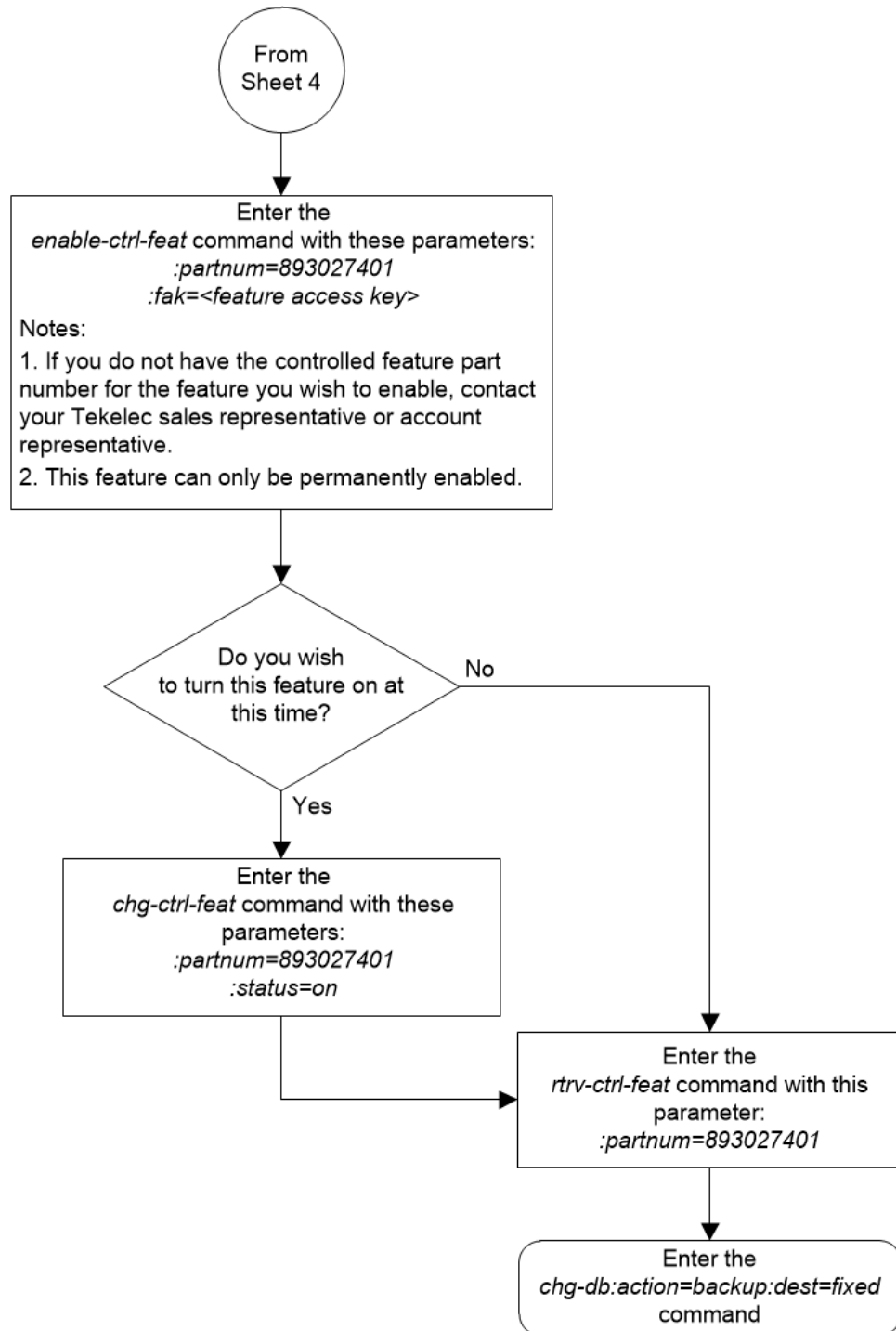

Figure 5-56 Activate the GTT Load Sharing with Alternate Routing Indicator Feature -Sheet 5 of 5



Turning Off the GTT Load Sharing with Alternate Routing Indicator Feature

This procedure is used to turn off the GTT Load Sharing with Alternate Routing Indicator feature, using the `chg-ctrl-feat` command.

The `chg-ctrl-feat` command uses the following parameters:

`:partnum` - The part number of the GTT Load Sharing with Alternate Routing Indicator feature, 893027401.

`:status=off` – used to turn off the GTT Load Sharing with Alternate Routing Indicator feature.

The status of the GTT Load Sharing with Alternate Routing Indicator feature must be on and is shown with the `rtrv-ctrl-feat` command.

Caution:

If the GTT Load Sharing with Alternate Routing Indicator feature is turned off, provisioning for the GTT Load Sharing with Alternate Routing Indicator feature can be performed, but load sharing using alternate routing indicators will not be performed.

1. Display the status of the GTT Load Sharing with Alternate Routing Indicator feature by entering the `rtrv-ctrl-feat:partnum=893027401` command.

The following is an example of the possible output.

```
rlghncxa03w 09-02-28 21:15:37 GMT EAGLE5 40.1.0
The following features have been permanently enabled:
```

Feature Name	Partnum	Status	Quantity
GTT LS ARI	893027401	on	----

```
The following features have been temporarily enabled:
```

Feature Name	Partnum	Status	Quantity	Trial
Period Left				
Zero entries found.				

```
The following features have expired temporary keys:
```

Feature Name	Partnum
Zero entries found.	

If the status of the GTT Load Sharing with Alternate Routing Indicator feature is off, or if the GTT Load Sharing with Alternate Routing Indicator feature is not enabled, this procedure cannot be performed.

2. Turn off the GTT Load Sharing with Alternate Routing Indicator feature by entering the `chg-ctrl-feat` command with the `status=off` parameter.

For example, enter this command.

```
chg-ctrl-feat:partnum=893027401:status=off
```

When this command has successfully completed, the following message should appear.

```
rlghncxa03w 09-02-28 21:16:37 GMT EAGLE5 40.1.0
CHG-CTRL-FEAT: MASP A - COMPLTD
```

3. Verify that the GTT Load Sharing with Alternate Routing Indicator feature has been turned off by using the `rtrv-ctrl-feat:partnum=893027401` command. The following is an example of the possible output.

```
rlghncxa03w 09-02-28 21:15:37 GMT EAGLE5 40.1.0
The following features have been permanently enabled:
```

Feature Name	Partnum	Status	Quantity
GTT LS ARI	893027401	off	----

The following features have been temporarily enabled:

Feature Name	Partnum	Status	Quantity	Trial
Period Left				
Zero entries found.				

The following features have expired temporary keys:

Feature Name	Partnum
Zero entries found.	

4. Back up the new changes using the `chg-db:action=backup:dest=fixed` command.

These messages should appear, the active Maintenance and Administration Subsystem Processor (MASP) appears first.

```
BACKUP (FIXED) : MASP A - Backup starts on active MASP.
BACKUP (FIXED) : MASP A - Backup on active MASP to fixed disk
complete.
BACKUP (FIXED) : MASP A - Backup starts on standby MASP.
BACKUP (FIXED) : MASP A - Backup on standby MASP to fixed disk
complete.
```

Figure 5-57 Turn Off the GTT Load Sharing with Alternate Routing Indicator Feature

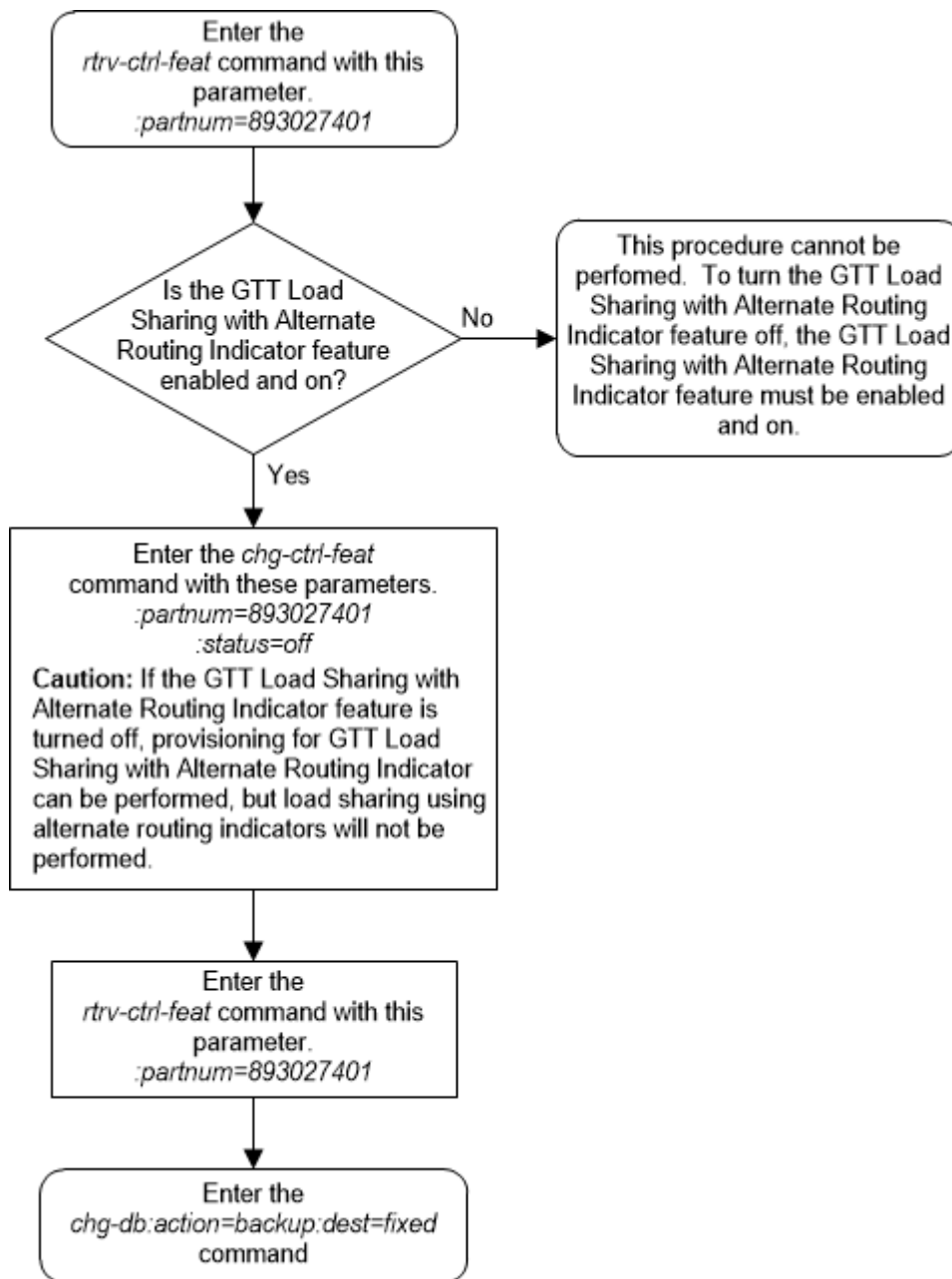

Activating the Support for 16 GTT Lengths in VGTT Feature

This procedure is used to enable and turn on the Support for 16 GTT Lengths in VGTT feature using the feature's part number and a feature access key.

This feature allows the translation type or GTT set to contain 11 to 16 global title addresses of different lengths.

The feature access key for the Support for 16 GTT Lengths in VGTT feature is based on the feature's part number and the serial number of the EAGLE, making the feature access key site-specific.

The `enable-ctrl-feat` command enables the feature by inputting the feature's access key and the feature's part number with these parameters:

`:fak` – The feature access key provided by Oracle. The feature access key contains 13 alphanumeric characters and is not case sensitive.

`:partnum` – The Oracle-issued part number of the Support for 16 GTT Lengths in VGTT feature, 893024801.

The `enable-ctrl-feat` command requires that the database contain a valid serial number for the EAGLE, and that this serial number is locked. This can be verified with the `rtrv-serial-num` command. The EAGLE is shipped with a serial number in the database, but the serial number is not locked. The serial number can be changed, if necessary, and locked once the EAGLE is on-site, with the `ent-serial-num` command. The `ent-serial-num` command uses these parameters.

`:serial` – The serial number assigned to the EAGLE. The serial number is not case sensitive.

`:lock` – Specifies whether or not the serial number is locked. This parameter has only one value, `yes`, which locks the serial number. Once the serial number is locked, it cannot be changed.

 **Note:**

To enter and lock the EAGLE's serial number, the `ent-serial-num` command must be entered twice, once to add the correct serial number to the database with the `serial` parameter, then again with the `serial` and the `lock=yes` parameters to lock the serial number. You should verify that the serial number in the database is correct before locking the serial number. The serial number can be found on a label affixed to the control shelf (shelf 1100).

This feature cannot be temporarily enabled (with the temporary feature access key).

Once this feature has been enabled, the feature must be turned on with the `chg-ctrl-feat` command. The `chg-ctrl-feat` command uses these parameters:

`:partnum` – The Oracle-issued part number of the Support for 16 GTT Lengths in VGTT feature, 893024801.

`:status=on` – used to turn the Support for 16 GTT Lengths in VGTT feature on.

Once the Support for 16 GTT Lengths in VGTT feature has been turned on, it cannot be turned off.

The status of the features in the EAGLE is shown with the `rtrv-ctrl-feat` command.

Before the Support for 16 GTT Lengths in VGTT feature can be enabled, the VGTT feature must be turned on. The state of the VGTT feature can be verified using the `rtrv-feat` command.

1. Display the features that are enabled by entering the `rtrv-ctrl-feat` command. The following is an example of the possible output.

```
rlghncxa03w 09-05-28 21:15:37 GMT EAGLE5 41.0.0
```

The following features have been permanently enabled:

Feature Name	Partnum	Status	Quantity
Command Class Management	893005801	on	----
LNP Short Message Service	893006601	on	----
Intermed GTT Load Sharing	893006901	on	----
HC-MIM SLK Capacity	893012707	on	64

The following features have been temporarily enabled:

Feature Name	Partnum	Status	Quantity	Trial	Period Left
Zero entries found.					

The following features have expired temporary keys:

Feature Name	Partnum
Zero entries found.	

If the Support for 16 GTT Lengths in VGTT feature is enabled and turned on, shown by the entry `VGTT` with 16 GTT lengths in the `rtrv-ctrl-feat` output, no further action is necessary. This procedure does not need to be performed.

If the Support for 16 GTT Lengths in VGTT feature is enabled and but not turned on, continue the procedure with [9](#).

If the Support for 16 GTT Lengths in VGTT feature is not enabled, continue the procedure with [2](#).

2. Verify that the VGTT feature is on, by entering the `rtrv-feat` command. If the VGTT feature is on, the `VGTT` field should be set to `on`.

 **Note:**

The `rtrv-feat` command output contains other fields that are not used by this procedure. If you wish to see all the fields displayed by the `rtrv-feat` command, see the `rtrv-feat` command description in *Commands User's Guide*.

If the VGTT feature is on, continue the procedure with [4](#).

 **Note:**

If the `rtrv-ctrl-feat` output in [1](#) shows any controlled features, continue the procedure with [8](#). If the `rtrv-ctrl-feat` output shows only the HC-MIM SLK Capacity feature with a quantity of 64, [4](#) through [7](#) must be performed.

If the VGTT feature is off, continue the procedure with 3.

3. Turn the VGTT feature on by entering this command.

```
chg-feat:vgtt=on
```

If the GTT feature is not on, turn the GTT feature on by specifying the `gtt=on` parameter with the `vgtt=on` parameter.

 **Note:**

Once the VGTT feature is turned on with the `chg-feat` command, it cannot be turned off.

The VGTT feature must be purchased before turning it on. If you are not sure whether you have purchased the VGTT feature, contact your Oracle Sales Representative or Account Representative.

When the `chg-feat` has successfully completed, this message should appear.

```
rlghncxa03w 09-05-25 09:57:41 GMT EAGLE5 41.0.0  
CHG-FEAT: MASP A - COMPLTD
```

If the `rtrv-ctrl-feat` output in 1 shows any controlled features, continue the procedure with 8. If the `rtrv-ctrl-feat` output shows only the HC-MIM SLK Capacity feature with a quantity of 64, 4 through 7 must be performed.

4. Display the serial number in the database with the `rtrv-serial-num` command. This is an example of the possible output.

```
rlghncxa03w 09-05-28 21:15:37 GMT EAGLE5 41.0.0  
System serial number = nt00001231
```

System serial number is not locked.

```
rlghncxa03w 09-05-28 21:15:37 GMT EAGLE5 41.0.0  
Command Completed.
```

 **Note:**

If the serial number is correct and locked, continue the procedure with 8. If the serial number is correct but not locked, continue the procedure with 7. If the serial number is not correct, but is locked, this feature cannot be enabled and the remainder of this procedure cannot be performed. Contact the Customer Care Center to get an incorrect and locked serial number changed. Refer to [#unique_17](#) for the contact information. The serial number can be found on a label affixed to the control shelf (shelf 1100).

5. Enter the correct serial number into the database using the `ent-serial-num` command with the `serial` parameter.

For this example, enter this command.

```
ent-serial-num:serial=<EAGLE's correct serial number>
```

When this command has successfully completed, the following message should appear.

```
rlghncxa03w 09-05-28 21:15:37 GMT EAGLE5 41.0.0
ENT-SERIAL-NUM: MASP A - COMPLTD
```

6. Verify that the serial number entered into was entered correctly using the `rtrv-serial-num` command. This is an example of the possible output.

```
rlghncxa03w 09-05-28 21:15:37 GMT EAGLE5 41.0.0
System serial number = nt00001231
```

System serial number is not locked.

```
rlghncxa03w 09-05-28 21:15:37 GMT EAGLE5 41.0.0
Command Completed.
```

If the serial number was not entered correctly, repeat and re-enter the correct serial number.

7. Lock the serial number in the database by entering the `ent-serial-num` command with the serial number shown in , if the serial number shown in is correct, or with the serial number shown in , if the serial number was changed in , and with the `lock=yes` parameter.

For this example, enter this command.

```
ent-serial-num:serial=<EAGLE's serial number>:lock=yes
```

When this command has successfully completed, the following message should appear.

```
rlghncxa03w 09-05-28 21:15:37 GMT EAGLE5 41.0.0
ENT-SERIAL-NUM: MASP A - COMPLTD
```

8. Enable the Support for 16 GTT Lengths in VGTT feature with the `enable-ctrl-feat` command specifying the part number for the Support for 16 GTT Lengths in VGTT feature and the feature access key. Enter this command.

```
enable-ctrl-feat:partnum=893024801:fak=<Support for 16 GTT
Lengths in VGTT feature access key>
```

 **Note:**

The Support for 16 GTT Lengths in VGTT feature cannot be enabled with a temporary feature access key.

 **Note:**

The values for the feature access key (the `fa_k` parameter) are provided by Oracle. If you do not have the feature access key for the Support for 16 GTT Lengths in VGTT feature, contact your Oracle Sales Representative or Account Representative.

When the `enable-ctrl-feat` command has successfully completed, this message should appear.

```
rlghncxa03w 09-05-28 21:15:37 GMT EAGLE5 41.0.0  
ENABLE-CTRL-FEAT: MASP B - COMPLTD
```

If you wish to turn the Support for 16 GTT Lengths in VGTT feature on at this time, continue the procedure with .

If you do not wish to turn the Support for 16 GTT Lengths in VGTT feature on at this time, continue the procedure with .

 **Caution:**

If the Support for 16 GTT Lengths in VGTT feature is not turned on, provisioning for VGTT with 16 GTT Lengths cannot be performed.

9. Turn the Support for 16 GTT Lengths in VGTT feature on with the `chg-ctrl-feat` command specifying the part number for the Support for 16 GTT Lengths in VGTT feature and the `status=on` parameter.

Enter this command.

```
chg-ctrl-feat:partnum=893024801:status=on
```

 **Note:**

Once the Support for 16 GTT Lengths in VGTT feature is turned on, it cannot be turned off.

When the `chg-ctrl-feat` command has successfully completed, this message should appear.

```
rlghncxa03w 09-05-28 21:15:37 GMT EAGLE5 41.0.0  
CHG-CTRL-FEAT: MASP B - COMPLTD
```

10. Verify the changes by entering the `rtrv-ctrl-feat` command with the Support for 16 GTT Lengths in VGTT feature part number. Enter this command.

```
rtrv-ctrl-feat:partnum=893024801
```

The following is an example of the possible output.

```
rlghncxa03w 09-05-28 21:15:37 GMT EAGLE5 41.0.0
```

The following features have been permanently enabled:

Feature Name	Partnum	Status	Quantity
VGTT with 16 GTT lengths	893024801	on	----

The following features have been temporarily enabled:

Feature Name	Partnum	Status	Quantity	Trial Period Left
Zero entries found.				

The following features have expired temporary keys:

Feature Name	Partnum
Zero entries found.	

11. Backup the new changes using the `chg-db:action=backup:dest=fixed` command. These messages should appear, the active Maintenance and Administration Subsystem Processor (MASP) appears first.

```
BACKUP (FIXED) : MASP A - Backup starts on active MASP.
```

```
BACKUP (FIXED) : MASP A - Backup on active MASP to fixed disk  
complete.
```

```
BACKUP (FIXED) : MASP A - Backup starts on standby MASP.
```

```
BACKUP (FIXED) : MASP A - Backup on standby MASP to fixed disk  
complete.
```

Figure 5-58 Activate the Support for 16 GTT Lengths in VGTT Feature - Sheet 1 of 4

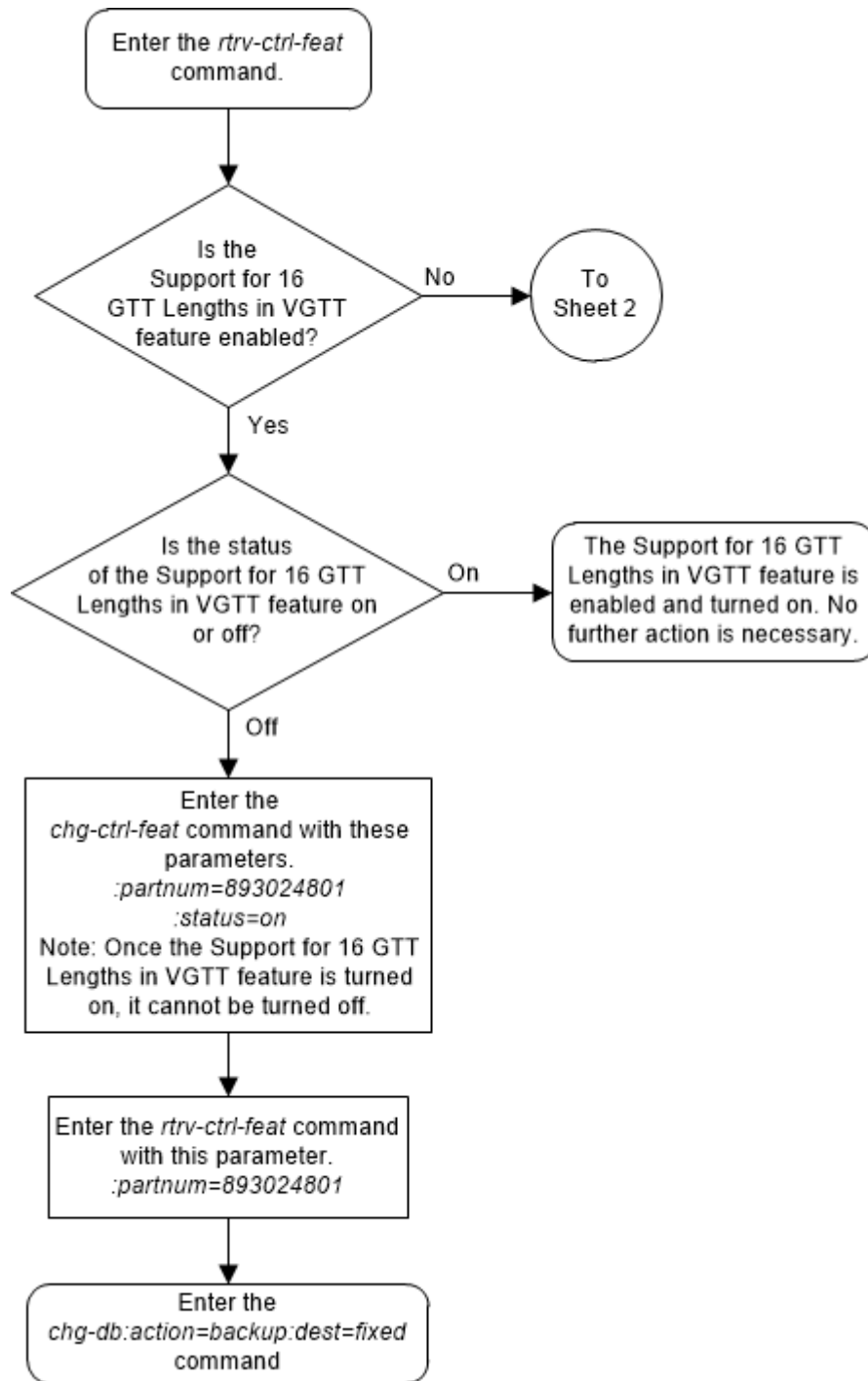
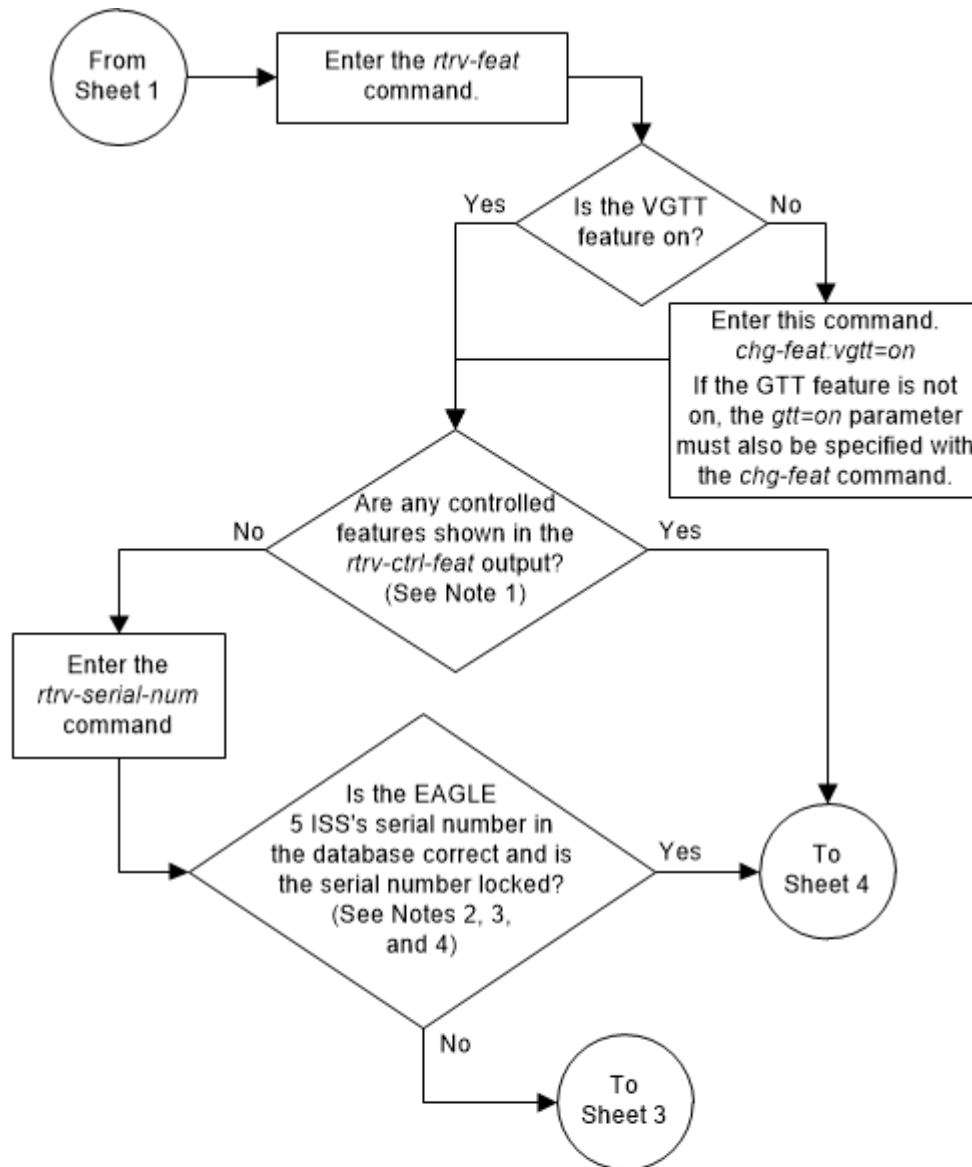

Figure 5-59 Activate the Support for 16 GTT Lengths in VGTT Feature - Sheet 2 of 4



Notes:

1. If the *rtrv-ctrl-feat* output shows only the HC-MIM SLK Capacity feature with a quantity of 64, the answer to this question is no and the Eagle 5 ISS's serial number must be verified. This is the default entry for the *rtrv-ctrl-feat* output. This entry is shown whether or not the Eagle 5 ISS's serial number is in the database.
2. If the serial number is locked, it cannot be changed.
3. If the serial number is not locked, the controlled feature cannot be enabled.
4. The serial number can be found on a label affixed to the control shelf (shelf 1100).

Figure 5-60 Activate the Support for 16 GTT Lengths in VGTT Feature - Sheet 3 of 4

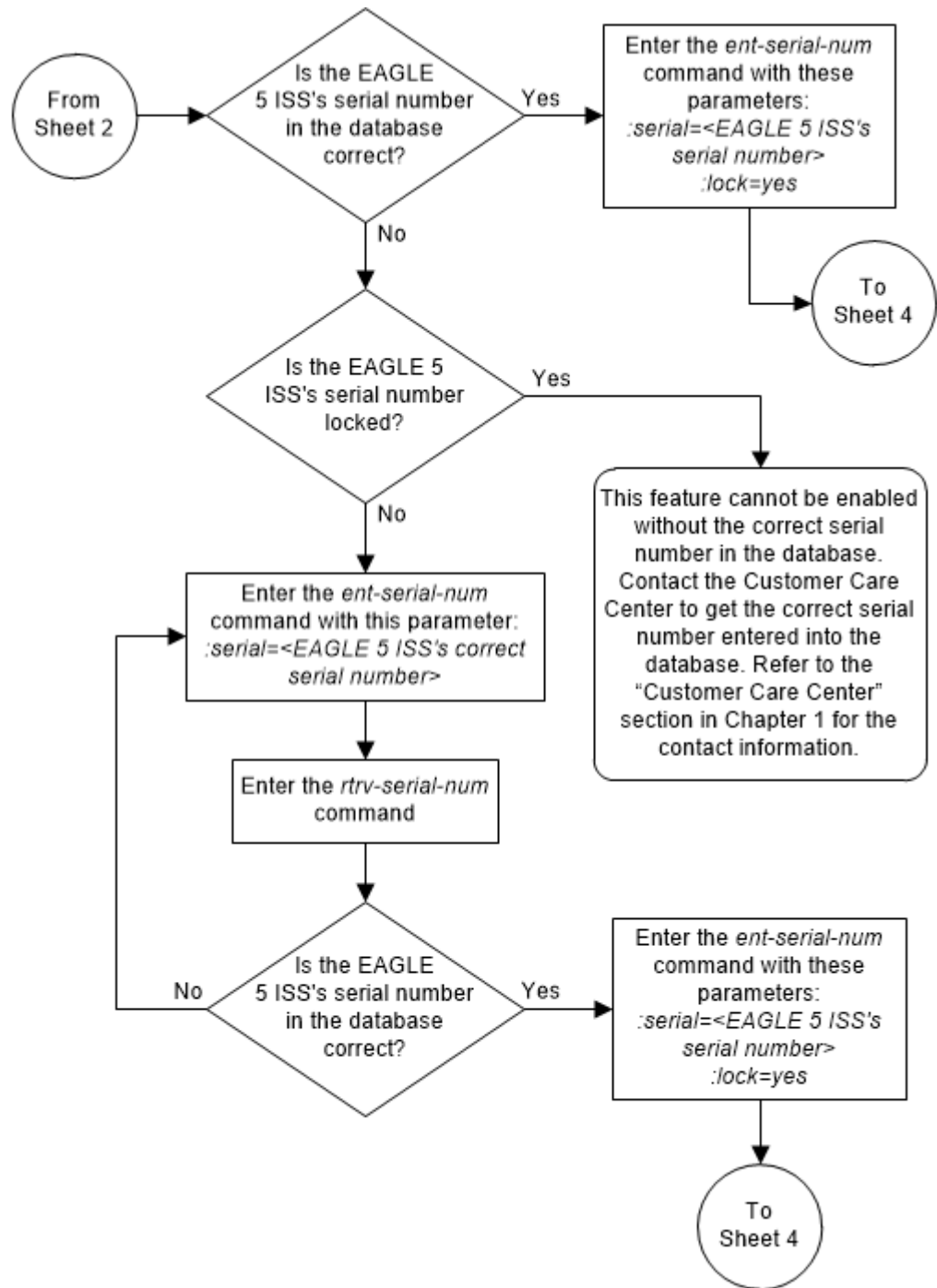
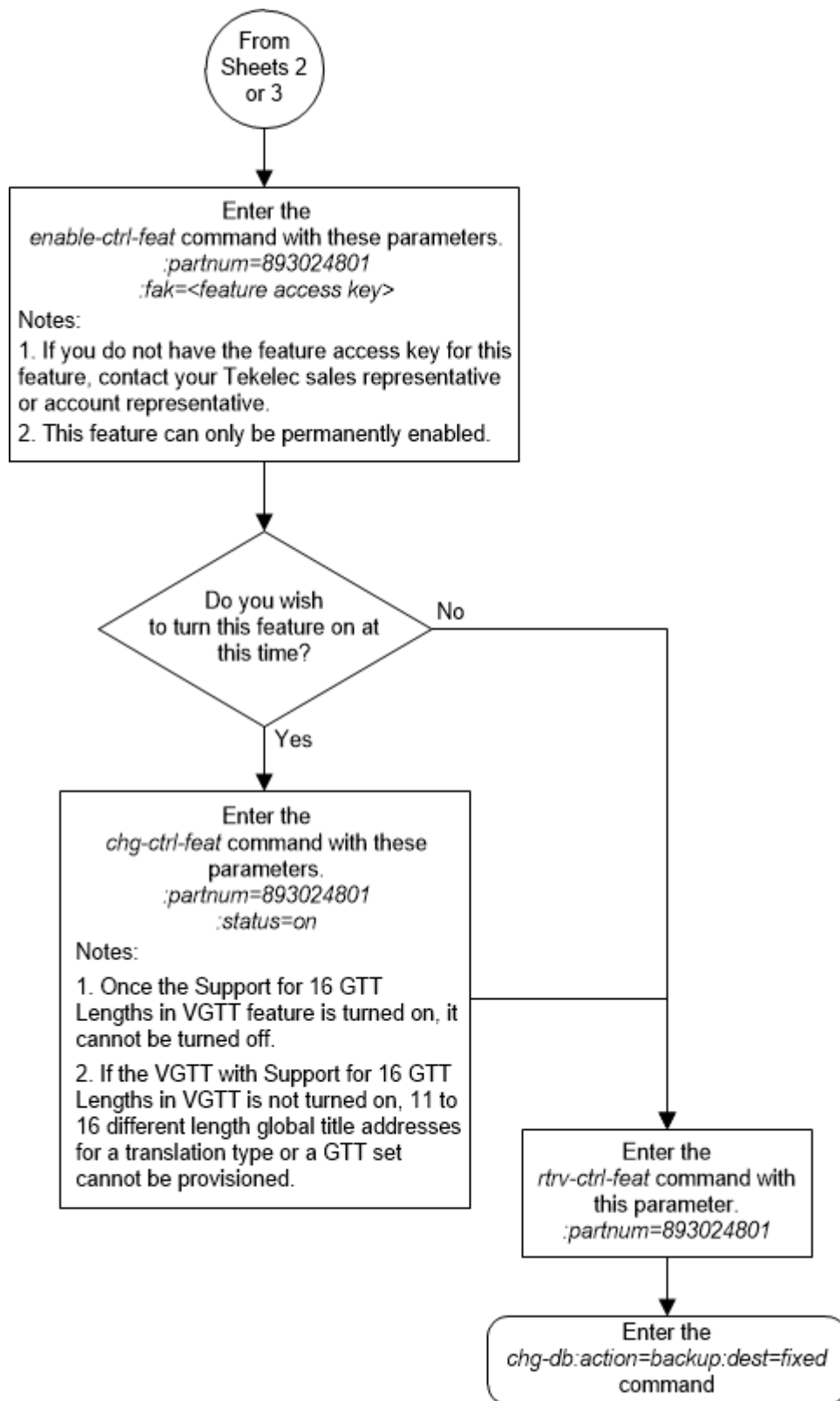

Figure 5-61 Activate the Support for 16 GTT Lengths in VGTT Feature - Sheet 4 of 4



Activating the Flexible Linkset Optional Based Routing Feature

This procedure is used to enable and turn on the Flexible Linkset Optional Based Routing feature using the feature's part number.

The feature access key for the Flexible Linkset Optional Based Routing feature is based on the feature's part number and the serial number of the EAGLE, making the feature access key site-specific.

The `enable-ctrl-feat` command enables the feature by inputting the feature's access key and the feature's part number with these parameters:

`:fak` – The feature access key provided by Oracle. The feature access key contains 13 alphanumeric characters and is not case sensitive.

`:partnum` – The Oracle-issued part number of the Flexible Linkset Optional Based Routing feature, 893027701.

The `enable-ctrl-feat` command requires that the database contain a valid serial number for the EAGLE, and that this serial number is locked. This can be verified with the `rtrv-serial-num` command. The EAGLE is shipped with a serial number in the database, but the serial number is not locked. The serial number can be changed, if necessary, and locked once the EAGLE is on-site, with the `ent-serial-num` command. The `ent-serial-num` command uses these parameters.

`:serial` – The serial number assigned to the EAGLE. The serial number is not case sensitive.

`:lock` – Specifies whether or not the serial number is locked. This parameter has only one value, `yes`, which locks the serial number. Once the serial number is locked, it cannot be changed.

Note:

To enter and lock the EAGLE's serial number, the `ent-serial-num` command must be entered twice, once to add the correct serial number to the database with the `serial` parameter, then again with the `serial` and the `lock=yes` parameters to lock the serial number. You should verify that the serial number in the database is correct before locking the serial number. The serial number can be found on a label affixed to the control shelf (shelf 1100).

This feature cannot be temporarily enabled (with the temporary feature access key).

Once this feature has been enabled, the feature must be turned on with the `chg-ctrl-feat` command. The `chg-ctrl-feat` command uses these parameters:

`:partnum` – The Oracle-issued part number of the Flexible Linkset Optional Based Routing feature, 893027701.

`:status=on` – used to turn the Flexible Linkset Optional Based Routing feature on.

Once the Flexible Linkset Optional Based Routing feature has been turned on, it cannot be turned off.

The status of the features in the EAGLE is shown with the `rtrv-ctrl-feat` command.

Before the Flexible Linkset Optional Based Routing feature can be enabled, the EGTT feature must be turned on. The state of the EGTT feature can be verified using the `rtrv-feat` command.

1. Display the features that are enabled by entering the `rtrv-ctrl-feat` command. The following is an example of the possible output.

```
rlghncxa03w 09-05-28 21:15:37 GMT EAGLE5 41.0.0
The following features have been permanently enabled:
```

Feature Name	Partnum	Status	Quantity
Command Class Management	893005801	on	----
LNP Short Message Service	893006601	on	----
Intermed GTT Load Sharing	893006901	on	----
HC-MIM SLK Capacity	893012707	on	64

The following features have been temporarily enabled:

Feature Name	Partnum	Status	Quantity	Trial	Period Left
Zero entries found.					

The following features have expired temporary keys:

Feature Name	Partnum
Zero entries found.	

If the Flexible Linkset Optional Based Routing feature is enabled and turned on, no further action is necessary. This procedure does not need to be performed.

If the Flexible Linkset Optional Based Routing feature is enabled and but not turned on, continue the procedure with [9](#).

If the Flexible Linkset Optional Based Routing feature is not enabled, continue the procedure with [2](#).

2. Verify that the EGTT feature is on, by entering the `rtrv-feat` command. If the EGTT feature is on, the EGTT field should be set to `on`.

 **Note:**

The `rtrv-feat` command output contains other fields that are not used by this procedure. If you wish to see all the fields displayed by the `rtrv-feat` command, see the `rtrv-feat` command description in *Commands User's Guide*.

If the EGTT feature is on, shown by the entry `EGTT = on`, continue the procedure with [4](#).

 **Note:**

If the `rtrv-ctrl-feat` output in 1 shows any controlled features, continue the procedure with 8. If the `rtrv-ctrl-feat` output shows only the HC-MIM SLK Capacity feature with a quantity of 64, 4 through 7 must be performed.

If the EGTT feature is off, continue the procedure with 3.

3. Turn the enhanced global title translation feature on by entering this command.

```
chg-feat:egtt=on
```

If the GTT feature is not on, turn the GTT feature on by specifying the `gtt=on` parameter with the `egtt=on` parameter.

 **Note:**

Once the Enhanced Global Title Translation (EGTT) feature is turned on with the `chg-feat` command, it cannot be turned off. The EGTT feature must be purchased before turning it on. If you are not sure whether you have purchased the EGTT feature, contact your Oracle Sales Representative or Account Representative.

When the `chg-feat` has successfully completed, this message should appear.

```
rlghncxa03w 09-05-25 09:57:41 GMT EAGLE5 41.0.0  
CHG-FEAT: MASP A - COMPLTD
```

 **Note:**

If the `rtrv-ctrl-feat` output in 1 shows any controlled features, continue the procedure with 8. If the `rtrv-ctrl-feat` output shows only the HC-MIM SLK Capacity feature with a quantity of 64, 4 through 7 must be performed.

4. Display the serial number in the database with the `rtrv-serial-num` command. This is an example of the possible output.

```
rlghncxa03w 09-05-28 21:15:37 GMT EAGLE5 41.0.0  
System serial number = nt00001231
```

System serial number is not locked.

```
rlghncxa03w 09-05-28 21:15:37 GMT EAGLE5 41.0.0  
Command Completed.
```

 **Note:**

If the serial number is correct and locked, continue the procedure with 8. If the serial number is correct but not locked, continue the procedure with 7. If the serial number is not correct, but is locked, this feature cannot be enabled and the remainder of this procedure cannot be performed. Contact My Oracle Support to get an incorrect and locked serial number changed. Refer to [#unique_17](#) for the contact information. The serial number can be found on a label affixed to the control shelf (shelf 1100).

5. Enter the correct serial number into the database using the `ent-serial-num` command with the `serial` parameter.

For this example, enter this command.

```
ent-serial-num:serial=<EAGLE's correct serial number>
```

When this command has successfully completed, the following message should appear.

```
rlghncxa03w 09-05-28 21:15:37 GMT EAGLE5 41.0.0
ENT-SERIAL-NUM: MASP A - COMPLTD
```

6. Verify that the serial number entered into was entered correctly using the `rtrv-serial-num` command. This is an example of the possible output.

```
rlghncxa03w 09-05-28 21:15:37 GMT EAGLE5 41.0.0
System serial number = nt00001231
```

System serial number is not locked.

```
rlghncxa03w 09-05-28 21:15:37 GMT EAGLE5 41.0.0
Command Completed.
```

If the serial number was not entered correctly, repeat and re-enter the correct serial number.

7. Lock the serial number in the database by entering the `ent-serial-num` command with the serial number shown in , if the serial number shown in is correct, or with the serial number shown in , if the serial number was changed in , and with the `lock=yes` parameter.

For this example, enter this command.

```
ent-serial-num:serial=<EAGLE's serial number>:lock=yes
```

When this command has successfully completed, the following message should appear.

```
rlghncxa03w 09-05-28 21:15:37 GMT EAGLE5 41.0.0
ENT-SERIAL-NUM: MASP A - COMPLTD
```

8. Enable the Flexible Linkset Optional Based Routing feature with the `enable-ctrl-feat` command specifying the part number for the Flexible Linkset Optional Based Routing feature and the feature access key. Enter this command.

```
enable-ctrl-feat:partnum=893027701:fak=<Flexible Linkset  
Optional Based Routing feature access key>
```

 **Note:**

The Flexible Linkset Optional Based Routing feature cannot be enabled with a temporary feature access key.

 **Note:**

The values for the feature access key (the `fak` parameter) are provided by Oracle. If you do not have the feature access key for the Flexible Linkset Optional Based Routing feature, contact your Oracle Sales Representative or Account Representative.

When the `enable-ctrl-feat` command has successfully completed, this message should appear.

```
rlghncxa03w 09-05-28 21:15:37 GMT EAGLE5 41.0.0  
ENABLE-CTRL-FEAT: MASP B - COMPLTD
```

If you wish to turn the Flexible Linkset Optional Based Routing feature on at this time, continue the procedure with .

If you do not wish to turn the Flexible Linkset Optional Based Routing feature on at this time, continue the procedure with .

 **Caution:**

If the Flexible Linkset Optional Based Routing feature is not turned on, provisioning for Flexible Linkset Optional Based Routing cannot be performed.

9. Turn the Flexible Linkset Optional Based Routing feature on with the `chg-ctrl-feat` command specifying the part number for the Flexible Linkset Optional Based Routing feature and the `status=on` parameter.

Enter this command.

```
chg-ctrl-feat:partnum=893027701:status=on
```

When the `chg-ctrl-feat` command has successfully completed, this message should appear.

```
rlghncxa03w 09-05-28 21:15:37 GMT EAGLE5 41.0.0  
CHG-CTRL-FEAT: MASP B - COMPLTD
```

10. Verify the changes by entering the `rtrv-ctrl-feat` command with the Flexible Linkset Optional Based Routing feature part number. Enter this command.

```
rtrv-ctrl-feat:partnum=893027701
```

The following is an example of the possible output.

```
rlghncxa03w 09-05-28 21:15:37 GMT EAGLE5 41.0.0
```

The following features have been permanently enabled:

Feature Name	Partnum	Status	Quantity
Flex Lset Optnl Based Rtg	893027701	on	----

The following features have been temporarily enabled:

Feature Name	Partnum	Status	Quantity	Trial
Period Left				
Zero entries found.				

The following features have expired temporary keys:

Feature Name	Partnum
Zero entries found.	

- Backup the new changes using the `chg-db:action=backup:dest=fixed` command. These messages should appear, the active Maintenance and Administration Subsystem Processor (MASP) appears first.

```
BACKUP (FIXED) : MASP A - Backup starts on active MASP.
```

```
BACKUP (FIXED) : MASP A - Backup on active MASP to fixed disk complete.
```

```
BACKUP (FIXED) : MASP A - Backup starts on standby MASP.
```

```
BACKUP (FIXED) : MASP A - Backup on standby MASP to fixed disk complete.
```

Figure 5-62 Activate the Flexible Linkset Optional Based Routing Feature - Sheet 1 of 4

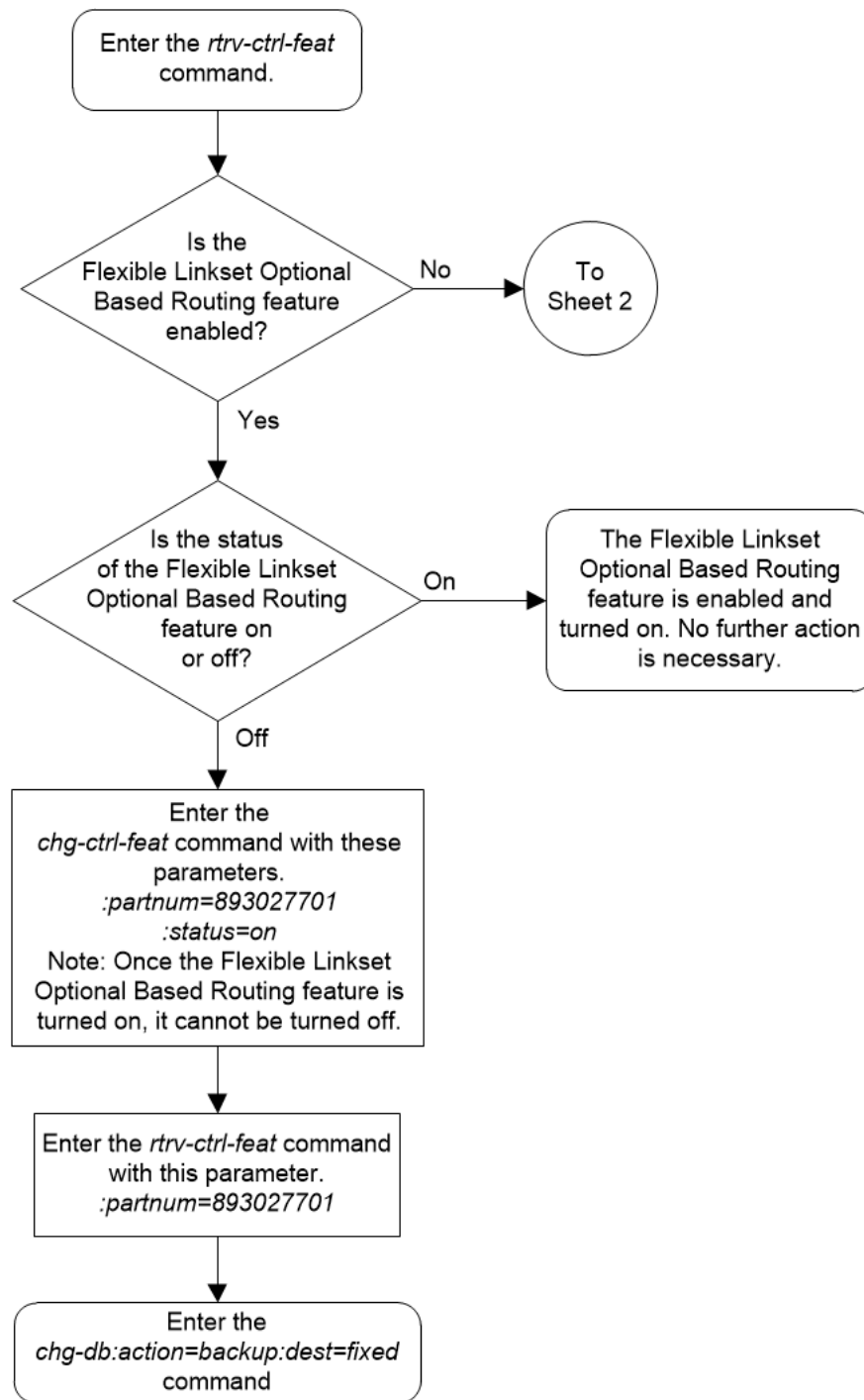
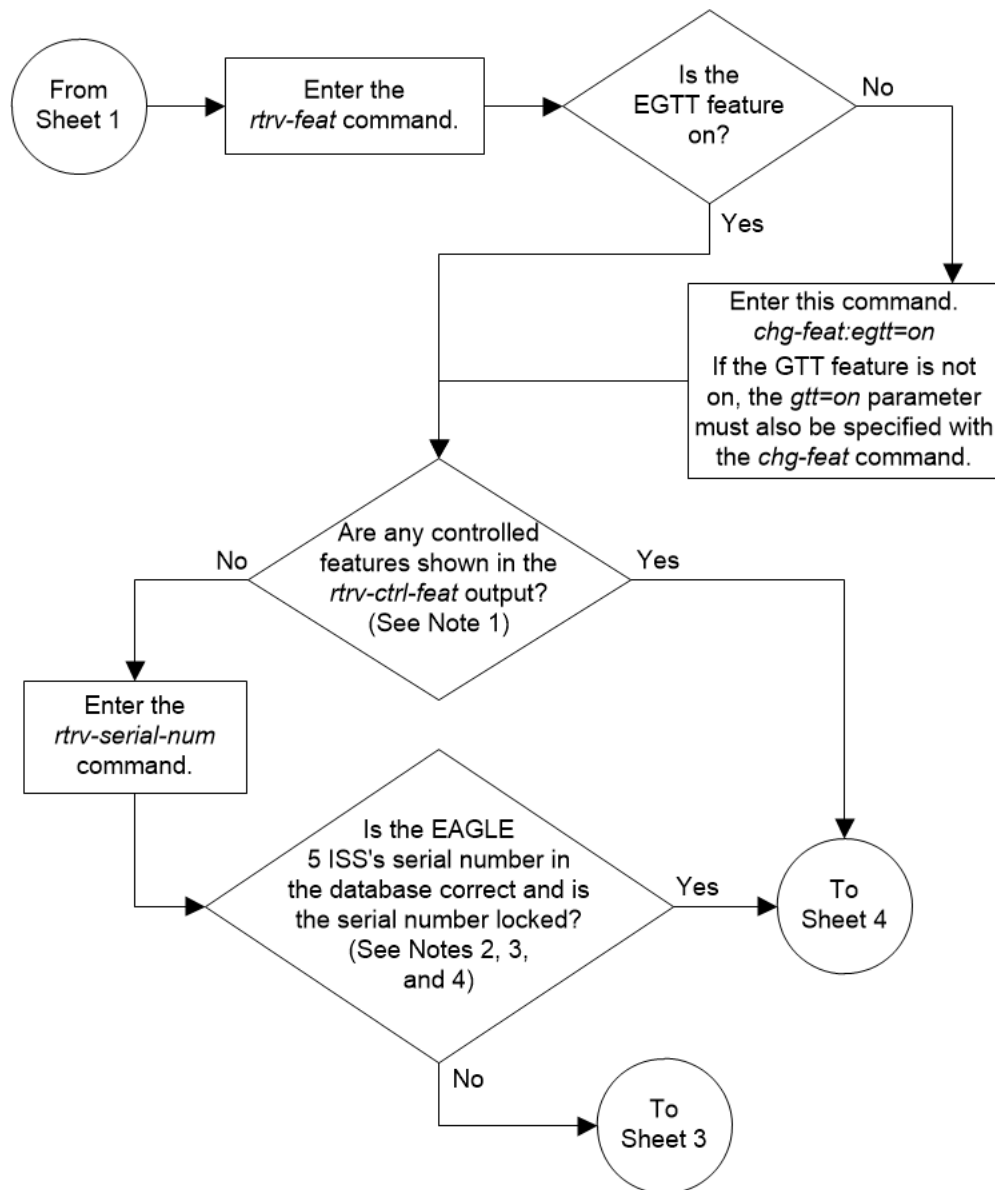

Figure 5-63 Activate the Flexible Linkset Optional Based Routing Feature - Sheet 2 of 4



Notes:

1. If the *rtrv-ctrl-feat* output shows only the HC -MIM SLK Capacity feature with a quantity of 64, the answer to this question is no and the Eagle 5 ISS's serial number must be verified. This is the default entry for the *rtrv-ctrl-feat* output. This entry is shown whether or not the Eagle 5 ISS's serial number is in the database.
2. If the serial number is locked, it cannot be changed.
3. If the serial number is not locked, the controlled feature cannot be enabled.
4. The serial number can be found on a label affixed to the control shelf (shelf 1100).

Figure 5-64 Activate the Flexible Linkset Optional Based Routing Feature - Sheet 3 of 4

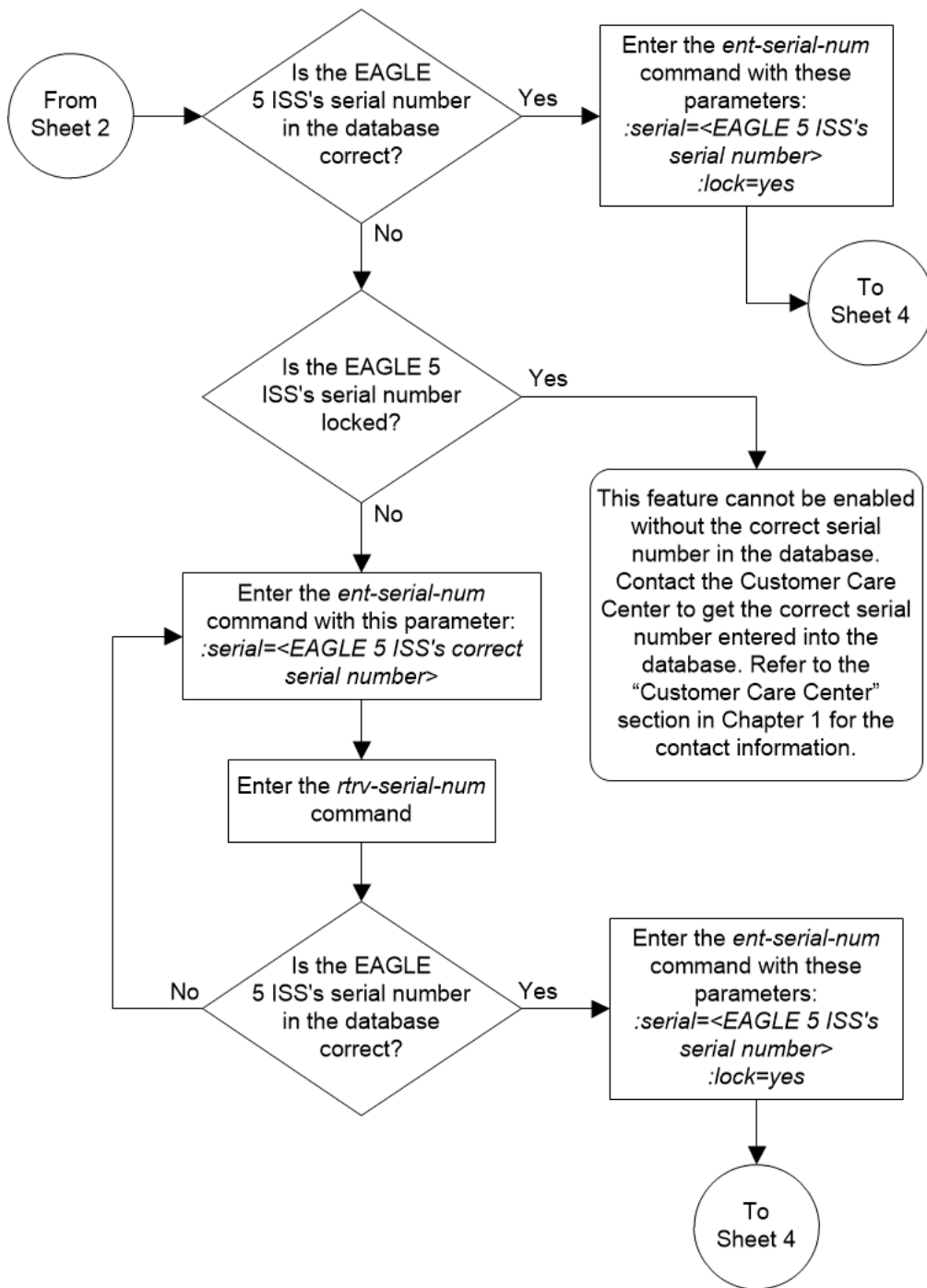
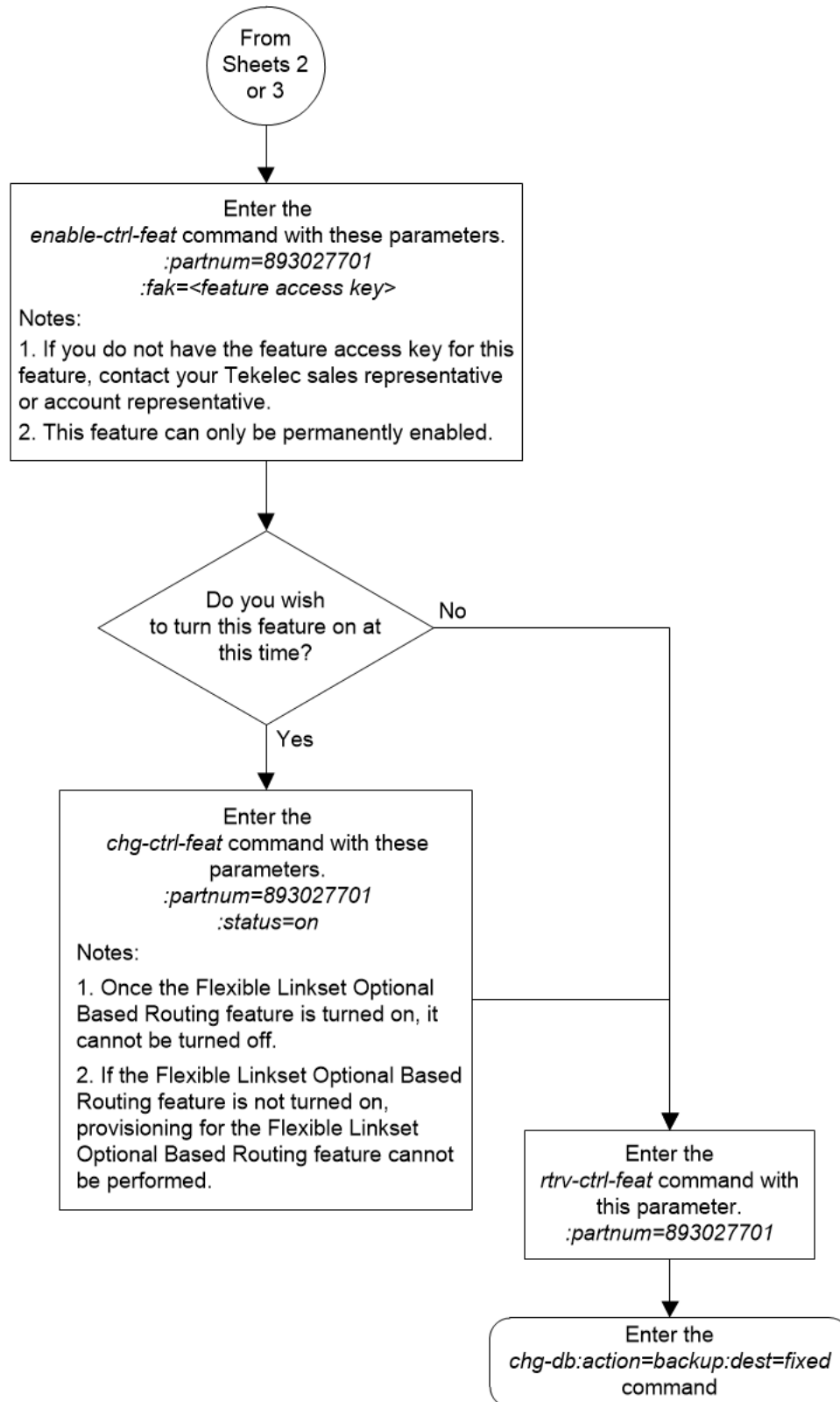

Figure 5-65 Activate the Flexible Linkset Optional Based Routing Feature - Sheet 4 of 4



Activating the TCAP Opcode Based Routing Feature

This procedure is used to enable and turn on the TCAP Opcode Based Routing feature using the feature's part number and a feature access key.

The feature access key for the TCAP Opcode Based Routing feature is based on the feature's part number and the serial number of the EAGLE, making the feature access key site-specific.

The `enable-ctrl-feat` command enables the feature by inputting the feature's access key and the feature's part number with these parameters:

`:fak` – The feature access key provided by Oracle. The feature access key contains 13 alphanumeric characters and is not case sensitive.

`:partnum` – The Oracle-issued part number of the TCAP Opcode Based Routing feature, 893027801.

This feature cannot be temporarily enabled (with the temporary feature access key).

Once this feature has been enabled, the feature must be turned on with the `chg-ctrl-feat` command. The `chg-ctrl-feat` command uses these parameters:

`:partnum` – The Oracle-issued part number of the TCAP Opcode Based Routing feature, 893027801.

`:status=on` – used to turn the TCAP Opcode Based Routing feature on.

Once the TCAP Opcode Based Routing feature has been turned on, it cannot be turned off.

Before the TCAP Opcode Based Routing feature can be enabled and turned on, the Flexible Linkset Optional Based Routing feature must be enabled and turned on. The status of the TCAP Opcode Based Routing feature and the Flexible Linkset Optional Based Routing feature is shown with the `rtrv-ctrl-feat` command.

1. Display the status of the TCAP Opcode Based Routing feature by entering the `rtrv-ctrl-feat` command. The following is an example of the possible output.

```
rlghncxa03w 09-05-28 21:15:37 GMT EAGLE5 41.0.0  
The following features have been permanently enabled:
```

Feature Name	Partnum	Status	Quantity
Command Class Management	893005801	on	----
LNP Short Message Service	893006601	on	----
Intermed GTT Load Sharing	893006901	on	----
HC-MIM SLK Capacity	893012707	on	64

```
The following features have been temporarily enabled:
```

Feature Name	Partnum	Status	Quantity	Trial
Period Left				
Zero entries found.				

```
The following features have expired temporary keys:
```

```
Feature Name          Partnum
Zero entries found.
```

If the TCAP Opcode Based Routing feature is enabled and turned on, no further action is necessary. This procedure does not need to be performed.

If the TCAP Opcode Based Routing feature is enabled and but not turned on, continue the procedure with [3](#).

If the TCAP Opcode Based Routing feature is not enabled, continue the procedure by performing one of these steps.

- If the Flexible Linkset Optional Based Routing feature is enabled and turned on, shown by the entry `Flex Lset Optnl Based Rtg` in the `rtrv-ctrl-feat` output, continue the procedure with [2](#).
 - If the Flexible Linkset Optional Based Routing feature is not enabled or turned on, perform [Activating the Flexible Linkset Optional Based Routing Feature](#) to enable and turn on the Flexible Linkset Optional Based Routing feature. After the Flexible Linkset Optional Based Routing feature has been enabled and turned on, continue the procedure with [2](#).
2. Enable the TCAP Opcode Based Routing feature with the `enable-ctrl-feat` command specifying the part number for the TCAP Opcode Based Routing feature and the feature access key. Enter this command.

```
enable-ctrl-feat:partnum=893027801:fak=<TCAP Opcode Based
Routing feature access key>
```

 **Note:**

The TCAP Opcode Based Routing feature cannot be enabled with a temporary feature access key.

 **Note:**

The values for the feature access key (the `fak` parameter) are provided by Oracle. If you do not have the feature access key for the TCAP Opcode Based Routing feature, contact your Oracle Sales Representative or Account Representative.

When the `enable-ctrl-feat` command has successfully completed, this message should appear.

```
rlghncxa03w 09-05-28 21:15:37 GMT EAGLE5 41.0.0
ENABLE-CTRL-FEAT: MASP B - COMPLTD
```

If you wish to turn the TCAP Opcode Based Routing feature on at this time, continue the procedure with [3](#).

If you do not wish to turn the TCAP Opcode Based Routing feature on at this time, continue the procedure with [4](#).

▲ Caution:

If the TCAP Opcode Based Routing feature is not turned on, provisioning for the TCAP Opcode Based Routing feature cannot be performed.

3. Turn the TCAP Opcode Based Routing feature on with the `chg-ctrl-feat` command specifying the part number for the TCAP Opcode Based Routing feature and the `status=on` parameter.

Enter this command.

```
chg-ctrl-feat:partnum=893027801:status=on
```

When the `chg-ctrl-feat` command has successfully completed, this message should appear.

```
rlghncxa03w 09-05-28 21:15:37 GMT EAGLE5 41.0.0
CHG-CTRL-FEAT: MASP B - COMPLTD
```

4. Verify the changes by entering the `rtrv-ctrl-feat` command with the TCAP Opcode Based Routing feature part number. Enter this command.

```
rtrv-ctrl-feat:partnum=893027801
```

The following is an example of the possible output.

```
rlghncxa03w 09-05-28 21:15:37 GMT EAGLE5 41.0.0
The following features have been permanently enabled:
```

Feature Name	Partnum	Status	Quantity
TCAP Opcode Based Routing	893027801	on	----

The following features have been temporarily enabled:

Feature Name	Partnum	Status	Quantity	Trial Period Left
Zero entries found.				

The following features have expired temporary keys:

Feature Name	Partnum
Zero entries found.	

5. Back up the new changes using the `chg-db:action=backup:dest=fixed` command. These messages should appear, the active Maintenance and Administration Subsystem Processor (MASP) appears first.

```
BACKUP (FIXED) : MASP A - Backup starts on active MASP.
BACKUP (FIXED) : MASP A - Backup on active MASP to fixed disk complete.
BACKUP (FIXED) : MASP A - Backup starts on standby MASP.
BACKUP (FIXED) : MASP A - Backup on standby MASP to fixed disk complete.
```

Figure 5-66 Activate the TCAP Opcode Based Routing Feature - Sheet 1 of 2

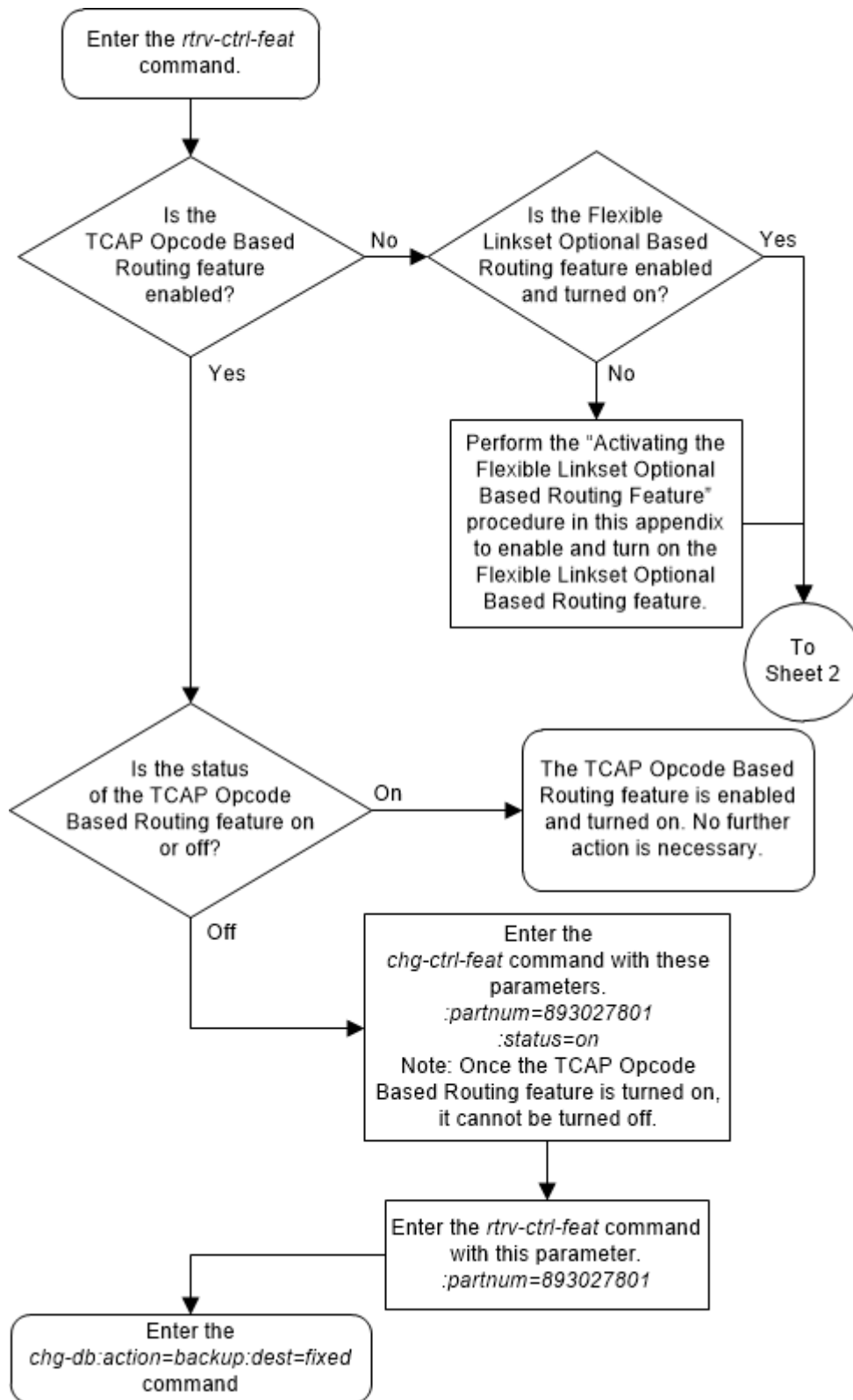
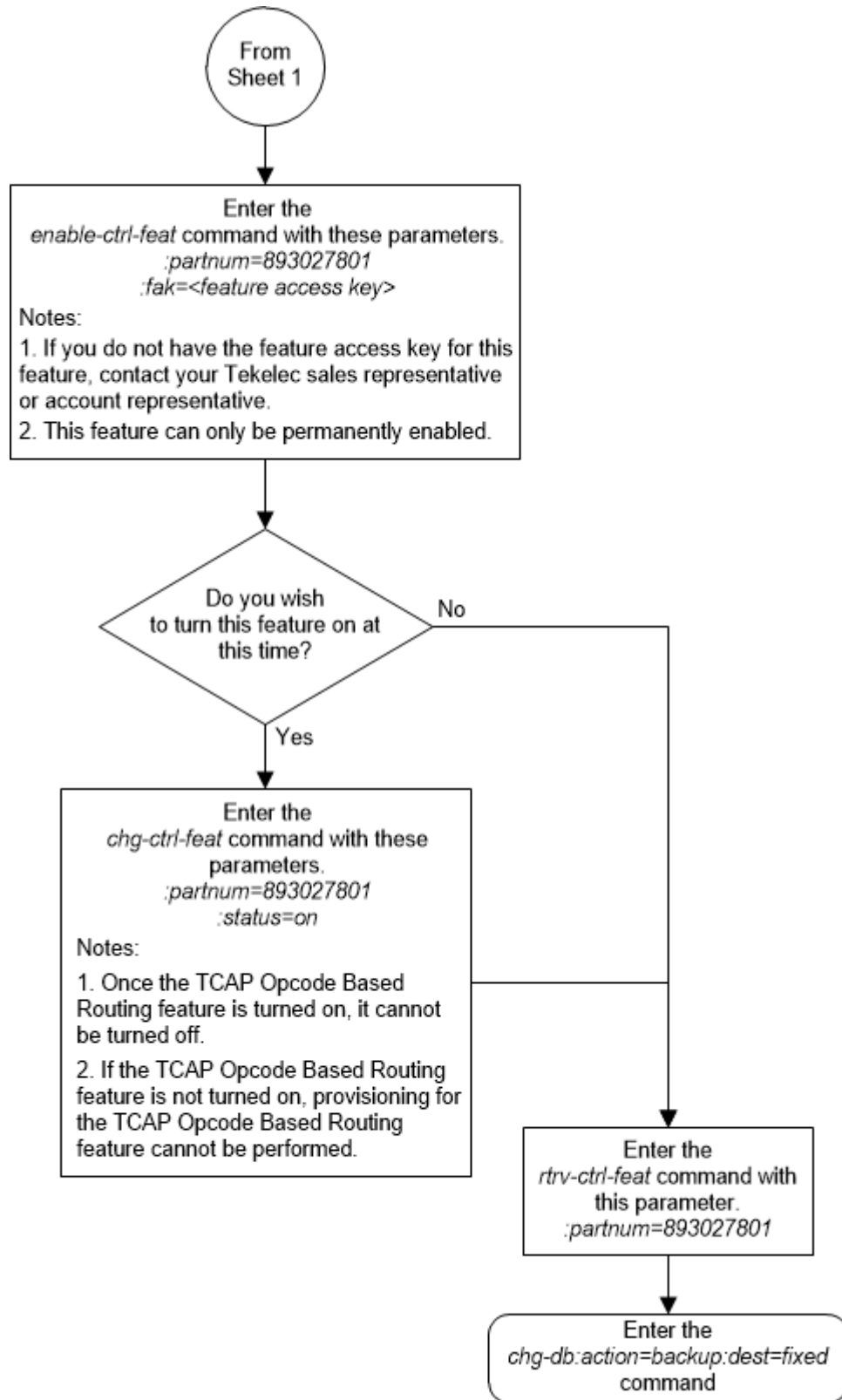

Figure 5-67 Activate the TCAP Opcode Based Routing Feature - Sheet 2 of 2



Enabling a TOBR Opcode Quantity

This procedure is used to enable a TOBR opcode quantity for the TCAP Opcode Based Routing (TOBR) feature. The TOBR opcode quantity is enabled using the feature's part number and a feature access key.

The feature access key for the TOBR opcode quantity is based on the part number for the specific quantity and the serial number of the EAGLE, making the feature access key site-specific.

[Table 5-4](#) shows the TOBR opcode quantities that can be enabled.

Table 5-4 TOBR Opcode Quantity Part Numbers

TOBR Opcode Quantities	Part Numbers
3	893027901
6	893027902
12	893027903
24	893027904
48	893027905
96	893027906
1,000,000	893027907

Note: While the 1,000,000 TOBR opcode quantity can be enabled, the actual number of opcode translations that can be entered is controlled by the XGTT table expansion quantity that is enabled. For example, if the 1,000,000 TOBR opcode quantity is enabled, and the XGTT table expansion quantity is enabled for 400,000, a maximum of 400,000 TOBR opcode translations can be provisioned in the database.

The TCAP Opcode Based Routing feature must be enabled and turned on before a TOBR opcode quantity can be enabled. Perform [Activating the TCAP Opcode Based Routing Feature](#) to enable and turn on the TCAP Opcode Based Routing feature.

The `enable-ctrl-feat` command enables the TOBR opcode quantity by inputting the quantity's feature access key and the part number of the quantity with these parameters.

`:fak` – The feature access key provided by Oracle. The feature access key contains 13 alphanumeric characters and is not case sensitive.

`:partnum` – The Oracle-issued part number of the TOBR Opcode quantity. [Table 5-4](#) shows the TOBR opcode quantity part numbers.

This feature cannot be temporarily enabled (with the temporary feature access key).

The `chg-ctrl-feat` command cannot be used with this procedure.

1. Display the features that are enabled by entering the `rtrv-ctrl-feat` command.

The following is an example of the possible output.

```
rlghncxa03w 09-05-28 21:15:37 GMT EAGLE5 41.0.0
The following features have been permanently enabled:
```

Feature Name	Partnum	Status	Quantity
Command Class Management	893005801	on	----
LNP Short Message Service	893006601	on	----
Intermed GTT Load Sharing	893006901	on	----
XGTT Table Expansion	893006101	off	----
XMAP Table Expansion	893007710	on	3000
Large System # Links	893005910	on	2000
Routesets	893006401	on	6000
HC-MIM SLK Capacity	893012707	on	64

The following features have been temporarily enabled:

Feature Name	Partnum	Status	Quantity	Trial
Period Left				
Zero entries found.				

The following features have expired temporary keys:

Feature Name	Partnum
Zero entries found.	

If the maximum TOBR opcode quantity, 1,000, 000, is enabled, no further action is necessary. This procedure does not need to be performed.

If the TOBR opcode quantity is less than the desired quantity, continue the procedure with [#unique_17](#).

If a TOBR opcode quantity is not enabled, continue the procedure by performing one of these steps.

- If the TCAP Opcode Based Routing feature is enabled and turned on, shown by the entry `TCAP Opcode Based Routing` in this step, continue the procedure with [#unique_17](#).
 - If the TCAP Opcode Based Routing feature is not enabled or turned on, perform [Activating the TCAP Opcode Based Routing Feature](#) to enabled and turn on the TCAP Opcode Based Routing feature. After the TCAP Opcode Based Routing feature has been enabled and turned on, continue the procedure with [#unique_17](#).
2. Enable the TOBR opcode quantity by entering the `enable-ctrl-feat` command with the part number of the desired quantity. shows the TOBR opcode quantity part numbers.

For this example, enter this command.

```
enable-ctrl-feat:partnum=893027903:fak=<TOBR Opcode Quantity
feature access key>
```

 **Note:**

The TOBR opcode quantity enabled in this step must be greater than the quantity that is currently enabled, shown in .

 **Note:**

A temporary feature access key cannot be specified to enable this feature.

 **Note:**

The value for the feature access key (the fak parameter) is provided by Oracle. If you do not have the feature access key for the TOBR opcode quantity that you wish to enable, contact your Oracle Sales Representative or Account Representative.

When the `enable-ctrl-feat` command has successfully completed, this message should appear.

```
rlghncxa03w 09-05-28 21:15:37 GMT EAGLE5 41.0.0
ENABLE-CTRL-FEAT: MASP B - COMPLTD
```

3. Verify the changes by entering the `rtrv-ctrl-feat` command with the part number specified in [#unique_17](#).

For this example, enter this command.

```
rtrv-ctrl-feat:partnum=893027903
```

The following is an example of the possible output.

```
rlghncxa03w 09-05-28 21:15:37 GMT EAGLE5 41.0.0
The following features have been permanently enabled:
```

Feature Name	Partnum	Status	Quantity
TOBR Opcode Quantity	893027903	on	12

The following features have been temporarily enabled:

Feature Name	Partnum	Status	Quantity	Trial
Period Left				
Zero entries found.				

The following features have expired temporary keys:

Feature Name	Partnum
Zero entries found.	

4. Back up the new changes using the `chg-db:action=backup:dest=fixed` command.

These messages should appear, the active Maintenance and Administration Subsystem Processor (MASP) appears first.

```
BACKUP (FIXED) : MASP A - Backup starts on active MASP.
BACKUP (FIXED) : MASP A - Backup on active MASP to fixed disk
complete.
```

BACKUP (FIXED) : MASP A - Backup starts on standby MASP.
 BACKUP (FIXED) : MASP A - Backup on standby MASP to fixed disk complete.

Figure 5-68 Enable a TOBR Opcode Quantity

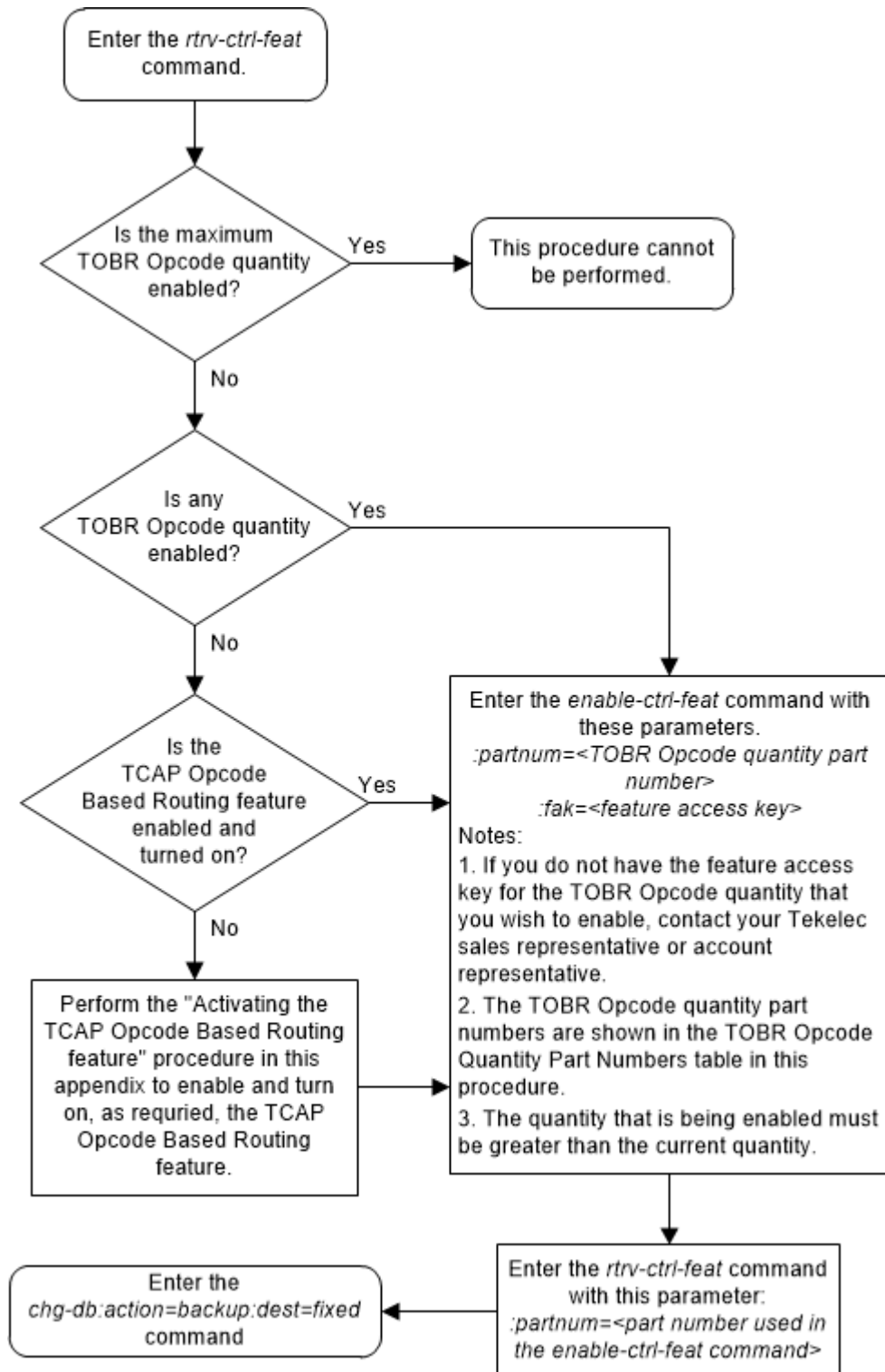

Activating the GTT Actions Features

This procedure is used to enable and turn on one or more of the GTT Actions features using the feature's part number and a feature access key.

There are three GTT Actions features. [Table 5-5](#) shows the feature names and their part numbers.

Table 5-5 GTT Actions Features Part Numbers

GTT Actions Features	Part Number
GTT Action - DISCARD	893027501
GTT Action - DUPLICATE	893027601
GTT Action - FORWARD	893037501

The GTT Actions features are described in the [GTT Actions](#) section.

The feature access key for the GTT Actions features is based on the feature's part number, shown in [Table 5-5](#) and the serial number of the EAGLE, making the feature access key site-specific.

The `enable-ctrl-feat` command enables the feature by inputting the feature's access key and the feature's part number with these parameters:

`:fak` – The feature access key provided by Oracle. The feature access key contains 13 alphanumeric characters and is not case sensitive.

`:partnum` – The Oracle-issued part number of the Advanced GT Modification feature, shown in [Table 5-5](#).

The `enable-ctrl-feat` command requires that the database contain a valid serial number for the EAGLE, and that this serial number is locked. This can be verified with the `rtrv-serial-num` command. The EAGLE is shipped with a serial number in the database, but the serial number is not locked. The serial number can be changed, if necessary, and locked once the EAGLE is on-site, with the `ent-serial-num` command. The `ent-serial-num` command uses these parameters.

`:serial` – The serial number assigned to the EAGLE. The serial number is not case sensitive.

`:lock` – Specifies whether or not the serial number is locked. This parameter has only one value, `yes`, which locks the serial number. Once the serial number is locked, it cannot be changed.

 **Note:**

To enter and lock the EAGLE's serial number, the `ent-serial-num` command must be entered twice, once to add the correct serial number to the database with the `serial` parameter, then again with the `serial` and the `lock=yes` parameters to lock the serial number. You should verify that the serial number in the database is correct before locking the serial number. The serial number can be found on a label affixed to the control shelf (shelf 1100).

These features cannot be temporarily enabled (with the temporary feature access key).

Once the GTT Actions feature has been enabled, the feature must be turned on with the `chg-ctrl-feat` command. The `chg-ctrl-feat` command uses these parameters.

`:partnum` – The Oracle-issued part number of the GTT Actions feature, shown in [Table 5-5](#).

`:status=on` – used to turn the GTT Actions feature on.

Once a GTT Actions feature is turned on, it cannot be turned off.

The status of the features in the EAGLE is shown with the `rtrv-ctrl-feat` command.

Before the GTT Actions features can be enabled, the EGTT feature must be turned on. The state of the EGTT feature can be verified using the `rtrv-feat` command.

1. Display the status of the features in the database by entering the `rtrv-ctrl-feat` command.

The following is an example of the possible output.

```
rlghncxa03w 10-07-28 21:15:37 GMT EAGLE5 42.0.0
The following features have been permanently enabled:
```

Feature Name	Partnum	Status	Quantity
Command Class Management	893005801	on	----
LNP Short Message Service	893006601	on	----
Intermed GTT Load Sharing	893006901	on	----
HC-MIM SLK Capacity	893012707	on	64

The following features have been temporarily enabled:

Feature Name	Partnum	Status	Quantity	Trial
Period Left				
Zero entries found.				

The following features have expired temporary keys:

Feature Name	Partnum
Zero entries found.	

If the desired GTT Actions feature is enabled and turned on, no further action is necessary. This procedure does not need to be performed.

If the desired GTT Actions feature is enabled, but not turned on, continue the procedure with [10](#).

If the desired GTT Actions feature is not enabled, continue the procedure by performing one of these steps.

- If any of these features are enabled, then the EGTT feature is turned on.
 - Origin-based SCCP Routing
 - Flexible Linkset Optional Based Routing
 - MO SMS B-Party Routing
 - Any GTT Actions feature

If any of the features shown in this list are enabled, continue the procedure with [3](#).

- If none of the features shown in the previous list are enabled, continue the procedure with [2](#).
2. Verify the EGTT feature is on, by entering the `rtrv-feat` command. If the EGTT feature is on, the `EGTT` field should be set to `on`.

 **Note:**

The `rtrv-feat` command output contains other fields that are not used by this procedure. If you wish to see all the fields displayed by the `rtrv-feat` command, see the `rtrv-feat` command description in *Commands User's Guide*.

If the EGTT feature is not on, perform the [Adding a Service Module](#) procedure to turn the EGTT feature on and add the appropriate service modules to the EAGLE. The EAGLE cannot contain any in-service SMs if the GTT Action - DUPLICATE feature is being enabled.

If the EGTT feature is on, or after the [Adding a Service Module](#) procedure has been performed, continue the procedure with [3](#).

3. Continue the procedure by performing one of these steps.

No in-service SMs can be provisioned in the database if the GTT Action - DUPLICATE feature is being enabled.

If any of these features are enabled, shown in [1](#), then in-service SMs are not provisioned in the database.

- Support for 16 GTT Lengths in VGTT
- Flexible Linkset Optional Based Routing
- An LNP telephone number quantity that is 240 million numbers or greater.

If any of the features in the previous list are enabled, or if the GTT Action - DUPLICATE feature is not being enabled, continue the procedure by performing one of these steps.

- If the `rtrv-ctrl-feat` output in 1 shows any controlled features, continue the procedure with 9 .
- If the `rtrv-ctrl-feat` output shows only the HC-MIM SLK Capacity feature with a quantity of 64, 5 through 8 must be performed. Continue the procedure with 5.

If none of the features shown in the first list in this step are enabled and the GTT Action - DUPLICATE feature is being enabled, continue the procedure with 4.

4. Verify that no in-service SMs are provisioned in the database using the `rept-stat-card:appl=vsccp` command. This is an example of the possible output.

```
rlghncxa03w 10-07-01 11:40:26 GMT EAGLE5 42.0.0
CARD   VERSION      TYPE      GPL      PST      SST
AST
1101   133-002-000   DSM      VS CCP   IS-NR    Active
-----
1103   133-002-000   DSM      VS CCP   IS-NR    Active
-----
1201   133-002-000   DSM      SC CP HC IS-NR    Active
-----
1203   133-002-000   DSM      SC CP HC IS-NR    Active
-----
1207   133-002-000   DSM      SC CP HC IS-NR    Active
-----
1213   133-002-000   DSM      SC CP HC IS-NR    Active
-----
1215   133-002-000   DSM      SC CP HC IS-NR    Active
-----
1305   133-002-000   DSM      SC CP HC IS-NR    Active
-----
1313   133-002-000   DSM      SC CP HC IS-NR    Active
-----
2103   133-002-000   DSM      SC CP HC IS-NR    Active
-----
Command Completed.
```

A DSM is shown by the entry `VS CCP` in the `GPL` column in the `rept-stat-card` output. The state of the DSM is shown in the `PST` column in the `rept-stat-card` output. If the value in the `PST` column for a DSM is `IS-NR`, the SM is an in-service SM.

If in-service SMs are shown in the `rept-stat-card` output, the in-service SM must be replaced by an E5-SM4G card. Contact [#unique_17](#) before replacing any service modules. Refer to [#unique_17](#) section for the contact information.

After the in-service SMs have been replaced, or if no in-service SMs are shown in the `rept-stat-card` output, continue the procedure by performing one of these steps.

- If the `rtrv-ctrl-feat` output in shows any controlled features, continue the procedure with .
- If the `rtrv-ctrl-feat` output shows only the HC-MIM SLK Capacity feature with a quantity of 64, through must be performed. Continue the procedure with .

5. Display the serial number in the database with the `rtrv-serial-num` command.

This is an example of the possible output.

```
rlghncxa03w 10-07-28 21:15:37 GMT EAGLE5 42.0.0
System serial number = nt00001231
```

System serial number is not locked.

```
rlghncxa03w 10-07-28 21:15:37 GMT EAGLE5 42.0.0
Command Completed.
```

6. Enter the correct serial number into the database using the `ent-serial-num` command with the `serial` parameter.

 **Note:**

If the serial number is correct and locked, continue the procedure with `.`. If the serial number is correct but not locked, continue the procedure with `.`. If the serial number is not correct, but is locked, this feature cannot be enabled and the remainder of this procedure cannot be performed. Contact [#unique_17](#) to get an incorrect and locked serial number changed. Refer to [#unique_17](#) for the contact information. The serial number can be found on a label affixed to the control shelf (shelf 1100).

For this example, enter this command.

```
ent-serial-num:serial=<EAGLE's correct serial number>
```

When this command has successfully completed, the following message should appear.

```
rlghncxa03w 10-07-28 21:15:37 GMT EAGLE5 42.0.0
ENT-SERIAL-NUM: MASP A - COMPLTD
```

7. Verify that the serial number entered in was entered correctly using the `rtrv-serial-num` command.

This is an example of the possible output.

```
rlghncxa03w 10-07-28 21:15:37 GMT EAGLE5 42.0.0
System serial number = nt00001231
```

System serial number is not locked.

```
rlghncxa03w 06-10-28 21:15:37 GMT EAGLE5 38.0.0
Command Completed.
```

If the serial number was not entered correctly, repeat and re-enter the correct serial number.

8. Lock the serial number in the database by entering the `ent-serial-num` command with the serial number shown in `.`, if the serial number shown in is

correct, or with the serial number shown in , if the serial number was changed in , and with the `lock=yes` parameter.

For this example, enter this command.

```
ent-serial-num:serial=<EAGLE's serial number>;lock=yes
```

When this command has successfully completed, the following message should appear.

```
rlghncxa03w 10-07-28 21:15:37 GMT EAGLE5 42.0.0  
ENT-SERIAL-NUM: MASP A - COMPLTD
```

9. Enable the GTT Actions feature with the `enable-ctrl-feat` command specifying the part number for the GTT Actions feature and the feature access key.

The part numbers of the GTT Actions features are shown in .

To enable the GTT Action - DISCARD feature, enter this command.

```
enable-ctrl-feat:partnum=893027501:fak=<GTT Action - DISCARD  
feature access key>
```

To enable the GTT Action - DUPLICATE feature, enter this command.

```
enable-ctrl-feat:partnum=893027601:fak=<GTT Action -  
DUPLICATE feature access key>
```

To enable the GTT Action - FORWARD feature, enter this command.

```
enable-ctrl-feat:partnum=893037501 :fak=<GTT Action - FORWARD  
feature access key>
```

 **Note:**

The values for the feature access key (the `fak` parameter) are provided by Oracle. If you do not have the feature access key for the GTT Actions feature that you wish to enable, contact your Oracle Sales Representative or Account Representative.

When the `enable-ctrl-feat` command has successfully completed, this message should appear.

```
rlghncxa03w 10-07-28 21:15:37 GMT EAGLE5 42.0.0  
ENABLE-CTRL-FEAT: MASP B - COMPLTD
```

If you wish to turn on the GTT Actions feature that was enabled in this step at this time, continue the procedure with .

If you do not wish to turn on the GTT Actions feature that was enabled in this step at this time, continue the procedure with .

10. Turn on the GTT Actions feature that was enabled in by entering the `chg-ctrl-feat` command specifying the part number for the GTT Actions feature and the `status=on` parameter.

To turn the GTT Action - DISCARD feature on, enter this command.

```
chg-ctrl-feat:partnum=893027501:status=on
```

To turn the GTT Action - DUPLICATE feature on, enter this command.

```
chg-ctrl-feat:partnum=893027601:status=on
```

To turn the GTT Action - FORWARD feature on, enter this command.

```
chg-ctrl-feat:partnum=893037501 :status=on
```

When the `chg-ctrl-feat` command has successfully completed, this message should appear.

```
rlghncxa03w 10-07-28 21:15:37 GMT EAGLE5 42.0.0
CHG-CTRL-FEAT: MASP B - COMPLTD
```

- Verify the changes by entering the `rtrv-ctrl-feat` command with the part number used in .

If the GTT Action - DISCARD feature was enabled in , enter this command.

```
rtrv-ctrl-feat:partnum=893027501
```

The following is an example of the possible output.

```
rlghncxa03w 10-07-28 21:15:37 GMT EAGLE5 42.0.0
The following features have been permanently enabled:
```

Feature Name	Partnum	Status	Quantity
GTT Action - DISCARD	893027501	on	----

The following features have been temporarily enabled:

Feature Name	Partnum	Status	Quantity	Trial
Period Left				
Zero entries found.				

The following features have expired temporary keys:

Feature Name	Partnum
Zero entries found.	

If the GTT Action - DUPLICATE feature was enabled in , enter this command.

```
rtrv-ctrl-feat:partnum=893027601
```

The following is an example of the possible output.

```
rlghncxa03w 10-07-28 21:15:37 GMT EAGLE5 42.0.0
The following features have been permanently enabled:
```

Feature Name	Partnum	Status	Quantity
GTT Action - DUPLICATE	893027601	on	----

The following features have been temporarily enabled:

Feature Name	Partnum	Status	Quantity	Trial
Period Left				
Zero entries found.				

The following features have expired temporary keys:

Feature Name	Partnum
Zero entries found.	

If the GTT Action - FORWARD feature was enabled in , enter this command.

```
rtrv-ctrl-feat:partnum=893037501
```

The following is an example of the possible output.

```
rlghncxa03w 10-07-28 21:15:37 GMT EAGLE5 42.0.0
```

The following features have been permanently enabled:

Feature Name	Partnum	Status	Quantity
GTT Action - FORWARD	893037501	on	----

The following features have been temporarily enabled:

Feature Name	Partnum	Status	Quantity	Trial
Period Left				
Zero entries found.				

The following features have expired temporary keys:

Feature Name	Partnum
Zero entries found.	

12. Back up the new changes using the `chg-db:action=backup:dest=fixed` command.

These messages should appear, the active Maintenance and Administration Subsystem Processor (MASP) appears first.

```
BACKUP (FIXED) : MASP A - Backup starts on active MASP.
BACKUP (FIXED) : MASP A - Backup on active MASP to fixed disk
complete.
BACKUP (FIXED) : MASP A - Backup starts on standby MASP.
BACKUP (FIXED) : MASP A - Backup on standby MASP to fixed disk
complete.
```

Figure 5-69 Activate the GTT Actions Features - Sheet 1 of 4

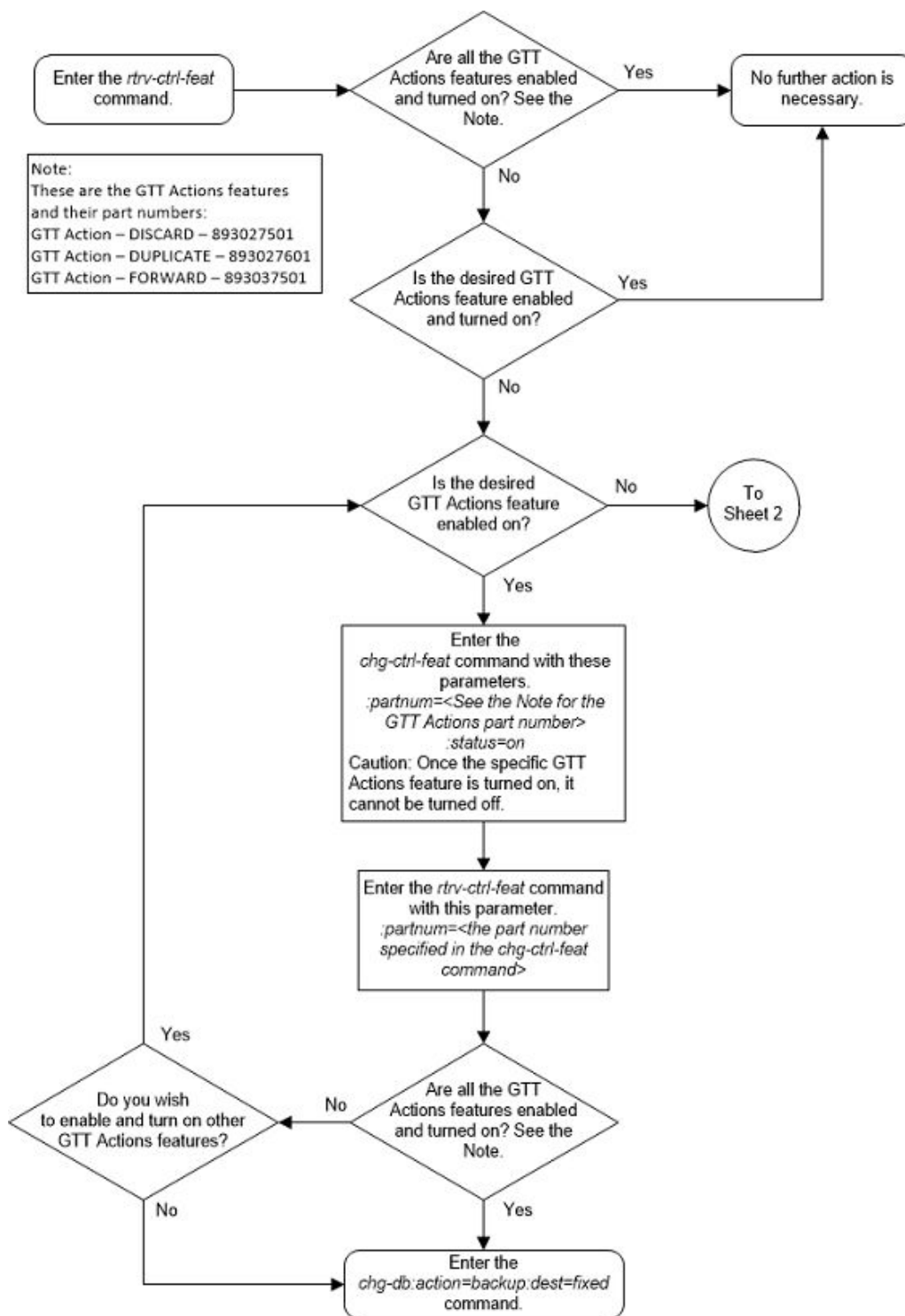

Figure 5-70 Activate the GTT Actions Features - Sheet 2 of 4

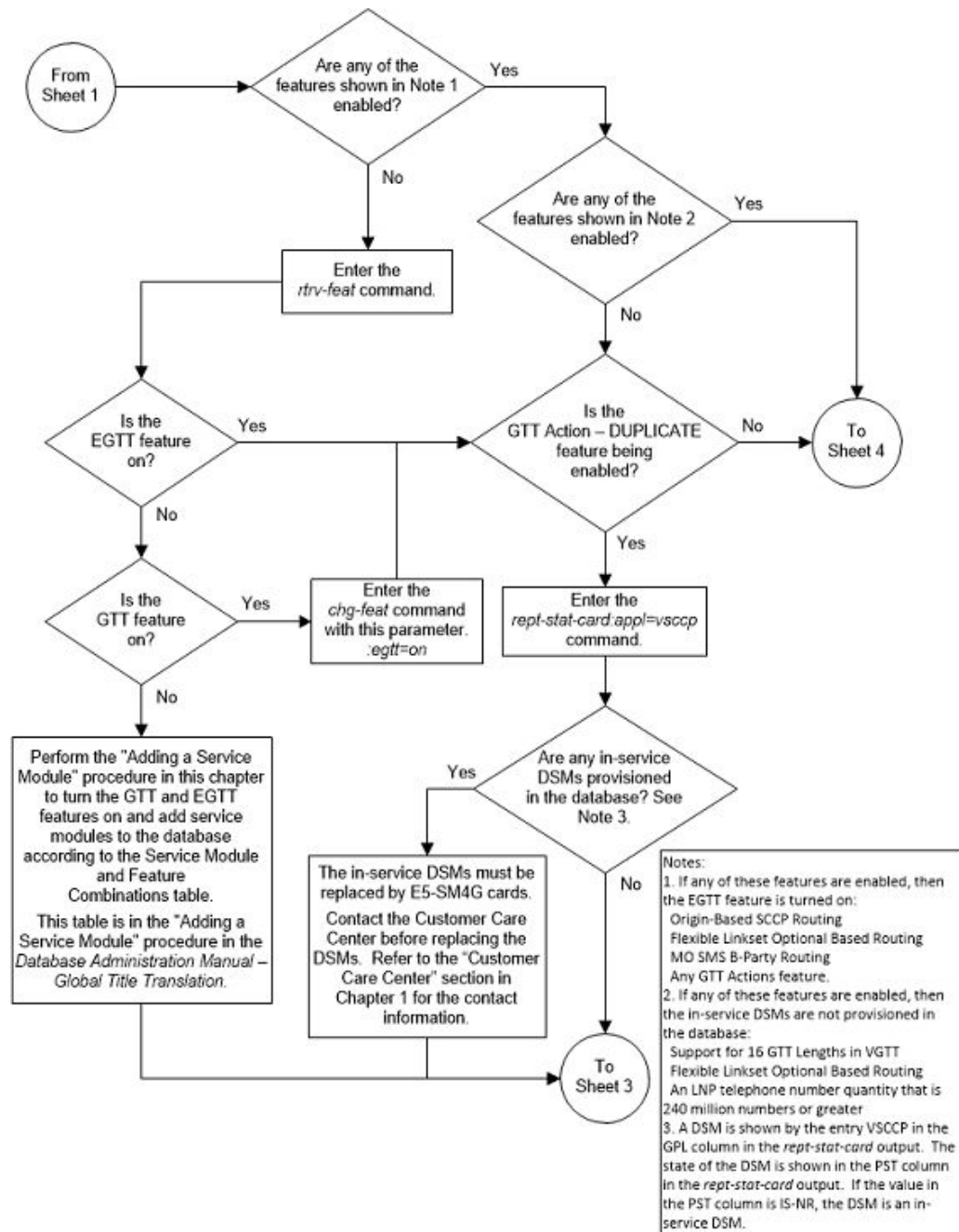

Figure 5-71 Activate the GTT Actions Features - Sheet 3 of 4

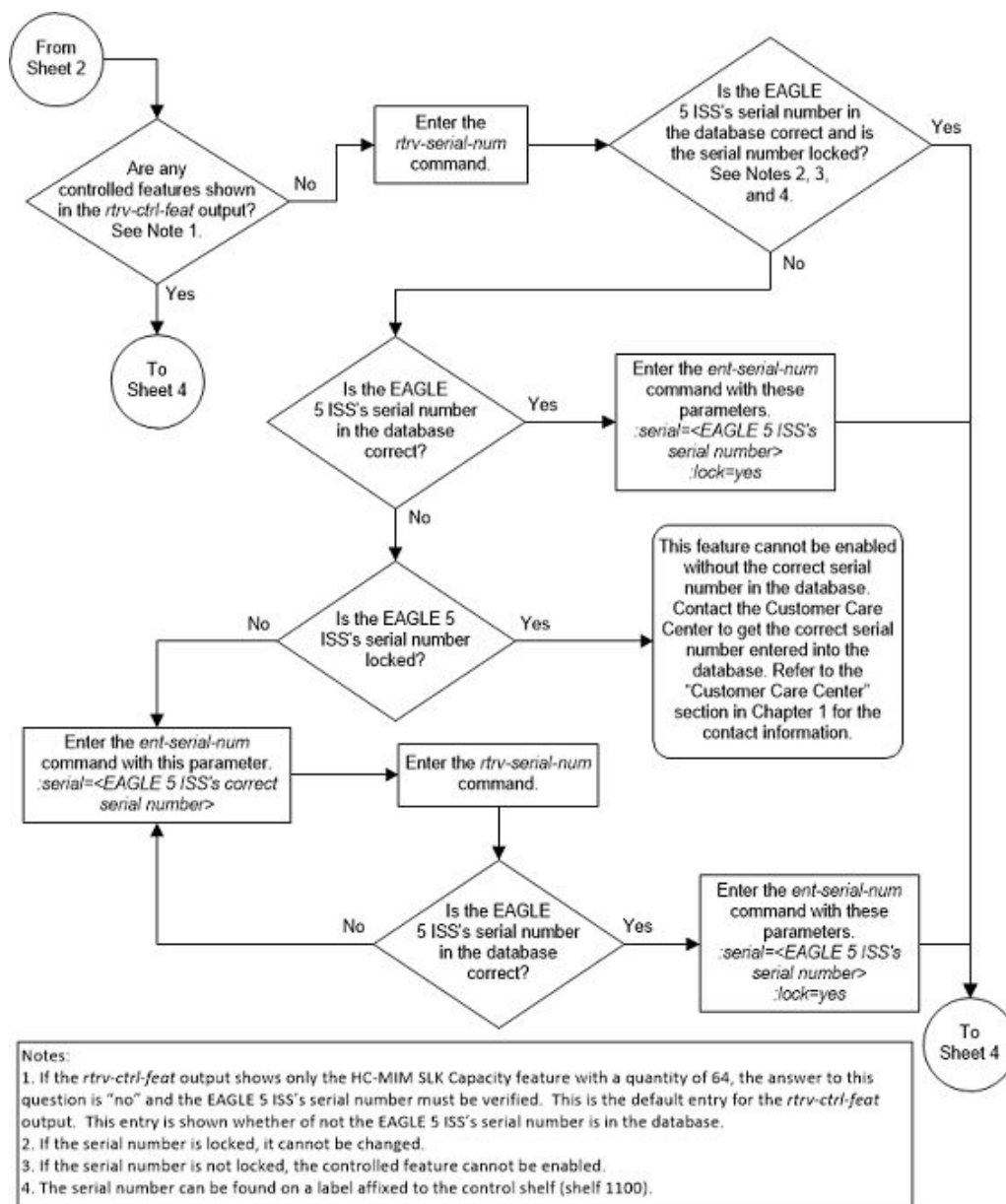
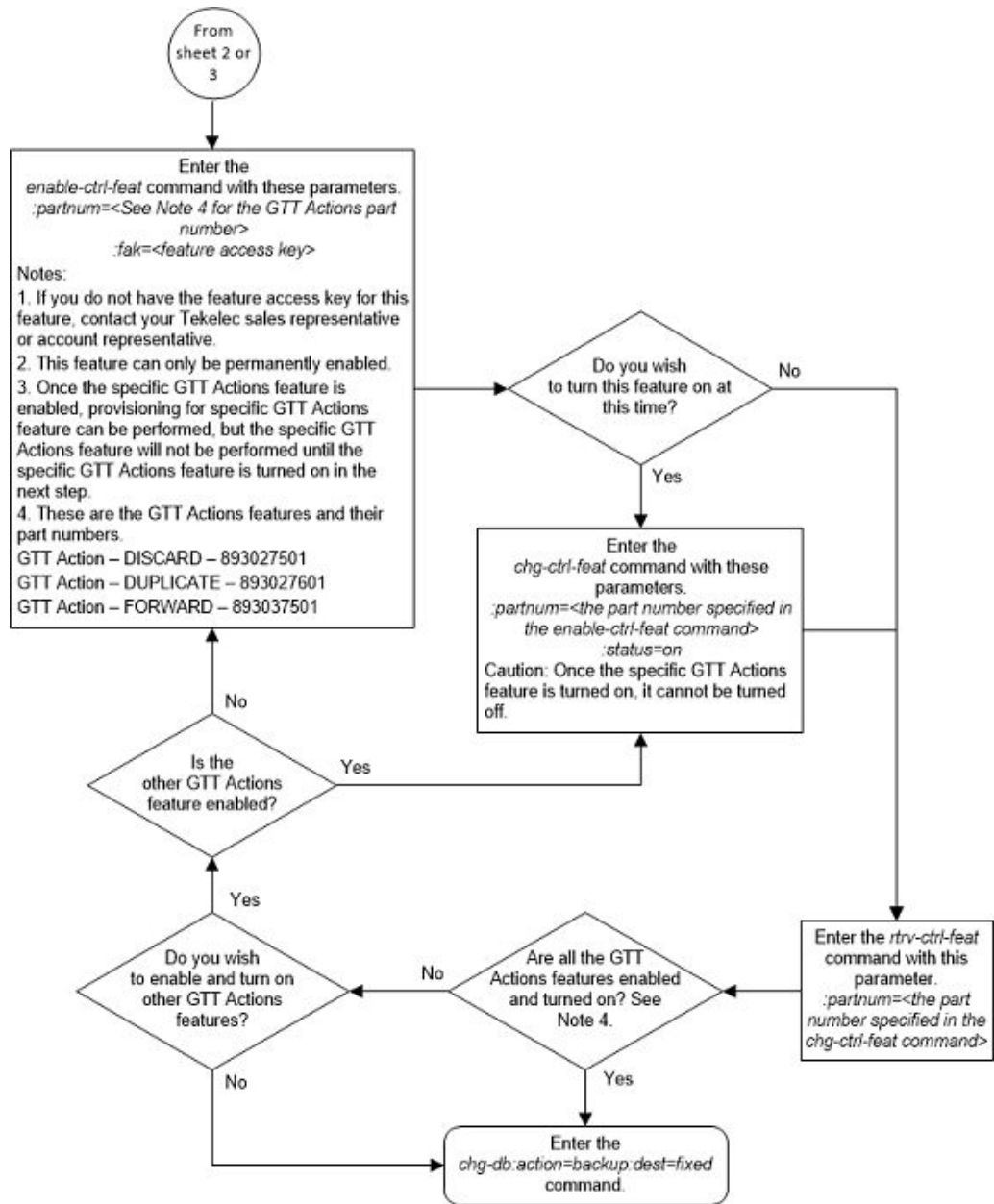

Figure 5-72 Activate the GTT Actions Features - Sheet 4 of 4



Activating the XUDT UDT Conversion Feature

This procedure is used to enable and turn on the XUDT UDT Conversion feature using the feature's part number and a feature access key.

The feature access key for the XUDT UDT Conversion feature is based on the feature's part number and the serial number of the EAGLE, making the feature access key site-specific.

The `enable-ctrl-feat` command enables the feature by inputting the feature's access key and the feature's part number with these parameters.

`:fak` – The feature access key provided by Oracle. The feature access key contains 13 alphanumeric characters and is not case sensitive.

`:partnum` – The Oracle-issued part number of the XUDT UDT Conversion feature, 893035301.

The `enable-ctrl-feat` command requires that the database contain a valid serial number for the EAGLE, and that this serial number is locked. This can be verified with the `rtrv-serial-num` command. The EAGLE is shipped with a serial number in the database, but the serial number is not locked. The serial number can be changed, if necessary, and locked once the EAGLE is on-site, with the `ent-serial-num` command. The `ent-serial-num` command uses these parameters.

`:serial` – The serial number assigned to the EAGLE. The serial number is not case sensitive.

`:lock` – Specifies whether or not the serial number is locked. This parameter has only one value, `yes`, which locks the serial number. Once the serial number is locked, it cannot be changed.



Note:

To enter and lock the EAGLE's serial number, the `ent-serial-num` command must be entered twice, once to add the correct serial number to the database with the `serial` parameter, then again with the `serial` and the `lock=yes` parameters to lock the serial number. You should verify that the serial number in the database is correct before locking the serial number. The serial number can be found on a label affixed to the control shelf (shelf 1100).

This feature cannot be temporarily enabled (with the temporary feature access key).

Once this feature has been enabled, the feature must be turned on with the `chg-ctrl-feat` command. The `chg-ctrl-feat` command uses these parameters.

`:partnum` – The Oracle-issued part number of the XUDT UDT Conversion feature, 893035301.

`:status=on` – used to turn the XUDT UDT Conversion feature on.

Once the XUDT UDT Conversion feature has been turned on, it cannot be turned off.

The status of the features in the EAGLE is shown with the `rtrv-ctrl-feat` command.

1. Display the features that are enabled by entering the `rtrv-ctrl-feat` command. The following is an example of the possible output.

```
rlghncxa03w 10-12-28 21:15:37 GMT EAGLE5 43.0.0
The following features have been permanently enabled:
```

Feature Name	Partnum	Status	Quantity
Command Class Management	893005801	on	----
LNP Short Message Service	893006601	on	----
Intermed GTT Load Sharing	893006901	on	----

```
HC-MIM SLK Capacity      893012707  on      64
```

The following features have been temporarily enabled:

Feature Name	Partnum	Status	Quantity	Trial Period Left
Zero entries found.				

The following features have expired temporary keys:

Feature Name	Partnum
Zero entries found.	

If the XUDT UDT Conversion feature is enabled and turned on, no further action is necessary. This procedure does not need to be performed.

If the XUDT UDT Conversion feature is enabled and but not turned on, continue the procedure with 7.

If the XUDT UDT Conversion feature is not enabled, continue the procedure with 6 if the `rtrv-ctrl-feat` output in 1 shows any controlled features. If the `rtrv-ctrl-feat` output shows only the HC-MIM SLK Capacity feature with a quantity of 64, 2 through 5 must be performed.

2. Display the serial number in the database with the `rtrv-serial-num` command. This is an example of the possible output.

```
rlghncxa03w 10-12-28 21:15:37 GMT EAGLE5 43.0.0
System serial number = nt00001231
```

System serial number is not locked.

```
rlghncxa03w 10-12-28 21:15:37 GMT EAGLE5 43.0.0
Command Completed.
```

Note:

If the serial number is correct and locked, continue the procedure with 6. If the serial number is correct but not locked, continue the procedure with 5. If the serial number is not correct, but is locked, this feature cannot be enabled and the remainder of this procedure cannot be performed. Contact the Customer Care Center to get an incorrect and locked serial number changed. Refer to [#unique_17](#) for the contact information. The serial number can be found on a label affixed to the control shelf (shelf 1100).

3. Enter the correct serial number into the database using the `ent-serial-num` command with the `serial` parameter.

For this example, enter this command.

```
ent-serial-num:serial=<EAGLE's correct serial number>
```

When this command has successfully completed, the following message should appear.

```
rlghncxa03w 10-12-28 21:15:37 GMT EAGLE5 43.0.0
ENT-SERIAL-NUM: MASP A - COMPLTD
```

4. Verify that the serial number entered into was entered correctly using the `rtrv-serial-num` command. This is an example of the possible output.

```
rlghncxa03w 10-12-28 21:15:37 GMT EAGLE5 43.0.0
System serial number = nt00001231
```

System serial number is not locked.

```
rlghncxa03w 10-12-28 21:15:37 GMT EAGLE5 43.0.0
Command Completed.
```

If the serial number was not entered correctly, repeat and re-enter the correct serial number.

5. Lock the serial number in the database by entering the `ent-serial-num` command with the serial number shown in , if the serial number shown in is correct, or with the serial number shown in , if the serial number was changed in , and with the `lock=yes` parameter.

For this example, enter this command.

```
ent-serial-num:serial=<EAGLE's serial number>:lock=yes
```

When this command has successfully completed, the following message should appear.

```
rlghncxa03w 10-12-28 21:15:37 GMT EAGLE5 43.0.0
ENT-SERIAL-NUM: MASP A - COMPLTD
```

6. Enable the XUDT UDT Conversion feature with the `enable-ctrl-feat` command specifying the part number for the XUDT UDT Conversion feature and the feature access key. Enter this command.

```
enable-ctrl-feat:partnum=893035301:fak=<XUDT UDT Conversion
feature access key>
```

 **Note:**

The XUDT UDT Conversion feature cannot be enabled with a temporary feature access key.

 **Note:**

The values for the feature access key (the `fak` parameter) are provided by Oracle. If you do not have the feature access key for the XUDT UDT Conversion feature, contact your Oracle Sales Representative or Account Representative.

When the `enable-ctrl-feat` command has successfully completed, this message should appear.

```
rlghncxa03w 10-12-28 21:15:37 GMT EAGLE5 43.0.0  
ENABLE-CTRL-FEAT: MASP B - COMPLTD
```

If you do not wish to turn the XUDT UDT Conversion feature on at this time, continue the procedure with .

If you wish to turn the XUDT UDT Conversion feature on at this time, continue the procedure with .

▲ Caution:

If the XUDT UDT Conversion feature is not turned on, provisioning for XUDT UDT Conversion cannot be performed.

7. Turn the XUDT UDT Conversion feature on with the `chg-ctrl-feat` command specifying the part number for the XUDT UDT Conversion feature and the `status=on` parameter.

Enter this command.

```
chg-ctrl-feat:partnum=893035301:status=on
```

When the `chg-ctrl-feat` command has successfully completed, this message should appear.

```
rlghncxa03w 10-12-28 21:15:37 GMT EAGLE5 43.0.0  
CHG-CTRL-FEAT: MASP B - COMPLTD
```

8. Verify the changes by entering the `rtrv-ctrl-feat` command with the XUDT UDT Conversion feature part number. Enter this command.

```
rtrv-ctrl-feat:partnum=893035301
```

The following is an example of the possible output.

```
rlghncxa03w 10-12-28 21:15:37 GMT EAGLE5 43.0.0  
The following features have been permanently enabled:
```

Feature Name	Partnum	Status	Quantity
XUDT UDT Conversion	893035301	on	----

The following features have been temporarily enabled:

Feature Name	Partnum	Status	Quantity	Trial
Period Left				
Zero entries found.				

The following features have expired temporary keys:

Feature Name	Partnum
Zero entries found.	

- Back up the new changes using the `chg-db:action=backup:dest=fixed` command. These messages should appear, the active Maintenance and Administration Subsystem Processor (MASP) appears first.

```

BACKUP (FIXED) : MASP A - Backup starts on active MASP.
BACKUP (FIXED) : MASP A - Backup on active MASP to fixed disk
complete.
BACKUP (FIXED) : MASP A - Backup starts on standby MASP.
BACKUP (FIXED) : MASP A - Backup on standby MASP to fixed disk
complete.
  
```

Figure 5-73 Activate the XUDT UDT Conversion Feature - Sheet 1 of 3

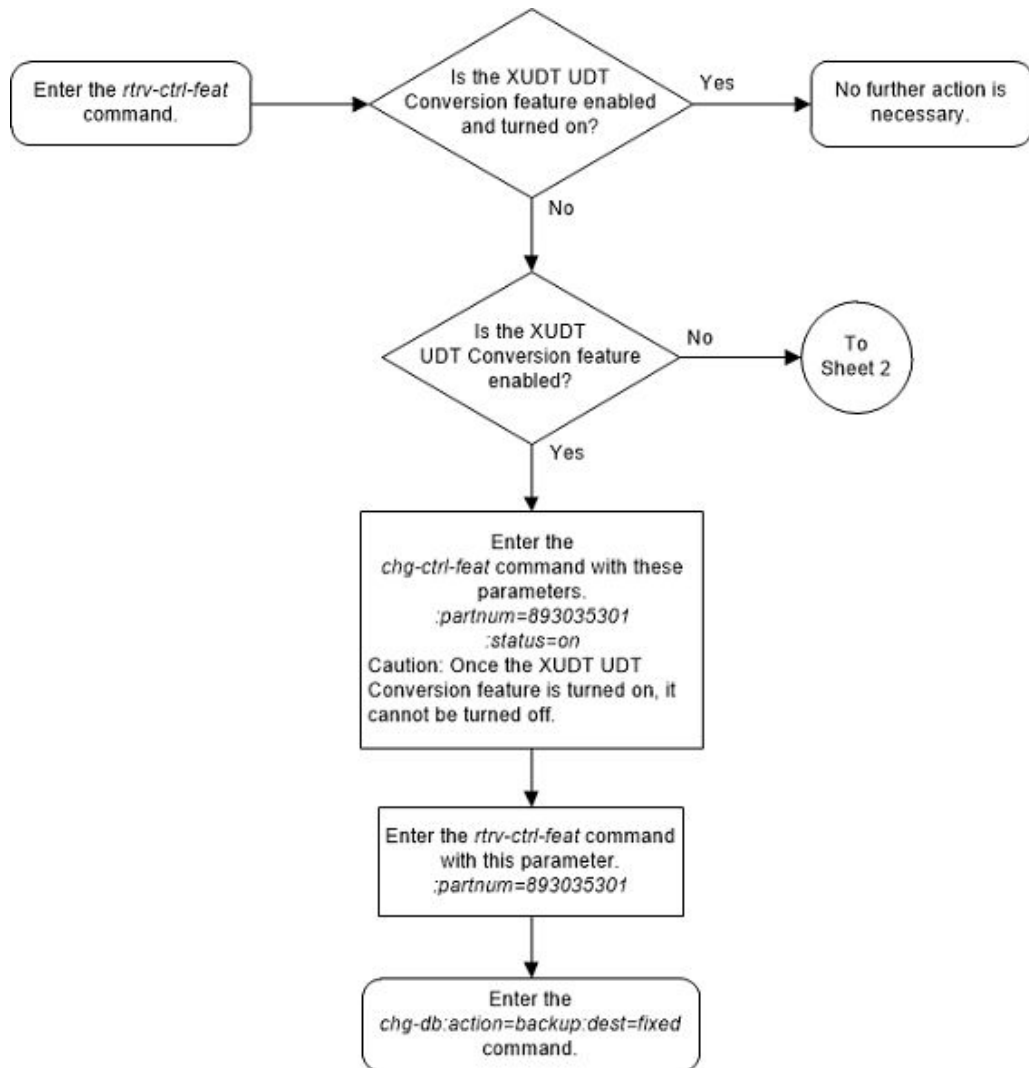

Figure 5-74 Activate the XUDT UDT Conversion Feature - Sheet 2 of 3

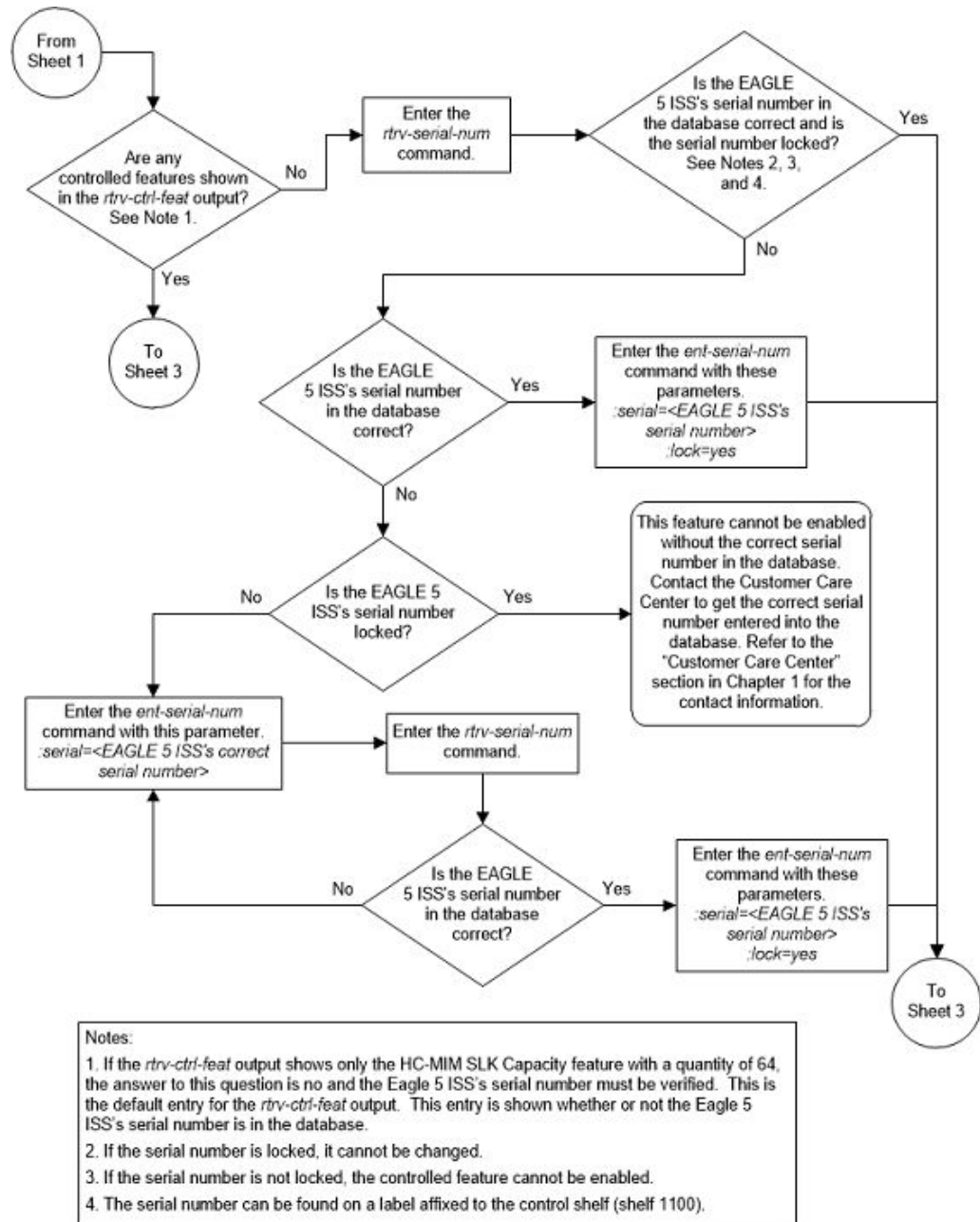
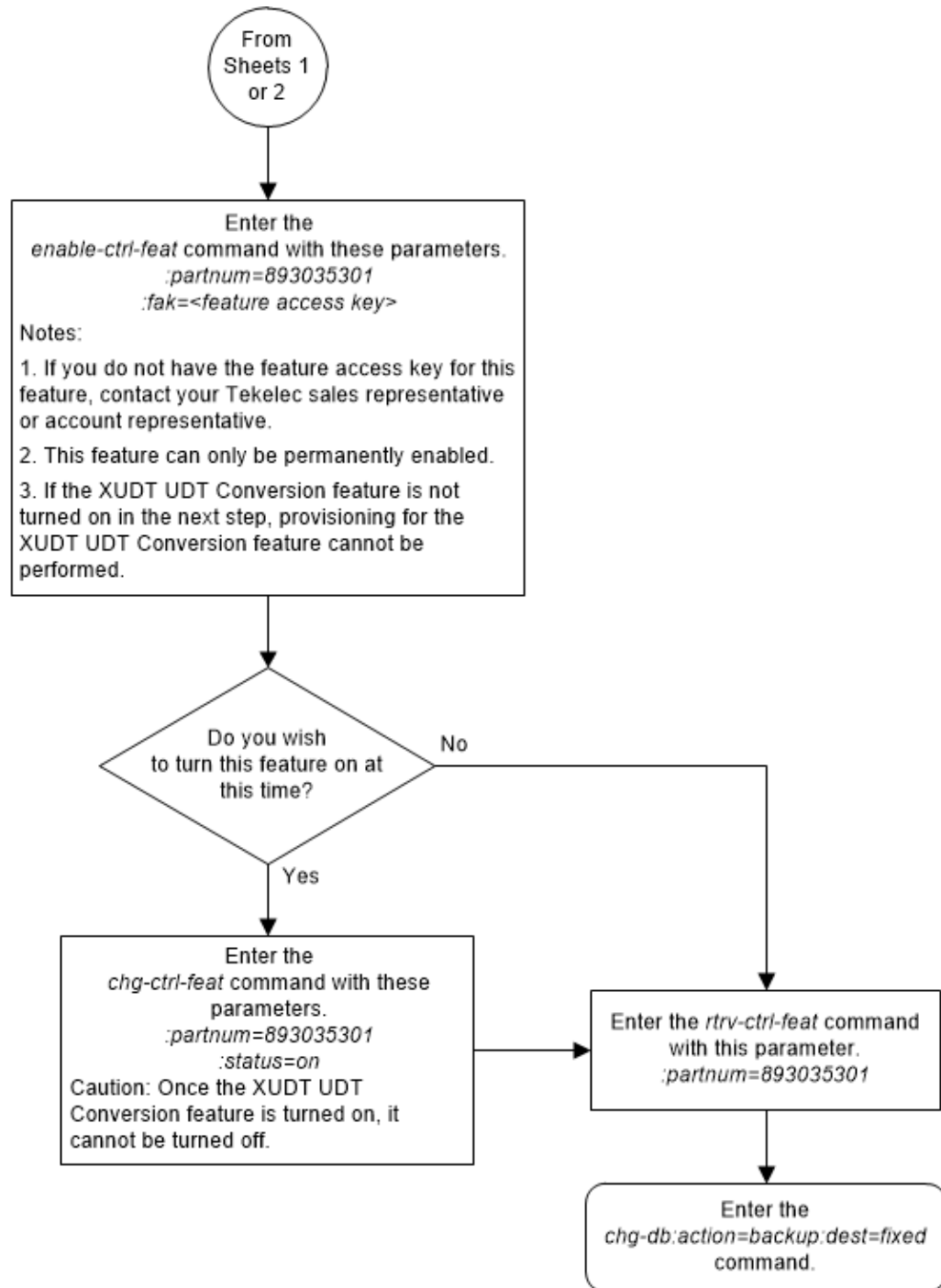

Figure 5-75 Activate the XUDT UDT Conversion Feature - Sheet 3 of 3



A

MO SMS B-Party Routing Configuration Procedures

Appendix B, **MO SMS B-Party Routing Configuration Procedures**, describes the procedures necessary to configure the EAGLE to perform global title translation on the MAP **B-Party** digits instead of the GTT called party address of the message.

Introduction

The MO SMS B-Party Routing feature allows global translation type (GTT) routing to be performed on IS41 MO SMDPP and GSM MO_FSM messages based on the SMS B-party digits from the MAP layer of the message.

If the B number is a short code, then a short message service (SMS) can be directed to a specific short message service center (SMSC) based on the short code dialed by the SMS sender. If the B number is the MSISDN/MDN of the SMS recipient, then the SMS can be directed to a specific SMSC based on subscriber groupings or types.

Provisioning the MO SMS B-Party Routing Feature

1. Enable the MO SMS B-Party Routing feature using the `enable-ctrl-feat` command. Perform the procedure [Activating the MO SMS B-Party Routing Feature](#).

Note:

The MO SMS B-Party Routing feature can be turned on in this step using the `chg-ctrl-feat` command. If the MO SMS B-Party Routing feature is not turned on in this step, provisioning for the MO SMS B-Party Routing feature can still be performed. When the provisioning is completed, the MO SMS B-Party Routing feature can be turned on. The MO SMS B-Party Routing feature will not work until the feature is turned on.

2. Provision a GTT set that will be used by the MO SMS B-Party Routing feature using the `ent-gttset` command. Perform the procedure [Adding a GTT Set](#).
3. Assign the GTT set to the B-Party GTT set name option. Perform one or both of these procedures.
 - If global translation type (GTT) routing will be performed on GSM MO_FSM messages, the GTT set name must be the value of the `bpartygttsn` parameter of the `chg-gsmmsmsopts` command. Perform the procedure [Configuring the GSM MO SMS B-Party Routing Options](#).
 - If global translation type (GTT) routing will be performed on IS41 MO SMDPP messages, the GTT set name must be the value of the `bpartygttsn`

parameter of the `chg-is41smsopts` command. Perform the procedure [Configuring the IS-41 MO SMS B-Party Routing Options](#).

4. Specify that global title translation needs to be performed on the MAP B-Party digits of the message. Perform one or both of these procedures.
 - If global translation type (GTT) routing will be performed on GSM MO_FSM messages, the value `mapbparty` must be specified for the `mosmsgttdig` parameter of the `chg-gsmsmsopts` command. Perform the procedure [Configuring the GSM MO SMS B-Party Routing Options](#).
 - If global translation type (GTT) routing will be performed on IS41 MO SMDPP messages, the value `mapbparty` must be specified for the `mosmsgttdig` parameter of the `chg-is41smsopts` command. Perform the procedure [Configuring the IS-41 MO SMS B-Party Routing Options](#).
5. Provision the service selectors for the MO SMS B-Party Routing feature using the `ent-srvsel` command. Perform the procedure [Adding a Service Selector Entry for the MO SMS B-Party Routing Feature](#).
6. If the MO SMS B-Party Routing feature was not turned on in step 1, turn the feature on using the `chg-ctrl-feat` command. Perform the procedure [Activating the MO SMS B-Party Routing Feature](#).

Activating the MO SMS B-Party Routing Feature

This procedure is used to enable and turn on the MO SMS B-Party Routing feature using the feature's part number.

The `enable-ctrl-feat` command enables the MO SMS B-Party Routing feature by inputting the feature's access key and the feature's part number with these parameters:

`:fak` – The feature access key provided. The feature access key contains 13 alphanumeric characters and is not case sensitive.

`:partnum` – The issued part number of the MO SMS B-Party Routing feature, 893024601.

The `enable-ctrl-feat` command requires that the database contain a valid serial number for the EAGLE, and that this serial number is locked. This can be verified with the `rtrv-serial-num` command. The EAGLE is shipped with a serial number in the database, but the serial number is not locked. The serial number can be changed, if necessary, and locked once the EAGLE is on-site, with the `ent-serial-num` command. The `ent-serial-num` command uses these parameters.

`:serial` – The serial number assigned to the EAGLE. The serial number is not case sensitive.

`:lock` – Specifies whether or not the serial number is locked. This parameter has only one value, `yes`, which locks the serial number. Once the serial number is locked, it cannot be changed.

 **Note:**

To enter and lock the EAGLE's serial number, the `ent-serial-num` command must be entered twice, once to add the correct serial number to the database with the `serial` parameter, then again with the `serial` and the `lock=yes` parameters to lock the serial number. You should verify that the serial number in the database is correct before locking the serial number. The serial number can be found on a label affixed to the control shelf (shelf 1100).

This feature cannot be temporarily enabled (with the temporary feature access key).

Once this feature is enabled, provisioning for this feature can be performed, but the feature will not work until the feature is turned on with the `chg-ctrl-feat` command. The `chg-ctrl-feat` command uses these parameters:

`:partnum` – The issued part number of the MO SMS B-Party Routing feature, 893024601.

`:status=on` – used to turn the MO SMS B-Party Routing feature on.

Once the MO SMS B-Party Routing feature has been turned on, it can be turned off. For more information on turning the MO SMS B-Party Routing feature off, refer to the procedure [Turning the MO SMS B-Party Routing Feature Off](#).

The status of the features in the EAGLE is shown with the `rtrv-ctrl-feat` command.

The MO SMS B-Party Routing feature requires that DSMs or SLIC cards are installed and provisioned in the EAGLE. DSM cards are shown by the entry `dsm` in the `TYPE` column and `vsccp` in the `APPL` column of the `rtrv-card` output. SLIC cards are shown as `type=dsm` (in the odd numbered card slots) or `type=slic` (in the even numbered card slots), and `appl=vsccp`.

The MO SMS B-Party Routing feature also requires that the Global Title Translation (GTT) and Enhanced Global Title Translation (EGTT) features are turned on. The status of the Global Title Translation and Enhanced Global Title Translation features are shown in the `rtrv-feat` output.

1. Display the status of the controlled features by entering the `rtrv-ctrl-feat` command. The following is an example of the possible output.

```
rlghncxa03w 08-09-28 21:15:37 GMT EAGLE5 39.1.0
The following features have been permanently enabled:
```

Feature Name	Partnum	Status	Quantity
Command Class Management	893005801	on	----
LNP Short Message Service	893006601	on	----
Intermed GTT Load Sharing	893006901	on	----
XGTT Table Expansion	893006101	on	400000
XMAP Table Expansion	893007710	off	----
Large System # Links	893005910	on	2000
Routesets	893006401	on	6000
HC-MIM SLK Capacity	893012707	on	64

The following features have been temporarily enabled:

Feature Name	Partnum	Status	Quantity	Trial
Period Left				
Zero entries found.				

The following features have expired temporary keys:

Feature Name	Partnum
Zero entries found.	

If the MO SMS B-Party Routing feature is enabled and turned on, no further action is necessary. This procedure does not need to be performed.

If the MO SMS B-Party Routing is enabled and but not turned on, continue the procedure with [9](#).

If the MO SMS B-Party Routing is not enabled, continue the procedure with [2](#).

2. Display the cards in the EAGLE using the `rtrv-card` command.

The MO SMS B-Party Routing feature requires that DSMs or SLIC cards running the VSCCP application are in the database. The following is an example of the possible output:

```
rlghncxa03w 09-05-25 09:58:31 GMT EAGLE5 41.0.0
CARD   TYPE      APPL      LSET NAME      PORT SLC LSET NAME
PORT SLC
1102   TSM         GLS
1113   E5MCAP     OAMHC
1114   E5TDM-A
1115   E5MCAP     OAMHC
1116   E5TDM-B
1117   E5MDAL
1201   LIMDS0     SS7ANSI   sp2            A    0    sp1
B      0
1203   LIMDS0     SS7ANSI   sp3            A    0
1204   LIMDS0     SS7ANSI   sp3            A    1
1206   LIMDS0     SS7ANSI   nsp3           A    1    nsp4
B      1
1301   DSM        VSCCP
1303   DSM        VSCCP
1305   DSM        VSCCP
1308   LIMDS0     SS7ANSI   sp6            A    1    sp7
B      0
1314   LIMDS0     SS7ANSI   sp7            A    1    sp5
B      1
```

There are two types of cards that run the VSCCP application: DSMs and SLIC.

DSM cards are shown by the entry `dsm` in the `TYPE` column and `vscpp` in the `APPL` column of the `rtrv-card` output. SLIC cards are shown as `type=dsm` (in the odd numbered card slots) or `type=slic` (in the even numbered card slots), and `appl=vscpp`.

If DSMs or SLIC cards running the VSCCP application are in the EAGLE, continue the procedure with [3](#).

If no service modules are shown in the `rtrv-card` output, perform [Adding a Service Module](#) to add DSMs cards to the EAGLE. Make sure to turn the EGTT feature on while performing [Adding a Service Module](#). After [Adding a Service Module](#) has been performed, continue the procedure with [4](#).

 **Note:**

If the `rtrv-ctrl-feat` output in [1](#) shows any controlled features, continue the procedure with [EAGLE](#). If the `rtrv-ctrl-feat` output shows only the HC-MIM SLK Capacity feature with a quantity of 64, [4](#) through [7](#) must be performed.

3. The Enhanced Global Title Translation (EGTT) feature must be turned on to enable the MO SMS B-Party Routing feature. Verify the status of the EGTT feature by entering the `rtrv-feat` command.

If the EGTT feature is on, the EGTT field should be set to `on`.

 **Note:**

The `rtrv-feat` command output contains other fields that are not used by this procedure. If you wish to see all the fields displayed by the `rtrv-feat` command, refer to the `rtrv-feat` command description in *Commands User's Guide*.

If the EGTT feature is on, shown by the entry `EGTT = on` in the `rtrv-feat` command output, continue the procedure with [4](#).

If the EGTT feature is off, shown by the entry `EGTT = off` in the `rtrv-feat` command output, turn the EGTT feature on by entering this command.

```
chg-feat:egtt=on
```

 **Note:**

Once the Enhanced Global Title Translation (EGTT) feature is turned on with the `chg-feat` command, it cannot be turned off. The EGTT feature must be purchased before turning it on. If you are not sure whether you have purchased the EGTT feature, contact your Sales Representative or Account Representative.

When the `chg-feat` has successfully completed, this message should appear.

```
rlghncxa03w 08-09-25 09:57:41 GMT EAGLE5 39.1.0  
CHG-FEAT: MASP A - COMPLTD
```

After the EGTT feature has been turned on, continue the procedure with [4](#).

 **Note:**

If the `rtrv-ctrl-feat` output in 1 shows any controlled features, continue the procedure with 8. If the `rtrv-ctrl-feat` output shows only the HC-MIM SLK Capacity feature with a quantity of 64, 4 through 7 must be performed.

4. Display the serial number in the database with the `rtrv-serial-num` command. This is an example of the possible output.

```
rlghncxa03w 08-09-28 21:15:37 GMT EAGLE5 39.1.0
System serial number = nt00001231
```

System serial number is not locked.

```
rlghncxa03w 08-09-28 21:15:37 GMT EAGLE5 39.1.0
Command Completed.
```

 **Note:**

If the serial number is correct and locked, continue the procedure with 8. If the serial number is correct but not locked, continue the procedure with 7. If the serial number is not correct, but is locked, this feature cannot be enabled and the remainder of this procedure cannot be performed. Contact My Oracle Support to get an incorrect and locked serial number changed. Refer to [#unique_17](#) for the contact information. The serial number can be found on a label affixed to the control shelf (shelf 1100).

5. Enter the correct serial number into the database using the `ent-serial-num` command with the `serial` parameter.

For this example, enter this command.

```
ent-serial-num:serial=<EAGLE's correct serial number>
```

When this command has successfully completed, the following message should appear.

```
rlghncxa03w 08-09-28 21:15:37 GMT EAGLE5 39.1.0
ENT-SERIAL-NUM: MASP A - COMPLTD
```

6. Verify that the serial number entered into was entered correctly using the `rtrv-serial-num` command. This is an example of the possible output.

```
rlghncxa03w 08-09-28 21:15:37 GMT EAGLE5 39.1.0
System serial number = nt00001231
```

System serial number is not locked.

```
rlghncxa03w 08-09-28 21:15:37 GMT EAGLE5 39.1.0
Command Completed.
```

If the serial number was not entered correctly, repeat and re-enter the correct serial number.

7. Lock the serial number in the database by entering the `ent-serial-num` command with the serial number shown in , if the serial number shown in is correct, or with the serial number shown in , if the serial number was changed in , and with the `lock=yes` parameter.

For this example, enter this command.

```
ent-serial-num:serial=<EAGLE's serial number>:lock=yes
```

When this command has successfully completed, the following message should appear.

```
rlghncxa03w 08-09-28 21:15:37 GMT EAGLE5 39.1.0
ENT-SERIAL-NUM: MASP A - COMPLTD
```

8. Enable the MO SMS B-Party Routing feature with the `enable-ctrl-feat` command specifying the part number for the MO SMS B-Party Routing feature. Enter this command.

```
enable-ctrl-feat:partnum=893024601
```

 **Note:**

The MO SMS B-Party Routing feature cannot be enabled with a temporary feature access key.

When the `enable-ctrl-feat` command has successfully completed, this message should appear.

```
rlghncxa03w 08-09-28 21:15:37 GMT EAGLE5 39.1.0
ENABLE-CTRL-FEAT: MASP B - COMPLTD
```

 **Caution:**

Once the MO SMS B-Party Routing feature is enabled, provisioning for MO SMS B-Party Routing feature can be performed, but the EAGLE will not perform global title translation on the MAP B-Party digits of any messages until the MO SMS B-Party Routing is turned on in .

If you wish to turn the MO SMS B-Party feature on at this time, continue the procedure with .

If you do not wish to turn the MO SMS B-Party feature on at this time, continue the procedure with .

9. Turn the MO SMS B-Party Routing feature on with the `chg-ctrl-feat` command specifying the part number for the MO SMS B-Party Routing feature and the `status=on` parameter. Enter this command.

```
chg-ctrl-feat:partnum=893024601:status=on
```

When this command has successfully completed, the following message should appear.

```
rlghncxa03w 08-09-28 21:15:37 GMT EAGLE5 39.1.0
CHG-CTRL-FEAT: MASP B - COMPLTD
```

10. Verify the changes by entering the `rtrv-ctrl-feat` command with the MO SMS B-Party Routing feature part number. Enter this command.

```
rtrv-ctrl-feat:partnum=893024601
```

The following is an example of the possible output.

```
rlghncxa03w 08-09-28 21:15:37 GMT EAGLE5 39.1.0
The following features have been permanently enabled:
```

Feature Name	Partnum	Status	Quantity
MO SMS B-Party Routing	893024601	on	----

The following features have been temporarily enabled:

Feature Name	Partnum	Status	Quantity	Trial Period Left
Zero entries found.				

The following features have expired temporary keys:

Feature Name	Partnum
Zero entries found.	

11. Back up the new changes using the `chg-db:action=backup:dest=fixed` command. These messages should appear, the active Maintenance and Administration Subsystem Processor (MASP) appears first.

```
BACKUP (FIXED) : MASP A - Backup starts on active MASP.
BACKUP (FIXED) : MASP A - Backup on active MASP to fixed disk
complete.
BACKUP (FIXED) : MASP A - Backup starts on standby MASP.
BACKUP (FIXED) : MASP A - Backup on standby MASP to fixed disk
complete.
```

Figure A-1 Activate the MO SMS B-Party Routing Feature- Sheet 1 of 3

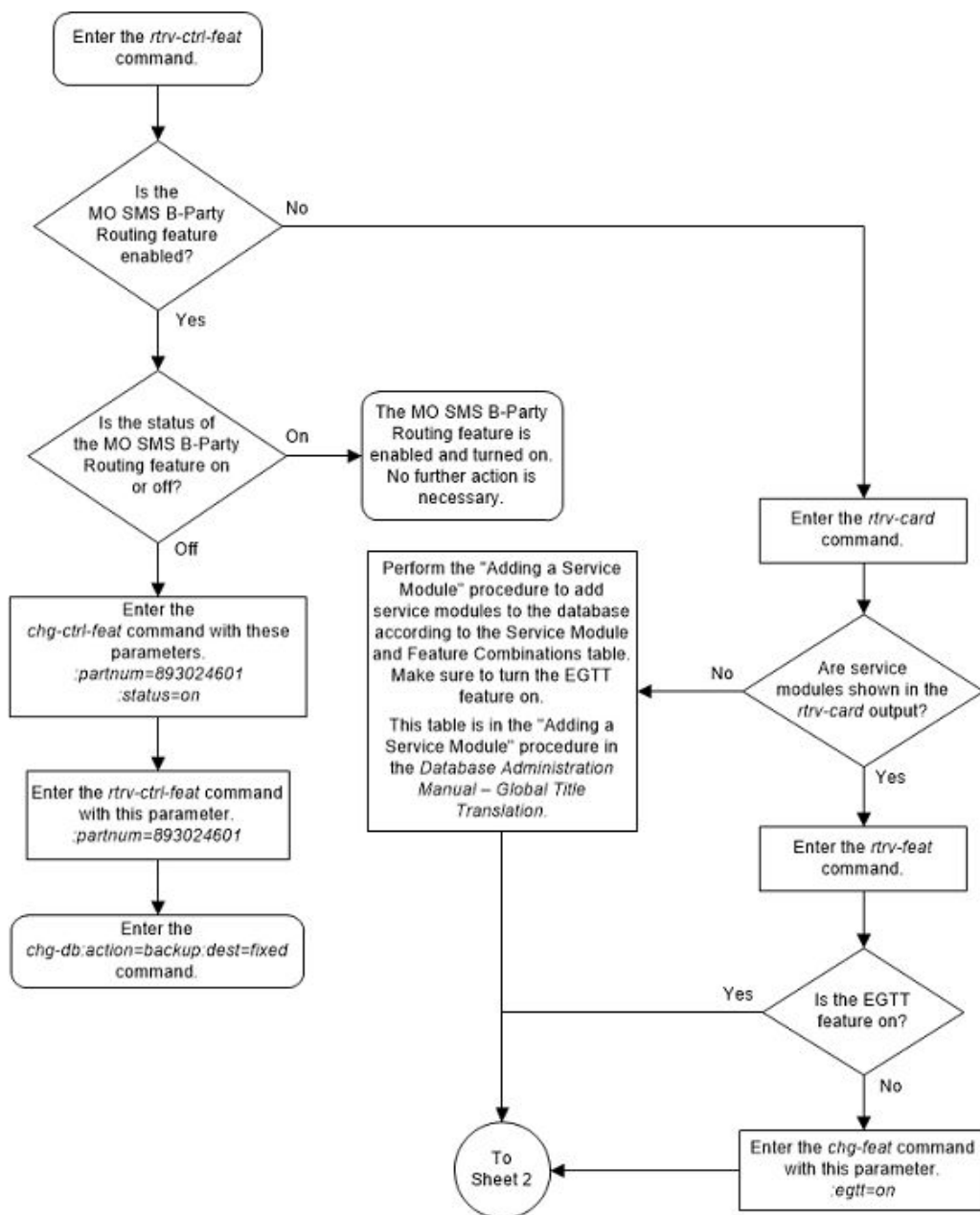

Figure A-2 Activate the MO SMS B-Party Routing Feature - Sheet 2 of 3

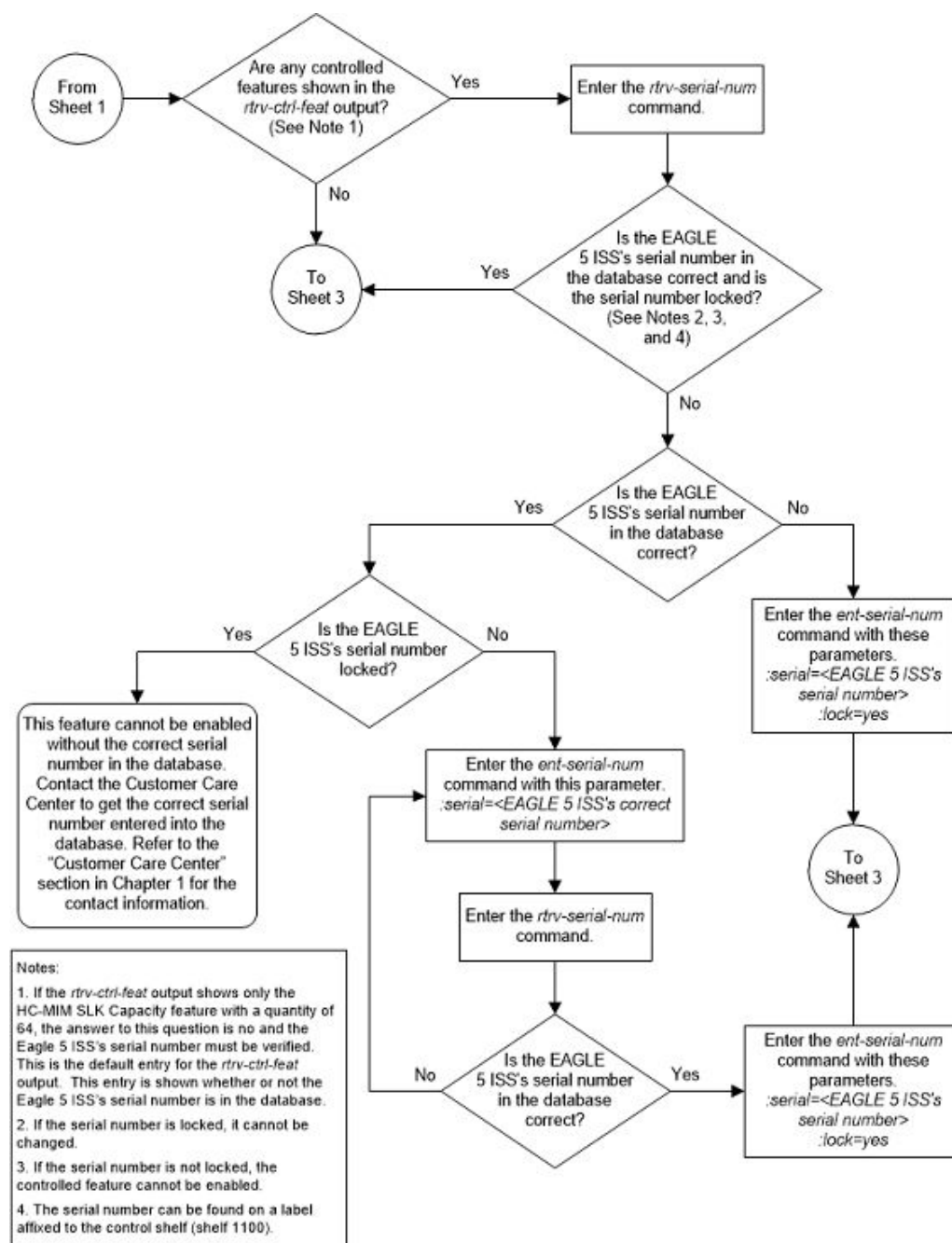
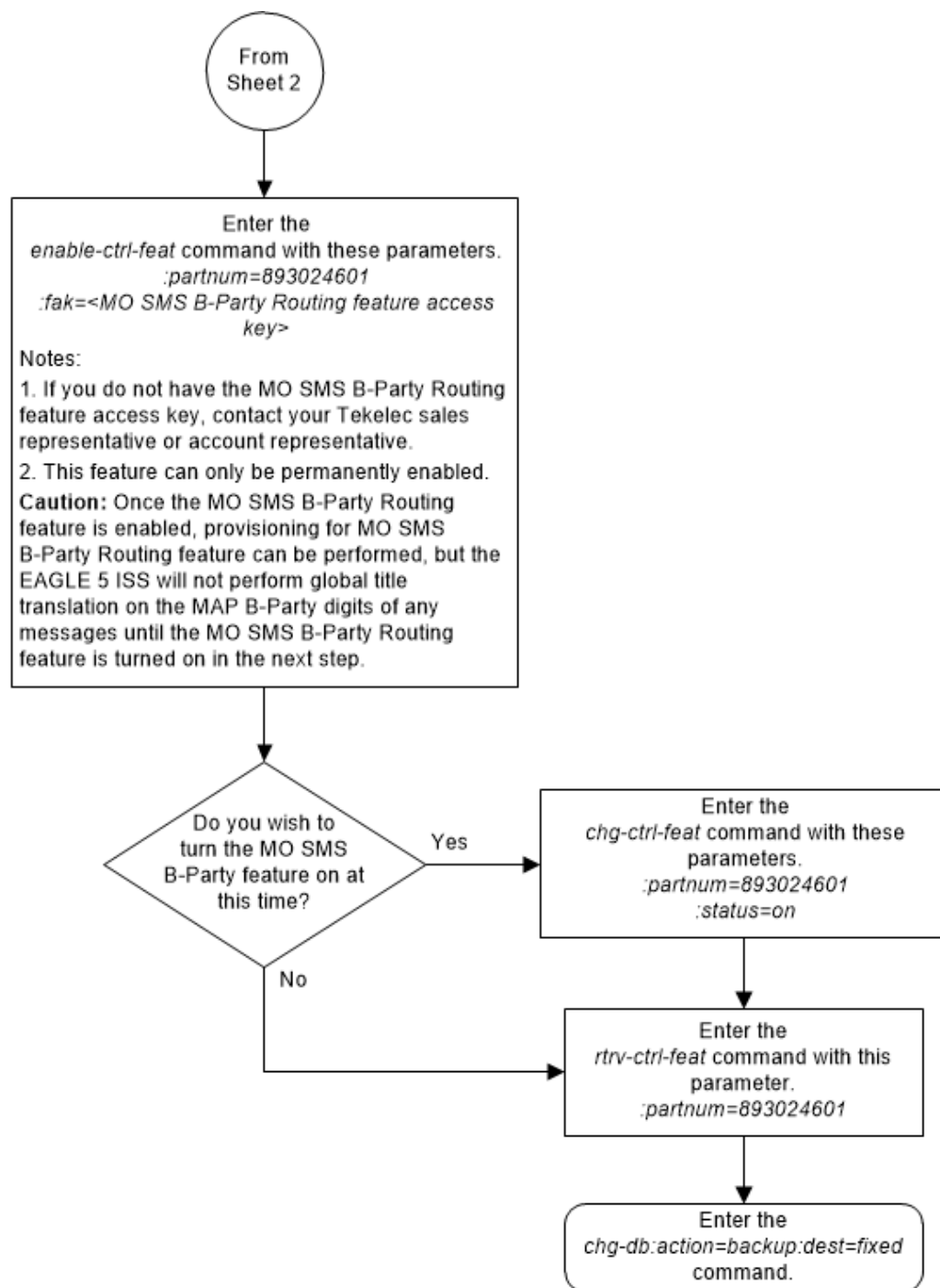

Figure A-3 Activate the MO SMS B-Party Routing Feature - Sheet 3 of 3



Configuring the GSM MO SMS B-Party Routing Options

This procedure is used to configure the MO SMS B-Party routing options for GSM messages using the `chg-gsmsmsopts` command with these parameters:

`:bpartygttsn` – the name of the GTT set, shown in the `rtrv-gttset` output, global title translation on the MAP B-Party digits of the GSM message will be performed on; or the value `none` indicating that global title translation on the MAP B-Party digits of the GSM message will not be performed on any GTT set.

`:mosmsgtttdig` – the digits that are used for global title translation.

- `sccpcdpa` - the digits of the SCCP called party address portion of the message are used for global title translation.
- `mapbparty` - the MAP B-party number is used for global title translation.

The system default value for the `bpartygttsn` parameter is `none`. The system default value for the `mosmsgtttdig` parameter is `sccpcdpa`.

This procedure can be performed only if the MO SMS B-Party Routing feature is enabled.

The set type of the GTT set name that will be specified for the `bpartygttsn` parameter must be `CDGTA`. The set type of the GTT set is shown in the `SETTYPE` column of the `rtrv-gttset` output. If the `SETTYPE` column is not shown in the `rtrv-gttset` output, all the GTT sets are `CDGTA` GTT sets.

If the value of the `bpartygttsn` parameter is `none` when this procedure is completed, the value of the `mosmsgtttdig` parameter must be `sccpcdpa`.

1. Display the existing GSM MO SMS B-Party routing option values by entering the `rtrv-gsmsmsopts` command.

This is an example of the possible output.

```
rlghncxa03w 09-07-28 21:15:37 GMT EAGLE5 41.1.0
GSM SMS OPTIONS
-----
BPARTYGTTSN   = NONE           MOSMSGTTDIG   = SCCPCDPA
```

 **Note:**

The `rtrv-gsmsmsopts` command output contains other fields that are not used by this procedure. If you wish to see all the fields displayed by the `rtrv-gsmsmsopts` command, refer to the `rtrv-gsmsmsopts` command description in the *Commands Manual*.

If the `BPARTYGTTSN` and `MOSMSGTTDIG` fields are not shown in the `rtrv-gsmsmsopts` output, the MO SMS B-Party Routing feature is not enabled. Perform the procedure [Activating the MO SMS B-Party Routing Feature](#) to enable the MO SMS B-Party Routing feature.

If the `BPARTYGTTSN` and `MOSMSGTTDIG` fields are shown in the `rtrv-gsmsmsopts` output, the MO SMS B-Party Routing feature was enabled in this step, continue the procedure by performing one of these actions.

- If a GTT set name will be specified, continue the procedure with [2](#).
- If a GTT set name will not be specified, only the `mosmsgtttdig` parameter value will be changed, continue the procedure with [3](#).

 **Note:**

The `mosmsgttdig` parameter value can be `mapbparty` only if a GTT set name is specified for the `bpartygttsn` parameter value.

2. Display the GTT sets in the database using the `rtrv-gttset` command.

This is an example of the possible output.

```
rlghncxa03w 09-07-07 00:29:31 GMT EAGLE5 41.1.0
```

GTTSN	NETDOM	SETTYPE	NDGT
abcd1234	itu	CGGTA	12
gttset3	ansi	CGGTA	10
gttset6	ansi	OPC	-
gttset7	ansi	CGPC	-
gttset12	ansi	OPC	-
imsi	itu	CDGTA	15
lidb	ansi	CDGTA	10
t800	ansi	CDGTA	10
s1000	itu	CDGTA	15
s2000	itu	CGPC	-

```
GTT-SET table is (10 of 2000) 1% full.
```

The `SETTYPE` column is shown in the `rtrv-gttset` output only if the Origin-Based SCCP Routing feature or if the Flexible Linkset Optional Based Routing feature is enabled and turned on. The `SETTYPE` value of the GTT set name specified for the `bpartygttsn` parameter must be `CDGTA` if the Origin-Based SCCP Routing feature or if the Flexible Linkset Optional Based Routing feature is enabled and turned on. If the `SETTYPE` column is not shown in the `rtrv-gttset` output, all the GTT sets are `CDGTA` GTT sets.

If the required GTT set name is not shown in the `rtrv-gttset` output, perform [Adding a GTT Set](#) to add the required GTT set. After the new GTT set has been added to the database, continue the procedure with [3](#).

3. Configure the GSM MO SMS B-Party Routing options using the `chg-gsmsmsopts` command.

For this example, enter this command.

```
chg-gsmsmsopts:bpartygttsn=s1000:mosmsgttdig=mapbparty
```

When the `chg-gsmsmsopts` command has successfully completed, this message should appear.

```
rlghncxa03w 08-09-07 00:22:57 GMT EAGLE5 39.1.0
CHG-GSMSMSOPTS: MASP A - COMPLTD
```

4. Verify the changes using the `rtrv-gsmsmsopts` command. This is an example of the possible output.

```
rlghncxa03w 09-07-28 21:15:37 GMT EAGLE5 41.1.0
GSM SMS OPTIONS
```

```
-----  
BPARTYGTTSN = s1000          MOSMSGTTDIG = MAPBPARTY
```

5. Back up the new changes using the `chg-db:action=backup:dest=fixed` command. These messages should appear, the active Maintenance and Administration Subsystem Processor (MASP) appears first.

```
BACKUP (FIXED) : MASP A - Backup starts on active MASP.  
BACKUP (FIXED) : MASP A - Backup on active MASP to fixed disk  
complete.  
BACKUP (FIXED) : MASP A - Backup starts on standby MASP.  
BACKUP (FIXED) : MASP A - Backup on standby MASP to fixed disk  
complete.
```

Figure A-4 Configure the GSM MO SMS B-Party Routing Options

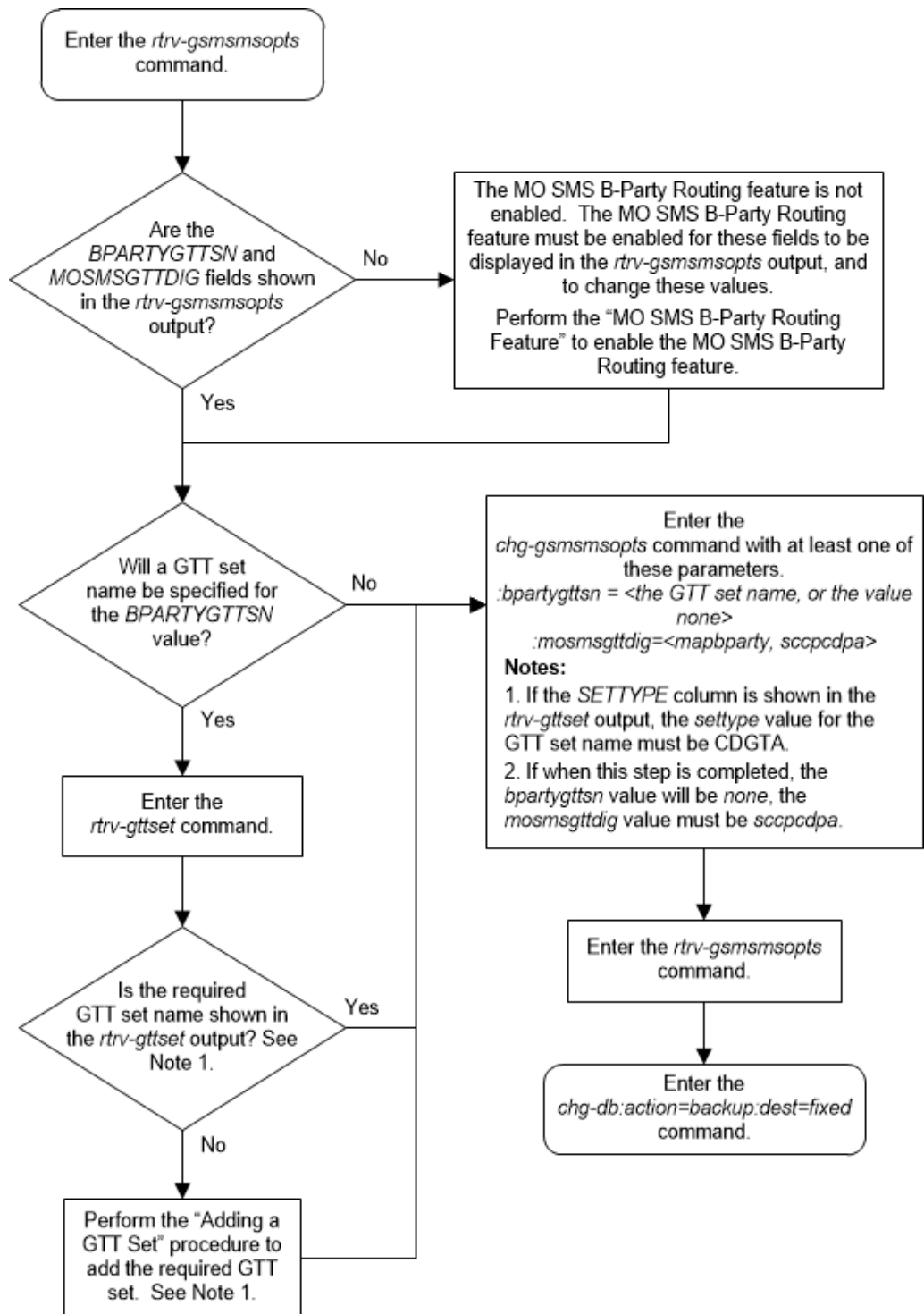

Configuring the IS-41 MO SMS B-Party Routing Options

This procedure is used to configure the MO SMS B-Party routing options for IS-41 messages using the `chg-is41smsopts` command with these parameters:

`:bpartygttsn` – the name of the GTT set, shown in the `rtrv-gttset` output, global title translation on the MAP B-Party digits of the IS-41 message will be performed on; or the value `none` indicating that global title translation on the MAP B-Party digits of the IS-41 message will not be performed on any GTT set.

`:mosmsgtttdig` – the digits that are used for global title translation.

- `sccpcdpa` - the digits of the SCCP called party address portion of the message are used for global title translation.
- `mapbparty` - the MAP B-party number is used for global title translation.

The system default value for the `bpartygttsn` parameter is `none`. The system default value for the `mosmsgtttdig` parameter is `sccpcdpa`.

This procedure can be performed only if the MO SMS B-Party Routing feature is enabled.

The set type of the GTT set name that will be specified for the `bpartygttsn` parameter must be `CDGTA`. The set type of the GTT set is shown in the `SETTYPE` column of the `rtrv-gttset` output. If the `SETTYPE` column is not shown in the `rtrv-gttset` output, all the GTT sets are `CDGTA` GTT sets.

If the value of the `bpartygttsn` parameter is `none` when this procedure is completed, the value of the `mosmsgtttdig` parameter must be `sccpcdpa`.

1. Display the existing IS-41 MO SMS B-Party routing option values by entering the `rtrv-is41smsopts` command.

This is an example of the possible output.

```
rlghncxa03w 09-09-28 21:15:37 GMT EAGLE5 41.1.0
IS41 SMS OPTIONS
-----
BPARTYGTTSN      = NONE
MOSMSGTTDIG     = SCCPCDPA
```

 **Note:**

The `rtrv-is41smsopts` command output contains other fields that are not used by this procedure. If you wish to see all the fields displayed by the `rtrv-is41smsopts` command, refer to the `rtrv-is41smsopts` command description in the *Commands Manual*.

If the `BPARTYGTTSN` and `MOSMSGTTDIG` fields are not shown in the `rtrv-is41smsopts` output, the MO SMS B-Party Routing feature is not enabled. Perform the procedure [Activating the MO SMS B-Party Routing Feature](#) to enable the MO SMS B-Party Routing feature.

If the `BPARTYGTTSN` and `MOSMSGTTDIG` fields are shown in the `rtrv-is41smsopts` output, the MO SMS B-Party Routing feature was enabled in this step, continue the procedure by performing one of these actions.

- If a GTT set name will be specified, continue the procedure with [2](#).
- If a GTT set name will not be specified, only the `mosmsgtttdig` parameter value will be changed, continue the procedure with [3](#).

 **Note:**

The `mosmsgttdig` parameter value can be `mapbparty` only if a GTT set name is specified for the `bpartygttsn` parameter value.

2. Display the GTT sets in the database using the `rtrv-gttset` command.

This is an example of the possible output.

```
rlghncxa03w 09-07-07 00:29:31 GMT EAGLE5 41.1.0
```

GTTSN	NETDOM	SETTYPE	NDGT
abcd1234	itu	CGGTA	12
gttset3	ansi	CGGTA	10
gttset6	ansi	OPC	-
gttset7	ansi	CGPC	-
gttset12	ansi	OPC	-
imsi	itu	CDGTA	15
lidb	ansi	CDGTA	10
t800	ansi	CDGTA	10
s1000	itu	CDGTA	15
s2000	itu	CGPC	-

GTT-SET table is (10 of 2000) 1% full.

The `SETTYPE` column is shown in the `rtrv-gttset` output only if the Origin-Based SCCP Routing feature or if the Flexible Linkset Optional Based Routing feature is enabled and turned on. The `SETTYPE` value of the GTT set name specified for the `bpartygttsn` parameter must be `CDGTA` if the Origin-Based SCCP Routing feature or if the Flexible Linkset Optional Based Routing feature is enabled and turned on. If the `SETTYPE` column is not shown in the `rtrv-gttset` output, all the GTT sets are `CDGTA` GTT sets.

If the required GTT set name is not shown in the `rtrv-gttset` output, perform [Adding a GTT Set](#) to add the required GTT set. After the new GTT set has been added to the database, continue the procedure with [3](#).

3. Configure the IS-41 MO SMS B-Party Routing options using the `chg-is41smsopts` command.

For this example, enter this command.

```
chg-is41smsopts:bpartygttsn=s1000:mosmsgttdig=mapbparty
```

When the `chg-is41smsopts` command has successfully completed, this message should appear.

```
rlghncxa03w 08-09-07 00:22:57 GMT EAGLE5 39.1.0
CHG-IS41SMSOPTS: MASP A - COMPLTD
```

4. Verify the changes using the `rtrv-is41smsopts` command. This is an example of the possible output.

```
rlghncxa03w 09-09-28 21:15:37 GMT EAGLE5 41.1.0
IS41 SMS OPTIONS
```

```
-----  
BPARTYGTTSN      = s1000  
MOSMSGTTDIG      = MAPBPARTY
```

5. Back up the new changes using the `chg-db:action=backup:dest=fixed` command. These messages should appear, the active Maintenance and Administration Subsystem Processor (MASP) appears first.

```
BACKUP (FIXED) : MASP A - Backup starts on active MASP.  
BACKUP (FIXED) : MASP A - Backup on active MASP to fixed disk  
complete.  
BACKUP (FIXED) : MASP A - Backup starts on standby MASP.  
BACKUP (FIXED) : MASP A - Backup on standby MASP to fixed disk  
complete.
```

Figure A-5 Configure the IS-41 MO SMS B-Party Routing Options

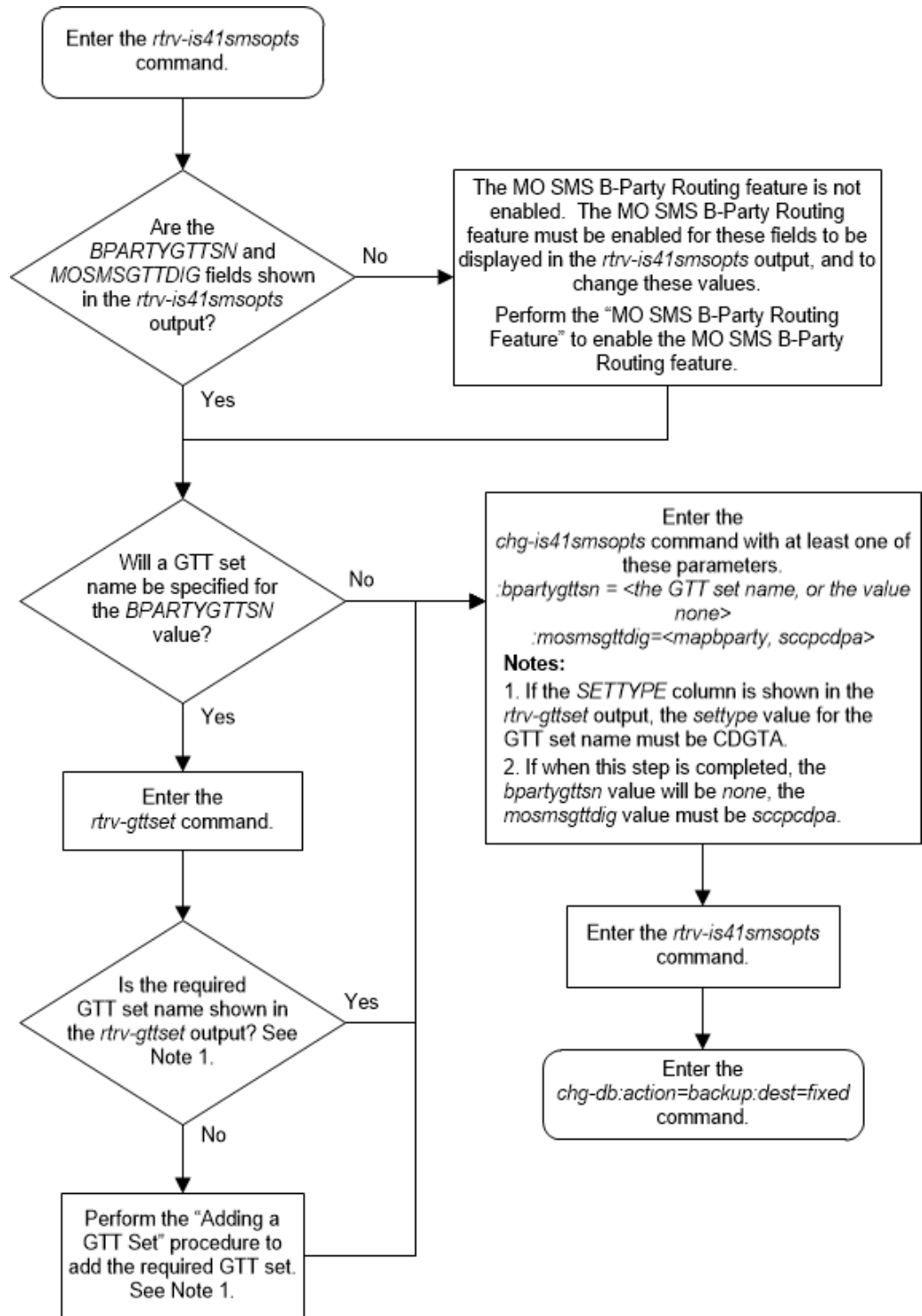

Adding a Service Selector Entry for the MO SMS B-Party Routing Feature

This procedure is used to provision an entry in the service selector table for the MO SMS B-Party Routing feature using the `ent-srvsel` command.

The `ent-srvsel` command uses these parameters.

`:gti/gtia/gtii/gtin/gtin24` – The global title indicator. The GTI defines the domain as

- `gti` and `gtia` (ANSI) with GTI=2
- `gtii` (ITU international) with GTI=2 or GTI=4, and
- `gtin` and `gtin24` (ITU national) with GTI=2 or GTI=4.

The `gti` and `gtia` parameters are equivalent.

`:serv` – the DSM service - `smsmr`.

`:tt` – The global title translation. (0-255)

`:ssn` – The subsystem number. (0-255, or *)

`:dfltact` - The default action identifier that is associated with the service selector entry. This parameter has one of these values.

- A GTT action identifier shown in the `rtrv-gttact` output whose ACTION value is either `disc`, `udts`, or `tcaperr`.
- `fallback` - Fallback to the relay data. The relayed MSU is routed according to the routing data provided by the service.
- `falltoggtt` - Fallback to GTT. If the `gttselid` parameter has a value other than `none`, and the GTT selector search fails, the GTT selector search is performed again using the `gttselid=none` parameter.

`:on=gttrqd` - Global title translation is required after the service execution is complete and the message is relayed by the service.

`:off=gttrqd` - Global title translation is not required after the service execution is complete and the message is relayed by the service.

`:gttselid` - The GTT selector ID user for performing global title translation on messages that are relayed by the service. (0 - 65534)

`:nai` or `:naiv` – The nature of address indicator. See [Table A-1](#) for NAI/NAIV.

Note:

The nature of address indicator parameters (`naiv` or `nai`) can be specified by supplying either a mnemonic or an explicit value. At no time may both the mnemonic and the explicit value be specified at the same time for the same parameter. You can specify either the `naiv` or `nai` parameter. [Table A-1](#) shows the mapping between the `naiv` and the `nai` parameters.

:np or :npv – The numbering plan. See [Table A-2](#) for NP/NPV mapping.

 **Note:**

The numbering plan parameters (npv or np) can be specified by supplying either a mnemonic or an explicit value. At no time may both the mnemonic and the explicit value be specified at the same time for the same parameter. You can specify either the npv or np parameter. [Table A-2](#) shows the mapping between the npv and the np parameters.

:snai – The service nature of address indicator.

- natl — National significant number
- intl — International number
- rnidn — Routing number prefix and international dialed/directory number
- rnndn — Routing number prefix and national dialed/directory number
- rnsdn — Routing number prefix and subscriber dialed/directory number
- ccrndn — Country code, routing number, and national directory number
- sub — Subscriber number

:snp – The service numbering plan - e164

Table A-1 NAIV/NAI Mapping

NAIV	NAI	Description
0	--	Unknown
1	Sub	Subscriber Number
2	Rsvd	Reserved for national use
3	Natl	National significant number
4	Intl	International number
5-127	---	Spare

Table A-2 NPV/NP Mapping

NPV	NP	Description
0	--	Unknown
1	E164	ISDN/telephony numbering plan
2	Generic	Generic numbering plan
3	X121	Data numbering plan
4	F69	Telex numbering plan
5	E210	Maritime mobile numbering plan
6	E212	Land mobile numbering plan
7	E214	ISDN/mobile numbering plan
8	Private	Private network or network-specific numbering plan

Table A-2 (Cont.) NPV/NP Mapping

NPV	NP	Description
9-15	---	Spare

To perform this procedure, the MO SMS B-Party Routing feature must be enabled. Enter the `rtrv-ctrl-feat` command with the MO SMS B-Party Routing part number, 893024601, to verify whether or not the MO SMS B-Party Routing feature is enabled. If the MO SMS B-Party Routing feature is not enabled, perform the procedure [Activating the MO SMS B-Party Routing Feature](#) to enable MO SMS B-Party Routing feature.

ITU service selectors (defined by either the `gtii`, `gtin`, or `gtin24` parameters) can be specified only if the ANSIGFLEX STP option is not enabled. Enter the `rtrv-stpopts` command to verify whether or not the ANSIGFLEX STP option is enabled.

1. Verify the status of the MO SMS B-Party Routing feature by entering the `rtrv-ctrl-feat` command with the MO SMS B-Party Routing feature part number. Enter this command.

```
rtrv-ctrl-feat:partnum=893024601
```

The following is an example of the possible output.

```
rlghncxa03w 08-09-28 21:15:37 GMT EAGLE5 39.1.0
The following features have been permanently enabled:
```

Feature Name	Partnum	Status	Quantity
MO SMS B-Party Routing	893024610	on	----

The following features have been temporarily enabled:

Feature Name	Partnum	Status	Quantity	Trial
Period Left				
Zero entries found.				

The following features have expired temporary keys:

Feature Name	Partnum
Zero entries found.	

If the MO SMS B-Party Routing feature has not been enabled, perform the procedure [Activating the MO SMS B-Party Routing Feature](#) procedure to enable this feature.

2. Display the service selector entries by entering this command `rtrv-srvsel` command.

```
rtrv-srvsel:num=20992:force=yes
```

The following is an example of the possible output.

```
rlghncxa03w 10-07-28 21:15:37 GMT EAGLE5 42.0.0

GTIA TT NP NAI SSN SNP SNAI SERV GTRQD
```

```

2      9      --      ---      *      e212  intl  gflex  off
DFLTACT=fallback GTTSELID=9
2     10      --      ---      3      e164  intl  gflex  off
DFLTACT=fallback GTTSELID=75
2    253      --      ---      4      e214  natl  gflex  off
DFLTACT=fallback GTTSELID=80

GTII  TT  NP      NAI  SSN  SNP  SNAI  SERV  GTTRQD
2     0      --      ---      2      e164  intl  gflex  off
DFLTACT=fallback GTTSELID=56
2     18      --      ---      *      e164  rnsdn  inpmr  on
DFLTACT=fallback GTTSELID=80
4     0      e214  sub  *      e214  sub   gflex  off
DFLTACT=fallback GTTSELID=98

GTIN  TT  NP      NAI  SSN  SNP  SNAI  SERV  GTTRQD
2     2      --      ---      3      e164  intl  gflex  off
DFLTACT=fallback GTTSELID=8
2     9      --      --      *      ---   ---   inpq   ---
DFLTACT=----- GTTSELID=-----
4     2      e164  natl *      e164  rnndn  inpmr  on
DFLTACT=fallback GTTSELID=432
4     9      ---      ---      4      ---   ---   inpq   ---
DFLTACT=----- GTTSELID=-----

SRV_SELECTOR table is (10 of 20992)  1 % full

```

Note:

If the `rtrv-srvsel` command is entered with no other parameters specified, a maximum of 50 entries are displayed. To display more than 50 entries, the `force=yes` parameter must be specified with the `rtrv-srvsel` command and the `num` parameter value must be greater than 50. Since there can be a maximum of 20992 service selectors in the database, to display all the service selectors in the database, the `force=yes` and `num=20992` parameters must be specified with the `rtrv-srvsel` command.

If the number of service selector entries is 20992, the new service selector entry cannot be added unless an existing service selector entry is removed from the database, or an existing service selector entry is changed with the new information for the MO SMS B-Party Routing feature.

Continue the procedure by performing one of these actions.

- If the number of service selector entries is 20992 and you wish to change an existing service selector entry, perform the procedure [Changing the Attributes of a Service Selector Entry for the MO SMS B-Party Routing Feature](#) using the service selector information that would have been used in this procedure. Do not perform the remainder of this procedure.
- If the number of service selector entries is 20992 and you wish to remove an existing service selector entry, perform the procedure [Removing a Service](#)

Selector Entry. After the service selector entry has been removed, continue the procedure with [3](#).

- If the number of service selector entries is less than 20992, continue the procedure with [3](#).
3. ITU service selectors cannot be added to the database if the ANSIGFLEX STP option is enabled.

If ITU service selectors are not shown in the `rtrv-srvsel` output in [2](#), and ITU service selectors will be added, verify whether or not the ANSIGFLEX STP option is enabled by entering the `rtrv-stpopts` command.

The following is an example of the possible output.

```
rlghncxa03w 08-09-28 21:15:37 GMT EAGLE5 39.1.0
STP OPTIONS
-----
ANSIGFLEX          no
```

 **Note:**

The `rtrv-stpopts` command output contains other fields that are not used by this procedure. If you wish to see all the fields displayed by the `rtrv-stpopts` command, refer to the `rtrv-stpopts` command description in the *Commands Manual*.

The value `yes` in the `rtrv-stpopts` output for the ANSIGFLEX field shows that the ANSIGFLEX STP option is enabled.

If any of these conditions are present.

- The value for the ANSIGFLEX field is `no`.
- ITU service selectors are shown in the `rtrv-srvsel` output in [2](#), shown by the `GTII`, `GTIN`, or `GTIN24` columns.
- No ITU service selectors will be added.

Continue the procedure by performing one of these steps.

- Continue the procedure with [8](#) if:
 - The `off=gttrqd` parameter will be specified for the service selector entry, or
 - The `on=gttrqd` parameter will be specified value for the service selector entry and the `rtrv-srvsel` output contains entries whose `GTTRQD` value is `on`, and
 - The `dfltact` value will be either `fallback` or `falltogtt`.
- Continue the procedure with [7](#) if:
 - The `off=gttrqd` parameter will be specified for the service selector entry, or
 - The `on=gttrqd` parameter will be specified value for the service selector entry and the `rtrv-srvsel` output contains entries whose `GTTRQD` value is `on`, and

- The `dfltact` value will be a GTT action identifier.
- Continue the procedure with 5 if the `on=gttrqd` parameter will be specified value for the service selector entry and the `rtrv-srvsel` output contains no entries whose `GTTRQD` value is `on`.

If the value for the `ANSIGFLEX` field is `yes`, continue the procedure with 4.

4. Change the `ANSIGFLEX` STP option value to `no` by entering this command.

```
chg-stpopts:off=ansigflex
```

When this command has successfully completed, the following message should appear.

```
rlghncxa03w 08-09-28 21:15:37 GMT EAGLE5 39.1.0
CHG-STPOPTS: MASP A - COMPLTD
```

Caution:

After changing the `ANSIGFLEX` value to `no` in this step, and adding the ITU service selectors in 8, the `ANSIGFLEX` STP option cannot be enabled.

5. Enter this command to verify if any DSMs are in the database.

```
rtrv-stp:gpl=vscpp
```

This is an example of the possible output.

```
rlghncxa03w 10-07-28 21:15:37 GMT EAGLE5 42.0.0
Card Part Number Rev Serial Number Type DB APPL GPL
Version
-----
-----
1101 870-1275-01 W 10245689323 DSM 4096M VSCCP
133-029-000
1201 870-1275-01 W 10245689337 DSM 4096M VSCCP
133-029-000
1301 870-1275-01 W 10245689353 DSM 4096M VSCCP
133-029-000
```

If no entries are shown in the `rtrv-stp` output, continue the procedure with 6.

If entries are shown in the `rtrv-stp` output, the EAGLE contains DSM cards. The `on=gttrqd` parameter cannot be specified if the EAGLE contains Legacy DSMs. To specify the `on=gttrqd` parameter, all the DSMs must be replaced by E5-SM4G or E5-SM8G-B cards. Contact My Oracle Support before replacing any service modules. Refer to [#unique_17](#) for the contact information.

After the DSMs have been replaced, continue the procedure by performing one of these steps.

- Continue the procedure with if the `dfltact` value will be either `fallback` or `falltogtt`

- Continue the procedure with [6](#) if the `dfltact` value will be a GTT action identifier.
6. Enter this command to verify if any E5-SM4G cards are in the database.

```
rtrv-stp:gpl=sccphc
```

This is an example of the possible output.

```
rlghncxa03w 10-07-28 21:15:37 GMT EAGLE5 42.0.0
Card Part Number Rev Serial Number Type DB APPL GPL
Version
-----
1106 870-2860-01 W 10245689404 DSM 4096M SCCPHC
133-029-000
1206 870-2860-01 W 10245689453 DSM 4096M SCCPHC
133-029-000
1306 870-2860-01 W 10245689499 DSM 4096M SCCPHC
133-029-000
```

If entries no are shown in the `rtrv-stp` output, the EAGLE does not contains any E5-SM4G cards. To specify the `on=gttrqd` parameter, the EAGLE must contain E5-SM4G or E5-SM8G-B cards. Perform the [Adding a Service Module](#) procedure to add E5-SM4G or E5-SM8G-B cards to the database.

If entries are shown in the `rtrv-stp` output or the [Adding a Service Module](#) procedure has been performed, continue the procedure by performing one of these steps.

- Continue the procedure with [8](#) if the `dfltact` value will be either `fallback` or `falltogtt`
 - Continue the procedure with [7](#) if the `dfltact` value will be a GTT action identifier.
7. Display the GTT action identifiers by entering the `rtrv-gttact` command.

This is an example of the possible output.

```
rlghncxa03w 10-07-28 21:15:37 GMT EAGLE5 42.0.0

ACTID      ACTION  ATCAPERR ITCAPERR UDTSERR UIMREQD
-----
action2    disc   ---      ---      ---      off

ACTID      ACTION  PCA          RI  SSN  MRNSET  MAPSET
-----
action1    dup     002-002-002  gt  ---  DFLT    -----
          CDGTMODID = -----  CGGTMODID = -----
          USEICMSG = off      CGPCOGMSG = dflt      CGPCA = ---
action3    dup     003-003-003  gt  ---  1        -----
          CDGTMODID = -----  CGGTMODID = -----
          USEICMSG = off      CGPCOGMSG = dflt      CGPCA = ---

ACTID      ACTION  PCI          RI  SSN  MRNSET  MAPSET
-----
```

```

---
ACTID      ACTION    PCN          RI  SSN  MRNSET  MAPSET
-----
---
ACTID      ACTION    PCN24       RI  SSN  MRNSET  MAPSET
-----
---

```

GTT-ACT table is (3 of 2000) 1% full.

The `dfltact` parameter value must be a GTT action identifier (the `ACTID` value in the `rtrv-gttact` output) whose `ACTION` value is either `disc`, `udts`, or `tcaperr`.

If the desired GTT action identifier is not shown in the `rtrv-gttact` output, add the desired GTT action identifier by performing the [Adding a GTT Action](#) procedure.

If the desired GTT action identifier is shown in the `rtrv-gttact` output or the [Adding a GTT Action](#) procedure was performed, continue the procedure with 8.

8. Add the new service selector for the MO SMS B-Party Routing feature by entering the `ent-srvsel` command with the appropriate parameter combinations shown in [Table A-3](#).

Table A-3 Parameter Combinations for Adding Service Selectors for the MO SMS B-Party Routing Feature

ANSI Service Selector	ITU Service Selector
Mandatory Parameters	
<code>:gti/gtia = 2</code>	<code>:gtii/gtin/gtin24 = 2, 4</code>
<code>:serv = smsmr</code>	<code>:serv = smsmr</code>
<code>:tt = 0-255</code>	<code>:tt = 0-255</code>
<code>:ssn = 0-255, *</code>	<code>:ssn = 0-255, *</code>
<code>:snp = e164</code>	<code>:snp=e164</code>
<code>:snai = sub, natl, intl, rnidn, rnndn, rnsdn, ccrndn</code>	<code>:snai = sub, natl, intl, rnidn, rnndn, rnsdn, ccrndn</code>
	<code>:nai or :naiv - See the Note</code>
	<code>:np or :npv - See the Note</code>
Optional Parameters	
<code>:dfltact = the disc/udts/tcaperr GTT action identifier shown in the <code>rtrv-gttact</code> output, fallback, or falltogtt. Default value = fallback</code>	<code>:dfltact = the disc/udts/tcaperr GTT action identifier shown in the <code>rtrv-gttact</code> output, fallback, or falltogtt. Default value = fallback</code>
<code>:on=gtrrqd - This parameter cannot be specified if the <code>off=gtrrqd</code> parameter is specified. Default value=off</code>	<code>:on=gtrrqd - This parameter cannot be specified if the <code>off=gtrrqd</code> parameter is specified. Default value=off</code>

Table A-3 (Cont.) Parameter Combinations for Adding Service Selectors for the MO SMS B-Party Routing Feature

ANSI Service Selector	ITU Service Selector
:off=gttrqd - This parameter cannot be specified if the on=gttrqd parameter is specified. Default value=off	:off=gttrqd - This parameter cannot be specified if the on=gttrqd parameter is specified. Default value=off
:gttselid = 0 - 65534. Default value = no value is specified.	:gttselid = 0 - 65534. Default value = no value is specified.
<p>Note: The nai and naiiv, and the np and npv parameters cannot be specified together in the ent-srvsel command. Refer to Table A-1 for the nai and naiiv parameter values. Refer to Adding a Service Selector Entry for the MO SMS B-Party Routing Feature for the np and npv parameter values. The nai, naiiv, np, and npv parameters can be specified only if the gtii/gtin/gtin24 parameter value is 4.</p>	

For this example, enter these commands.

```
ent-
srvsel:gtia=2:serv:smsmr:tt=25:ssn=50:snp=e164:snai=natl:dflt
act=action2:gttselid=3

ent-srvsel:gtii=2:serv:smsmr:tt=35:ssn=60:snp=e164:snai=intl

ent-
srvsel:gtin=4:serv:smsmr:tt=45:ssn=70:snp=e164:snai=sub:nai=i
ntl:npv=5:on=gttrqd
```

When each of these commands have successfully completed, the following message should appear.

```
rlghncxa03w 08-09-28 21:15:37 GMT EAGLE5 39.1.0
ENT-SRVSEL: MASP A - COMPLTD
```

- Verify the changes using the rtrv-srvsel command and specifying these parameters and values that were specified in 8.
 - gti/gtia/gtii/gtin/gtin24
 - tt
 - ssn
 - serv=smsmr
 - snp=e164
 - snai
 - The np/npv parameter must be specified with the rtrv-srvsel command if the gtii/gtin/gtin24=4 parameter was specified in 8.
 - The nai/naiiv parameter must be specified with the rtrv-srvsel command if the gtii/gtin/gtin24=4 parameter was specified in 8.

For this example, enter these commands.

```
rtrv-srvsel:gtia=2:serv:smsmr:tt=25:ssn=50:snp=e164:snai=natl
```

This is an example of the possible output.

```
rlghncxa03w 10-07-28 21:15:37 GMT EAGLE5 42.0.0
```

```
GTIA   TT   NP       NAI   SSN  SNP   SNAI   SERV  GTTRQD
2      25  --      ----  50   e164  natl   smsmr off
DFLTACT=action2  GTTSELID=3
```

```
SRV SELECTOR table is (13 of 20992) 1 % full
```

```
rtrv-srvsel:gtii=2:serv:smsmr:tt=35:ssn=60:snp=e164:snai=intl
```

This is an example of the possible output.

```
rlghncxa03w 10-07-28 21:15:37 GMT EAGLE5 42.0.0
```

```
GTII   TT   NP       NAI   SSN  SNP   SNAI   SERV  GTTRQD
2      35  --      ----  60   e164  intl   smsmr off
DFLTACT=fallback  GTTSELID=none
```

```
SRV SELECTOR table is (13 of 20992) 1 % full
```

```
rtrv-
```

```
srvsel:gtin=4:serv:smsmr:tt=45:ssn=70:snp=e164:snai=sub :nai=
intl:npv=5
```

This is an example of the possible output.

```
rlghncxa03w 10-07-28 21:15:37 GMT EAGLE5 42.0.0
```

```
GTIN   TT   NP       NAI   SSN  SNP   SNAI   SERV  GTTRQD
4      45  e210    intl  75   e164  sub    smsmr on
DFLTACT=fallback  GTTSELID=none
```

```
SRV SELECTOR table is (13 of 20992) 1 % full
```

10. Back up the new changes using the `chg-db:action=backup:dest=fixed` command. These messages should appear, the active Maintenance and Administration Subsystem Processor (MASP) appears first.

```
BACKUP (FIXED) : MASP A - Backup starts on active MASP.
BACKUP (FIXED) : MASP A - Backup on active MASP to fixed disk
complete.
BACKUP (FIXED) : MASP A - Backup starts on standby MASP.
BACKUP (FIXED) : MASP A - Backup on standby MASP to fixed disk
complete.
```

Figure A-6 Add a Service Selector Entry for the MO SMS B-Party Routing Feature - Sheet 1 of 3

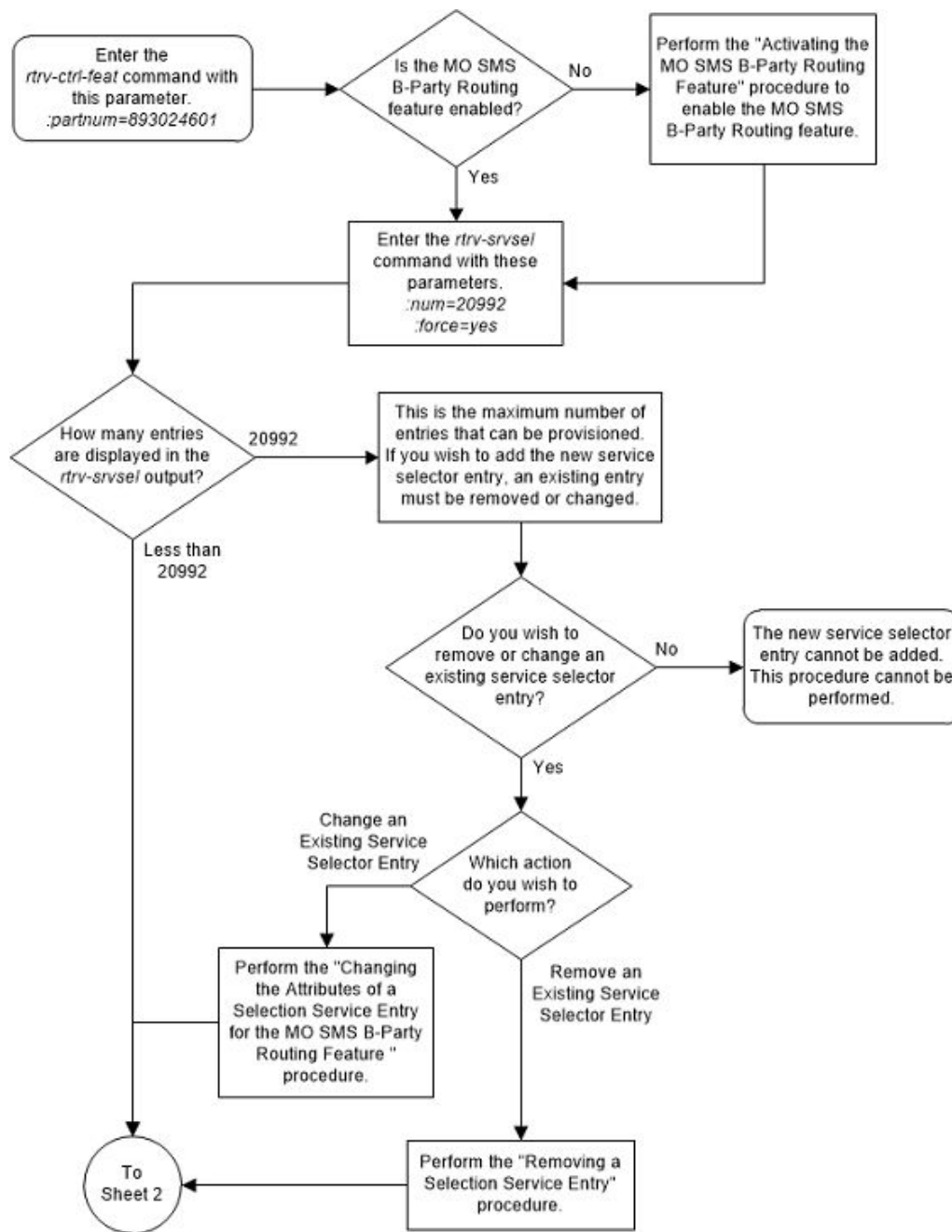

Figure A-7 Add a Service Selector Entry for the MO SMS B-Party Routing Feature - Sheet 2 of 3

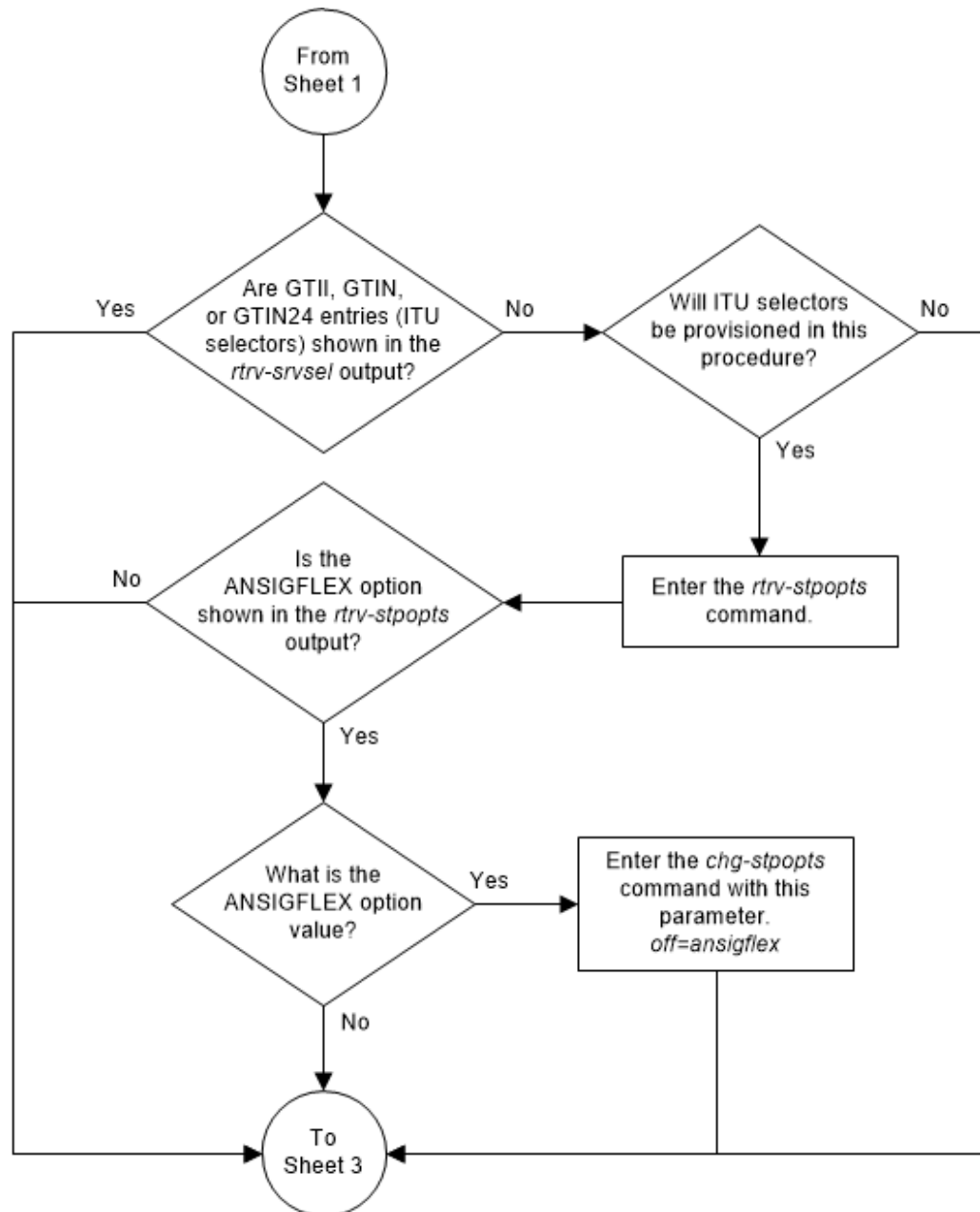
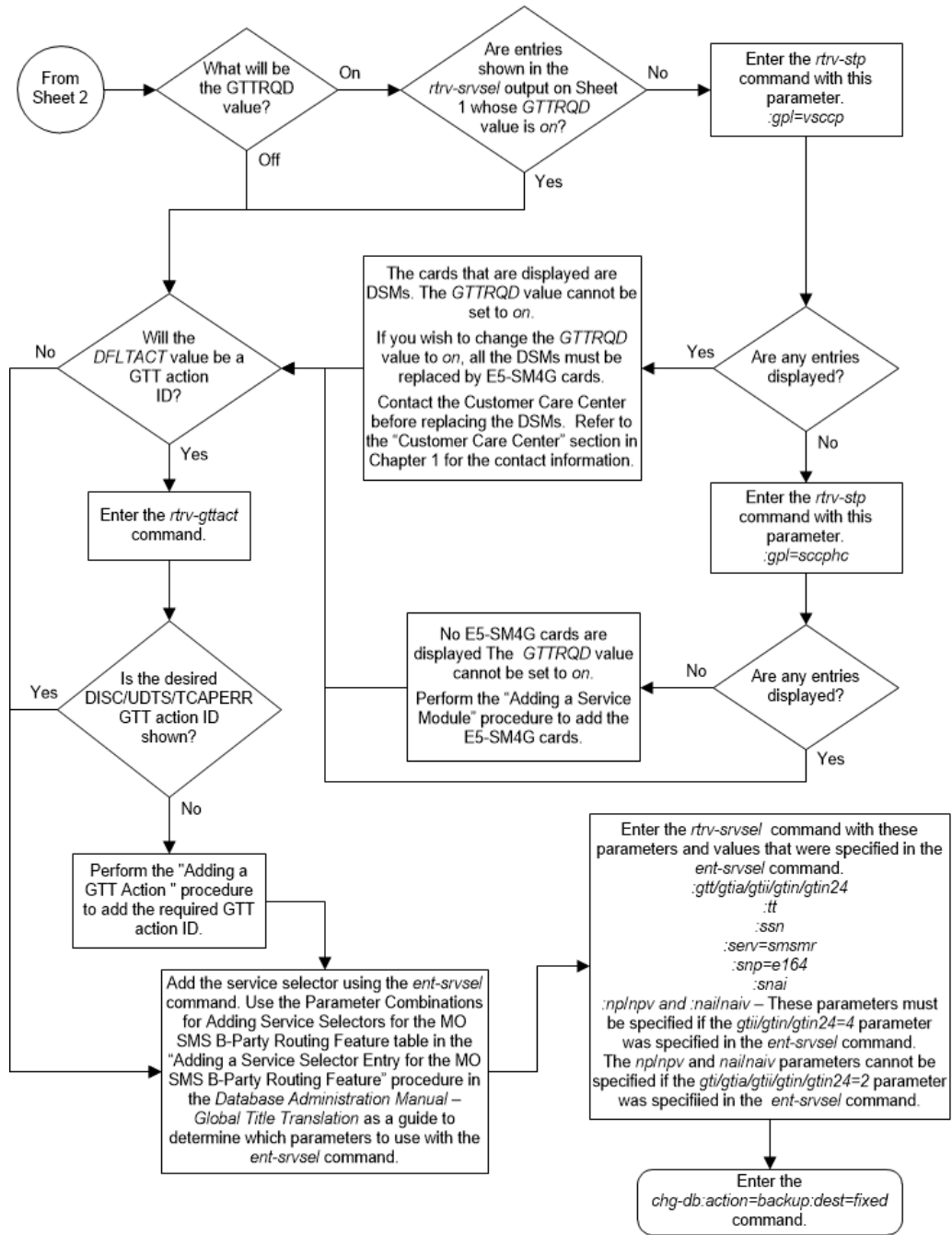

Figure A-8 Add a Service Selector Entry for the MO SMS B-Party Routing Feature - Sheet 3 of 3



Removing a Service Selector Entry

This procedure is used to remove a service selector using the `dlt-srvsel` command.

The `dlt-srvsel` command uses these parameters.

:gti/gtia/gtii/gtin/gtin24 – The global title indicator. The GTI defines the domain as

- gti and gtia (ANSI) with GTI=2
- gtii (ITU international) with GTI=2 or GTI=4, and
- gtin and gtin24 (ITU national) with GTI=2 or GTI=4.

The gti and gtia parameters are equivalent.

:tt – The global title translation value shown in the rtrv-srvsel output for the service selector that is being removed.

:ssn – The subsystem number value shown in the rtrv-srvsel output for the service selector that is being removed.

:nai or :naiv – The nature of address indicator value shown in the rtrv-srvsel output for the service selector that is being removed. (See [Table A-4](#) for NAI/NAIV mapping)

 **Note:**

The nature of address indicator parameters (naiv or nai) can be specified by supplying either a mnemonic or an explicit value. At no time may both the mnemonic and the explicit value be specified at the same time for the same parameter. You can specify either the naiv or nai parameter. [Table A-4](#) shows the mapping between the naiv and the nai parameters.

:np or :npv – The numbering plan value shown in the rtrv-srvsel output for the service selector that is being removed. (See [Table A-5](#) for NP/NPV mapping)

 **Note:**

The numbering plan parameters (npv or np) can be specified by supplying either a mnemonic or an explicit value. At no time may both the mnemonic and the explicit value be specified at the same time for the same parameter. You can specify either the npv or np parameter. [Table A-5](#) shows the mapping between the npv and the np parameters.

Table A-4 NAI/NAI Mapping

NAIV	NAI	Description
0	--	Unknown
1	Sub	Subscriber Number
2	Rsvd	Reserved for national use
3	Natl	National significant number
4	Intl	International number
5-127	---	Spare

Table A-5 NPV/NP Mapping

NPV	NP	Description
0	--	Unknown
1	E164	ISDN/telephony numbering plan
2	Generic	Generic numbering plan
3	X121	Data numbering plan
4	F69	Telex numbering plan
5	E210	Maritime mobile numbering plan
6	E212	Land mobile numbering plan
7	E214	ISDN/mobile numbering plan
8	Private	Private network or network-specific numbering plan
9-15	---	Spare

The service selector that is being removed from the database must be shown in the `rtrv-srvsel` output.

1. Display the service selector entries by entering this command `rtrv-srvsel` command.

```
rtrv-srvsel:num=20992:force=yes
```

The following is an example of the possible output.

```
rlghncxa03w 10-07-28 21:15:37 GMT EAGLE5 42.0.0
```

```
GTIA  TT  NP    NAI  SSN  SNP  SNAI  SERV  GTTRQD
2      9  --    ---  *    e212 intl  gflex  off
DFLTACT=fallback GTTSELID=9
2      10 --    ---  3    e164 intl  gflex  off
DFLTACT=fallback GTTSELID=75
2      25  --    ----  50   e164 natl  smsmr  off
DFLTACT=action2  GTTSELID=3
2      253 --    ---  4    e214 natl  gflex  off
DFLTACT=fallback GTTSELID=80

GTII  TT  NP    NAI  SSN  SNP  SNAI  SERV  GTTRQD
2      0  --    ---  2    e164 intl  gflex  off
DFLTACT=fallback GTTSELID=56
2      18  --    ---  *    e164 rnsdn inpmr  on
DFLTACT=fallback GTTSELID=80
2      35  --    ----  60   e164 intl  smsmr  off
DFLTACT=fallback GTTSELID=none
4      0  e214 sub  *    e214 sub  gflex  off
DFLTACT=fallback GTTSELID=98

GTIN  TT  NP    NAI  SSN  SNP  SNAI  SERV  GTTRQD
2      2  --    ---  3    e164 intl  gflex  off
DFLTACT=fallback GTTSELID=8
2      9  --    --   *    ---   ---  inpq  ---
```

```

DFLTACT=----- GTTSELID=-----
4      2      e164      natl *      e164  rnndn  inpmr  on
DFLTACT=fallback GTTSELID=432
4      9      ---      ---  4      ---  ---  inpq  ---
DFLTACT=----- GTTSELID=-----
4      45     e210      intl 75     e164  sub    smsmr on
DFLTACT=fallback GTTSELID=none

SRV_SELECTOR table is (13 of 20992)  1 % full

```

 **Note:**

If the `rtrv-srvsel` command is entered with no other parameters specified, a maximum of 50 entries are displayed. To display more than 50 entries, the `force=yes` parameter must be specified with the `rtrv-srvsel` command and the `num` parameter value must be greater than 50. Since there can be a maximum of 20992 service selectors in the database, to display all the service selectors in the database, the `force=yes` and `num=20992` parameters must be specified with the `rtrv-srvsel` command.

2. From the `rtrv-srvsel` output in 1, select the service selector that will be removed. Record all the values for this service selector. These values will be used in 4 with the `rtrv-srvsel` command to verify that the service selector has been removed from the database.
3. Remove the service selector from the database by entering the `dlt-srvsel` command with the appropriate parameter combinations shown in Table A-6.

Table A-6 Parameter Combinations for Removing Service Selectors

ANSI Service Selector	ITU Service Selector
:gti/gtia = 2	:gtii/gtin/gtin24 = 2, 4
:tt = the value shown in the <code>rtrv-srvsel</code> output.	:tt = the value shown in the <code>rtrv-srvsel</code> output.
:ssn = the value shown in the <code>rtrv-srvsel</code> output.	:ssn = the value shown in the <code>rtrv-srvsel</code> output.
	:nai or :naiv - the value shown in the <code>rtrv-srvsel</code> output. See the Note
	:np or :npv - the value shown in the <code>rtrv-srvsel</code> output. See the Note

Note: The `nai` and `naiv`, and the `np` and `npv` parameters cannot be specified together in the `dlt-srvsel` command. Refer to Table A-4 for the `nai` and `naiv` parameter values. Refer to Table A-5 for the `np` and `npv` parameter values. The `nai`, `naiv`, `np`, and `npv` parameters can be specified only if the `gtii/gtin/gtin24` parameter value is 4.

For this example, enter these commands.

```

dlt-srvsel:gtia=2:tt=25:ssn=50
dlt-srvsel:gtii=2::tt=35:ssn=60
dlt-srvsel:gtin=4:tt=45:ssn=70:nai=intl:npv=5

```

When each of these commands have successfully completed, the following message should appear.

```
rlghncxa03w 08-09-28 21:15:37 GMT EAGLE5 39.1.0
DLT-SRVSEL: MASP A - COMPLTD
```

4. Verify the changes using the `rtrv-srvsel` command and specifying the values that were recorded in 2.

For this example, enter these commands.

```
rtrv-srvsel:gtia=2:serv:smsmr:tt=25:ssn=50:snp=e164:snai=natl
rtrv-srvsel:gtii=2:serv:smsmr:tt=35:ssn=60:snp=e164:snai=intl
rtrv-
srvsel:gtin=4:serv:smsmr:tt=45:ssn=70:snp=e164:snai=sub :nai=
intl:npv=5
```

When each of these commands have successfully completed, this output is displayed showing that the service selector is not in the database.

```
rlghncxa03w 08-09-28 21:15:37 GMT EAGLE5 39.1.0

GTIN    TT    NP      NAI    SSN    SNP    SNAI    SERV
No SRV Selector found in range
```

5. Back up the new changes using the `chg-db:action=backup:dest=fixed` command. These messages should appear, the active Maintenance and Administration Subsystem Processor (MASP) appears first.

```
BACKUP (FIXED) : MASP A - Backup starts on active MASP.
BACKUP (FIXED) : MASP A - Backup on active MASP to fixed disk
complete.
BACKUP (FIXED) : MASP A - Backup starts on standby MASP.
BACKUP (FIXED) : MASP A - Backup on standby MASP to fixed disk
complete.
```

Figure A-9 Remove a Service Selector Entry

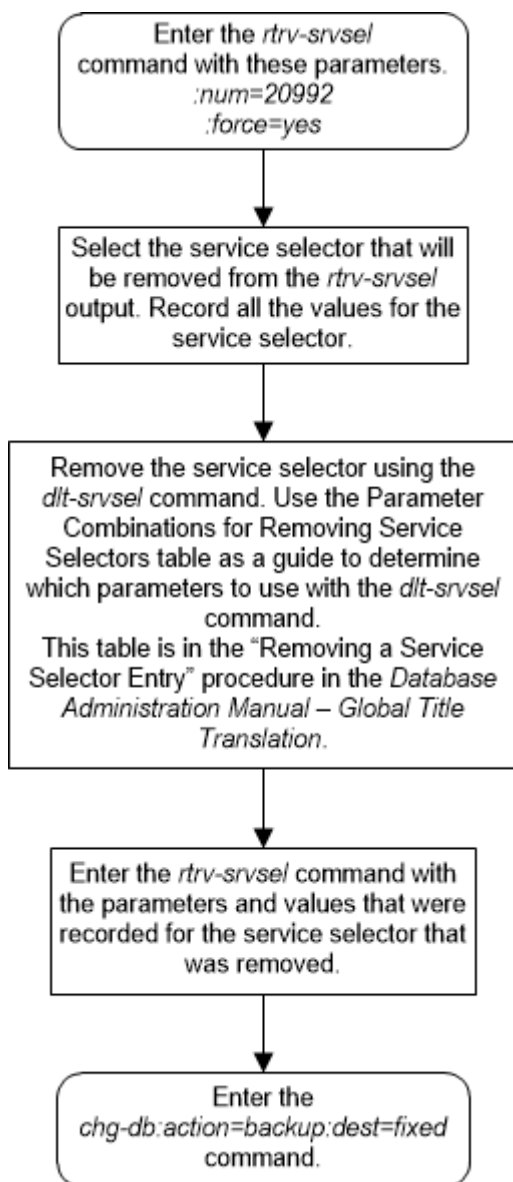

Changing the Attributes of a Service Selector Entry for the MO SMS B-Party Routing Feature

This procedure is used to provision an entry in the service selector table for the MO SMS B-Party Routing feature using the `chg-srvsel` command.

The `chg-srvsel` command uses these parameters.

:gti/gtia/gtii/gtin/gtin24 – The global title indicator. The GTI defines the domain as

- `gti` and `gtia` (ANSI) with GTI=2

- `gtii` (ITU international) with `GTI=2` or `GTI=4`, and
- `gtin` and `gtin24` (ITU national) with `GTI=2` or `GTI=4`.

The `gti` and `gtia` parameters are equivalent.

`:nserv` – the DSM service - `smsmr`.

`:tt` – The global title translation type value shown in the `rtrv-srvsel` output for the service selector that is being changed.

`:ssn` – The subsystem number shown in the `rtrv-srvsel` output for the service selector that is being changed.

`:ndfltact` - The default action identifier that is associated with the service selector entry. This parameter has one of these values.

- A GTT action identifier shown in the `rtrv-gttact` output whose `ACTION` value is either `disc`, `udts`, or `tcaperr`.
- `fallback` - Fallback to the relay data. The relayed MSU is routed according to the routing data provided by the service.
- `falltoggtt` - Fallback to GTT. If the `gttselid` parameter has a value other than `none`, and the GTT selector search fails, the GTT selector search is performed again using the `gttselid=none` parameter.

`:on=gttrqd` - Global title translation is required after the service execution is complete and the message is relayed by the service.

`:off=gttrqd` - Global title translation is not required after the service execution is complete and the message is relayed by the service.

`:ngttselid` - The GTT selector ID user for performing global title translation on messages that are relayed by the service. (0 - 65534, or `none`)

`:nai` or `:naiv` – The nature of address indicator shown in the `rtrv-srvsel` output for the service selector that is being changed. See [Table A-7](#) for NAI/NAIV mapping.

Note:

The nature of address indicator parameters (`naiv` or `nai`) can be specified by supplying either a mnemonic or an explicit value. At no time may both the mnemonic and the explicit value be specified at the same time for the same parameter. You can specify either the `naiv` or `nai` parameter. [Table A-7](#) shows the mapping between the `naiv` and the `nai` parameters.

`:np` or `:npv` – The numbering plan value shown in the `rtrv-srvsel` output for the service selector that is being changed. See [Table A-8](#) for NP/NPV mapping.

 **Note:**

The numbering plan parameters (`npv` or `np`) can be specified by supplying either a mnemonic or an explicit value. At no time may both the mnemonic and the explicit value be specified at the same time for the same parameter. You can specify either the `npv` or `np` parameter. [Table A-8](#) shows the mapping between the `npv` and the `np` parameters.

`:nsnai` – The service nature of address indicator.

- `natl` — National significant number
- `intl` — International number
- `rnidn` — Routing number prefix and international dialed/directory number
- `rnndn` — Routing number prefix and national dialed/directory number
- `rnsdn` — Routing number prefix and subscriber dialed/directory number
- `ccrndn` — Country code, routing number, and national directory number
- `sub` — Subscriber number

`:nsnp` – The service numbering plan - e164

Table A-7 NAIV/NAI Mapping

NAIV	NAI	Description
0	---	Unknown
1	Sub	Subscriber Number
2	Rsvd	Reserved for national use
3	Natl	National significant number
4	Intl	International number
5-127	---	Spare

Table A-8 NPV/NP Mapping

NPV	NP	Description
0	---	Unknown
1	E164	ISDN/telephony numbering plan
2	Generic	Generic numbering plan
3	X121	Data numbering plan
4	F69	Telex numbering plan
5	E210	Maritime mobile numbering plan
6	E212	Land mobile numbering plan
7	E214	ISDN/mobile numbering plan
8	Private	Private network or network-specific numbering plan
9-15	---	Spare

To perform this procedure, the MO SMS B-Party Routing feature must be enabled. Enter the `rtrv-ctrl-feat` command with the MO SMS B-Party Routing part number, 893024601, to verify whether or not the MO SMS B-Party Routing feature is enabled. If the MO SMS B-Party Routing feature is not enabled, perform the procedure [Activating the MO SMS B-Party Routing Feature](#) to enable MO SMS B-Party Routing feature.

1. Display the service selector entries by entering this command `rtrv-srvsel` command.

```
rtrv-srvsel:num=20992:force=yes
```

The following is an example of the possible output.

```
rlghncxa03w 10-07-28 21:15:37 GMT EAGLE5 42.0.0
```

```
GTIA  TT  NP      NAI  SSN  SNP  SNAI  SERV  GTTRQD
2      9  --      ---  *    e212 intl  gflex  off
DFLTACT=fallback GTTSELID=9
2      10 --      ---  3    e164 intl  gflex  off
DFLTACT=fallback GTTSELID=75
2      25  --      ----  50   e164 natl  smsmr  off
DFLTACT=action2  GTTSELID=3
2      253 --      ---  4    e214 natl  gflex  off
DFLTACT=fallback GTTSELID=80
```

```
GTII  TT  NP      NAI  SSN  SNP  SNAI  SERV  GTTRQD
2      0  --      ---  2    e164 intl  gflex  off
DFLTACT=fallback GTTSELID=56
2      18  --      ---  *    e164 rnsdn inpmr  on
DFLTACT=fallback GTTSELID=80
2      35  --      ----  60   e164 intl  smsmr  off
DFLTACT=fallback GTTSELID=none
4      0  e214  sub  *    e214 sub  gflex  off
DFLTACT=fallback GTTSELID=98
```

```
GTIN  TT  NP      NAI  SSN  SNP  SNAI  SERV  GTTRQD
2      2  --      ---  3    e164 intl  gflex  off
DFLTACT=fallback GTTSELID=8
2      9  --      --   *    ---   ---  inpq   ---
DFLTACT=----- GTTSELID=-----
4      2  e164  natl *    e164 rnndn inpmr  on
DFLTACT=fallback GTTSELID=432
4      9  ---   ---  4    ---   ---  inpq   ---
DFLTACT=----- GTTSELID=-----
4      45 e210  intl 75   e164 sub  smsmr  on
DFLTACT=fallback GTTSELID=none
```

```
SRV SELECTOR table is (13 of 20992) 1 % full
```

 **Note:**

If the `rtrv-srvsel` command is entered with no other parameters specified, a maximum of 50 entries are displayed. To display more than 50 entries, the `force=yes` parameter must be specified with the `rtrv-srvsel` command and the `num` parameter value must be greater than 50. Since there can be a maximum of 20992 service selectors in the database, to display all the service selectors in the database, the `force=yes` and `num=20992` parameters must be specified with the `rtrv-srvsel` command.

If the value `smsmr` is shown in the `SERV` column of the `rtrv-srvsel` output, continue the procedure with [3](#).

If the value `smsmr` is not shown in the `SERV` column of the `rtrv-srvsel` output, continue the procedure with [2](#).

2. Verify the status of the MO SMS B-Party Routing feature by entering the `rtrv-ctrl-feat` command with the MO SMS B-Party Routing feature part number. Enter this command.

```
rtrv-ctrl-feat:partnum=893024601
```

The following is an example of the possible output.

```
rlghncxa03w 08-09-28 21:15:37 GMT EAGLE5 39.1.0
The following features have been permanently enabled:
```

Feature Name	Partnum	Status	Quantity
MO SMS B-Party Routing	893024610	on	----

The following features have been temporarily enabled:

Feature Name	Partnum	Status	Quantity	Trial
Period Left				
Zero entries found.				

The following features have expired temporary keys:

Feature Name	Partnum
Zero entries found.	

If the MO SMS B-Party Routing feature has not been enabled, perform the procedure [Activating the MO SMS B-Party Routing Feature](#) procedure to enable this feature.

3. From the `rtrv-srvsel` output in [1](#), select the service selector that will be removed. Record all the values for this service selector. These values and the new values for the `snp`, `sna`, and `serv` parameters will be used in [8](#) with the `rtrv-srvsel` command to verify the changes that will be made to the service selector.

Continue the procedure by performing one of these steps.

- Continue the procedure with [7](#) if:

- The `off=gttrqd` parameter will be specified for the service selector entry, or
 - The `on=gttrqd` parameter will be specified value for the service selector entry and the `rtrv-srvsel` output contains entries whose `GTTRQD` value is `on`, and
 - The `ndfltact` value will be either `fallback` or `falltogtt`.
 - Continue the procedure with 6 if:
 - The `off=gttrqd` parameter will be specified for the service selector entry, or
 - The `on=gttrqd` parameter will be specified value for the service selector entry and the `rtrv-srvsel` output contains entries whose `GTTRQD` value is `on`, and
 - The `ndfltact` value will be a GTT action identifier.
 - Continue the procedure with 4 if the `on=gttrqd` parameter will be specified value for the service selector entry and the `rtrv-srvsel` output contains no entries whose `GTTRQD` value is `on`.
4. Enter this command to verify if any DSMs or SLICs are in the database.

```
rtrv-stp:gpl=vsccp
```

This is an example of the possible output.

```
rlghncxa03w 10-07-28 21:15:37 GMT EAGLE5 42.0.0
Card Part Number Rev Serial Number Type DB APPL GPL
Version
-----
-----
1101 870-1275-01 W 10245689323 DSM 4096M VSCCP
133-029-000
1201 870-1275-01 W 10245689337 DSM 4096M VSCCP
133-029-000
1301 870-1275-01 W 10245689353 DSM 4096M VSCCP
133-029-000
```

If no entries are shown in the `rtrv-stp` output, continue the procedure with 5.

If entries are shown in the `rtrv-stp` output, the EAGLE contains Legacy DSM cards. The `on=gttrqd` parameter cannot be specified if the EAGLE contains Legacy DSMs. To specify the `on=gttrqd` parameter, all the DSMs must be replaced by E5-SM4G or E5-SM8G-B cards. Contact My Oracle Support before replacing any service modules. Refer to [#unique_17](#) for the contact information.

After the DSMs have been replaced, continue the procedure by performing one of these steps.

- Continue the procedure with if the `ndfltact` value will be either `fallback` or `falltogtt`
 - Continue the procedure with if the `ndfltact` value will be a GTT action identifier.
5. Enter this command to verify if any E5-SM4G cards are in the database.

```
rtrv-stp:gpl=scpcpc
```

This is an example of the possible output.

```
rlghncxa03w 10-07-28 21:15:37 GMT EAGLE5 42.0.0
Card Part Number Rev Serial Number Type DB APPL GPL
Version
-----
-----
1106 870-2860-01 W 10245689404 DSM 4096M SCCPHC
133-029-000
1206 870-2860-01 W 10245689453 DSM 4096M SCCPHC
133-029-000
1306 870-2860-01 W 10245689499 DSM 4096M SCCPHC
133-029-000
```

If entries no are shown in the `rtrv-stp` output, the EAGLE does not contains any DSM cards. To specify the `on=gttrqd` parameter, the EAGLE must contain DSM cards. Perform the [Adding a Service Module](#) procedure to add E5-SM4G or E5-SM8G-B cards to the database.

If entries are shown in the `rtrv-stp` output or the [Adding a Service Module](#) procedure has been performed, continue the procedure by performing one of these steps.

- Continue the procedure with [7](#) if the `ndfltact` value will be either `fallback` or `falltogtt`
- Continue the procedure with [6](#) if the `ndfltact` value will be a GTT action identifier.

6. Display the GTT action identifiers by entering the `rtrv-gttact` command.

This is an example of the possible output.

```
rlghncxa03w 10-07-28 21:15:37 GMT EAGLE5 42.0.0

ACTID ACTION ATCAPERR ITCAPERR UDTSEERR UIMREQD
-----
action2 disc --- --- --- off

ACTID ACTION PCA RI SSN MRNSET MAPSET
-----
---
action1 dup 002-002-002 gt --- DFLT -----
CDGTMODID = ----- CGGTMODID = -----
USEICMSG = off CGPCOGMSG = dflt CGPCA = ---
action3 dup 003-003-003 gt --- 1 -----
CDGTMODID = ----- CGGTMODID = -----
USEICMSG = off CGPCOGMSG = dflt CGPCA = ---

ACTID ACTION PCI RI SSN MRNSET MAPSET
-----
---

ACTID ACTION PCN RI SSN MRNSET MAPSET
-----
```



```

---
ACTID      ACTION  PCN24      RI  SSN  MRNSET  MAPSET
-----
---

```

GTT-ACT table is (3 of 2000) 1% full.

The `ndfltact` parameter value must be a GTT action identifier (the `ACTID` value in the `rtrv-gttact` output) whose `ACTION` value is either `disc`, `udts`, or `tcaperr`.

If the desired GTT action identifier is not shown in the `rtrv-gttact` output, add the desired GTT action identifier by performing the [Adding a GTT Action](#) procedure.

If the desired GTT action identifier is shown in the `rtrv-gttact` output or the [Adding a GTT Action](#) procedure was performed, continue the procedure with 7.

7. Change the service selector by entering the `chg-srvsel` command with the appropriate parameter combinations shown in [Table A-9](#).

Table A-9 Parameter Combinations for Changing Service Selectors for the MO SMS B-Party Routing Feature

ANSI Service Selector	ITU Service Selector	
Mandatory Parameters		
<code>:gti/gtia = 2</code>	<code>:gtii/gtin/gtin24 = 2</code>	<code>:gtii/gtin/gtin24 = 4</code>
<code>:tt = the value shown in the rtrv-srvsel output.</code>	<code>:tt = the value shown in the rtrv-srvsel output.</code>	<code>:tt = the value shown in the rtrv-srvsel output.</code>
<code>:ssn = the value shown in the rtrv-srvsel output.</code>	<code>:ssn = the value shown in the rtrv-srvsel output.</code>	<code>:ssn = the value shown in the rtrv-srvsel output.</code>
		<code>:nai or :naiv - the value shown in the rtrv-srvsel output. See Note 1.</code>
		<code>:np or :npv - the value shown in the rtrv-srvsel output. See Note 1.</code>
Optional Parameters (See Note 2)		
<code>:nserv = smsmr (See Note 3)</code>	<code>:nserv = smsmr (See Note 3)</code>	<code>:nserv = smsmr (See Note 3)</code>
<code>:nsnp = e164 (See Note 3)</code>	<code>:nsnp= e164 (See Note 3)</code>	<code>:nsnp = e164 (See Note 3)</code>
<code>:nsnai = sub, natl, intl, rnidn, rnsdn, ccrndn</code>	<code>:nsnai = sub, natl, intl, rnidn, rnsdn, ccrndn</code>	<code>:nsnai = sub, natl, intl, rnidn, rnsdn, ccrndn</code>
<code>:ndfltact = the disc/udts/tcaperr GTT action identifier shown in the rtrv-gttact output, fallback, or falltogtt.</code>	<code>:ndfltact = the disc/udts/tcaperr GTT action identifier shown in the rtrv-gttact output, fallback, or falltogtt.</code>	<code>:ndfltact = the disc/udts/tcaperr GTT action identifier shown in the rtrv-gttact output, fallback, or falltogtt.</code>
<code>:on=gttrqd - This parameter cannot be specified if the off=gttrqd parameter is specified.</code>	<code>:on=gttrqd - This parameter cannot be specified if the off=gttrqd parameter is specified.</code>	<code>:on=gttrqd - This parameter cannot be specified if the off=gttrqd parameter is specified.</code>

Table A-9 (Cont.) Parameter Combinations for Changing Service Selectors for the MO SMS B-Party Routing Feature

ANSI Service Selector	ITU Service Selector	
:off=gttrqd - This parameter cannot be specified if the on=gttrqd parameter is specified.	:off=gttrqd - This parameter cannot be specified if the on=gttrqd parameter is specified.	:off=gttrqd - This parameter cannot be specified if the on=gttrqd parameter is specified.
:ngttselid = 0 - 65534, or none.	:ngttselid = 0 - 65534, or none.	:ngttselid = 0 - 65534, or none.
Notes:		
1. The nai and naiv, and the np and npv parameters cannot be specified together in the chg-srvsel command. Refer to Table A-7 for the nai and naiv parameter values. Refer to Table A-8 for the np and npv parameter values. The nai, naiv, np, and npv parameters can be specified only if the gtii/gtin/gtin24 parameter value is 4.		
2. A minimum of one optional parameter must be specified for the chg-srvsel command. The value of any optional parameter that is not specified is not changed.		
3. If the current SERV value is smsmr, the nserv and nsnp parameters cannot be specified. The SERV and SNP values cannot be changed.		

For this example, enter these commands.

```
chg-srvsel:gtia=2:tt=25:ssn=50:nsnai=rnndn:on=gttrqd
```

```
chg-
```

```
srvsel:gtia=2:tt=253:ssn=4:nserv=smsmr:nsnp=e164:nsnai=rnidn  
:on=gttrqd:ndfltact=action2
```

```
chg-srvsel:gtii=2:tt=35:ssn=60:nsnai=sub
```

```
chg-
```

```
srvsel:gtii=4:tt=0:ssn=*:nai=sub:np=e214:nserv=smsmr :nsnp=e1  
64:nsnai=rnsdn :on=gttrqd:ngttselid=70
```

```
chg-
```

```
srvsel:gtin=4:tt=45:ssn=75:nai=intl:np=e210:nsnai=natl:ndflta  
ct=action2:ngttselid=55
```

```
chg-srvsel:gtin=2:tt=9:ssn=*:nserv=smsmr:nsnp=e164:nsnai=natl
```

When each of these commands have successfully completed, the following message should appear.

```
rlghncxa03w 08-09-28 21:15:37 GMT EAGLE5 39.1.0  
CHG-SRVSEL: MASP A - COMPLTD
```

- Verify the changes using the rtrv-srvsel command and specifying the values that were recorded in 3 and the new values for the snp, snai, and serv parameters, as applicable..

For this example, enter these commands.

```
rtrv-
```

```
srvsel:gtia=2:tt=25:ssn=50:snp=e164:snai=rnndn:serv:smsmr
```

This is an example of the possible output.

```
rlghncxa03w 10-07-28 21:15:37 GMT EAGLE5 42.0.0
```

```
GTIA   TT   NP       NAI   SSN  SNP   SNAI   SERV   GTTRQD
2      25   --       ----  50   e164  rnndn  smsmr  on
DFLTACT=action2  GTTSELID=3
```

```
SRV SELECTOR table is (13 of 20992) 1 % full
```

```
rtrv-
```

```
srvsel:gtia=2:tt=253:ssn=4:snp=e164:snai=rnidn:serv=smsmr
```

This is an example of the possible output.

```
rlghncxa03w 10-07-28 21:15:37 GMT EAGLE5 42.0.0
```

```
GTII   TT   NP       NAI   SSN  SNP   SNAI   SERV   GTTRQD
2      253  --       ----  4    e164  rnidn  smsmr  on
DFLTACT=action2  GTTSELID=80
```

```
SRV SELECTOR table is (13 of 20992) 1 % full
```

```
rtrv-srvsel:gtii=2:tt=35:ssn=60:snp=e164:snai=sub:serv=smsmr
```

This is an example of the possible output.

```
rlghncxa03w 10-07-28 21:15:37 GMT EAGLE5 42.0.0
```

```
GTII   TT   NP       NAI   SSN  SNP   SNAI   SERV   GTTRQD
2      35   --       ----  60   e164  sub    smsmr  off
DFLTACT=fallback  GTTSELID=none
```

```
SRV SELECTOR table is (13 of 20992) 1 % full
```

```
rtrv-
```

```
srvsel:gtin=4:tt=0:ssn=*:snp=e164:snai=sub:nai=sub :np=e214:serv:smsmr
```

This is an example of the possible output.

```
rlghncxa03w 10-07-28 21:15:37 GMT EAGLE5 42.0.0
```

```
GTII   TT   NP       NAI   SSN  SNP   SNAI   SERV   GTTRQD
4      0    e214    sub   *    e164  rnsdn  smsmr  on
DFLTACT=fallback  GTTSELID=70
```

```
SRV SELECTOR table is (13 of 20992) 1 % full
```

```
rtrv-
```

```
srvsel:gtin=4:tt=45:ssn=75:snp=e164:snai=natl:nai=intl :np=e210:serv:smsmr
```

This is an example of the possible output.

```
rlghncxa03w 10-07-28 21:15:37 GMT EAGLE5 42.0.0
```

```
GTIN   TT   NP      NAI   SSN  SNP   SNAI   SERV   GTTRQD
4      45   e210    intl  75   e164  natl   smsmr  on
DFLTACT=action2  GTTSELID=55
```

```
SRV SELECTOR table is (13 of 20992) 1 % full
```

```
rtrv-srvsel:gtin=2:tt=9:ssn=*:snp=e164:snai=natl:serv:smsmr
```

This is an example of the possible output.

```
rlghncxa03w 10-07-28 21:15:37 GMT EAGLE5 42.0.0
```

```
GTIN   TT   NP      NAI   SSN  SNP   SNAI   SERV   GTTRQD
2      9    --      ----  *    e164  natl   smsmr  off
DFLTACT=fallback  GTTSELID=none
```

```
SRV SELECTOR table is (13 of 20992) 1 % full
```

9. Back up the new changes using the `chg-db:action=backup:dest=fixed` command. These messages should appear, the active Maintenance and Administration Subsystem Processor (MASP) appears first.

```
BACKUP (FIXED) : MASP A - Backup starts on active MASP.
BACKUP (FIXED) : MASP A - Backup on active MASP to fixed disk
complete.
BACKUP (FIXED) : MASP A - Backup starts on standby MASP.
BACKUP (FIXED) : MASP A - Backup on standby MASP to fixed disk
complete.
```

Figure A-10 Change the Attributes of a Service Selector Entry for the MO SMS B-Party Routing Feature - Sheet 1 of 2

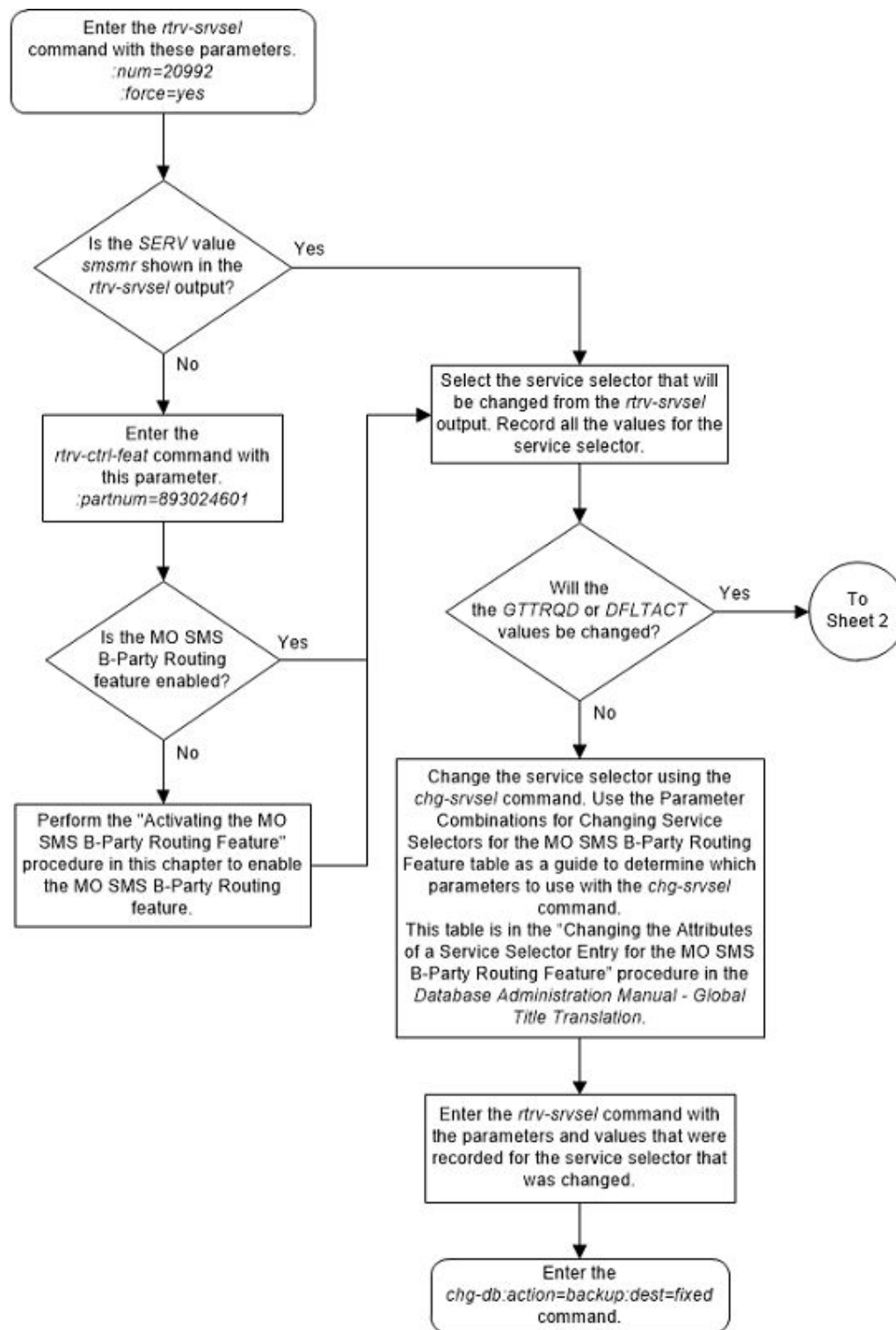
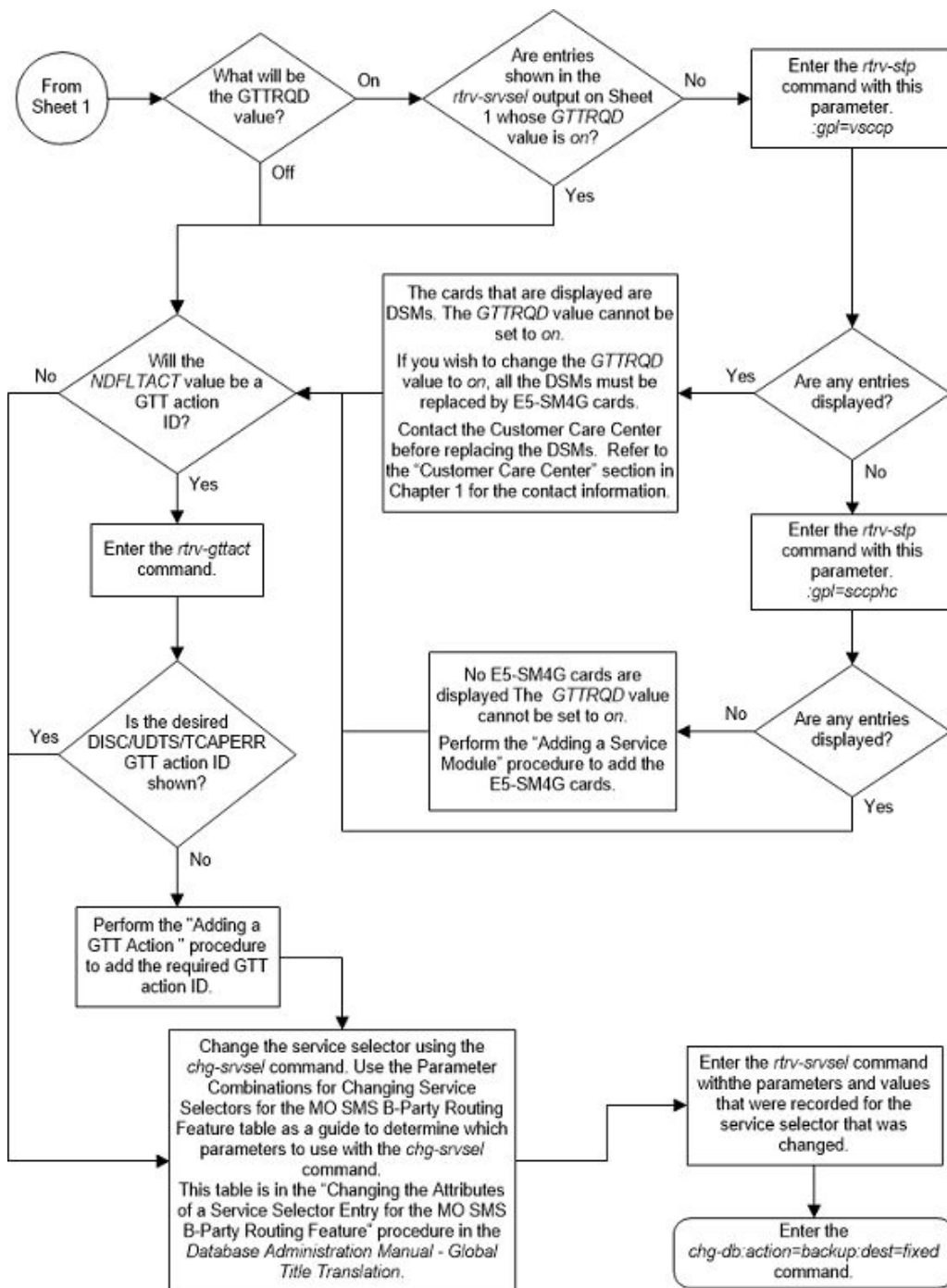

Figure A-11 Change the Attributes of a Service Selector Entry for the MO SMS B-Party Routing Feature - Sheet 2 of 2



Turning the MO SMS B-Party Routing Feature Off

This procedure is used to turn off the MO SMS B-Party Routing feature using the `chg-ctrl-feat` command.

The `chg-ctrl-feat` command uses the following parameters:

:partnum - The part number of the MO SMS B-Party Routing feature, 893024601.
:status=off – used to turn off the MO SMS B-Party Routing feature.

The status of the MO SMS B-Party Routing feature must be on and is shown with the `rtrv-ctrl-feat` command.

▲ Caution:

If the MO SMS B-Party Routing feature is turned off, provisioning for MO SMS B-Party Routing can be performed with the `chg-gsmsmsopts`, `chg-is41smsopts`, `ent-srvsel`, `dlt-srvsel`, and `chg-srvsel` commands. The EAGLE will not perform global title translation on the MAP B-Party digits of the message.

1. Display the status of the MO SMS B-Party Routing feature by entering the `rtrv-ctrl-feat:partnum=893024601` command.

The following is an example of the possible output.

```
rlghncxa03w 08-09-28 21:15:37 GMT EAGLE5 39.1.0
```

The following features have been permanently enabled:

Feature Name	Partnum	Status	Quantity
MO SMS B-Party Routing	893024601	on	----

The following features have been temporarily enabled:

Feature Name	Partnum	Status	Quantity	Trial
Period Left				
Zero entries found.				

The following features have expired temporary keys:

Feature Name	Partnum
Zero entries found.	

If the status of the MO SMS B-Party Routing feature is off, or if the MO SMS B-Party Routing feature is not enabled, this procedure cannot be performed.

2. Turn off the MO SMS B-Party Routing feature by entering the `chg-ctrl-feat` command with the `status=off` parameter.

For example, enter this command.

```
chg-ctrl-feat:partnum=893024601:status=off
```

When this command has successfully completed, the following message should appear.

```
rlghncxa03w 08-09-28 21:16:37 GMT EAGLE5 39.1.0  
CHG-CTRL-FEAT: MASP A - COMPLTD
```

3. Verify the MO SMS B-Party Routing feature has been turned off by using the `rtrv-ctrl-feat:partnum=893024601` command. The following is an example of the possible output.

```
rlghncxa03w 08-09-28 21:15:37 GMT EAGLE5 39.1.0
The following features have been permanently enabled:
```

Feature Name	Partnum	Status	Quantity
MO SMS B-Party Routing	893024601	off	----

The following features have been temporarily enabled:

Feature Name	Partnum	Status	Quantity	Trial Period Left
Zero entries found.				

The following features have expired temporary keys:

Feature Name	Partnum
Zero entries found.	

4. Back up the new changes using the `chg-db:action=backup:dest=fixed` command.

These messages should appear, the active Maintenance and Administration Subsystem Processor (MASP) appears first.

```
BACKUP (FIXED) : MASP A - Backup starts on active MASP.
BACKUP (FIXED) : MASP A - Backup on active MASP to fixed disk
complete.
BACKUP (FIXED) : MASP A - Backup starts on standby MASP.
BACKUP (FIXED) : MASP A - Backup on standby MASP to fixed disk
complete.
```

Figure A-12 Turn the MO SMS B-Party Routing Feature Off

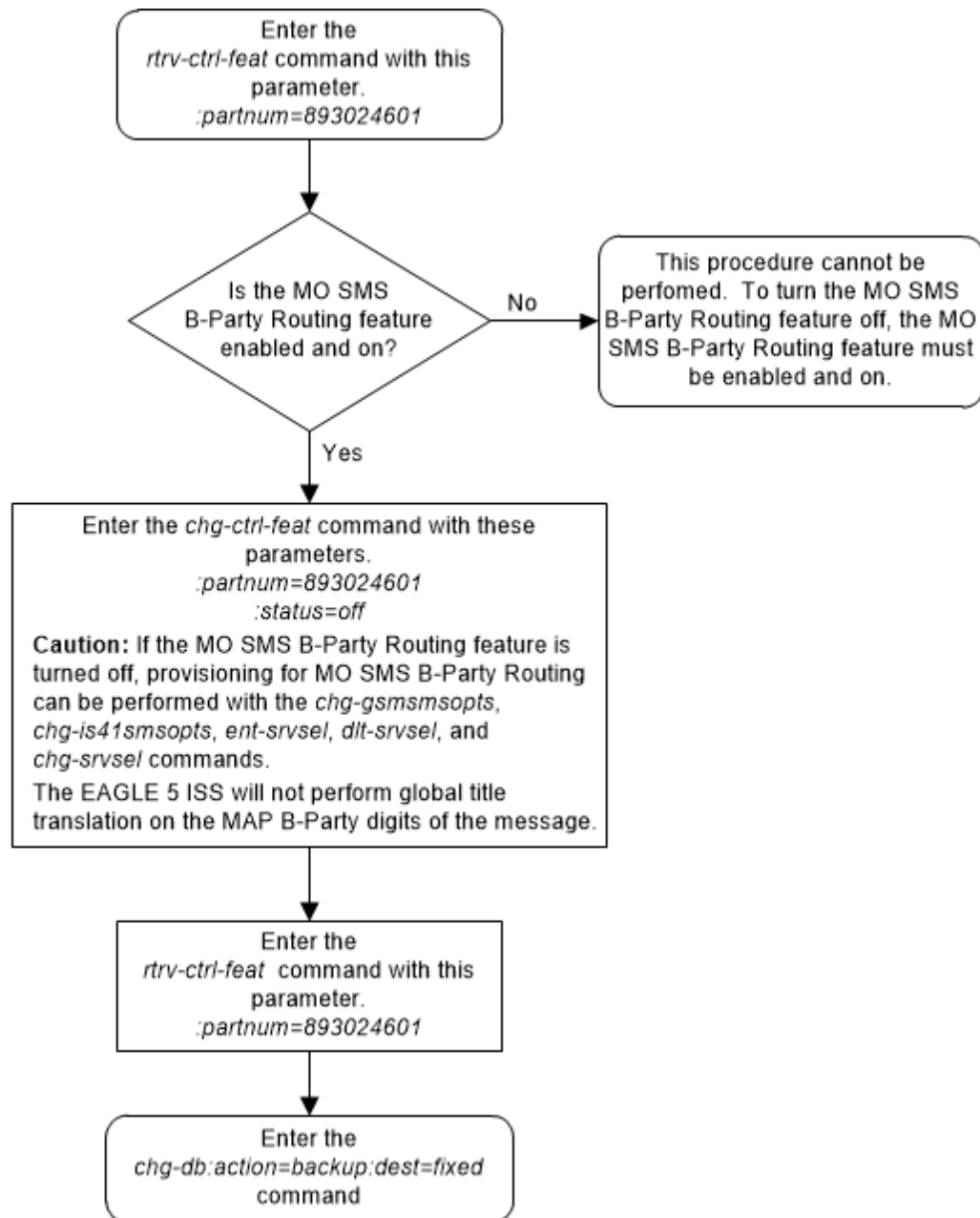

B

MO SMS Prepaid Intercept on B-Party Configuration Procedures

Appendix C, MO SMS Prepaid Intercept on B-Party Configuration Procedures, describes the procedures necessary to configure the EAGLE to redirect MO SMS messages from a prepaid B-party subscriber to a specific **SMSC**.

Introduction

The MO SMS Prepaid Intercept on B-Party feature allows the existing Prepaid Intercept Phase 1 feature to redirect MO SMS messages based on whether the B-Party of the subscriber is prepaid.

Note:

The B-party is checked only if the A-party is not a prepaid subscriber.

Provisioning the MO SMS Prepaid Intercept on B-Party Feature

1. Enable the MO SMS Prepaid Intercept on B-Party feature using the `enable-ctrl-feat` command and turn the MO SMS Prepaid Intercept on B-Party on using the `chg-ctrl-feat` command. Perform the procedure [Activating the Prepaid SMS Intercept Phase 1 Feature](#).
2. Configure the service selectors for the MO SMS Prepaid Intercept on B-Party feature using the `ent-srvsel` command. Perform the procedure [Adding a Service Selector Entry for the MO SMS B-Party Routing Feature](#).
3. Configure entries in the PPSOPTS table for a prepaid portability type using the `chg-ppsopts` command. Perform these procedures.
 - To configure the point code entries in the PPSOPTS table, perform the procedure [Configuring Point Code Entries for the Prepaid SMS Intercept Phase 1 Feature](#).
 - To configure the GTA entries in the PPSOPTS table, perform the procedure [Configuring GTA Entries for the Prepaid SMS Intercept Phase 1 Feature](#).
4. Configure the B-Party check option. Perform the procedure [Configuring the B-Party Check Option for the Prepaid SMS Intercept Phase 1 Feature](#).

Activating the Prepaid SMS Intercept Phase 1 Feature

This procedure is used to enable and turn on the Prepaid SMS Intercept Phase 1 feature.

The feature access key is based on the feature's part number and the serial number of the EAGLE, making the feature access key site-specific.

The `enable-ctrl-feat` command enables the Prepaid SMS Intercept Phase 1 feature by inputting the feature's access key and the feature's part number with these parameters:

`:fak` – The feature access key provided by Oracle. The feature access key contains 13 alphanumeric characters and is not case sensitive

`:partnum` – The Oracle-issued part number of the Prepaid SMS Intercept Phase 1 feature, 893006701.

If the feature is being enabled with a temporary feature access key, the feature must not be in the *in-use*, *expired*, or *unavailable* state.

The `enable-ctrl-feat` command requires that the database contain a valid serial number for the EAGLE, and that this serial number is locked. This can be verified with the `rtrv-serial-num` command. The EAGLE is shipped with a serial number in the database, but the serial number is not locked. The serial number can be changed, if necessary, and locked once the EAGLE is on-site, with the `ent-serial-num` command. The `ent-serial-num` command uses these parameters.

`:serial` – The serial number assigned to the EAGLE. The serial number is not case sensitive.

`:lock` – Specifies whether or not the serial number is locked. This parameter has only one value, `yes`, which locks the serial number. Once the serial number is locked, it cannot be changed.

 **Note:**

To enter and lock the EAGLE's serial number, the `ent-serial-num` command must be entered twice, once to add the correct serial number to the database with the `serial` parameter, then again with the `serial` and the `lock=yes` parameters to lock the serial number. You should verify that the serial number in the database is correct before locking the serial number. The serial number can be found on a label affixed to the control shelf (shelf 1100).

Once the feature has been enabled, the feature must be activated with the `chg-ctrl-feat` command. The `chg-ctrl-feat` command uses these parameters:

`:partnum` – The Oracle-issued part number of the Prepaid SMS Intercept Phase 1 feature, 893006701.

`:status=on` – used to turn the Prepaid SMS Intercept Phase 1 feature on.

The status of the features in the EAGLE is shown with the `rtrv-ctrl-feat` command.

The Prepaid SMS Intercept Phase 1 requires that DSM or SLIC cards are installed and provisioned in the EAGLE. The `rtrv-stp` command can be used to verify if DSMs or SLIC cards are provisioned in the database. Specifying the `type=dsm` (the SLIC must be in odd numbered card slots) or `type=slic` (the SLIC in the even numbered card slots) parameter with the `rtrv-stp` command displays the DSM or SLIC cards.

1. Display the status of the Prepaid SMS Intercept Phase 1 feature by entering the `rtrv-ctrl-feat` command.

The following is an example of the possible output.

```
rlghncxa03w 08-09-28 21:15:37 GMT EAGLE5 39.1.0
The following features have been permanently enabled:
```

Feature Name	Partnum	Status	Quantity
Command Class Management	893005801	on	----
Intermed GTT Load Sharing	893006701	off	----
XGTT Table Expansion	893006101	off	----
XMAP Table Expansion	893007710	on	3000
Large System # Links	893005910	on	2000
Routesets	893006401	on	6000
HC-MIM SLK Capacity	893012707	on	64

The following features have been temporarily enabled:

Feature Name	Partnum	Status	Quantity	Trial Period Left
Zero entries found.				

The following features have expired temporary keys:

Feature Name	Partnum
Zero entries found.	

If the `rtrv-ctrl-feat` output shows that the Prepaid SMS Intercept Phase 1 feature is permanently enabled, and its status is `on`, no further action is necessary.

If the Prepaid SMS Intercept Phase 1 feature is permanently enabled, and its status is `off`, continue the procedure with [10](#).

If the Prepaid SMS Intercept Phase 1 feature is temporarily enabled, and you wish to permanently enable this feature, or the temporary feature access key for that feature has expired, continue the procedure with [9](#).

If the Prepaid SMS Intercept Phase 1 feature is to remain temporarily enabled, and its status is `off`, continue the procedure with [10](#). If the feature's status is `on`, no further action is necessary.

If the Prepaid SMS Intercept Phase 1 feature is to remain temporarily enabled, and its status is `on`, no further action is necessary.

If the Prepaid SMS Intercept Phase 1 feature is not enabled, continue the procedure with [2](#).

2. If the `rtrv-ctrl-feat` output in [1](#) shows any controlled features, continue the procedure with [9](#). If the `rtrv-ctrl-feat` output shows only the HC-MIM SLK Capacity feature with a quantity of 64, [3](#) through [6](#) must be performed.
3. Display the serial number in the database with the `rtrv-serial-num` command. This is an example of the possible output.

```
rlghncxa03w 08-09-28 21:15:37 GMT EAGLE5 39.1.0
System serial number = nt00001231
```

System serial number is not locked.

```
rlghncxa03w 08-09-28 21:15:37 GMT EAGLE5 39.1.0
Command Completed.
```

 **Note:**

If the serial number is correct and locked, continue the procedure with 7. If the serial number is correct but not locked, continue the procedure with 6. If the serial number is not correct, but is locked, this feature cannot be enabled and the remainder of this procedure cannot be performed. Contact My Oracle Support to get an incorrect and locked serial number changed. Refer to [#unique_17](#) for the contact information. The serial number can be found on a label affixed to the control shelf (shelf 1100).

4. Enter the correct serial number into the database using the `ent-serial-num` command with the `serial` parameter.

For this example, enter this command.

```
ent-serial-num:serial=<EAGLE's correct serial number>
```

When this command has successfully completed, the following message should appear.

```
rlghncxa03w 08-09-28 21:15:37 GMT EAGLE5 39.1.0
ENT-SERIAL-NUM: MASP A - COMPLTD
```

5. Verify the serial number entered into was entered correctly using the `rtrv-serial-num` command. This is an example of the possible output.

```
rlghncxa03w 08-09-28 21:15:37 GMT EAGLE5 39.1.0
System serial number = nt00001231
```

System serial number is not locked.

```
rlghncxa03w 08-09-28 21:15:37 GMT EAGLE5 39.1.0
Command Completed.
```

If the serial number was not entered correctly, repeat and re-enter the correct serial number.

6. Lock the serial number in the database by entering the `ent-serial-num` command with the serial number shown in , if the serial number shown in is correct, or with the serial number shown in , if the serial number was changed in , and with the `lock=yes` parameter.

For this example, enter this command.

```
ent-serial-num:serial=<EAGLE's serial number>:lock=yes
```

When this command has successfully completed, the following message should appear.

```
rlghncxa03w 08-09-28 21:15:37 GMT EAGLE5 39.1.0
ENT-SERIAL-NUM: MASP A - COMPLTD
```

- Verify that the GTT feature is on, by entering the `rtrv-feat` command. If the GTT feature is on, the `GTT` field should be set to `on`.

 **Note:**

The `rtrv-feat` command output contains other fields that are not used by this procedure. If you wish to see all the fields displayed by the `rtrv-feat` command, see the `rtrv-feat` command description in *Commands User's Guide*.

If the GTT feature is not on, perform [Adding a Service Module](#) to turn the GTT feature on and add DSMs or SLIC cards to the EAGLE. After the GTT feature is turned on and the DSMs or SLIC cards have been added, continue the procedure with [9](#).

If the GTT feature is on, continue the procedure with [8](#).

- Display any DSMs or SLIC cards by entering one of the following commands, respectively:

```
rtrv-stp:type=dsm
```

```
rtrv-stp:type=slic
```

This is an example of the possible output if DSMs or SLIC cards are provisioned in the database.

```
rlghncxa03w 08-09-28 21:15:37 GMT EAGLE5 39.1.0
```

Card Version	Part Number	Rev	Serial Number	Type	DB	APPL	GPL
1105	870-1275-03	W	10245689323	DSM	40696M	VSCCP	
027-010-000							
1214	870-1275-03	W	10245689333	DSM	40696M	VSCCP	
027-010-000							
2107	870-1275-03	W	10245689343	DSM	40696M	VSCCP	
027-010-000							

Command Completed.

This is an example of the possible output if there are no DSMs or SLIC cards provisioned in the database.

```
rlghncxa03w 08-09-28 21:15:37 GMT EAGLE5 39.1.0
```

Card Version	Part Number	Rev	Serial Number	Type	DB	APPL	GPL

Command Completed.

If no DSMs or SLIC cards are shown in this step, perform [Adding a Service Module](#) to add an E5-SM8G-B cards. After the cards have been added, continue the procedure with 9.

If cards are shown in this step, continue the procedure with 9.

9. Enable the Prepaid SMS Intercept Phase 1 feature with either a permanent key or temporary key by entering the `enable-ctrl-feat` command. For this example, enter this command.

```
enable-ctrl-feat:partnum=893006701
```

When the `enable-ctrl-feat` command has successfully completed, this message should appear.

```
rlghncxa03w 08-09-28 21:15:37 GMT EAGLE5 39.1.0
ENABLE-CTRL-FEAT: MASP B - COMPLTD
```

10. The Prepaid SMS Intercept Phase 1 feature must be turned on using the `chg-ctrl-feat` command, specifying the Prepaid SMS Intercept Phase 1 feature part number and the `status=on` parameter. For this example, enter this command.

```
chg-ctrl-feat:partnum=893006701:status=on
```

When this command has successfully completed, the following message should appear.

```
rlghncxa03w 08-09-28 21:15:37 GMT EAGLE5 39.1.0
CHG-CTRL-FEAT: MASP B - COMPLTD
```

11. Verify the changes by entering the `rtrv-ctrl-feat` command with the Prepaid SMS Intercept Phase 1 part number. Enter this command.

```
rtrv-ctrl-feat:partnum=893006701
```

The following is an example of the possible output.

```
rlghncxa03w 08-09-28 21:15:37 GMT EAGLE5 39.1.0
The following features have been permanently enabled:
```

Feature Name	Partnum	Status	Quantity
Prepaid SMS Intercept Ph1	893006701	on	----

The following features have been temporarily enabled:

Feature Name	Partnum	Status	Quantity	Trial
Period Left				
Zero entries found.				

The following features have expired temporary keys:

Feature Name	Partnum
Zero entries found.	

12. Back up the new changes using the `chg-db:action=backup:dest=fixed` command.

These messages should appear, the active Maintenance and Administration Subsystem Processor (MASP) appears first.

```

    BACKUP (FIXED) : MASP A - Backup starts on active MASP.
    BACKUP (FIXED) : MASP A - Backup on active MASP to fixed disk
    complete.
    BACKUP (FIXED) : MASP A - Backup starts on standby MASP.
    BACKUP (FIXED) : MASP A - Backup on standby MASP to fixed disk
    complete.
    
```

Figure B-1 Activate the Prepaid SMS Intercept Phase 1 Feature - Sheet 1 of 3

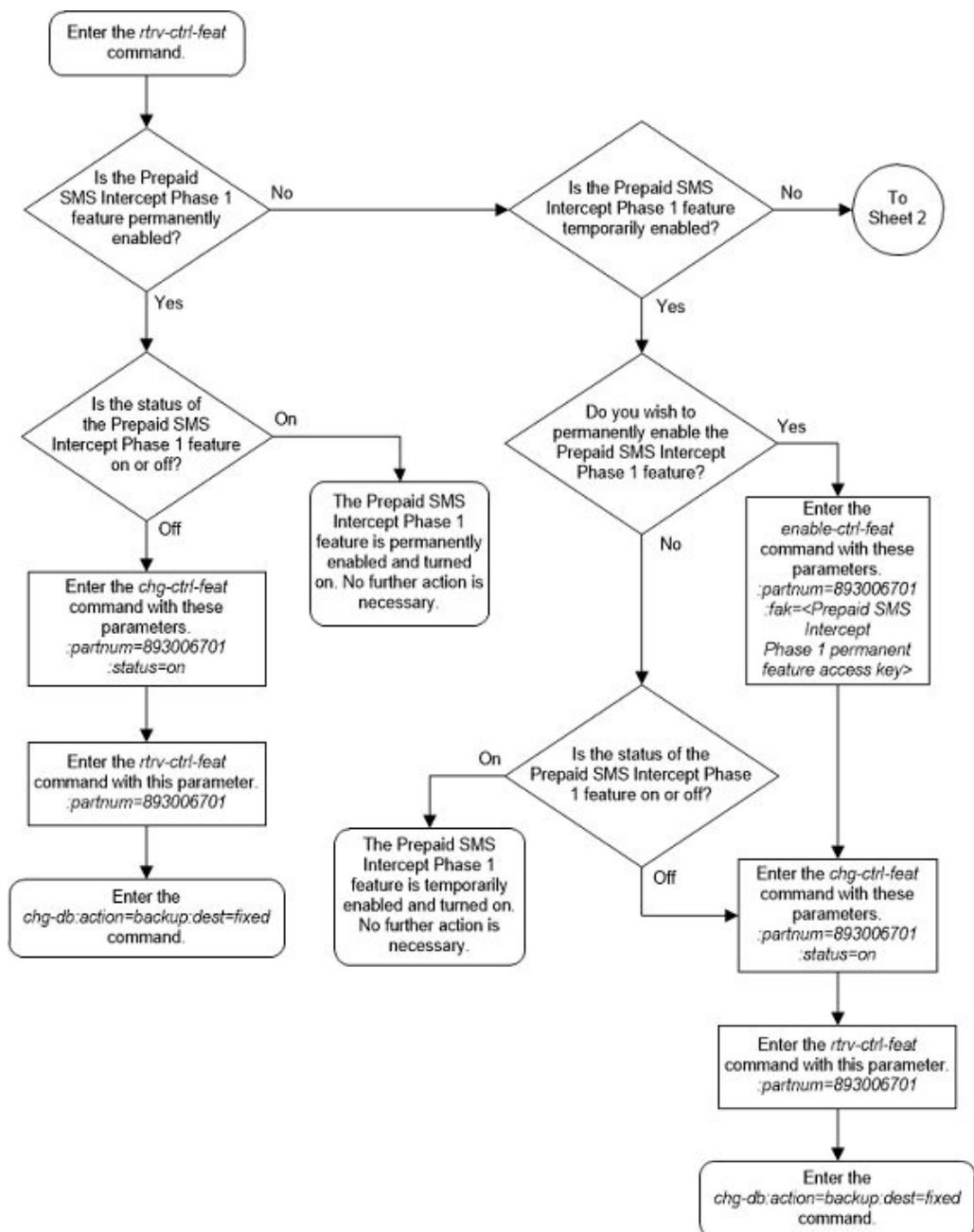

Figure B-2 Activate the Prepaid SMS Intercept Phase 1 Feature - Sheet 2 of 3

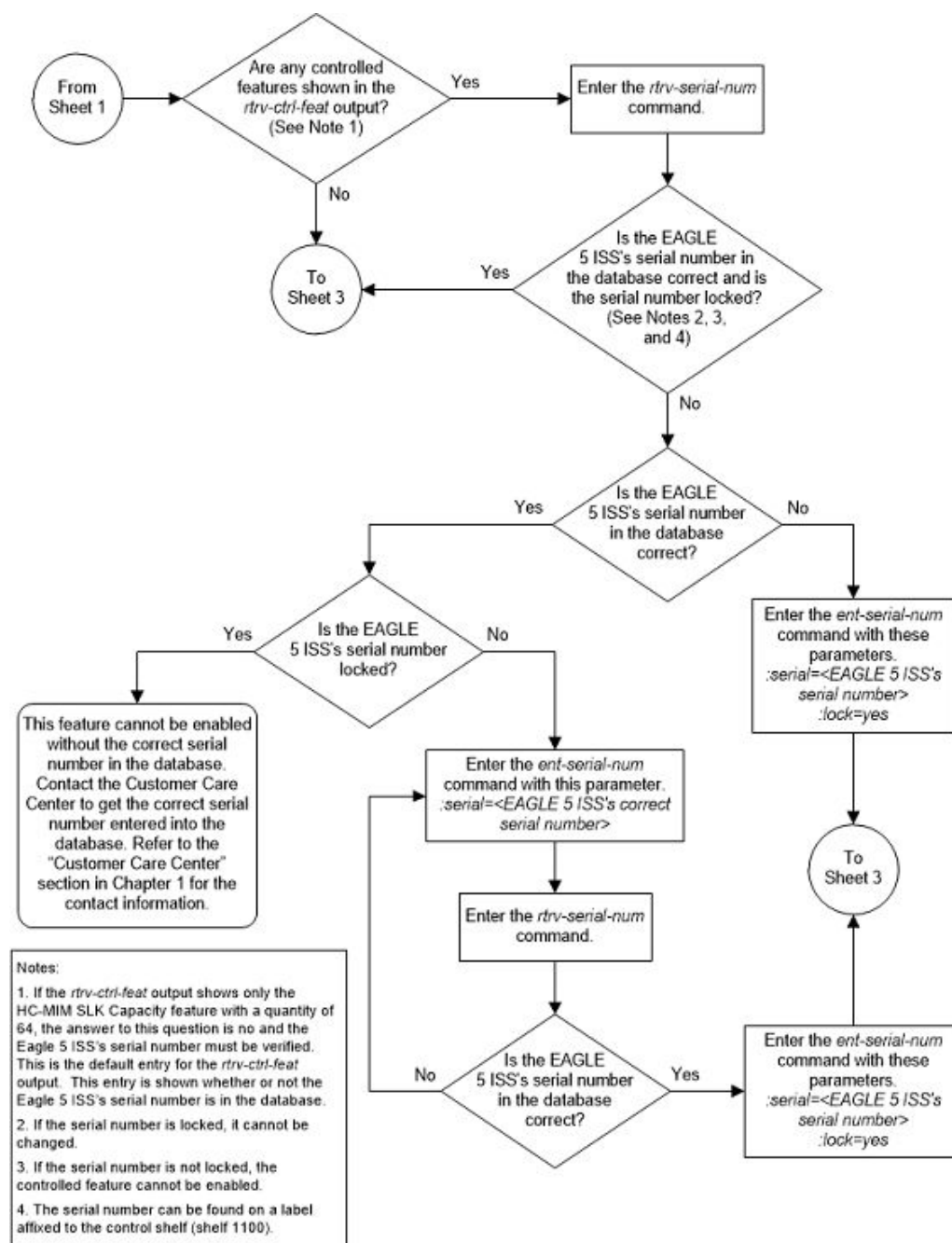
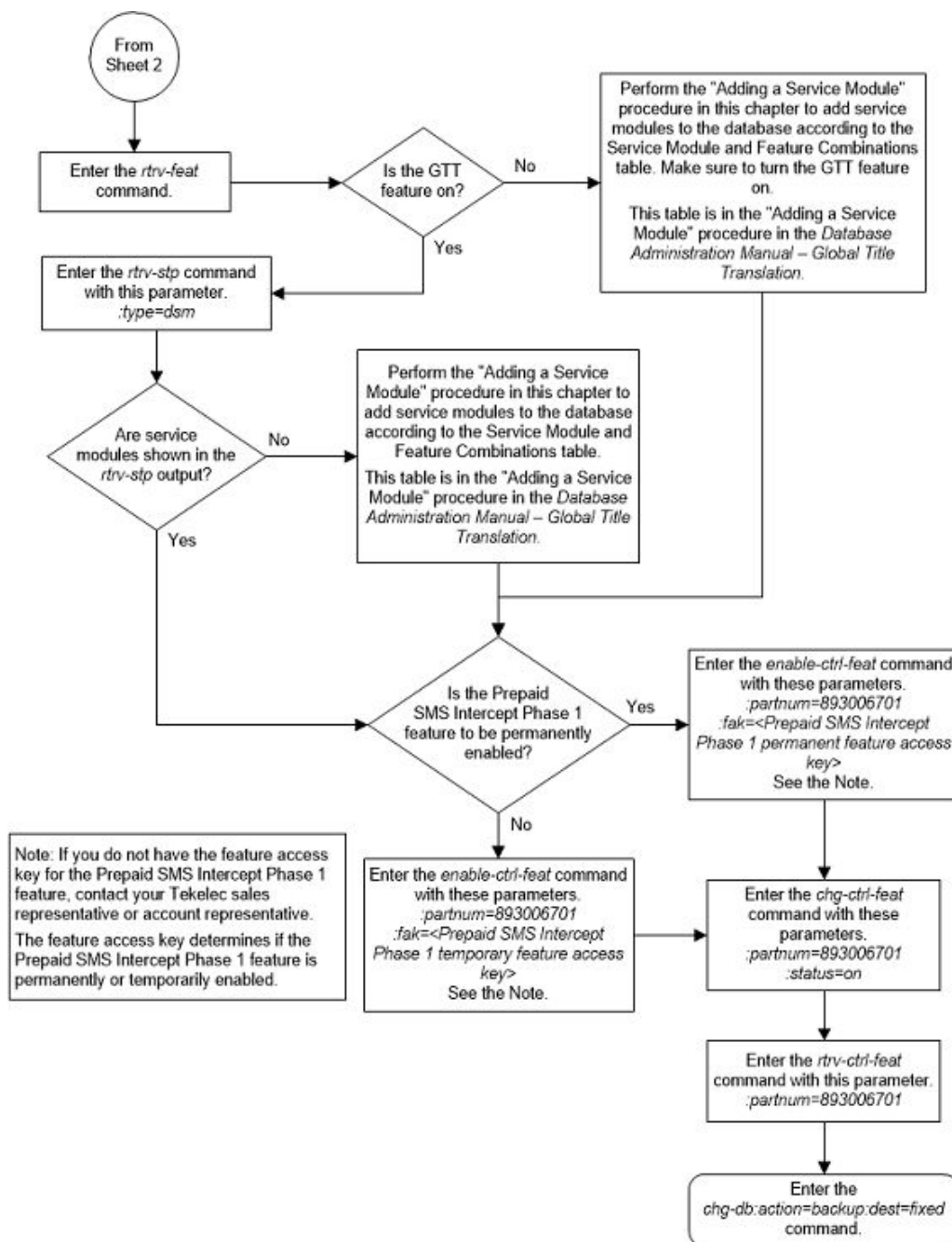

Figure B-3 Activate the Prepaid SMS Intercept Phase 1 Feature - Sheet 3 of 3



Configuring the B-Party Check Option for the Prepaid SMS Intercept Phase 1 Feature

This procedure is used to configure the B-Party check option shown in the `rtrv-ppsopts` command output using the `bpartychk` parameter of the `chg-ppsopts` command. The `bpartychk` parameter has two values:

- off — Prepaid Check on B-Party is not performed

- on — Prepaid Check on B-Party is performed.

Point code and global title address (GTA) entries can also be configured with the `chg-ppsopts` command. Perform the procedure [Configuring Point Code Entries for the Prepaid SMS Intercept Phase 1 Feature](#) to configure the point code entries. Perform the procedure [Configuring GTA Entries for the Prepaid SMS Intercept Phase 1 Feature](#) to configure the GTA entries.

The Prepaid SMS Intercept Phase 1 feature must be enabled and turned on before this procedure can be performed. The status of the Prepaid SMS Intercept Phase 1 feature can be verified by entering the `rtrv-ctrl-feat` command. Perform the procedure [Activating the Prepaid SMS Intercept Phase 1 Feature](#) to enable and turn on the Prepaid SMS Intercept Phase 1 feature, if necessary.

1. Display the status of the Prepaid SMS Intercept Phase 1 feature by entering this command.

```
rtrv-ctrl-feat:partnum=893006701
```

The following is an example of the possible output.

```
rlghncxa03w 08-09-28 21:15:37 GMT EAGLE5 39.1.0
The following features have been permanently enabled:
```

Feature Name	Partnum	Status	Quantity
Prepaid SMS Intercept Ph1	893006701	on	----

The following features have been temporarily enabled:

Feature Name	Partnum	Status	Quantity	Trial
Period Left				
Zero entries found.				

The following features have expired temporary keys:

Feature Name	Partnum
Zero entries found.	

If the Prepaid SMS Intercept Phase 1 feature is enabled and turned on, continue the procedure with [2](#).

If the Prepaid SMS Intercept Phase 1 feature is not enabled or not turned on, perform the procedure [Activating the Prepaid SMS Intercept Phase 1 Feature](#) to enable and turn on the Prepaid SMS Intercept Phase 1 feature. After the Prepaid SMS Intercept Phase 1 feature has been enabled and turned on, continue the procedure with [2](#).

2. Display the current `BPARTYCHK` value in the `rtrv-ppsopts` output by entering this command.

```
rtrv-ppsopts:ppt=1
```

This is an example of the possible output.

```
rlghncxa03w 09-03-07 00:34:31 GMT EAGLE5 40.1.0
Prepaid SMS Options
-----
BPARTYCHK      = ON
```

PPT	PCA/PCI/PCN	SSN	RI
---	-----	---	---
1	PCA: 001-001-002	NONE	SSN

3. Configure the BPARTYCHK value by entering one of these commands.

If the current BPARTYCHK value is `on`, enter this command.

```
chg-ppsopts:bpartychk=off
```

If the current BPARTYCHK value is `off`, enter this command.

```
chg-ppsopts:bpartychk=on
```

When the `chg-ppsopts` command has successfully completed, this message should appear.

```
rlghncxa03w 08-09-07 11:44:13 GMT EAGLE5 39.1.0
CHG-PPSOPTS: MASP A - COMPLTD
```

4. Verify the changes by entering this command.

```
rtrv-ppsopts:ppt=1
```

This is an example of the possible output.

```
rlghncxa03w 09-03-07 00:34:31 GMT EAGLE5 40.1.0
Prepaid SMS Options
-----
BPARTYCHK      = OFF
PPT            PCA/PCI/PCN                SSN      RI
---            -----                ---      ---
1              PCA: 001-001-002                NONE     SSN
```

5. Back up the new changes using the `chg-db:action=backup:dest=fixed` command. These messages should appear, the active Maintenance and Administration Subsystem Processor (MASP) appears first.

```
BACKUP (FIXED) : MASP A - Backup starts on active MASP.
BACKUP (FIXED) : MASP A - Backup on active MASP to fixed disk
complete.
BACKUP (FIXED) : MASP A - Backup starts on standby MASP.
BACKUP (FIXED) : MASP A - Backup on standby MASP to fixed disk
complete.
```

If you do not wish to configure point code and global title address (GTA) entries in the PPSOPTS table, this procedure is finished.

If you wish to configure point code and global title address (GTA) entries in the PPSOPTS table, perform these procedures as applicable.

- To configure point code entries, perform the procedure [Configuring Point Code Entries for the Prepaid SMS Intercept Phase 1 Feature](#).
- To configure GTA entries, perform the procedure [Configuring GTA Entries for the Prepaid SMS Intercept Phase 1 Feature](#).

Figure B-4 Configure the B-Party Check Option for the Prepaid SMS Intercept Phase 1 Feature

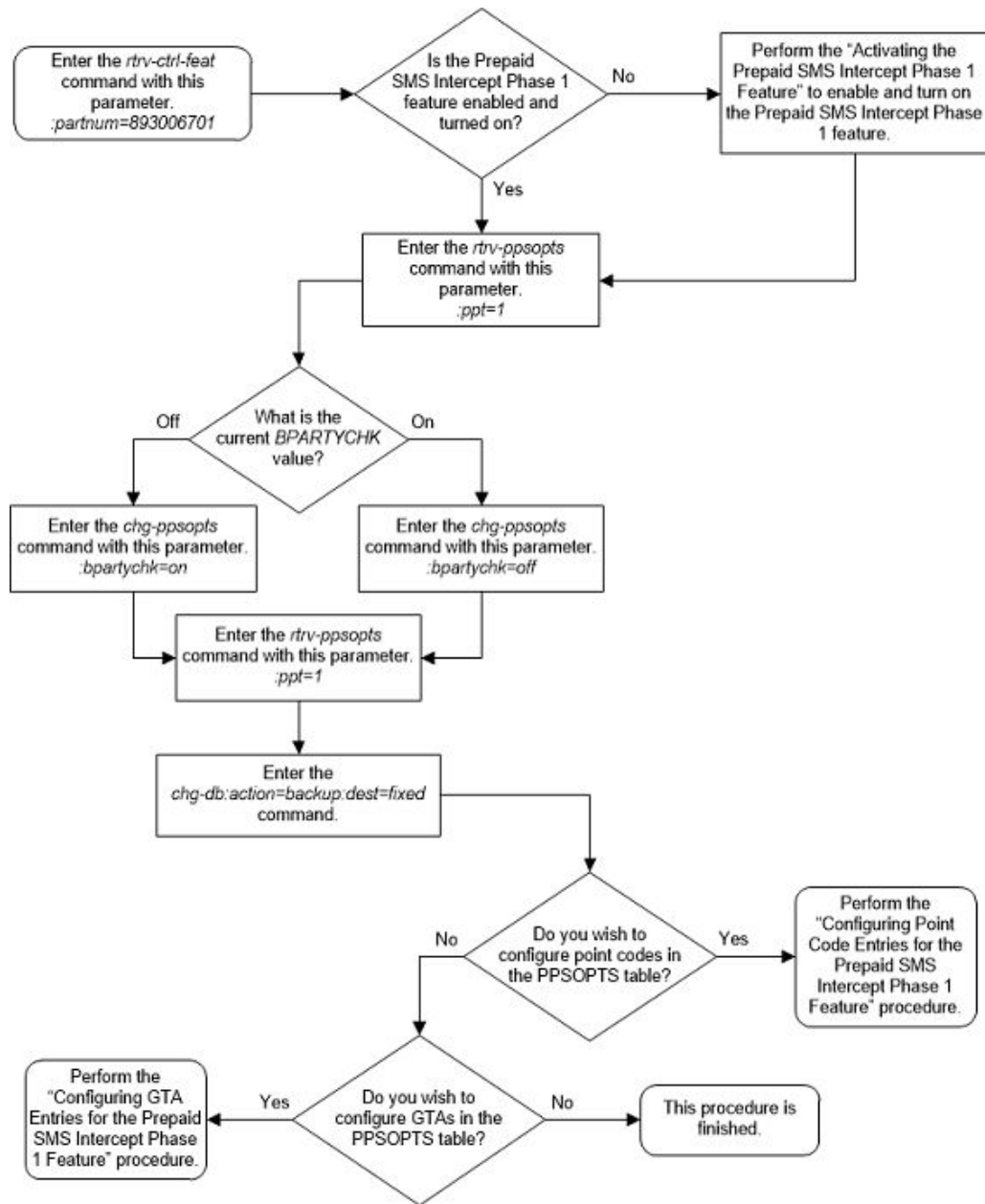

Configuring Point Code Entries for the Prepaid SMS Intercept Phase 1 Feature

This procedure is used to add point code entries to the PPSOPTS table, or remove point code entries from the PPSOPTS table using these parameters of the `chg-ppsopts` command.

`:ppt` – The prepaid portability type number of the entry that is being changed, from 1 to 32.

:*pc/pca/pci/pcn* – The point code for the IN platform, or the value *none*. The value *none* removes the point code from the entry that is being changed.

- *pc/pca* - An ANSI point code
- *pci* - An ITU-I point code
- *pcn* - A 14-bit ITU-N point code

 **Note:**

Refer to Chapter 2, Configuring Destination Tables in *Database Administration - SS7 User's Guide* for a definition of the point code types that are used on the EAGLE and for a definition of the different formats that can be used for ITU national point codes.

:*ri* – The routing indicator for the IN platform

- *gt* - Routes on the GT value. If the Intermediate Global Title Loadsharing feature is enabled and turned on, the mated relay node (MRN) table is used to determine how the message is routed. If the Intermediate Global Title Loadsharing feature is not enabled or not turned on, the message is routed to the point code in the entry that is being changed.
- *ssn* - Routes on the SSN value. The mated application (MAP) table determines how the message is routed.

:*setid* – The MRN set or MAP set ID that contains the point code in the entry that is being changed. This parameter can be specified only if the Flexible GTT Load Sharing feature is enabled. This parameter must be specified if the Flexible GTT Load Sharing feature is enabled. If the Flexible GTT Load Sharing feature is enabled, the point code must be in the MRN set or MAP set specified by the *setid* parameter. If the *ssn* parameter is specified with the *ri=ssn* parameter, the point code and SSN value must be in the MAP set specified by the *setid* parameter.

:*ssn* - The subsystem number that is assigned to the point code entry. The values for this parameter are 2 - 255, or *none*. The value *none* removes the existing subsystem number from the point code entry. The default value for this parameter is *none*.

[Table B-1](#) shows the parameter combinations that can be used in this procedure.

Table B-1 CHG-PPSOPTS Parameter Combinations

Adding a Point Code Entry	Removing a Point Code or SSN Entry
: <i>ppt</i> = the prepaid portability type that is being changed	: <i>ppt</i> = the prepaid portability type that is being changed
: <i>pc/pca/pci/pcn</i> = the point code value that is being added	: <i>pc/pca/pci/pcn</i> = <i>none</i>
: <i>ri</i> = <i>gt, ssn</i>	: <i>ssn</i> = <i>none</i>
: <i>setid</i> = the MRN or MAP set ID containing the point code	
: <i>ssn</i> = 2 - 255	

Global title address (GTA) entries and the B-Party check option can also be configured with the *chg-ppsopts* command. Perform [Configuring the B-Party Check Option for](#)

the [Prepaid SMS Intercept Phase 1 Feature](#) to configure the B-Party check option. Perform [Configuring GTA Entries for the Prepaid SMS Intercept Phase 1 Feature](#) to configure the GTA entries.

The Prepaid SMS Intercept Phase 1 feature must be enabled and turned on before this procedure can be performed. The status of the Prepaid SMS Intercept Phase 1 feature can be verified by entering the `rtrv-ctrl-feat` command. Perform [Activating the Prepaid SMS Intercept Phase 1 Feature](#) to enable and turn on the Prepaid SMS Intercept Phase 1 feature, if necessary.

The point code that will be specified in this procedure must be the DPC of a route. This can be verified by entering the `rtrv-rte` command with the `dpca/dpci/dpcn` parameter. The `dpca/dpci/dpcn` parameter value must be the point code that will be specified in this procedure.

Canceling the RTRV-MRN and RTRV-MAP Commands

Because the `rtrv-mrn` and `rtrv-map` commands used in this procedure can output information for a long period of time, the `rtrv-mrn` and `rtrv-map` commands can be canceled and the output to the terminal stopped. There are three ways that the `rtrv-mrn` and `rtrv-map` commands can be canceled.

- Press the F9 function key on the keyboard at the terminal where the `rtrv-mrn` and `rtrv-map` commands were entered.
- Enter the `canc-cmd` without the `trm` parameter at the terminal where the `rtrv-mrn` and `rtrv-map` commands were entered.
- Enter the `canc-cmd:trm=<xx>`, where `<xx>` is the terminal where the `rtrv-mrn` and `rtrv-map` commands were entered, from another terminal other than the terminal where the `rtrv-mrn` and `rtrv-map` commands were entered. To enter the `canc-cmd:trm=<xx>` command, the terminal must allow Security Administration commands to be entered from it and the user must be allowed to enter Security Administration commands. The terminal's permissions can be verified with the `rtrv-secu-trm` command. The user's permissions can be verified with the `rtrv-user` or `rtrv-secu-user` commands.

For more information about the `canc-cmd` command, refer to *Commands User's Guide*.

1. Display the status of the Prepaid SMS Intercept Phase 1 feature by entering this command.

```
rtrv-ctrl-feat:partnum=893006701
```

The following is an example of the possible output.

```
rlghncxa03w 08-09-28 21:15:37 GMT EAGLE5 39.1.0
The following features have been permanently enabled:
```

Feature Name	Partnum	Status	Quantity
Prepaid SMS Intercept Ph1	893006701	on	----

The following features have been temporarily enabled:

Feature Name	Partnum	Status	Quantity	Trial
Period Left				
Zero entries found.				

The following features have expired temporary keys:

```
Feature Name          Partnum
Zero entries found.
```

If the Prepaid SMS Intercept Phase 1 feature is enabled and turned on, continue the procedure with 2.

If the Prepaid SMS Intercept Phase 1 feature is not enabled or not turned on, perform [Activating the Prepaid SMS Intercept Phase 1 Feature](#) to enable and turn on the Prepaid SMS Intercept Phase 1 feature. After the Prepaid SMS Intercept Phase 1 feature has been enabled and turned on, continue the procedure with 2.

2. Display the PPSOPTS table by entering the `rtrv-ppsopts` command. This is an example of the possible output.

```
rlghncxa03w 09-03-07 00:34:31 GMT EAGLE5 40.1.0
Prepaid SMS Options
-----
BPARTYCHK          = ON
PPT          PCA/PCI/PCN          SSN          RI          Set ID
---          -
1          PCA:    001-001-002          NONE          SSN          1
2          PCA:    001-002-003          NONE          GT          1
3          -----          NONE          GT          DFLT
4          -----          NONE          GT          DFLT
5          -----          NONE          GT          DFLT
6          -----          NONE          GT          DFLT
7          -----          NONE          GT          DFLT
8          -----          NONE          GT          DFLT
9          -----          NONE          GT          DFLT
10         -----          NONE          GT          DFLT
11         -----          NONE          GT          DFLT
12         -----          NONE          GT          DFLT
13         -----          NONE          GT          DFLT
14         -----          NONE          GT          DFLT
15         -----          NONE          GT          DFLT
16         -----          NONE          GT          DFLT
17         -----          NONE          GT          DFLT
18         -----          NONE          GT          DFLT
19         -----          NONE          GT          DFLT
20         -----          NONE          GT          DFLT
21         -----          NONE          GT          DFLT
22         -----          NONE          GT          DFLT
23         -----          NONE          GT          DFLT
24         -----          NONE          GT          DFLT
25         -----          NONE          GT          DFLT
26         -----          NONE          GT          DFLT
27         -----          NONE          GT          DFLT
28         -----          NONE          GT          DFLT
29         -----          NONE          GT          DFLT
30         -----          NONE          GT          DFLT
31         -----          NONE          GT          DFLT
32         -----          NONE          GT          DFLT
```

RTX:No

CLLI:-----

If the new point code value is the DPC of a route, continue the procedure with 4.

If the new point code value is not the DPC of a route, perform one of the Adding a Route procedures in *Database Administration - SS7 User's Guide* to add the required route with the new point code value as the DPC of the route. A proxy point code cannot be assigned to the DPC of the route. After the new route has been added, continue the procedure by performing one of these actions.

- If the routing indicator of the entry that is being changed will be `gt`, and the `SETID` column not is shown in the `rtrv-ppsopts` output, continue the procedure with 7.
- If the routing indicator of the entry that is being changed will be `gt`, and the `SETID` column is shown in the `rtrv-ppsopts` output, continue the procedure with 5.
- If the routing indicator of the entry that is being changed will be `ssn`, continue the procedure with 6.

If the new point code value is the DPC of a route, or if a new route was added, continue the procedure by performing one of these actions.

4. Display the attributes of the DPC of the route shown in 3 by using the `rtrv-dstn` command and specifying the DPC of the route. For this example, enter this command.

```
rtrv-dstn:dpca=001-001-004
```

This is an example of the possible output.

```
rlghncxa03w 10-12-10 11:43:04 GMT EAGLE5 43.0.0
```

DPCA	CLLI	BEI	ELEI	ALIASI					
ALIASN/N24	DMN								
001-001-004	-----	no	---	-----					
-----	SS7								
SPCA	NCAI	RCAUSE	NPRST	SPLITIAM	HMSMSC	HMSCP			
SCCPMSGCNV									
-----	----	none	off	none	no	no	none		

```
Destination table is (14 of 2000) 1% full
```

```
Alias table is (0 of 12000) 0% full
```

A proxy point code (a point code value is shown in the `PPC` column) cannot be assigned to the point code that will be added in this procedure,. If a proxy point code is shown in this step, choose another point code and repeat 3 and 4.

If a proxy point code is not assigned to the point code that will be added in this procedure, continue the procedure by performing one of these actions.

- If the routing indicator of the entry that is being changed will be `gt`, and the `SETID` column not is shown in the `rtrv-ppsopts` output, continue the procedure with 7.

- If the routing indicator of the entry that is being changed will be `gt`, and the `SETID` column is shown in the `rtrv-ppsopts` output, continue the procedure with [5](#).
 - If the routing indicator of the entry that is being changed will be `ssn`, continue the procedure with [6](#).
5. Display the MRN entries in the database by entering the `rtrv-mrn` command.

This is an example of the possible output.

```
rlghncxa03w 08-09-07 00:34:31 GMT EAGLE5 39.1.0
```

MRNSET	PC	RC
1	001-001-002	1
	001-001-003	2

```
MRN table is (2 of 6000) 1% full
```

If the new point code value is not shown in the `rtrv-mrn` output, perform [Provisioning MRN Entries](#) to add the new point code to an MRN set. After the MRN set has been added, continue the procedure with [7](#).

If the new point code value is shown in the `rtrv-mrn` output, continue the procedure with [7](#).

6. Display the MAP entries in the database by entering the `rtrv-map` command with the appropriate `pc` parameter, according to the point code format, and the new point code. If the `ssn` parameter will be specified with the `chg-ppsopts` command, specify the `ssn` parameter and value with the `rtrv-map` command, along with the appropriate `pc` parameter. For this example, enter this command.

```
rtrv-map:pca=001-001-004:ssn=25
```

This is an example of the possible output.

```
rlghncxa03w 09-07-07 00:34:31 GMT EAGLE5 41.1.0
```

MAPSET ID=2	PCA	Mate PCA	SSN	RC	MULT	SRM	MRC	GRP	NAME	SSO
	001-001-004		25	10	SOL	*Y	*Y	-----		OFF

```
MAP table is (3 of 36000) 1% full.
```

If the Flexible GTT Load Sharing feature is not enabled, the `MAPSET ID` row is not shown in the `rtrv-map` output, and the MAP table capacity is either 1024, 2000, or 3000.

If the new point code value is not shown in the `rtrv-map` output, perform the one of the Provisioning a Mated Application procedures in [Global Title Translation \(GTT\) Overview](#) to add the new point code to a MAP group or a MAP set. After the point code has been added to the MAP group or MAP set, continue the procedure with [7](#). If the `ssn` parameter will be specified with the `chg-ppsopts` command, the new SSN value must be specified with the new point code value.

If the new point code value and SSN value if required, is shown in the `rtrv-map` output, continue the procedure with [7](#).

7. Configure the point code entry by entering the `chg-ppsopts` command. Perform one of these substeps.

- a. If a point code or SSN entry is being removed from the PPSOPTS table, enter the `chg-ppsopts` command with the prepaid portability type and the appropriate `pc` parameter, according to the point code format, with the value `none`. If the SSN entry is being removed, the `ssn=none` parameter must be specified with the `chg-ppsopts` command. For this example, enter one of these commands.

```
chg-ppsopts:ppt=1:pca=none
```

```
chg-ppsopts:ppt=1:ssn=none
```

```
chg-ppsopts:ppt=1:pca=none:ssn=none
```

- b. If a point code entry is being added to the PPSOPTS table, and the routing indicator value will be `gt`, enter the `chg-ppsopts` command with these parameters.

- The prepaid portability type - `ppt`
- The appropriate `pc` parameter and value, according to the point code format
- The `ri=gt` parameter
- If the `SETID` column is shown in the `rtrv-ppsopts` output in 2, the `setid` parameter must be specified with the `chg-ppsopts` command. The `setid` parameter value must be the MRN set ID that contains the point code value.
- The `ssn` parameter can be specified for this entry.

For this example, enter this command.

```
chg-ppsopts:ppt=3:pca=001-001-004:ri=gt:setid=2
```

- c. If a point code entry is being added to the PPSOPTS table, and the routing indicator value will be `ssn`, enter the `chg-ppsopts` command with these parameters.

- The prepaid portability type - `ppt`
- The appropriate `pc` parameter and value, according to the point code format
- The `ri=ssn` parameter
- If the `SETID` column is shown in the `rtrv-ppsopts` output in 2, the `setid` parameter must be specified with the `chg-ppsopts` command. The `setid` parameter value must be the MAP set ID that contains the point code value.
- The `ssn` parameter can be specified for this entry. If the `ssn` parameter is specified for this entry, the SSN value must be shown with the point code value in the `rtrv-map` output. If the `setid` parameter is specified, the point code and SSN values must be in the MAP set specified by the `setid` parameter.

For this example, enter this command.

```
chg-ppsopts:ppt=3:pca=001-001-004:ri=ssn:setid=2:ssn=25
```

When the `chg-ppsopts` command has successfully completed, this message should appear.

```
rlghncxa03w 08-09-07 11:44:13 GMT EAGLE5 39.1.0
CHG-PPSOPTS: MASP A - COMPLTD
```

8. Verify the changes using the `rtrv-ppsopts` command with the `ppt` parameter value specified in 7.

If a point code entry was removed in 7, for this example, enter this command.

```
rtrv-ppsopts:ppt=1
```

This is an example of the possible output.

```
rlghncxa03w 09-03-07 00:34:31 GMT EAGLE5 40.1.0
Prepaid SMS Options
-----
BPARTYCHK      = ON
PPT            PCA/PCI/PCN                SSN      RI      Set ID
---            -
1              -----                NONE     GT      DFLT
```

If a point code entry was added in 7, for this example, enter this command.

```
rtrv-ppsopts:ppt=3
```

This is an example of the possible output if the `RI` value is `GT`.

```
rlghncxa03w 09-03-07 00:34:31 GMT EAGLE5 40.1.0
Prepaid SMS Options
-----
BPARTYCHK      = ON
PPT            PCA/PCI/PCN                SSN      RI      Set ID
---            -
3              PCA: 001-001-004          NONE     GT      2
```

This is an example of the possible output if the `RI` value is `SSN`.

```
rlghncxa03w 09-03-07 00:34:31 GMT EAGLE5 40.1.0
Prepaid SMS Options
-----
BPARTYCHK      = ON
PPT            PCA/PCI/PCN                SSN      RI      Set ID
---            -
3              PCA: 001-001-004          25      SSN     2
```

9. Back up the new changes using the `chg-db:action=backup:dest=fixed` command. These messages should appear, the active Maintenance and Administration Subsystem Processor (MASP) appears first.

```
BACKUP (FIXED) : MASP A - Backup starts on active MASP.
BACKUP (FIXED) : MASP A - Backup on active MASP to fixed disk
complete.
BACKUP (FIXED) : MASP A - Backup starts on standby MASP.
```

BACKUP (FIXED) : MASP A - Backup on standby MASP to fixed disk complete.

If you do not wish to configure global title address (GTA) entries and the B-Party check option in the PPSOPTS table, this procedure is finished.

If you wish to configure global title address (GTA) entries and the B-Party check option in the PPSOPTS table, perform these procedures as applicable.

- To configure GTA entries, perform [Configuring GTA Entries for the Prepaid SMS Intercept Phase 1 Feature](#).
- To configure the B-Party check option, perform [Configuring the B-Party Check Option for the Prepaid SMS Intercept Phase 1 Feature](#).

Figure B-5 Configure Point Code Entries for the Prepaid SMS Intercept Phase 1 Feature - Sheet 1 of 3

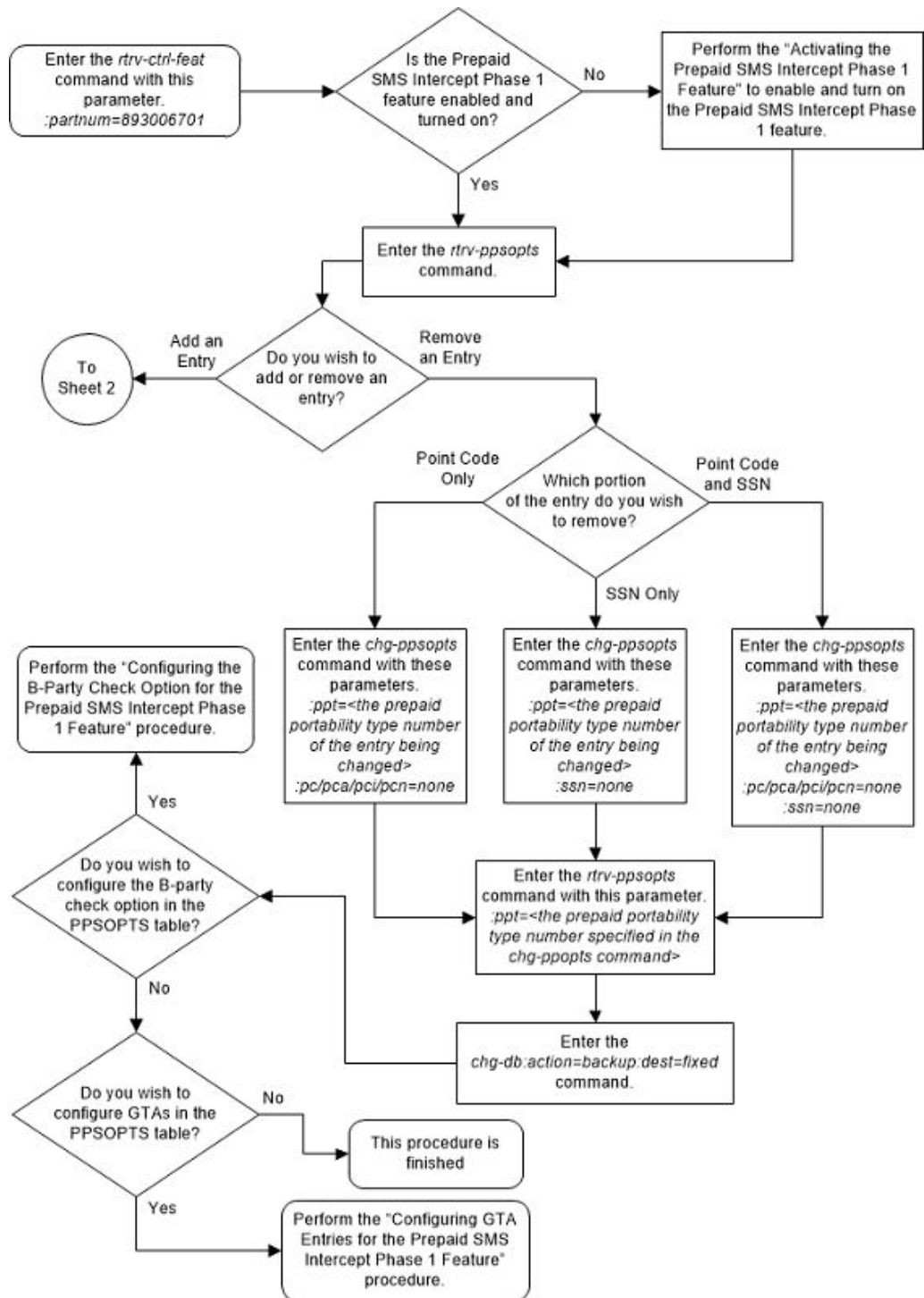

Figure B-6 Configure Point Code Entries for the Prepaid SMS Intercept Phase 1 Feature - Sheet 2 of 3

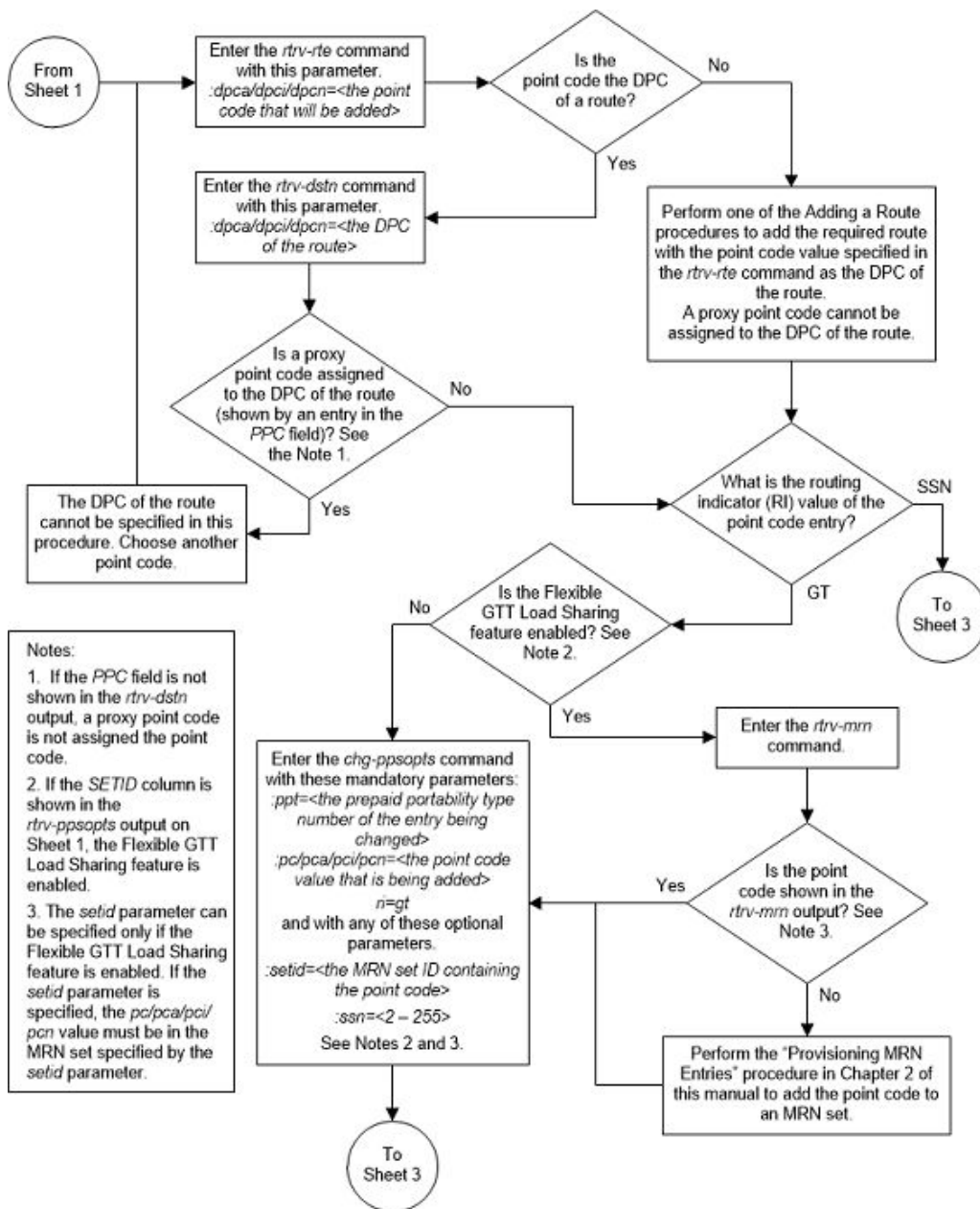
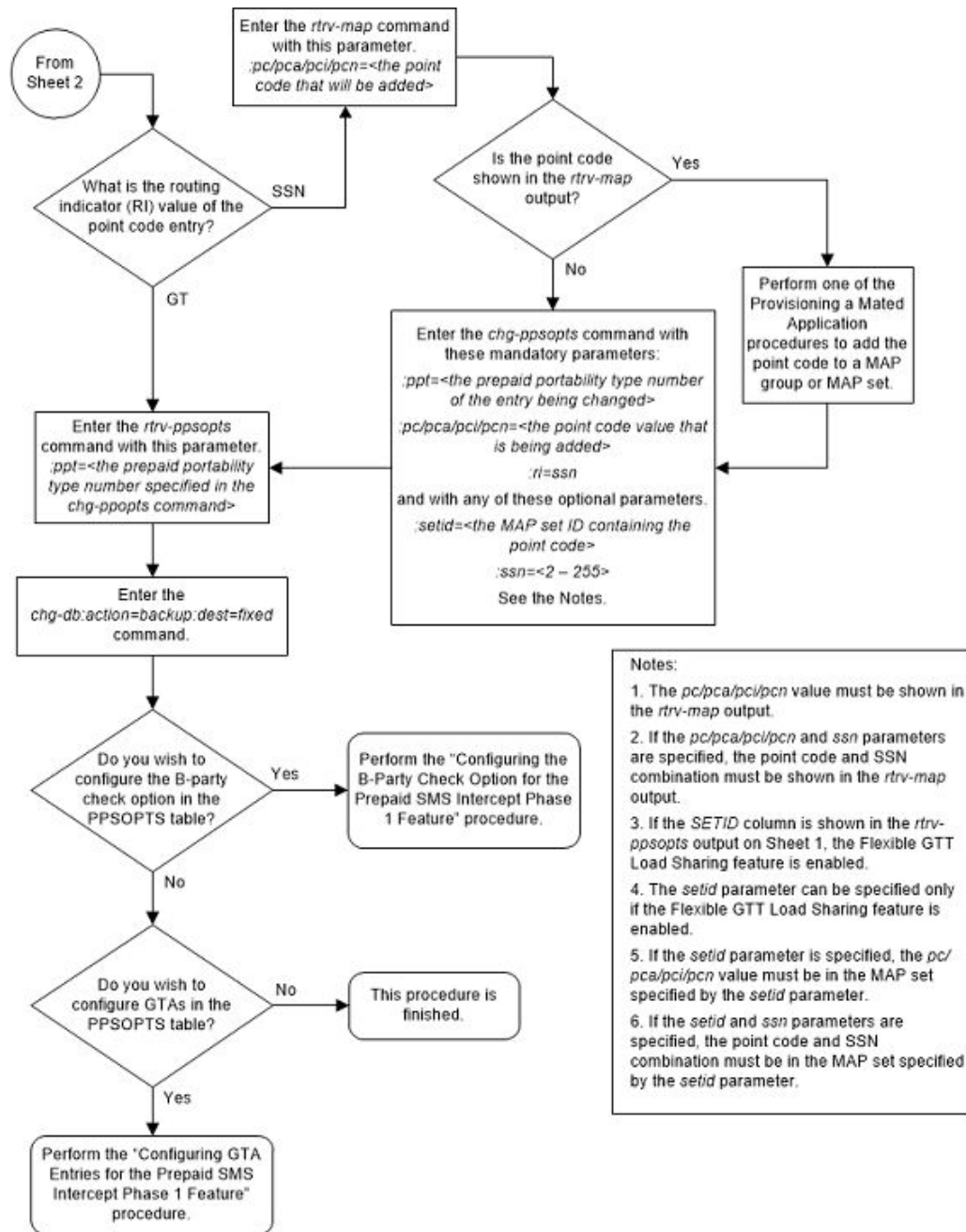

Figure B-7 Configure Point Code Entries for the Prepaid SMS Intercept Phase 1 Feature - Sheet 3 of 3



Configuring GTA Entries for the Prepaid SMS Intercept Phase 1 Feature

This procedure is used to add global title address (GTA) entries to the PPSOPTS table, remove GTA entries from the PPSOPTS table, or replace existing GTA entries with new GTA entries using these parameters of the `chg-ppspts` command.

:gta – The global title address that is being added, consisting of 1 to 15 digits, or the global title address that is being removed, shown in the `rtrv-ppsopts` output.

:gta1 – The global title address that is being added, consisting of 1 to 15 digits.

:gta2 – The global title address that is being added, consisting of 1 to 15 digits.

:gta3 – The global title address that is being added, consisting of 1 to 15 digits.

:ngta – The global title address value that replaces an existing GTA entry. If a new GTA being added, the `ngta` parameter value must contain 1 to 15 digit. If an existing GTA entry is being removed, the `ngta` parameter value must be `none`.

The GTA entry is the address for an IN platform and determines whether or not an incoming message is screening by the Prepaid SMS Intercept Phase 1 feature.

The PPSOPTS table can contain a maximum of 32 GTA entries. To remove or replace a GTA entry, a GTA entry must be shown in the `rtrv-ppsopts` output. To add GTA entries, blank GTA entries must be shown in the `rtrv-ppsopts` output.

A maximum of four GTA entries can be added with the `chg-ppsopts` command. To add more than four GTA entries to the PPSOPTS table, enter the `chg-ppsopts` command with the `gta`, `gta1`, `gta2`, and `gta3` parameters as needed to add the desired number of GTA entries, up to the maximum of 32 GTA entries.

Point code entries and the B-Party check option can also be configured with the `chg-ppsopts` command. Perform the procedure [Configuring the B-Party Check Option for the Prepaid SMS Intercept Phase 1 Feature](#) to configure the B-Party check option. Perform the procedure [Configuring Point Code Entries for the Prepaid SMS Intercept Phase 1 Feature](#) to configure the point code entries.

The Prepaid SMS Intercept Phase 1 feature must be enabled and turned on before this procedure can be performed. The status of the Prepaid SMS Intercept Phase 1 feature can be verified by entering the `rtrv-ctrl-feat` command. Perform the procedure [Activating the Prepaid SMS Intercept Phase 1 Feature](#) to enable and turn on the Prepaid SMS Intercept Phase 1 feature, if necessary.

1. Display the status of the Prepaid SMS Intercept Phase 1 feature by entering this command.

```
rtrv-ctrl-feat:partnum=893006701
```

The following is an example of the possible output.

```
rlghncxa03w 08-09-28 21:15:37 GMT EAGLE5 39.1.0
The following features have been permanently enabled:
```

Feature Name	Partnum	Status	Quantity
Prepaid SMS Intercept Ph1	893006701	on	----

The following features have been temporarily enabled:

Feature Name	Partnum	Status	Quantity	Trial
Period Left				
Zero entries found.				

The following features have expired temporary keys:

```
Feature Name          Partnum
Zero entries found.
```

If the Prepaid SMS Intercept Phase 1 feature is enabled and turned on, continue the procedure with 2.

If the Prepaid SMS Intercept Phase 1 feature is not enabled or not turned on, perform the procedure [Activating the Prepaid SMS Intercept Phase 1 Feature](#) to enable and turn on the Prepaid SMS Intercept Phase 1 feature. After the Prepaid SMS Intercept Phase 1 feature has been enabled and turned on, continue the procedure with 2.

2. Display the PPSOPTS table by entering the `rtrv-ppsopts` command. This is an example of the possible output..

```
rlghncxa03w 09-03-07 00:34:31 GMT EAGLE5 40.1.0
Prepaid SMS Options
-----
BPARTYCHK          = OFF
PPT          PCA/PCI/PCN          SSN          RI
---          -
1          PCA:    001-001-002          NONE          SSN
2          PCA:    001-002-003          NONE          GT
3          -----          NONE          GT
4          -----          NONE          GT
5          -----          NONE          GT
6          -----          NONE          GT
7          -----          NONE          GT
8          -----          NONE          GT
9          -----          NONE          GT
10         -----          NONE          GT
11         -----          NONE          GT
12         -----          NONE          GT
13         -----          NONE          GT
14         -----          NONE          GT
15         -----          NONE          GT
16         -----          NONE          GT
17         -----          NONE          GT
18         -----          NONE          GT
19         -----          NONE          GT
20         -----          NONE          GT
21         -----          NONE          GT
22         -----          NONE          GT
23         -----          NONE          GT
24         -----          NONE          GT
25         -----          NONE          GT
26         -----          NONE          GT
27         -----          NONE          GT
28         -----          NONE          GT
29         -----          NONE          GT
30         -----          NONE          GT
31         -----          NONE          GT
32         -----          NONE          GT
```

GTA

shown in the `rtrv-ppsopts` output. The new GTA value cannot be shown in the `rtrv-ppsopts` output. For this example, enter this command.

```
chg-ppsopts:gta=910461:ngta=910527
```

- c. To remove an existing GTA entry, enter the `chg-ppsopts` command with the `gta` and `ngta=none` parameters. The GTA value that is being removed must be shown in the `rtrv-ppsopts` output. For this example, enter this command.

```
chg-ppsopts:gta=910460:ngta=none
```

When the `chg-ppsopts` command has successfully completed, this message should appear.

```
rlghncxa03w 08-09-07 11:44:13 GMT EAGLE5 39.1.0
CHG-PPSOPTS: MASP A - COMPLTD
```

4. Verify the changes by entering the `rtrv-ppsopts` command. This is an example of the possible output.

```
rlghncxa03w 09-03-07 00:34:31 GMT EAGLE5 40.1.0
Prepaid SMS Options
-----
BPARTYCHK      = OFF
PPT            PCA/PCI/PCN                SSN      RI
---            -
1             PCA:    001-001-002                NONE     SSN
2             PCA:    001-002-003                NONE     GT
3             -----                NONE     GT
4             -----                NONE     GT
5             -----                NONE     GT
6             -----                NONE     GT
7             -----                NONE     GT
8             -----                NONE     GT
9             -----                NONE     GT
10            -----                NONE     GT
11            -----                NONE     GT
12            -----                NONE     GT
13            -----                NONE     GT
14            -----                NONE     GT
15            -----                NONE     GT
16            -----                NONE     GT
17            -----                NONE     GT
18            -----                NONE     GT
19            -----                NONE     GT
20            -----                NONE     GT
21            -----                NONE     GT
22            -----                NONE     GT
23            -----                NONE     GT
24            -----                NONE     GT
25            -----                NONE     GT
26            -----                NONE     GT
27            -----                NONE     GT
28            -----                NONE     GT
29            -----                NONE     GT
```

- To configure point code entries, perform the procedure [Configuring Point Code Entries for the Prepaid SMS Intercept Phase 1 Feature](#).
- To configure the B-Party check option, perform the procedure [Configuring the B-Party Check Option for the Prepaid SMS Intercept Phase 1 Feature](#).

Figure B-8 Configure GTA Entries for the Prepaid SMS Intercept Phase 1 Feature - Sheet 1 of 2

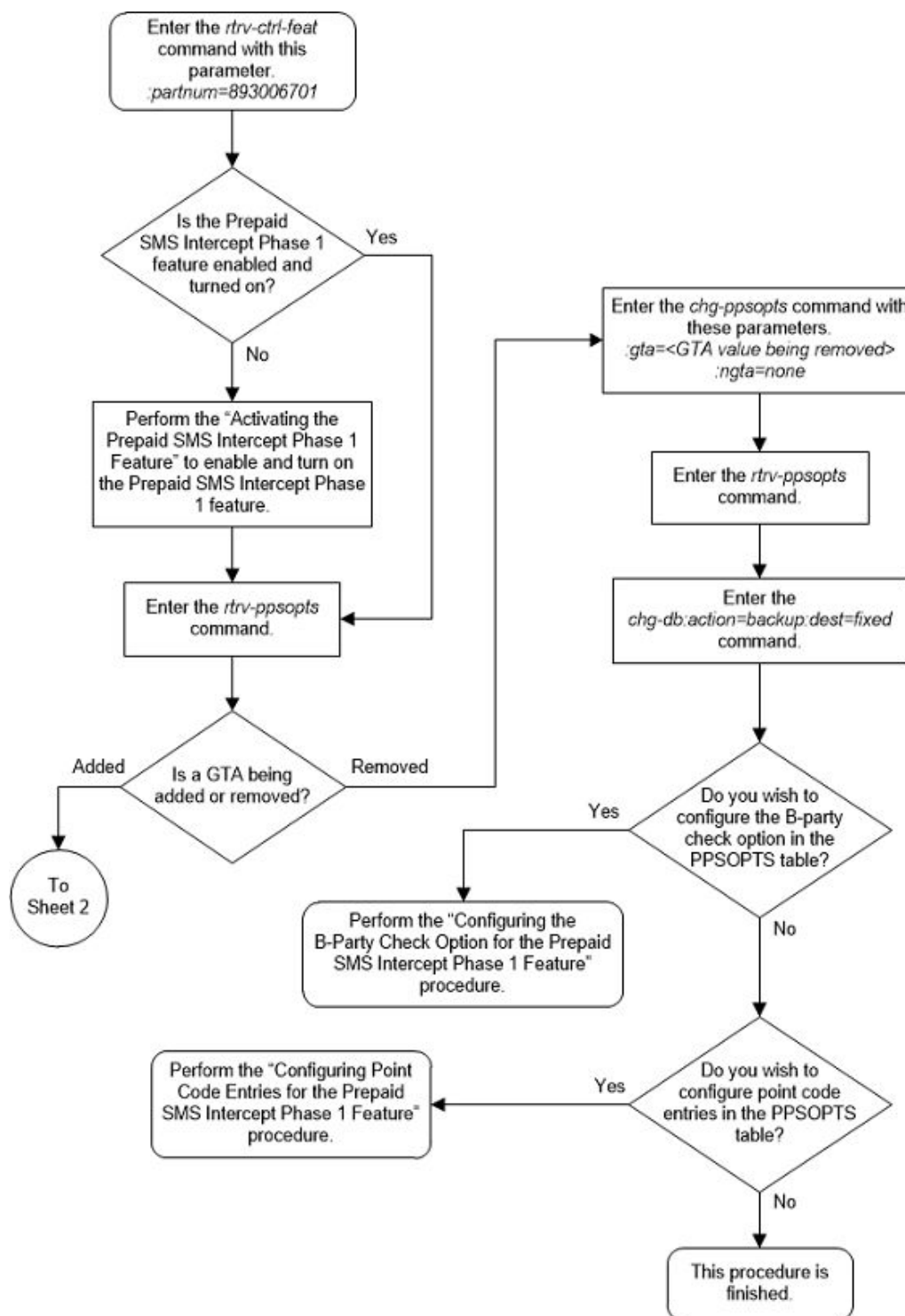
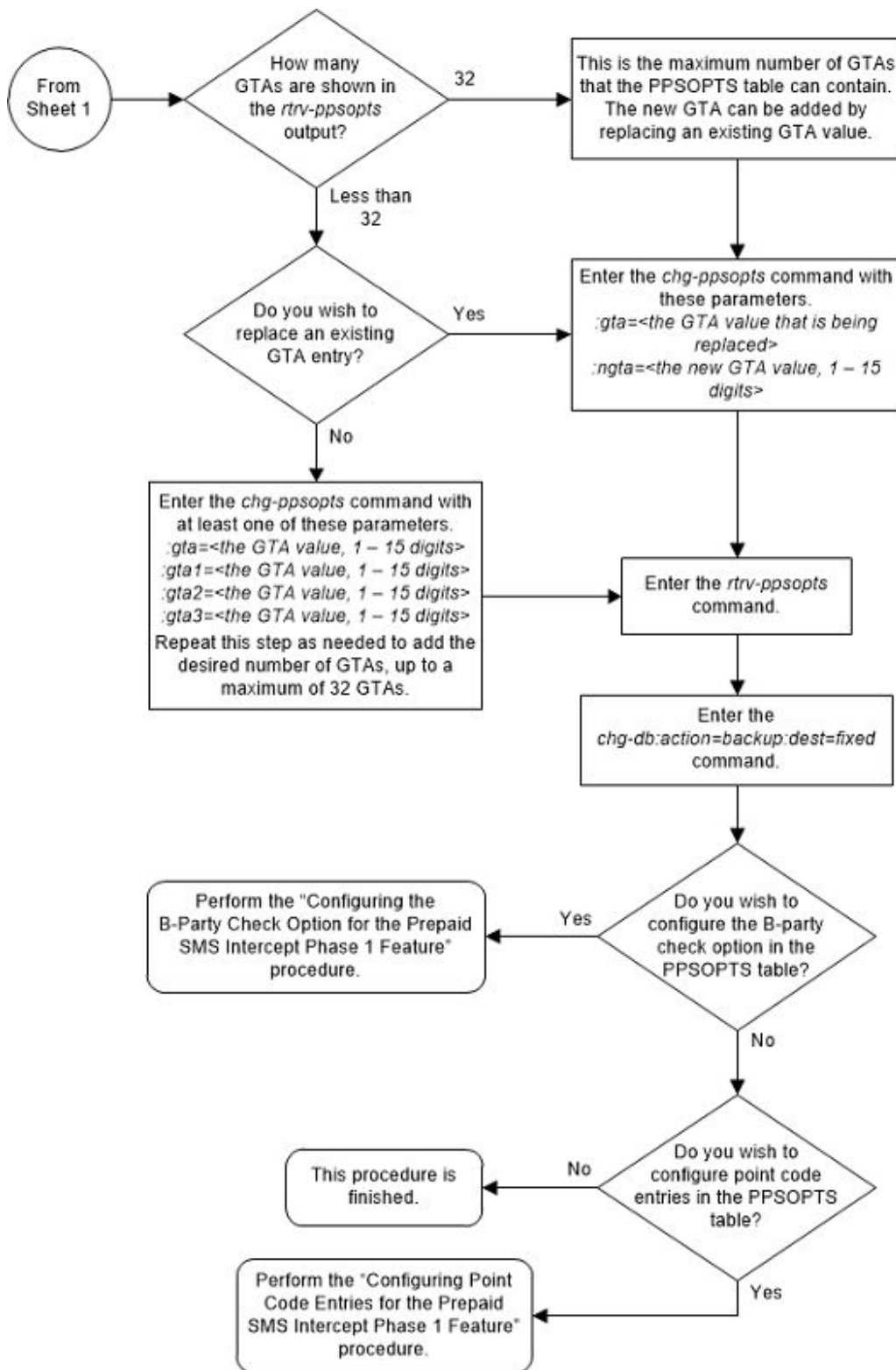

Figure B-9 Configure GTA Entries for the Prepaid SMS Intercept Phase 1 Feature - Sheet 2 of 2



Turning Off the Prepaid SMS Intercept Phase 1 Feature

This procedure is used to turn off the Prepaid SMS Intercept Phase 1 feature, using the `chg-ctrl-feat` command.

The `chg-ctrl-feat` command uses the following parameters:

`:partnum` - The part number of the Prepaid SMS Intercept Phase 1, 893006701.

`:status=off` – used to turn off the Prepaid SMS Intercept Phase 1 feature.

The status of the Prepaid SMS Intercept Phase 1 feature must be `on` and is shown with the `rtrv-ctrl-feat` command.

Caution:

If the Prepaid SMS Intercept Phase 1 feature is turned off, the screening of incoming messages from an MSC by the EAGLE based on the MAP operation code will not be performed.

1. Display the status of the Prepaid SMS Intercept Phase 1 feature by entering the `rtrv-ctrl-feat:partnum=893006701` command.

The following is an example of the possible output.

```
rlghncxa03w 08-09-28 21:15:37 GMT EAGLE5 39.1.0
```

The following features have been permanently enabled:

Feature Name	Partnum	Status	Quantity
Prepaid SMS Intercept Ph1	893006701	on	----

The following features have been temporarily enabled:

Feature Name	Partnum	Status	Quantity	Trial
Period Left				
Zero entries found.				

The following features have expired temporary keys:

Feature Name	Partnum
Zero entries found.	

If the status of the Prepaid SMS Intercept Phase 1 is `off`, or if the Prepaid SMS Intercept Phase 1 is not enabled, this procedure cannot be performed.

2. Turn off the Prepaid SMS Intercept Phase 1 by entering the `chg-ctrl-feat` command with the `status=off` parameter.

For example, enter this command.

```
chg-ctrl-feat:partnum=893006701:status=off
```

When this command has successfully completed, the following message should appear.

```
rlghncxa03w 08-09-28 21:16:37 GMT EAGLE5 39.1.0
CHG-CTRL-FEAT: MASP A - COMPLTD
```

3. Verify that the Prepaid SMS Intercept Phase 1 has been turned off by using the `rtrv-ctrl-feat:partnum=893006701` command. The following is an example of the possible output.

```
rlghncxa03w 08-09-28 21:15:37 GMT EAGLE5 39.1.0
The following features have been permanently enabled:
```

Feature Name	Partnum	Status	Quantity
Prepaid SMS Intercept Ph1	893006701	off	----

The following features have been temporarily enabled:

Feature Name	Partnum	Status	Quantity	Trial Period Left
Zero entries found.				

The following features have expired temporary keys:

Feature Name	Partnum
Zero entries found.	

4. Back up the new changes using the `chg-db:action=backup:dest=fixed` command.

These messages should appear, the active Maintenance and Administration Subsystem Processor (MASP) appears first.

```
BACKUP (FIXED) : MASP A - Backup starts on active MASP.
BACKUP (FIXED) : MASP A - Backup on active MASP to fixed disk
complete.
BACKUP (FIXED) : MASP A - Backup starts on standby MASP.
BACKUP (FIXED) : MASP A - Backup on standby MASP to fixed disk
complete.
```

Figure B-10 Turn Off the Prepaid SMS Intercept Phase 1 Feature

